

US00D822310S

(12) **United States Design Patent**
Michel et al.

(10) **Patent No.:** **US D822,310 S**
(45) **Date of Patent:** **** Jul. 10, 2018**

- (54) **SALT BLOCK**
- (71) Applicant: **ESCO—European Salt Company GmbH & Co., KG, Hannover (DE)**
- (72) Inventors: **Evelyne Michel, Levallois-Perret (FR); Thorsten Kopp, Hannover (DE)**
- (73) Assignee: **ESCO—European Salt Company GmbH & Co., KG, Hannover (DE)**
- (**) Term: **15 Years**
- (21) Appl. No.: **29/594,793**
- (22) Filed: **Feb. 22, 2017**
- (51) **LOC (11) Cl.** **01-01**
- (52) **U.S. Cl.**
USPC **D1/100**
- (58) **Field of Classification Search**
USPC D1/100–130, 199; 426/104, 108, 138, 426/391, 549, 808, 94, 143, 559, 560; D24/101–104; D28/8.1, 63; D6/601; D32/40, 43; D9/707, 756; D30/160; D18/56; D25/113, 115; D23/366
CPC A23G 3/50; A23G 3/54; A23J 3/26; A23L 1/0067; B41J 2/17593
See application file for complete search history.

- 3,071,476 A * 1/1963 Werft A23G 3/50 131/270
- D206,429 S * 12/1966 Eckelman D1/121
- D226,595 S * 4/1973 Caunas D1/121
- D310,130 S * 8/1990 van Kooten D1/100
- D372,270 S * 7/1996 Jones D18/56
- D375,950 S * 11/1996 Jones D14/137
- D383,153 S * 9/1997 Jones D18/56
- D415,193 S * 10/1999 Jones 347/88
- 5,988,805 A * 11/1999 Meinhardt B41J 2/17593 347/88
- D512,784 S * 12/2005 Quintana D25/115
- D519,711 S * 5/2006 Dreano D1/121

* cited by examiner

Primary Examiner — Katie Jane Stofko
(74) *Attorney, Agent, or Firm* — Oblon, McClelland, Maier & Neustadt, L.L.P.

(57) **CLAIM**

The ornamental design for a salt block, as shown and described.

DESCRIPTION

FIG. 1 is a front, top, and left side perspective view of a salt block;
FIG. 2 is a front elevational view thereof;
FIG. 3 is a rear elevational view thereof;
FIG. 4 is a right side elevational view thereof;
FIG. 5 is a left side elevational view thereof;
FIG. 6 is a top plan view thereof; and,
FIG. 7 is a bottom plan view thereof.

(56) **References Cited**

U.S. PATENT DOCUMENTS

- D99,590 S * 5/1936 Torongo D1/100
- D127,285 S * 5/1941 Siemund D1/121

1 Claim, 6 Drawing Sheets

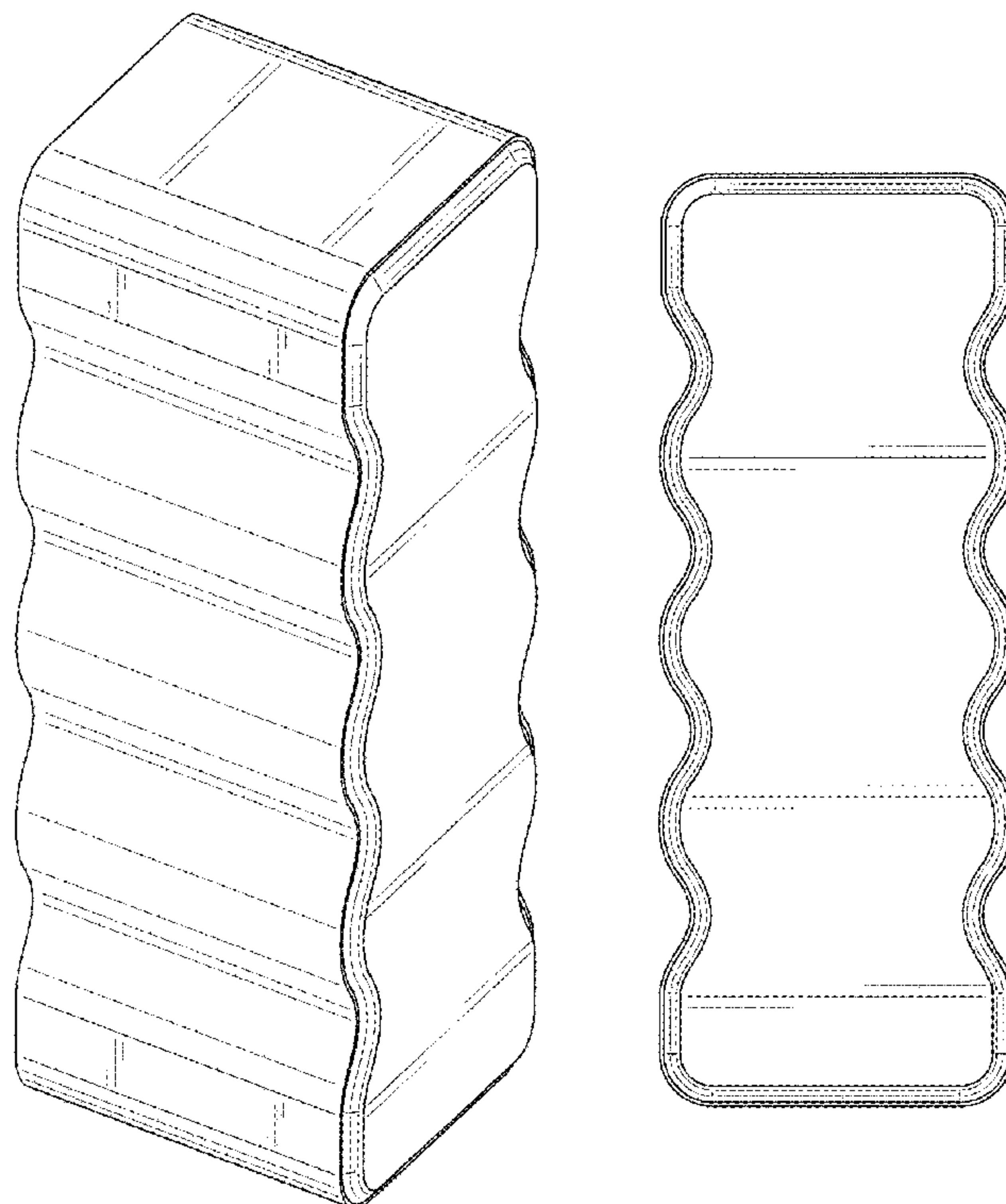

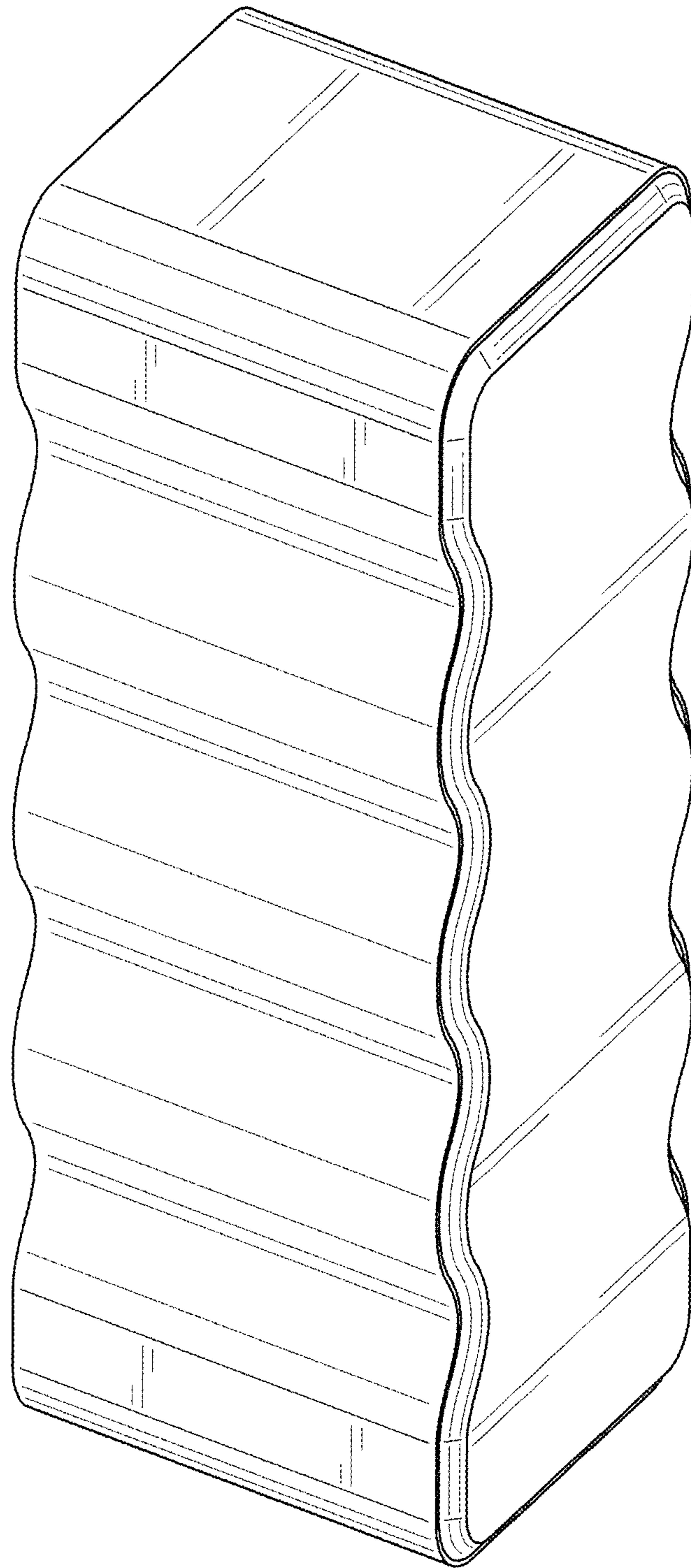

FIG. 1

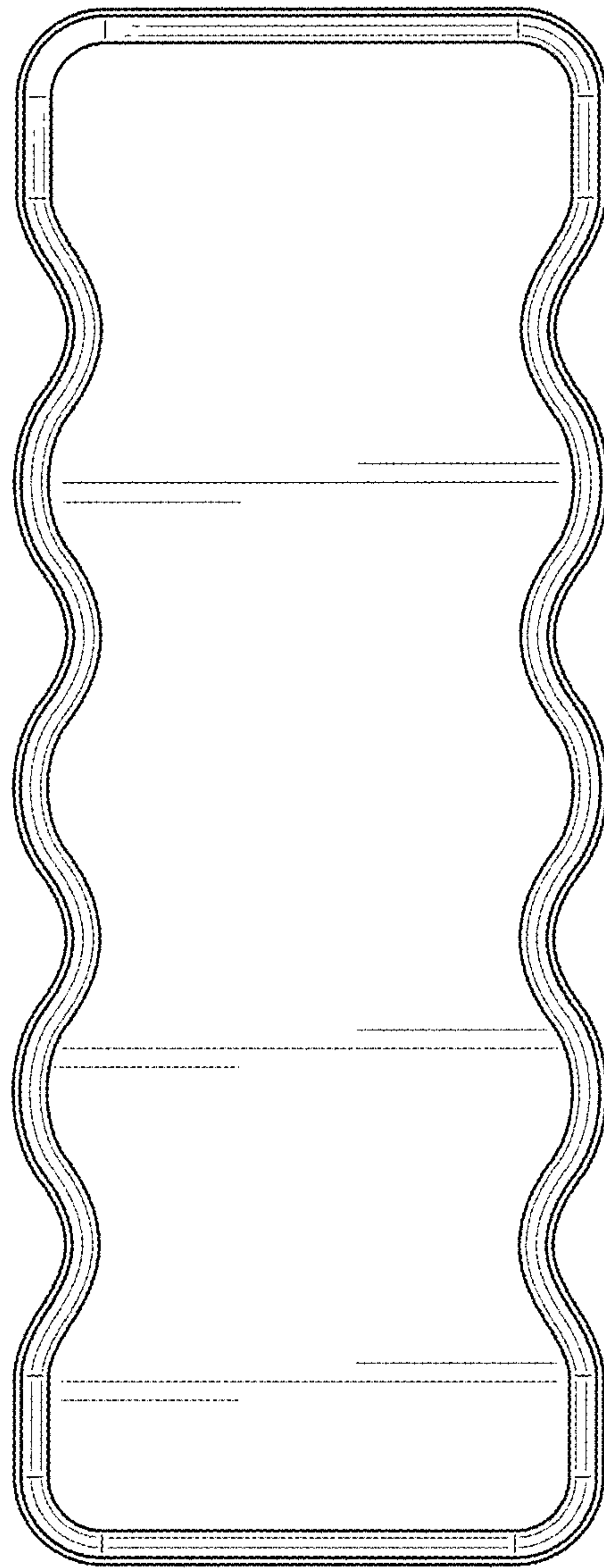

FIG. 2

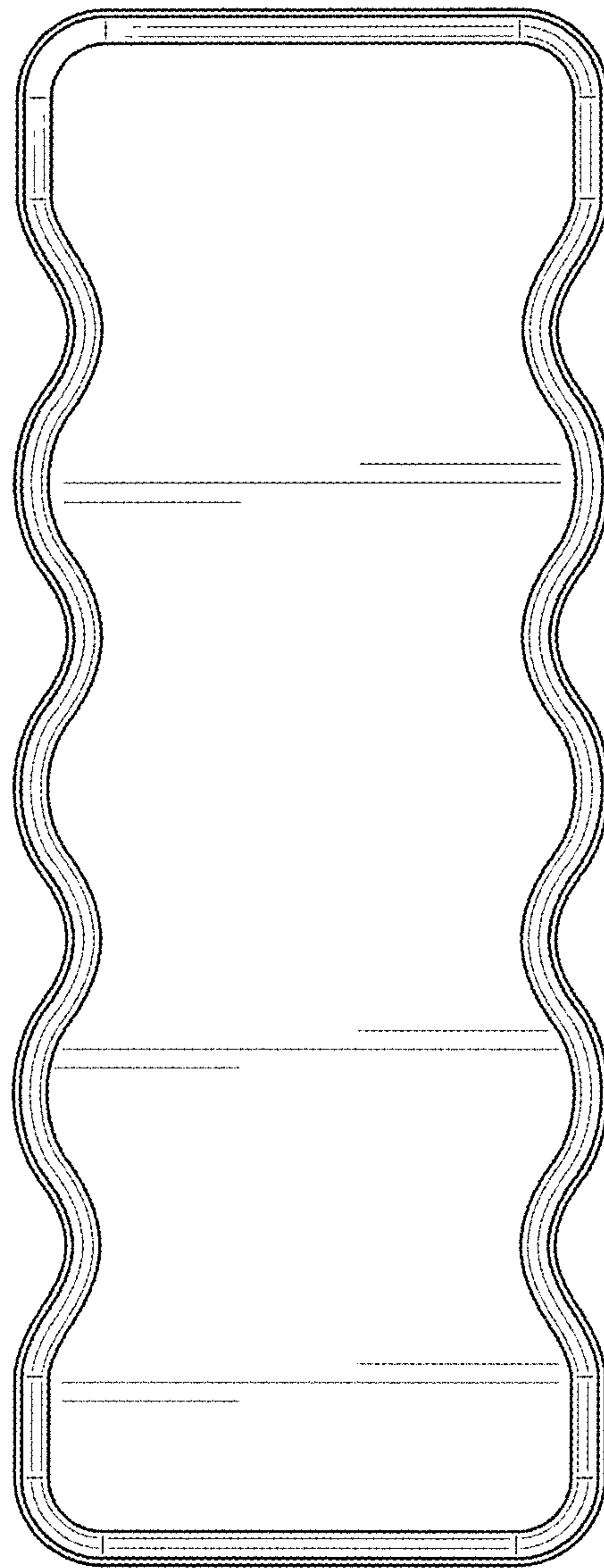

FIG. 3

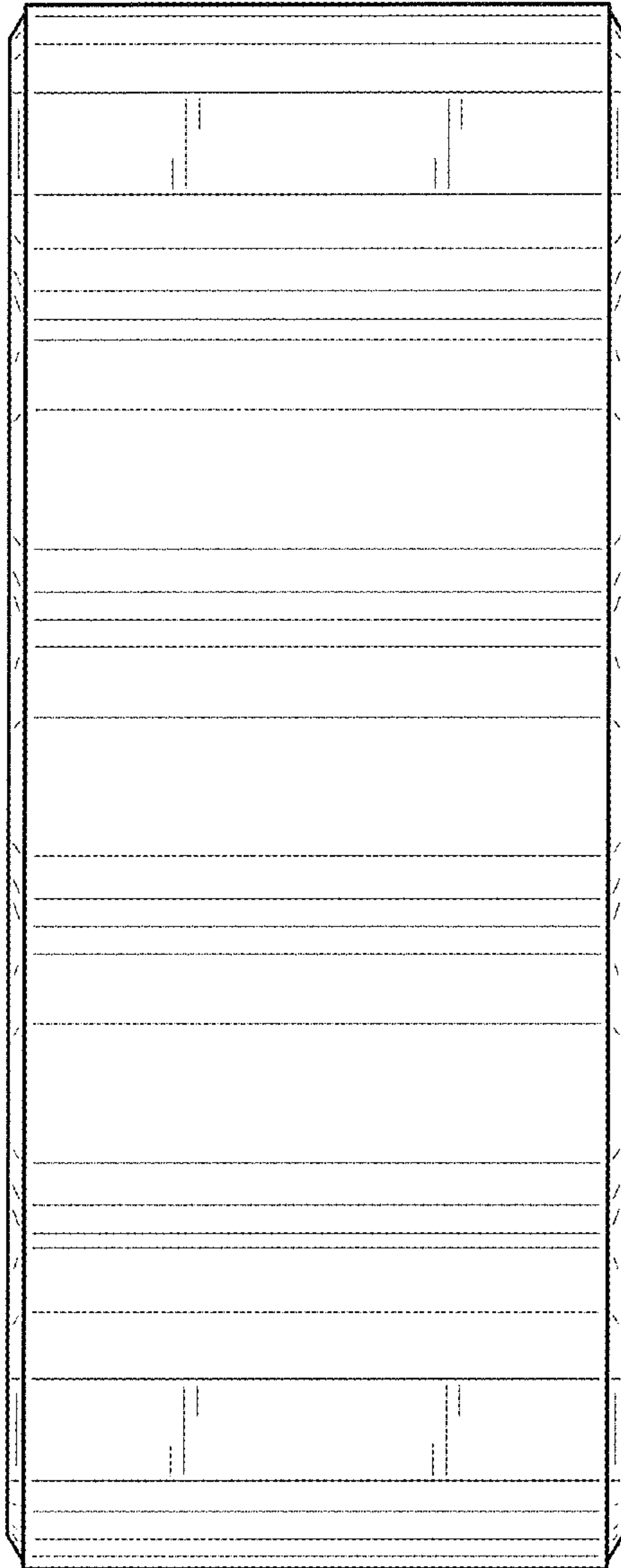

FIG. 4

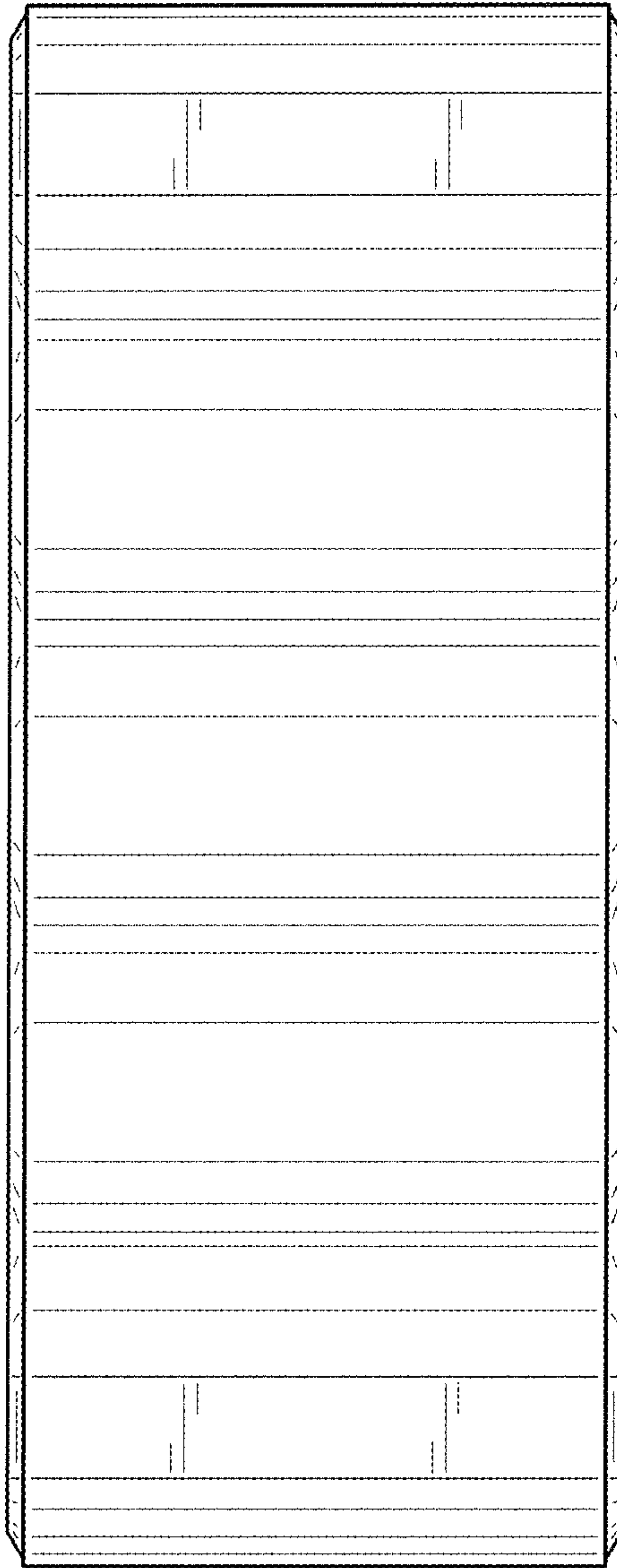

FIG. 5

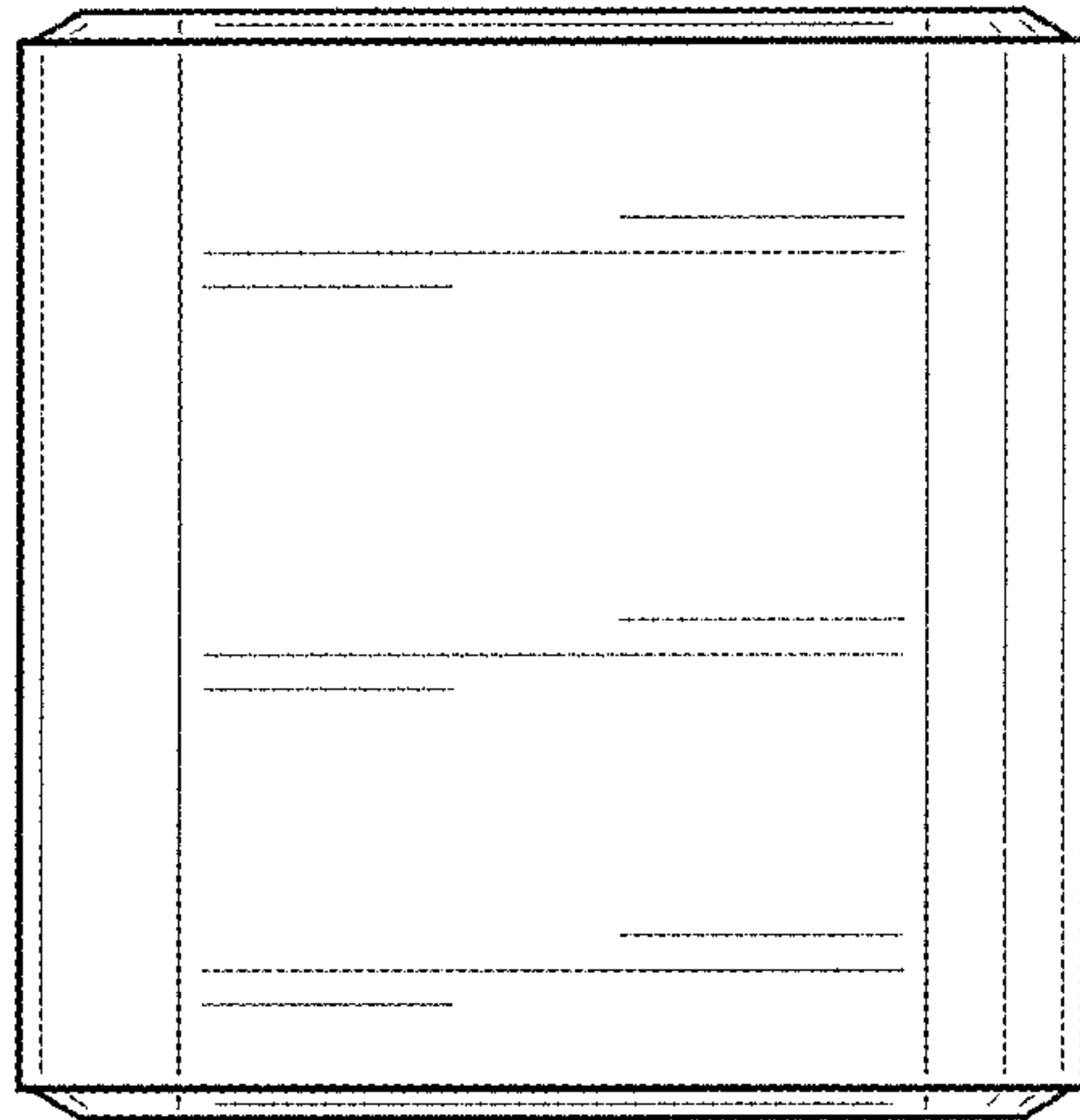

FIG. 6

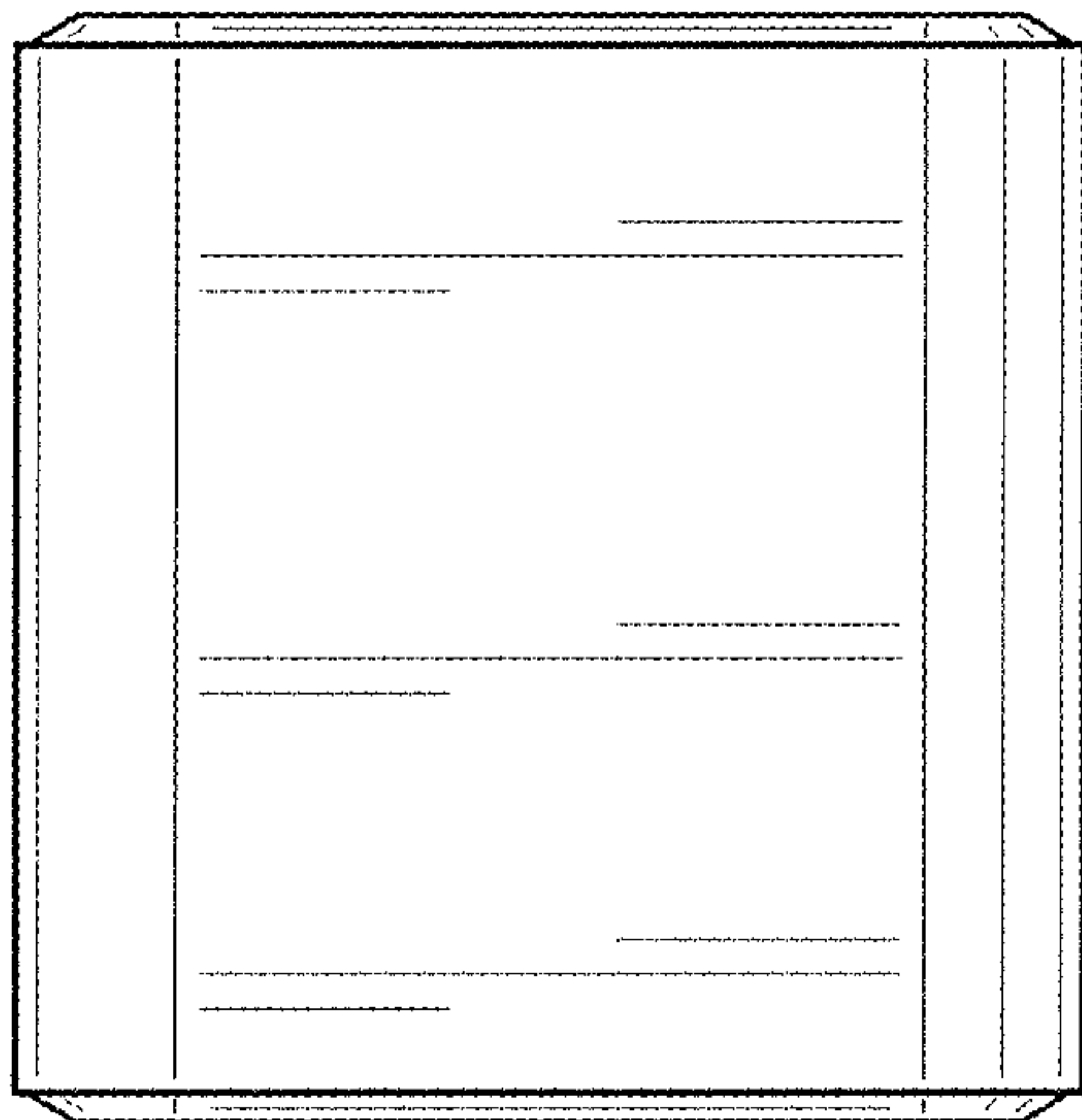

FIG. 7