



US00D822214S

(12) **United States Design Patent** (10) **Patent No.:** **US D822,214 S**  
**Iles et al.** (45) **Date of Patent:** **\*\* Jul. 3, 2018**

(54) **MEDICAL MONITOR**  
(71) Applicant: **HUNTLEIGH TECHNOLOGY LIMITED**, Dunstable (GB)  
(72) Inventors: **John Albert David Iles**, Cardiff (GB); **David Gillman Barber**, Gwent (GB); **Francis Gregory Baily**, Cardiff (GB); **Douglas Blake**, Porthcawl (GB); **David Stanger**, Monmouthshire (GB)

(73) Assignee: **Huntleigh Technology Limited**, Bedfordshire, Dunstable (GB)

(\*\*) Term: **15 Years**

(21) Appl. No.: **29/545,839**

(22) Filed: **Nov. 16, 2015**

(51) **LOC (11) Cl.** ..... **24-01**

(52) **U.S. Cl.**  
USPC ..... **D24/186**

(58) **Field of Classification Search**  
USPC ..... D24/107, 186, 165-169, 231, 232; D14/485-487, 451, 371, 374, 375, 328, D14/336, 339, 340; D10/70, 75, 78, 81, D10/96  
CPC . A61B 5/0205; A61B 5/02055; A61B 5/0002; A61B 5/0006; A61B 5/0008; A61B 5/002; A61B 5/0022; A61B 2560/0431; A61B 2560/0443; A61B 2560/045; A61B 2560/0456  
See application file for complete search history.

(56) **References Cited**

**U.S. PATENT DOCUMENTS**

6,188,407 B1 \* 2/2001 Smith ..... A61B 5/044 345/902  
D459,813 S \* 7/2002 Ramsey, III ..... D14/336

D497,995 S \* 11/2004 Baily ..... D24/186  
D616,100 S \* 5/2010 Moscovita ..... D24/169  
D621,511 S \* 8/2010 Lathrop ..... D24/167  
D635,681 S \* 4/2011 Edwards ..... D24/186  
D739,031 S \* 9/2015 Golden ..... D24/186  
D760,766 S \* 7/2016 Repka ..... D14/487  
D762,863 S \* 8/2016 Kim ..... D24/186  
2011/0054267 A1 \* 3/2011 Fidacaro ..... A61B 5/0002 600/300  
2013/0267861 A1 \* 10/2013 Vassallo ..... G06F 19/3406 600/532

\* cited by examiner

*Primary Examiner* — Anhdao Doan

(74) *Attorney, Agent, or Firm* — The Webb Law Firm

(57) **CLAIM**

The ornamental design for a medical monitor, as shown and described.

**DESCRIPTION**

FIG. 1 is a front perspective view of a medical monitor, showing our new design.  
FIG. 2 is a side perspective view of the monitor of FIG. 1.  
FIG. 3 is a front view of the monitor of FIG. 1.  
FIG. 4 is a first side view of the monitor of FIG. 1.  
FIG. 5 is a second side view of the monitor of FIG. 1.  
FIG. 6 is a rear view of the monitor of FIG. 1.  
FIG. 7 is a perspective rear view of the monitor of FIG. 1.  
FIG. 8 is a top view of the monitor of FIG. 1; and, FIG. 9 is a bottom view of the monitor of FIG. 1.  
The dot-dash lines and the dash-dash lines immediately adjacent to the shaded areas represent the bounds of the claim, while all other broken lines are directed to environment and are for illustrative purposes only. The broken lines form no part of the claimed design.

**1 Claim, 9 Drawing Sheets**

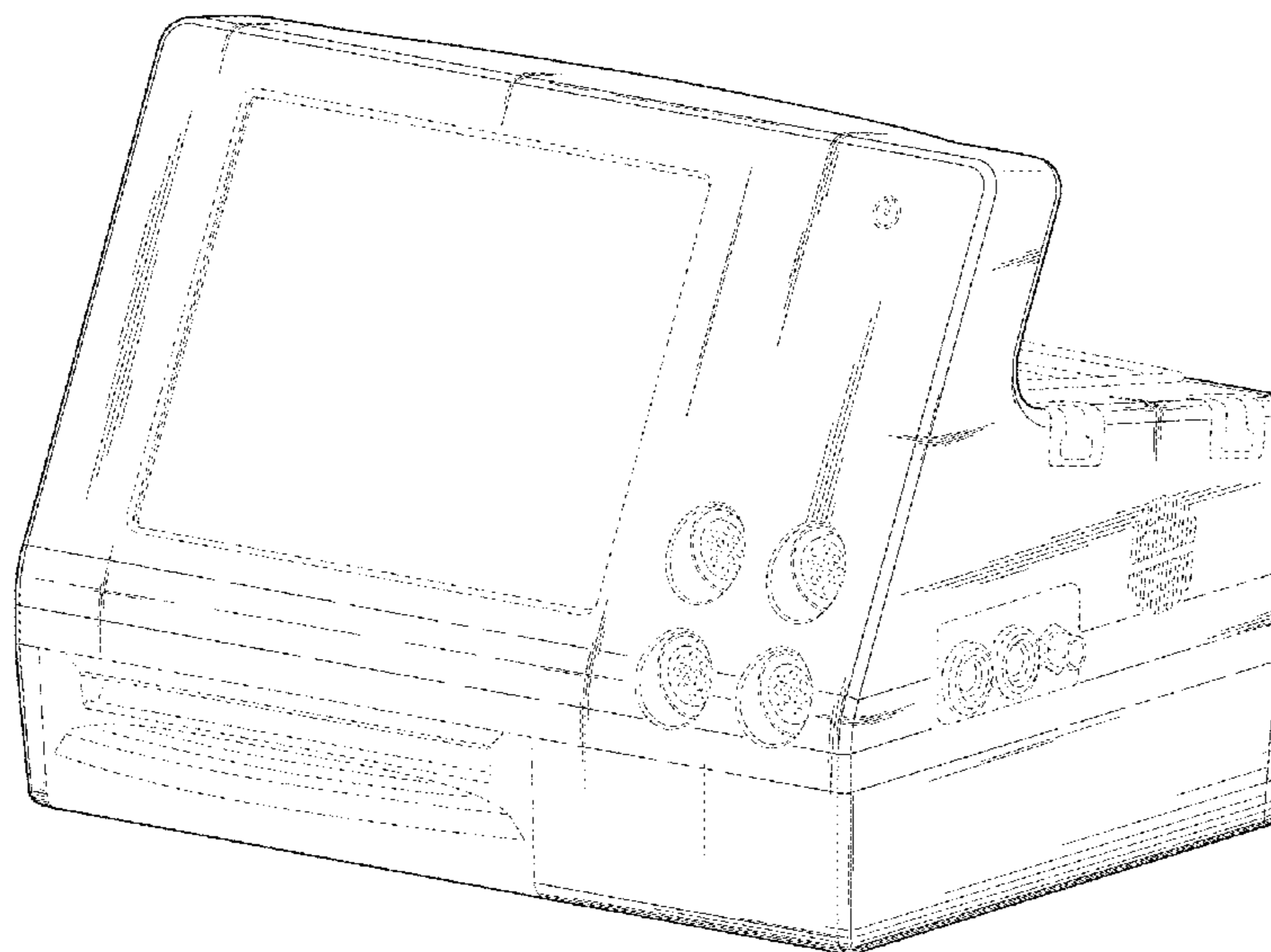

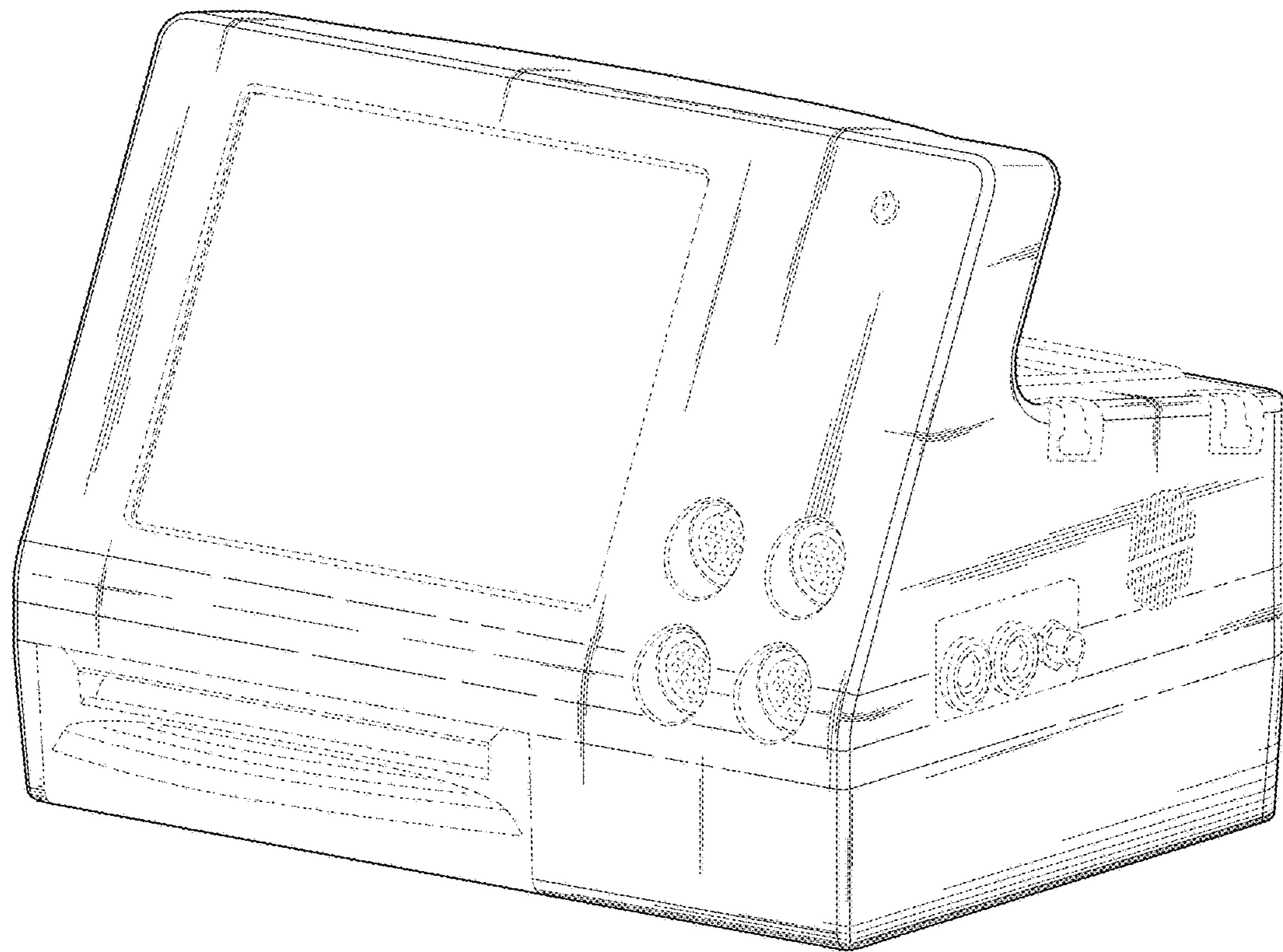

**FIG. 1**

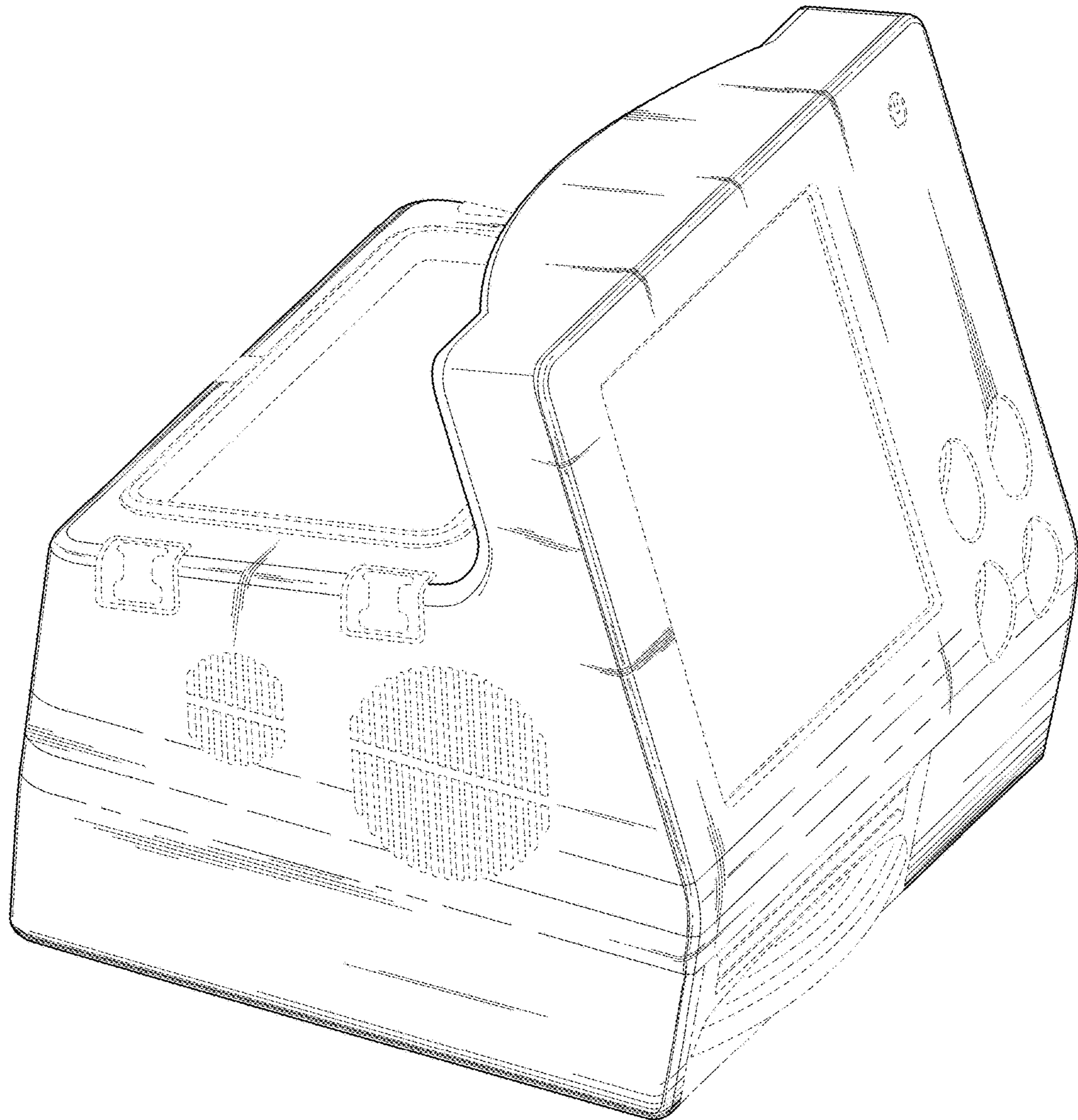

**FIG. 2**



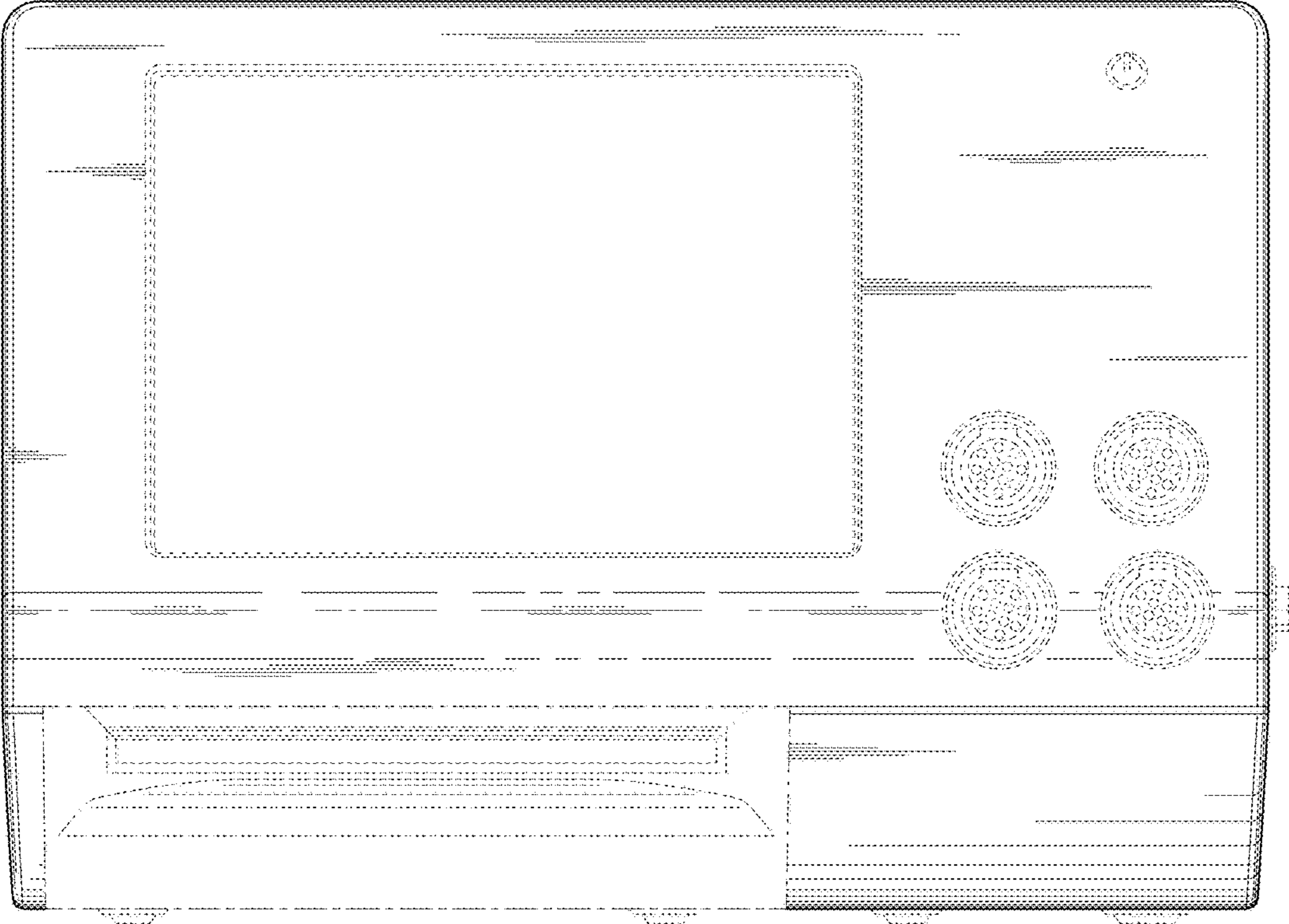

FIG. 3

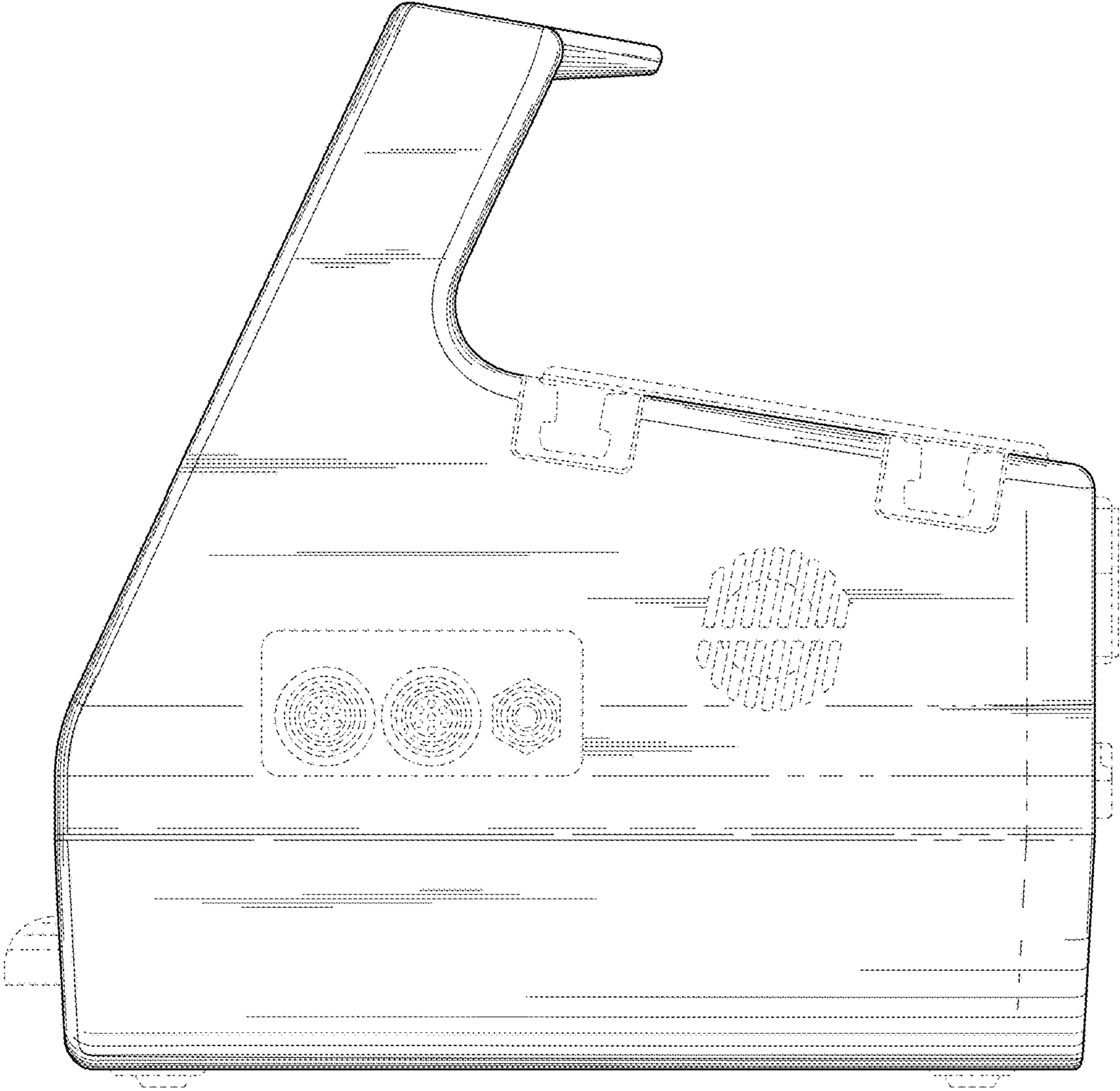
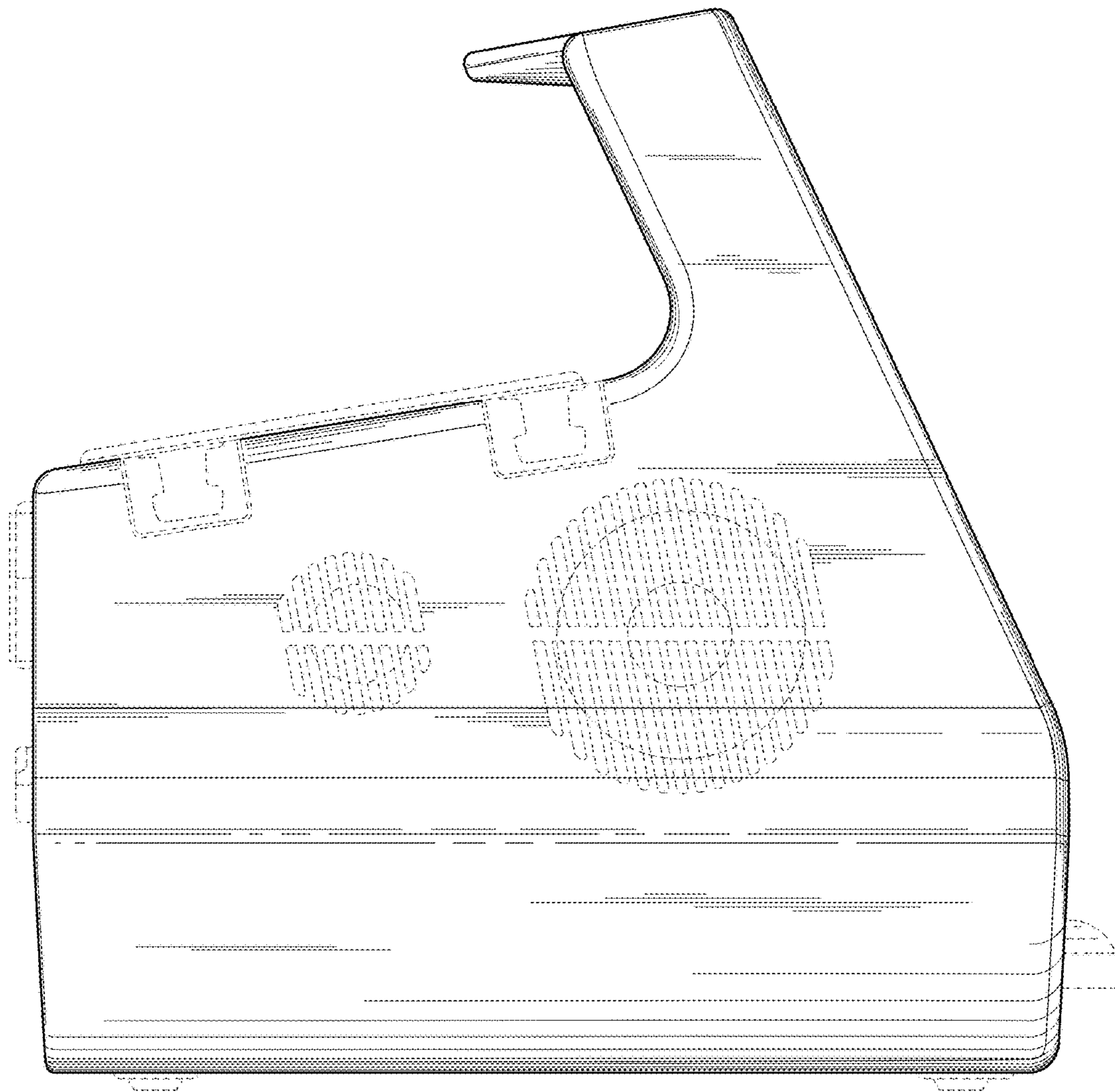

FIG. 4



**FIG. 5**

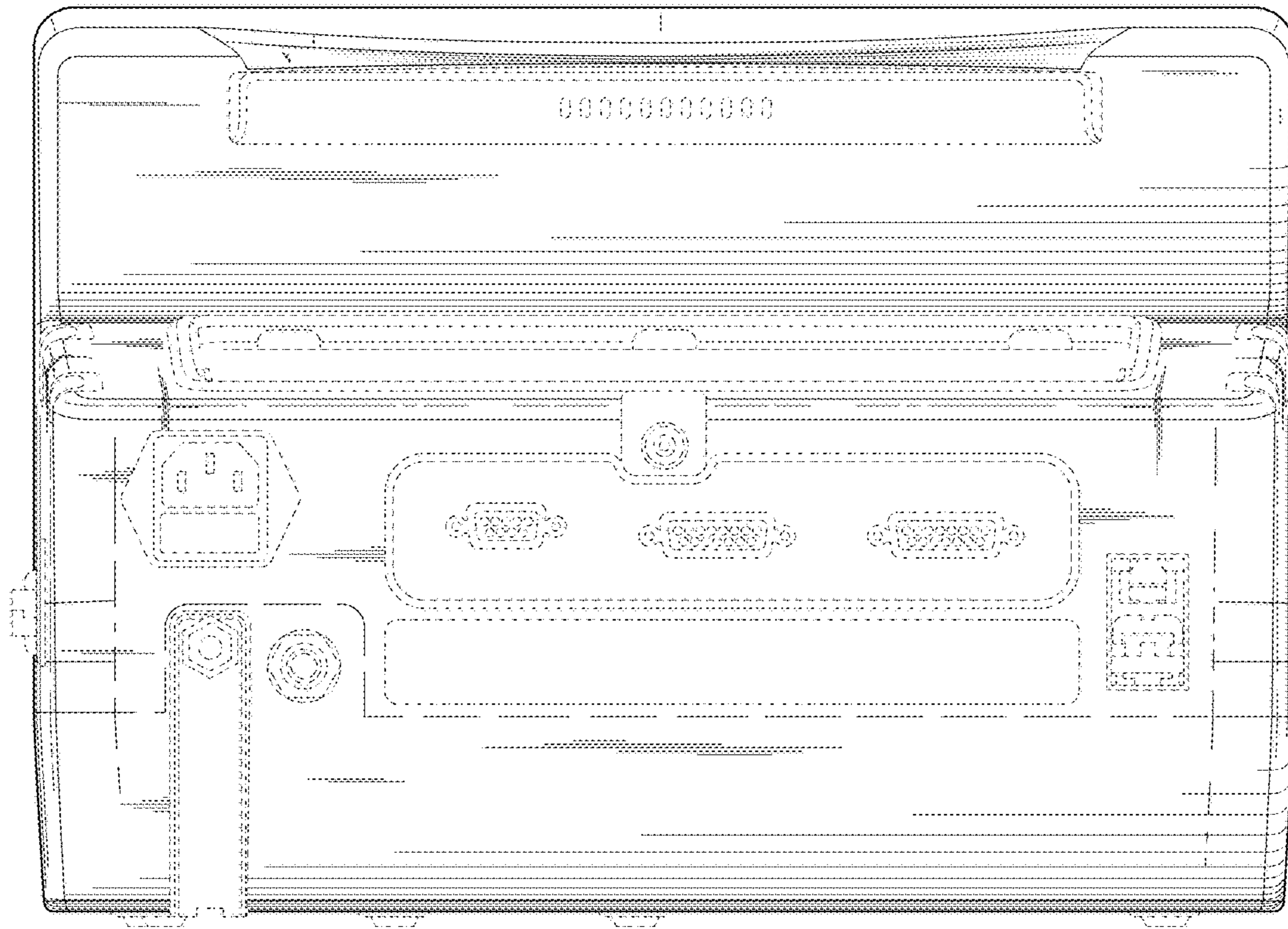
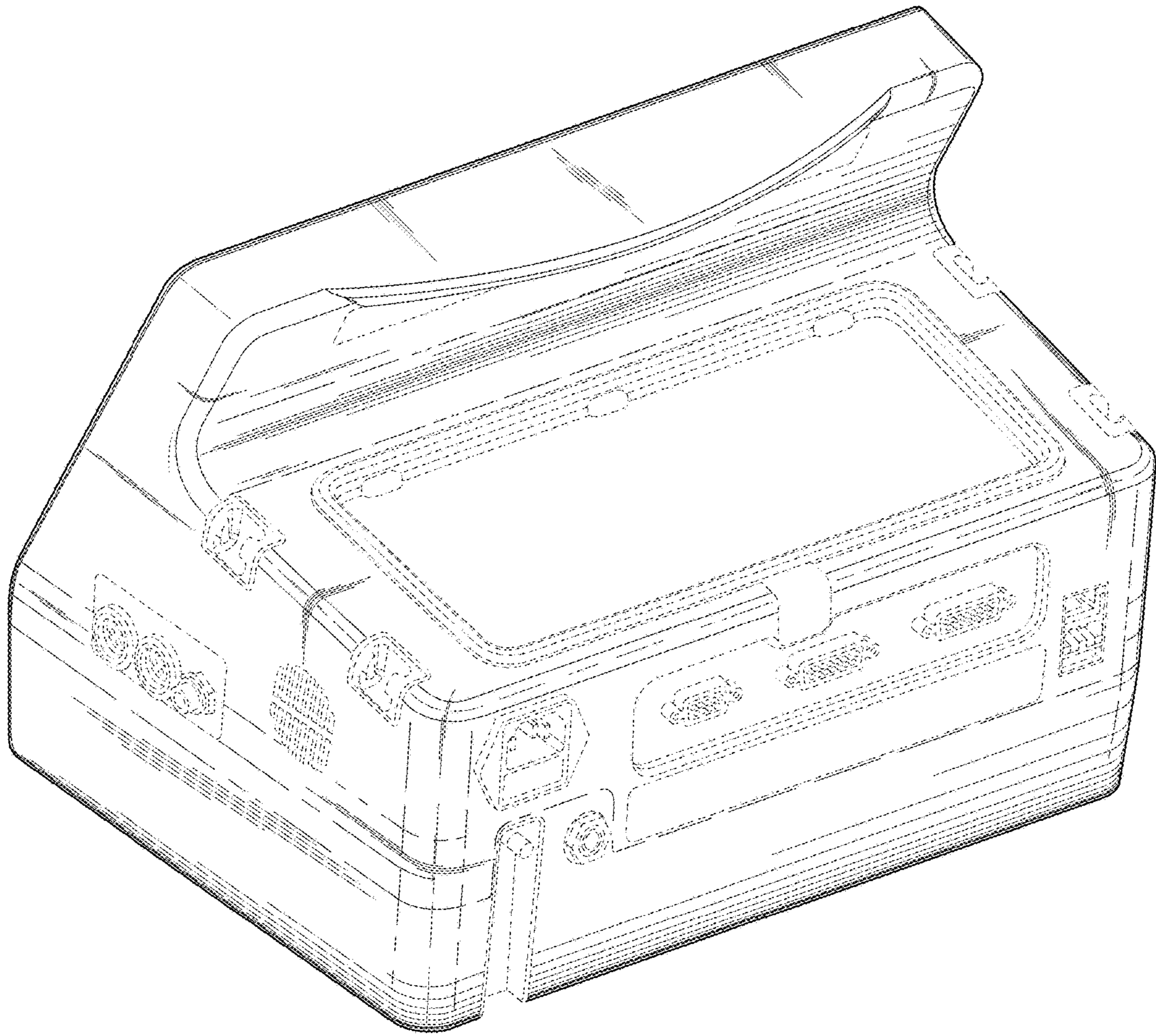

FIG. 6





**FIG. 7**



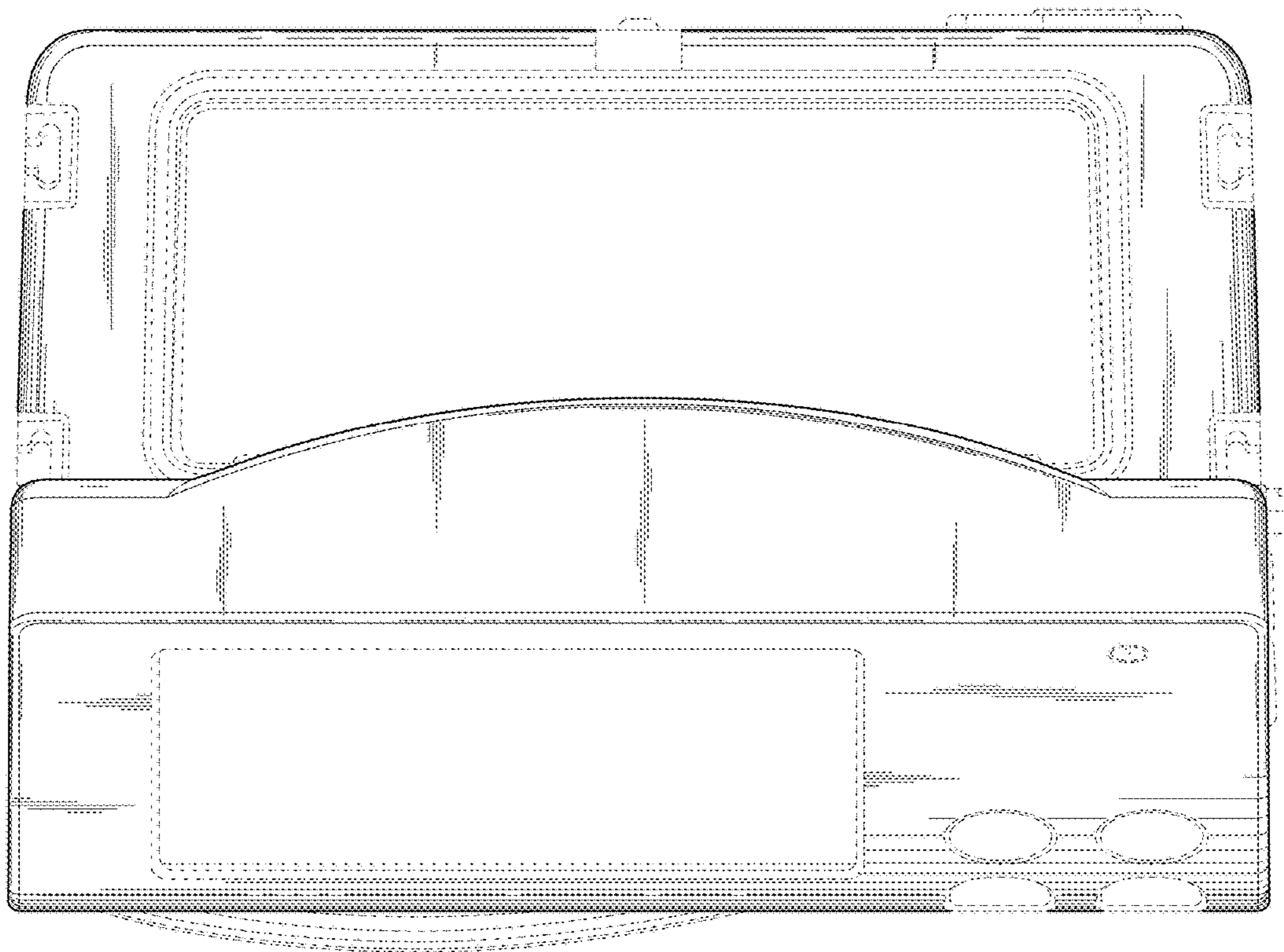

**FIG. 8**

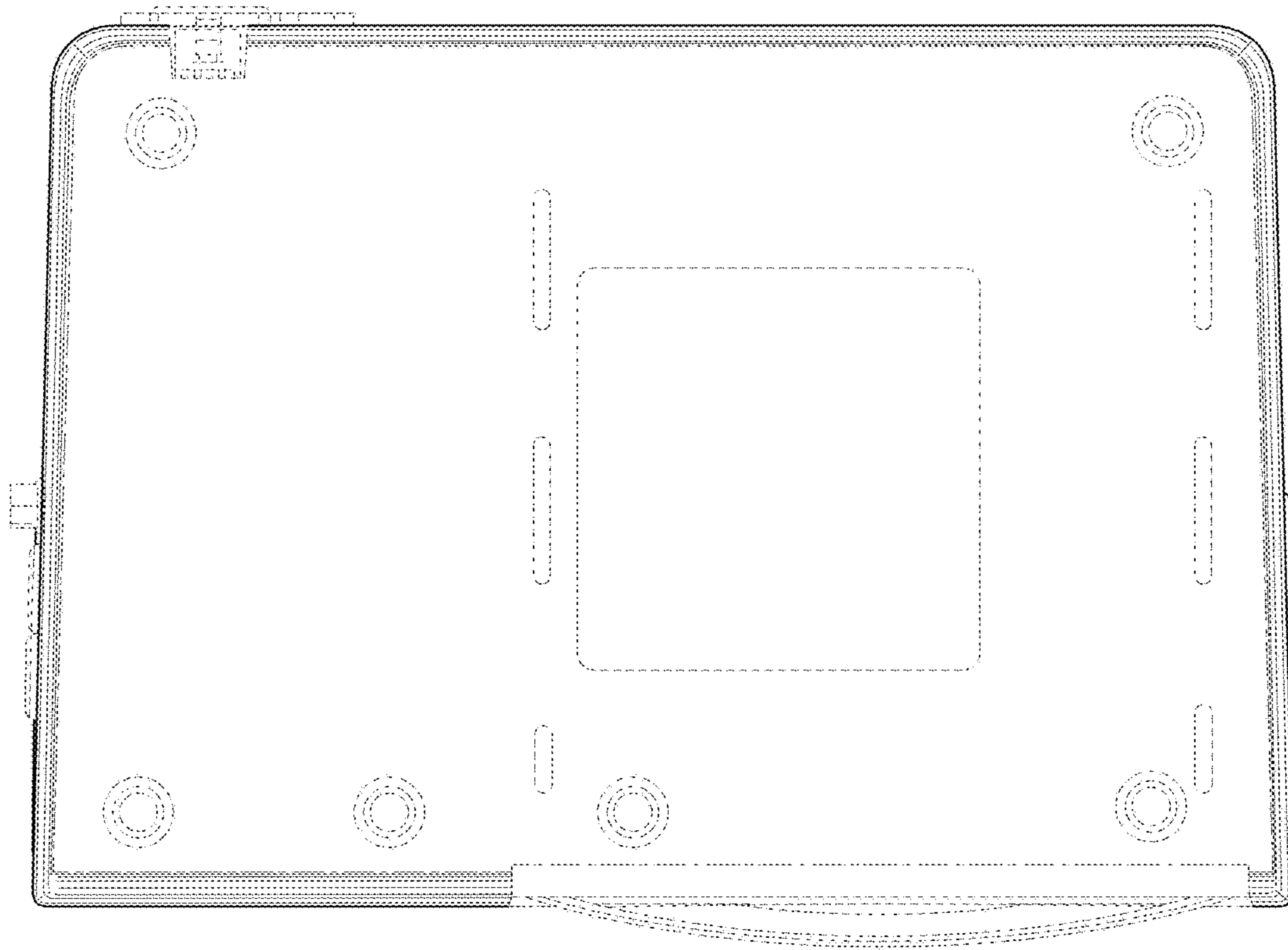

FIG. 9