



US00D821932S

(12) **United States Design Patent** (10) **Patent No.:** **US D821,932 S**
Andoh (45) **Date of Patent:** **** Jul. 3, 2018**

(54) **FRONT GRILLE FOR AN AUTOMOBILE**

(71) Applicant: **Fuji Jukogyo Kabushiki Kaisha,**
Tokyo (JP)

(72) Inventor: **Takahiro Andoh,** Tokyo (JP)

(73) Assignee: **Subaru Corporation,** Tokyo (JP)

(**) Term: **15 Years**

(21) Appl. No.: **29/572,995**

(22) Filed: **Aug. 2, 2016**

(30) **Foreign Application Priority Data**

Feb. 2, 2016 (JP) 2016-002141

(51) **LOC (11) Cl.** **12-16**

(52) **U.S. Cl.**
USPC **D12/163**

(58) **Field of Classification Search**

USPC D12/86, 91, 93, 163, 164, 166, 167, 169,
D12/171, 172, 173, 190, 216

CPC B62D 25/08; B62B 9/16; B60R 19/52;
B60R 19/12; B60R 19/38; B60R 19/023;
B60R 13/00; B60R 13/005; B60R 13/04;
B60K 11/04; B60K 11/08; B60K 11/085;
B60Q 1/50; B60Q 1/2661; B60Q 1/38

See application file for complete search history.

(56) **References Cited**

U.S. PATENT DOCUMENTS

D496,890 S * 10/2004 Metros D12/163
D668,590 S * 10/2012 Furst D12/163

D687,751 S * 8/2013 Futschik D12/163
D701,798 S * 4/2014 Futschik D12/164
D759,551 S * 6/2016 Nakahara D12/163
D769,160 S * 10/2016 Platto D12/163
D783,465 S * 4/2017 Choi D12/163
D789,841 S * 6/2017 Malczewski D12/163
D790,412 S * 6/2017 Dunford D12/163
D790,413 S * 6/2017 Doyle D12/164
D793,918 S * 8/2017 Kozub D12/163
D794,517 S * 8/2017 Woolley D12/163
2017/0137954 A1* 5/2017 Hashimoto B60K 11/08

* cited by examiner

Primary Examiner — Susan Bennett Hattan

Assistant Examiner — Suzanne E Tisdell

(74) *Attorney, Agent, or Firm* — Schiff Hardin LLP

(57) **CLAIM**

The ornamental design for a front grille for an automobile thereof, as shown and described.

DESCRIPTION

FIG. 1 is a front perspective view for a “front grille for an automobile” showing my new design, FIG. 2 is a rear perspective view thereof, FIG. 3 is a front view thereof, FIG. 4 is a rear view thereof, FIG. 5 is a top view thereof, FIG. 6 is a bottom view thereof, FIG. 7 is a left-side view thereof; and, FIG. 8 is a right-side view thereof.

1 Claim, 8 Drawing Sheets

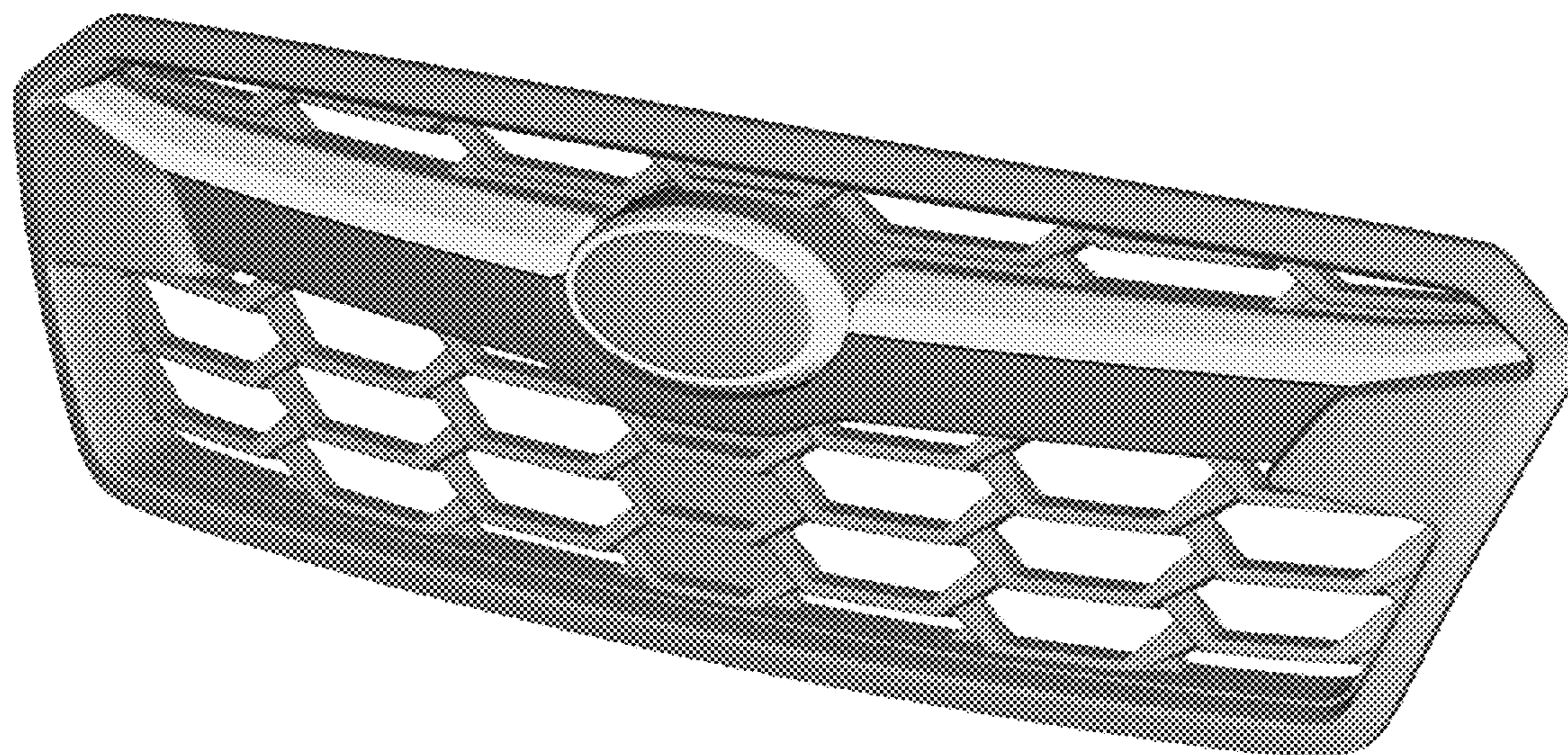

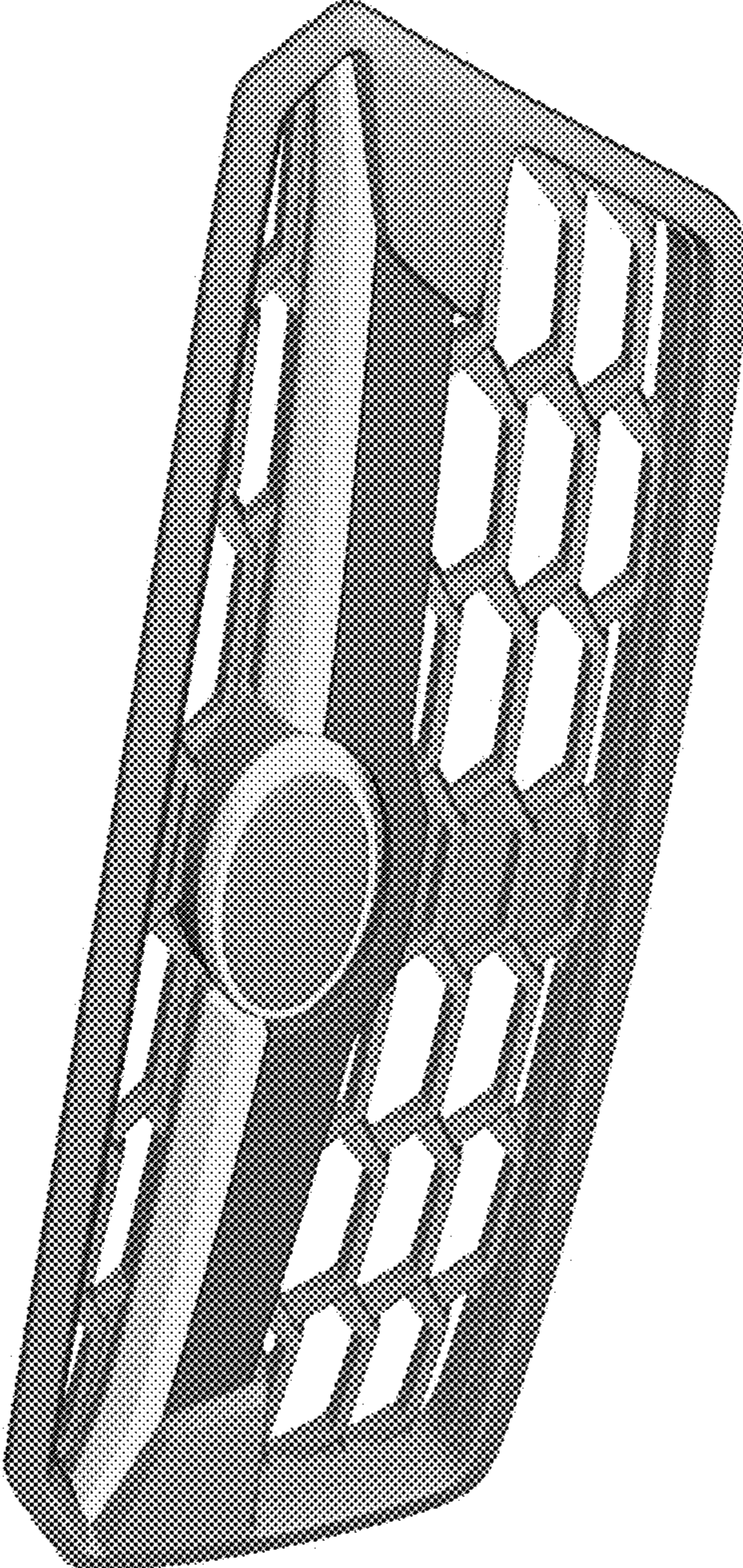

FIG. 1

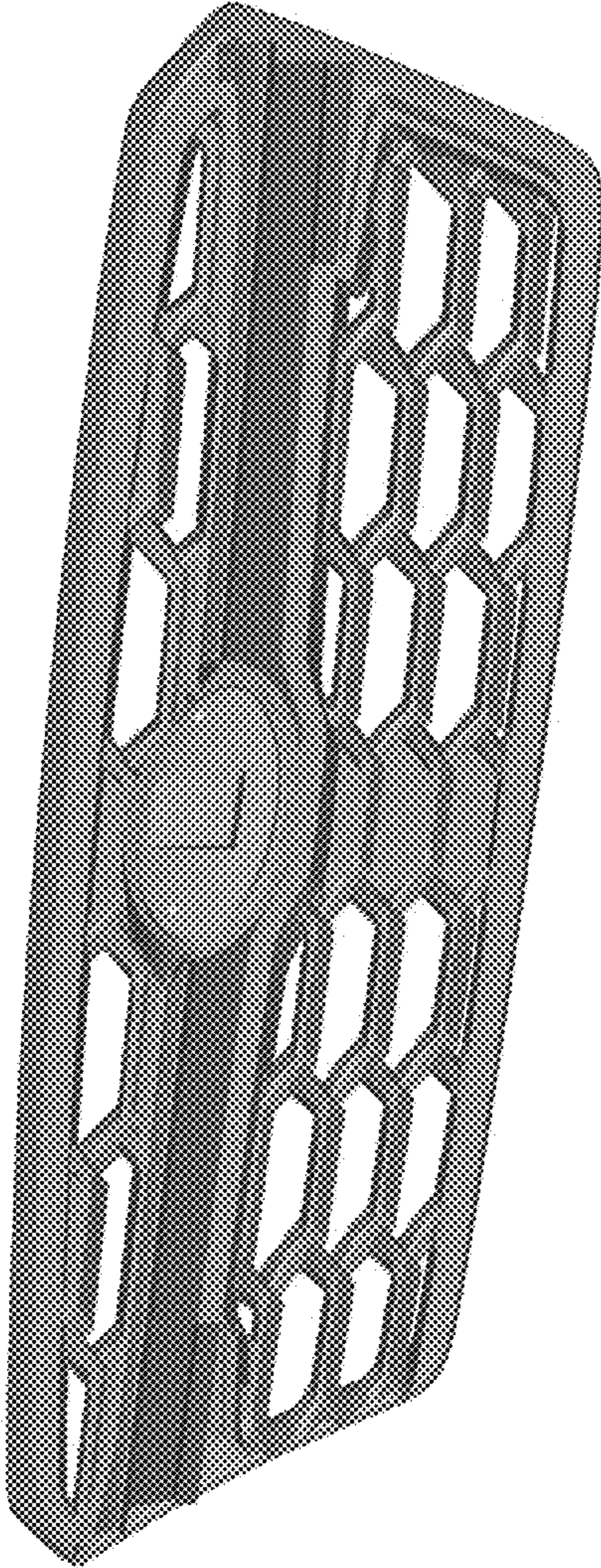

FIG. 2

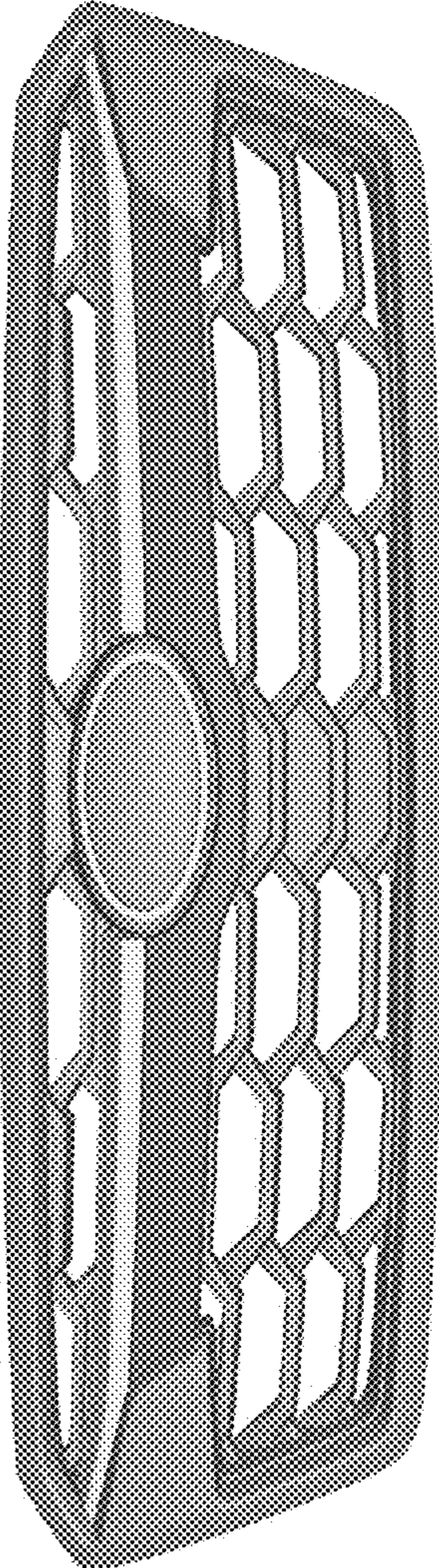

FIG. 3

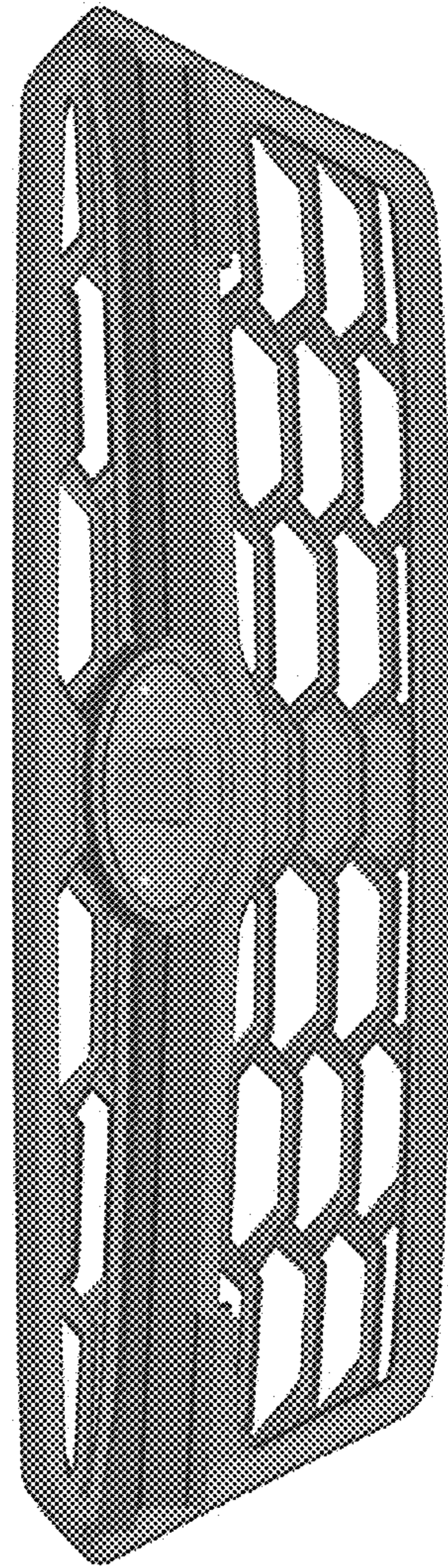

FIG. 4

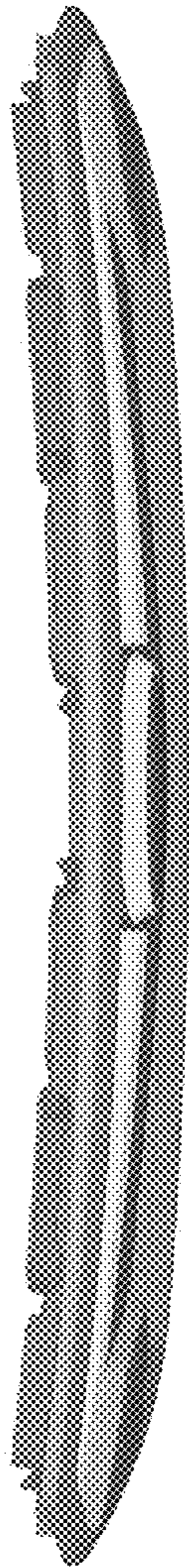

FIG. 5

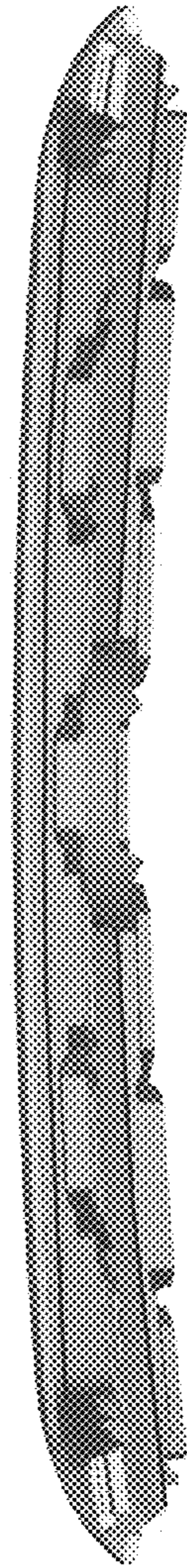

FIG. 6

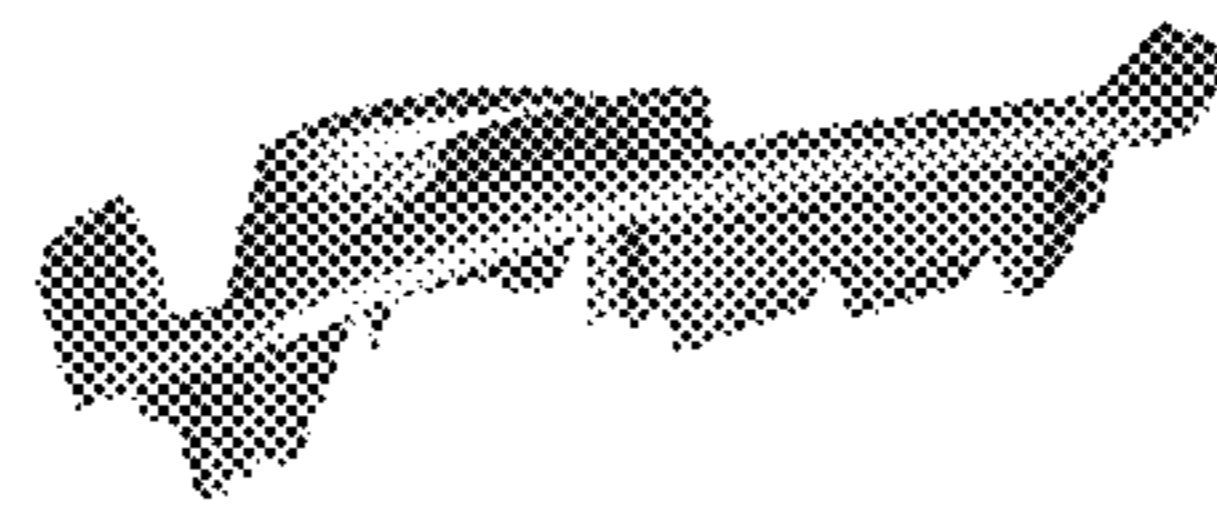

FIG. 7

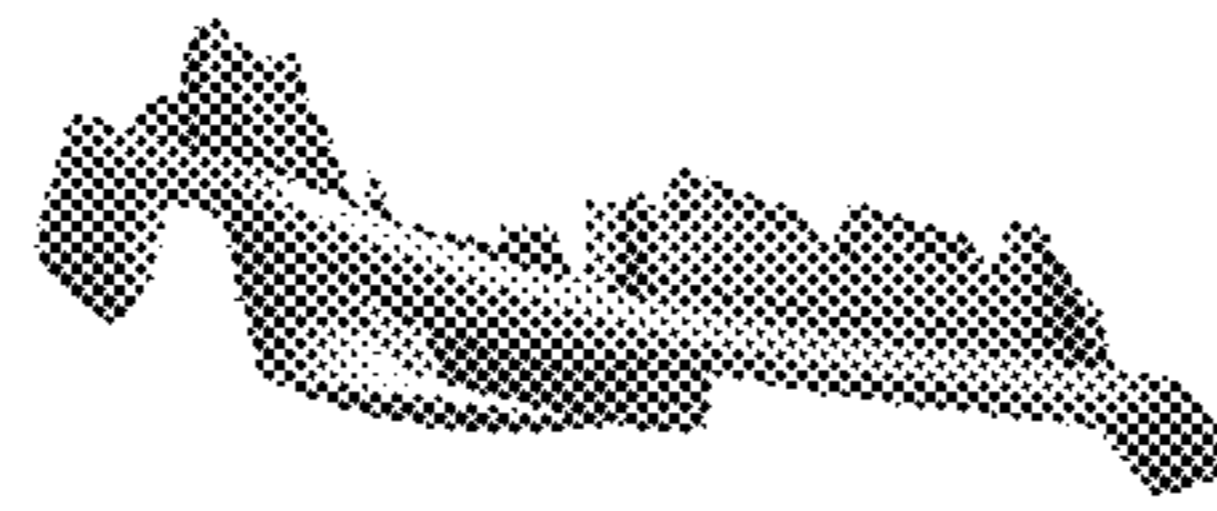

FIG. 8