

US00D821827S

(12) **United States Design Patent** (10) **Patent No.:** **US D821,827 S**  
**O'Halloran et al.** (45) **Date of Patent:** **\*\* Jul. 3, 2018**

(54) **HANDHELD GRATER**  
 (71) Applicants: **Jeremy O'Halloran**, Brentwood, PA  
 (US); **Tom Chavara**, Providence, RI  
 (US); **Marvin Church**, Apollo, PA (US)

(72) Inventors: **Jeremy O'Halloran**, Brentwood, PA  
 (US); **Tom Chavara**, Providence, RI  
 (US); **Marvin Church**, Apollo, PA (US)

(73) Assignee: **HELEN OF TROY LIMITED**, St.  
 Michael (BB)

(\*\*) Term: **15 Years**

(21) Appl. No.: **29/616,888**

(22) Filed: **Sep. 10, 2017**

(51) **LOC (11) Cl.** ..... **07-04**

(52) **U.S. Cl.**  
 USPC ..... **D7/678**

(58) **Field of Classification Search**  
 USPC ..... D7/678, 680-696, 393, 395, 669, 368;  
 D28/59

CPC .. A47J 19/04; A47J 17/02; A47J 17/04; A47J  
 43/00; A47J 43/25; A47J 43/255; B26D  
 1/30; B26D 7/18

See application file for complete search history.

(56) **References Cited**

U.S. PATENT DOCUMENTS

6,318,652 B1 \* 11/2001 Liu ..... A47J 43/25  
 241/168  
 6,860,441 B2 \* 3/2005 Richardson ..... A47J 43/25  
 241/168

D604,124 S \* 11/2009 Smith ..... D7/678  
 D666,064 S \* 8/2012 Smith ..... D10/46.2  
 D680,820 S \* 4/2013 McGuyer ..... D7/678  
 D695,579 S \* 12/2013 Kestenbaum ..... D7/678  
 D699,523 S \* 2/2014 McGuyer ..... D7/678  
 D741,017 S \* 10/2015 Exley ..... D28/59  
 D757,503 S \* 5/2016 Schuler ..... D7/678  
 D798,676 S \* 10/2017 McGuyer ..... D7/678  
 D799,283 S \* 10/2017 McGuyer ..... D7/678  
 2003/0035693 A1 \* 2/2003 Chalfant ..... A47J 43/25  
 407/29.1  
 2004/0247403 A1 \* 12/2004 Grace ..... A47J 43/25  
 407/29.15  
 2010/0012758 A1 \* 1/2010 Chalfant ..... A47J 43/25  
 241/95

\* cited by examiner

*Primary Examiner* — Terry A Wallace

(57) **CLAIM**

The ornamental design for a handheld grater, as shown, and described.

**DESCRIPTION**

FIG. 1 is a perspective view of the handheld grater;  
 FIG. 2 is a front elevation view thereof;  
 FIG. 3 is a rear elevation view thereof;  
 FIG. 4 is a right side view thereof (with the left side a mirror  
 image thereof);  
 FIG. 5 is a top view thereof; and,  
 FIG. 6 is a bottom view thereof.  
 The broken lines represent grater slits, which form no part  
 of the claimed design.

**1 Claim, 6 Drawing Sheets**

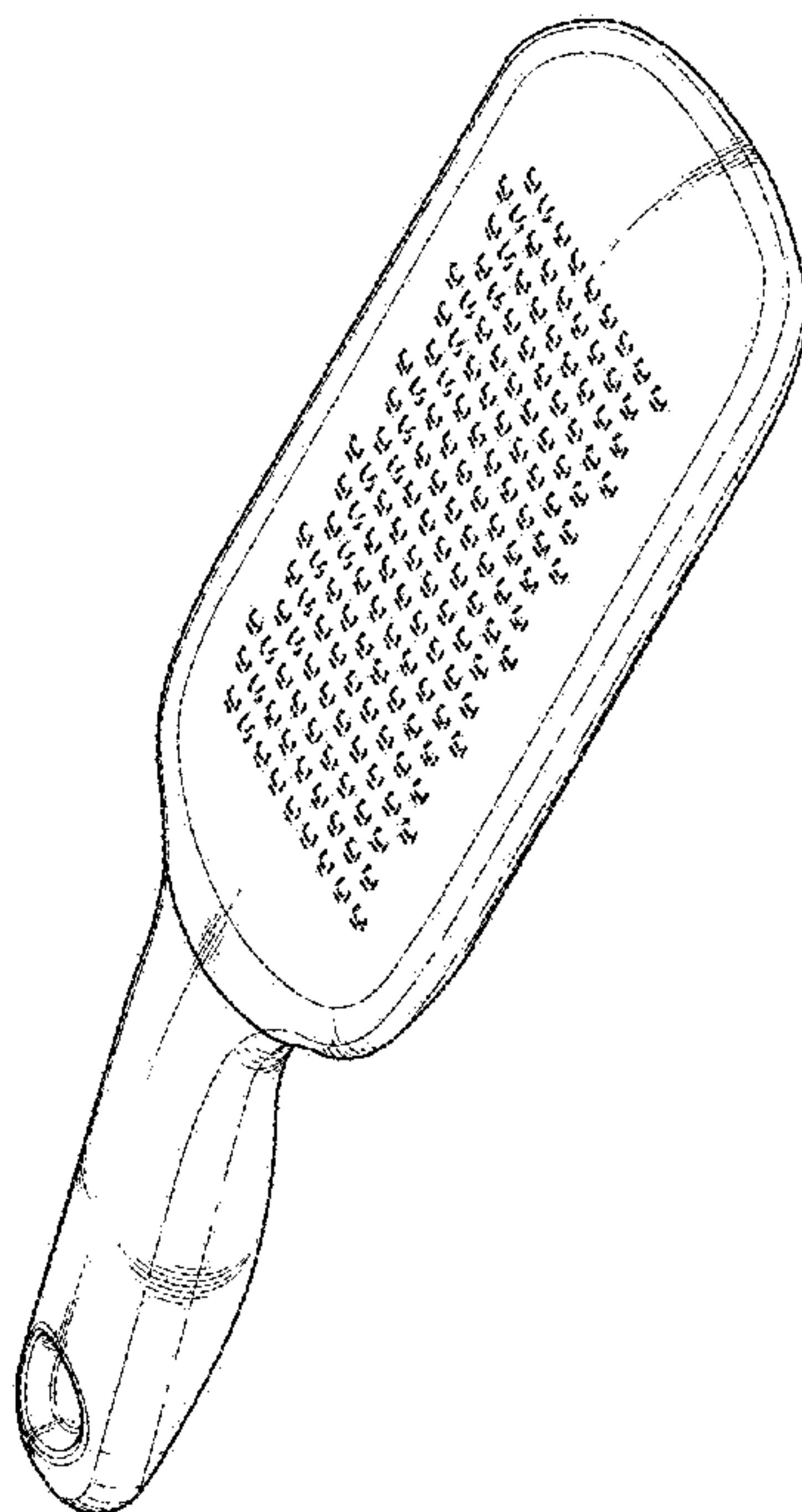

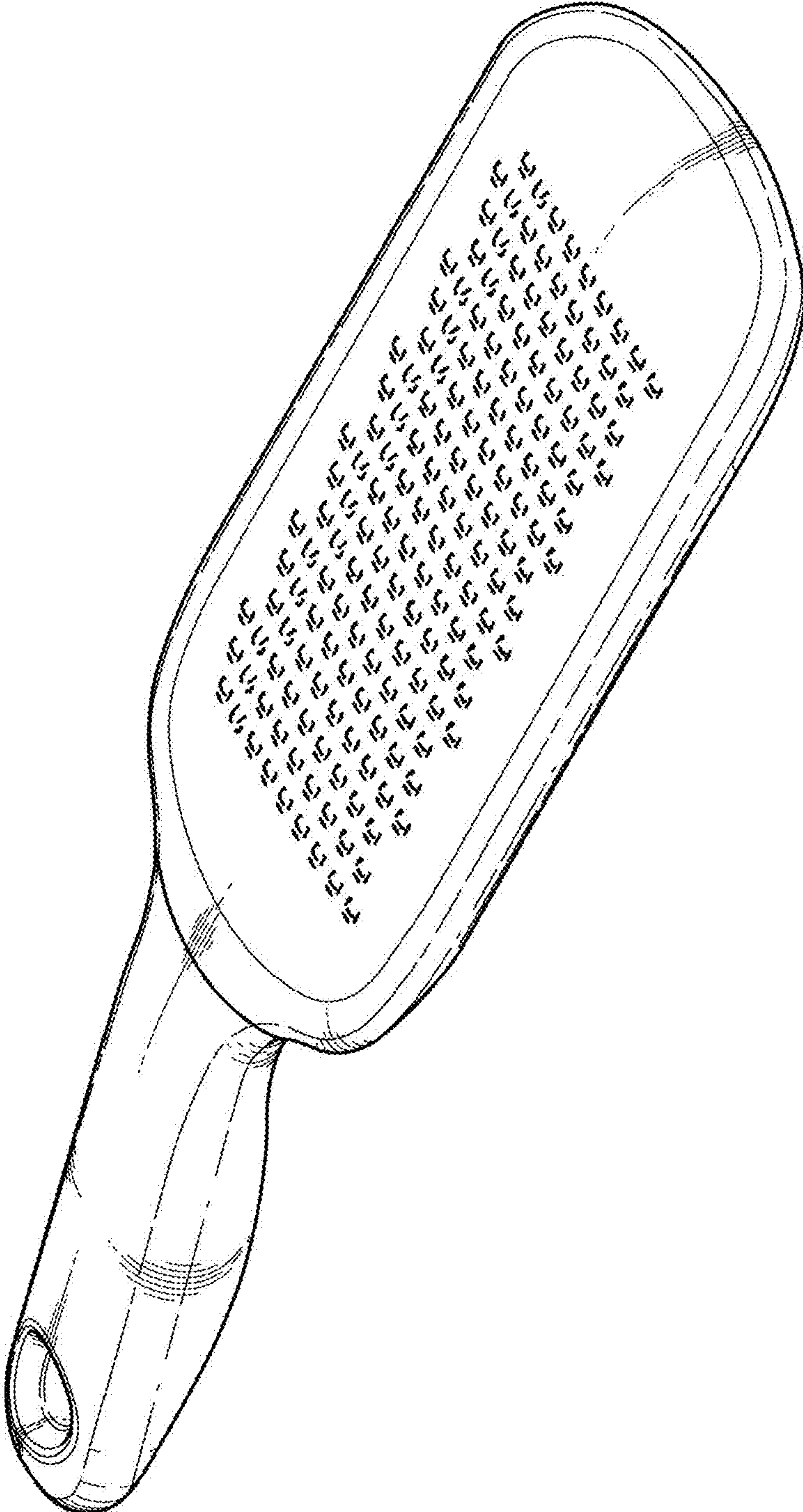

FIG. 1

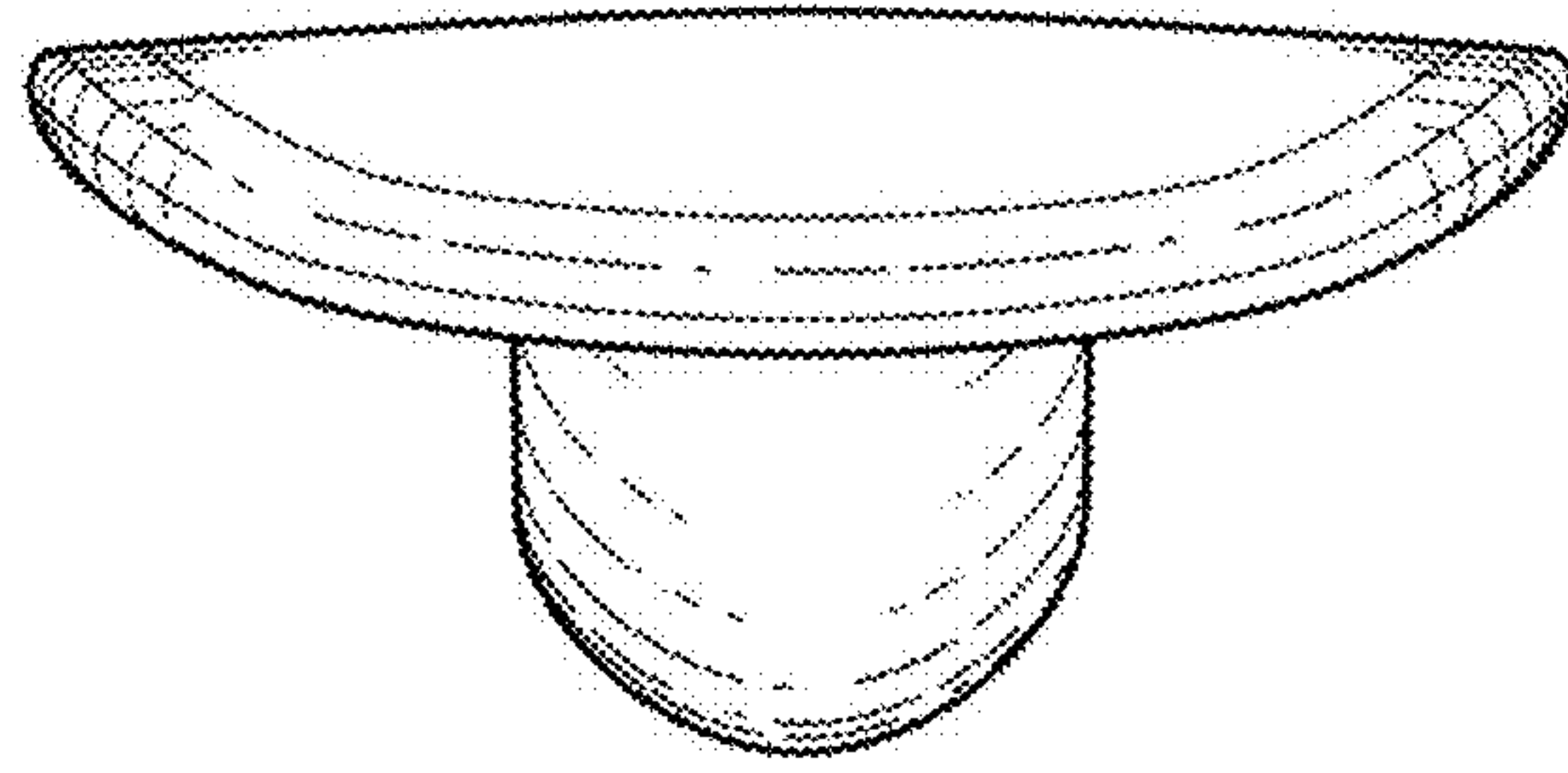

FIG. 2

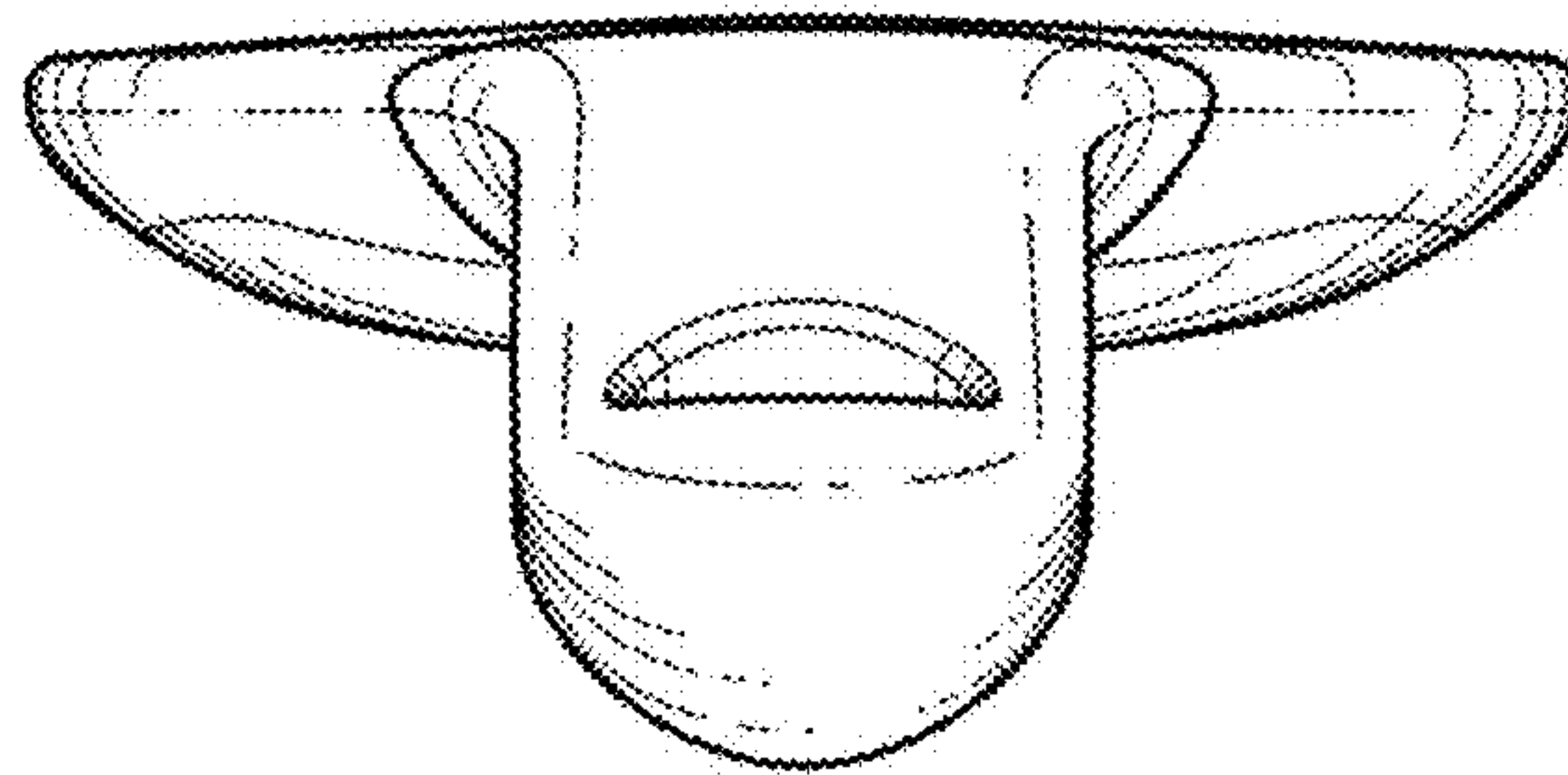

FIG. 3

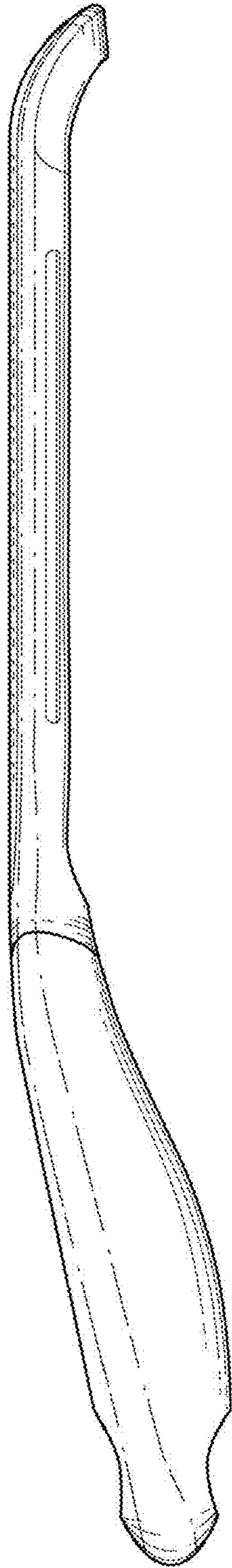

FIG. 4



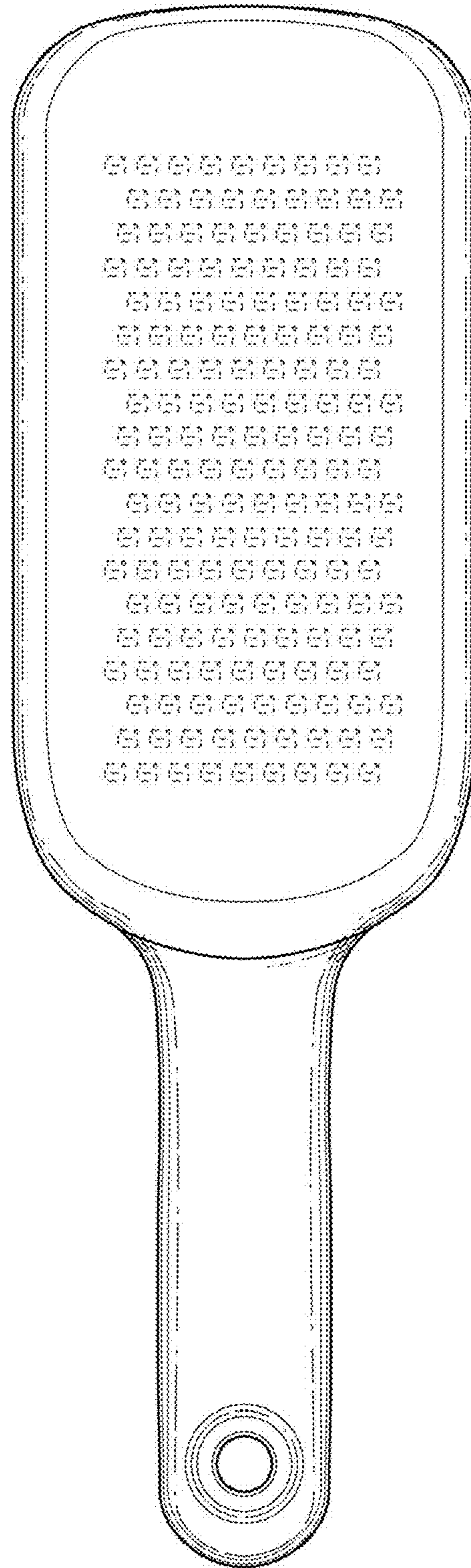

FIG. 5

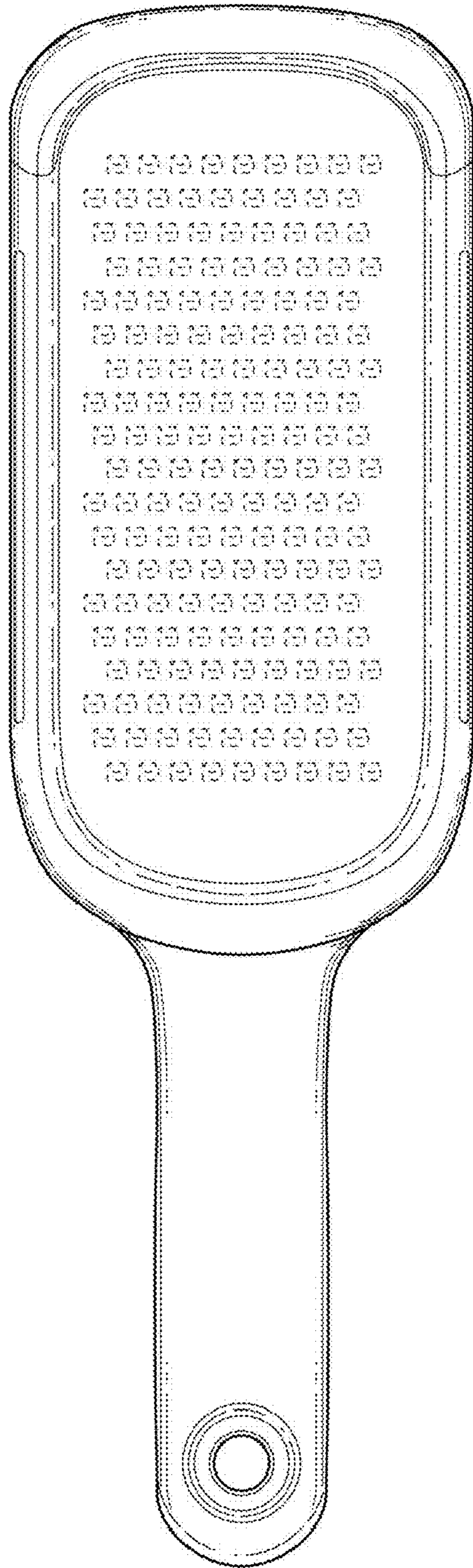

FIG. 6