



US00D821805S

(12) **United States Design Patent** (10) **Patent No.:** **US D821,805 S**
Lee (45) **Date of Patent:** **** Jul. 3, 2018**

(54) **COOKING PAN**

(71) Applicant: **Jin Hee Lee**, Seoul (KR)

(72) Inventor: **Jin Hee Lee**, Seoul (KR)

(**) Term: **15 Years**

(21) Appl. No.: **29/564,938**

(22) Filed: **May 17, 2016**

(30) **Foreign Application Priority Data**

Nov. 19, 2015 (KR) 30-2015-0058269

(51) **LOC (11) Cl.** **07-02**

(52) **U.S. Cl.**
USPC **D7/359**

(58) **Field of Classification Search**

USPC D3/201, 202, 203.1, 270, 271.1, 304,
D3/315, 319; D7/323, 331, 353, 354,
D7/356, 357, 359, 390, 402, 409, 550.1,
D7/552.1, 553.1, 553.2, 553.7, 554.1,
D7/554.3, 554.4, 601; D6/553, 567, 570,
D6/571, 675, 677, 681, 683.1; D9/414,
D9/428, 430, 432, 436, 755, 759;
D12/163, 197, 415, 425; D21/524, 525,
D21/532; D23/260, 261, 268, 397;
D26/28; D28/61; D30/129, 130, 132,
D30/133

CPC A47G 19/12; A47J 27/00; A47J 27/002;
A47J 27/004; A47J 27/08; A47J 27/21;
A47J 27/58; A47J 35/025; A47J 45/061;
A47J 45/065; A47J 45/071; A47J 45/08;
A47J 29/00; A47J 29/02; A47J 29/04;
A47J 29/06; A47J 36/025; A45J 37/00;
A45J 37/10; A45J 37/101; A45J 37/103;
A45J 37/1204; A45J 37/0704; H05B
6/06; H05B 6/12; A01K 41/02; A01K
41/026; A01K 41/04; A23B 5/00; A23B
5/005; A23B 5/0052; B65D 11/02

See application file for complete search history.

(56) **References Cited**

U.S. PATENT DOCUMENTS

D2,549 S * 1/1867 Musselman's D7/359
D75,432 S * 6/1928 Keller, Jr. 131/231
1,936,551 A * 11/1933 Garrison A47J 37/10
99/339
D277,254 S * 1/1985 Matsuhisa D7/359
D373,285 S * 9/1996 Coroama D7/359
D376,723 S * 12/1996 Asner D7/359

(Continued)

Primary Examiner — Thomas Johannes

Assistant Examiner — Catherine S Posthauer

(74) *Attorney, Agent, or Firm* — Kile Park Reed & Houtteman PLLC

(57) **CLAIM**

I claim, the ornamental design for a cooking pan, as shown and described.

DESCRIPTION

FIG. 1 is a top and front perspective view of a cooking pan, showing my new design;
FIG. 2 is a front view thereof;
FIG. 3 is a rear view thereof;
FIG. 4 is a left side view thereof;
FIG. 5 is a right side view thereof;
FIG. 6 is a top plan view thereof;
FIG. 7 is a bottom plan view thereof; and,
FIG. 8 is an enlarged detail view of an oval aperture, taken from reference "8" on FIG. 1, and rotated slightly for clarity of details.

The shorter broken lines are shown for the purpose of illustrating parts of the article that form no part of the claim. The longer dashed broken lines are shown for the purpose of designating the enlargement view of FIG. 8 and its origin reference on FIG. 1 and form no part of the claim.

1 Claim, 6 Drawing Sheets

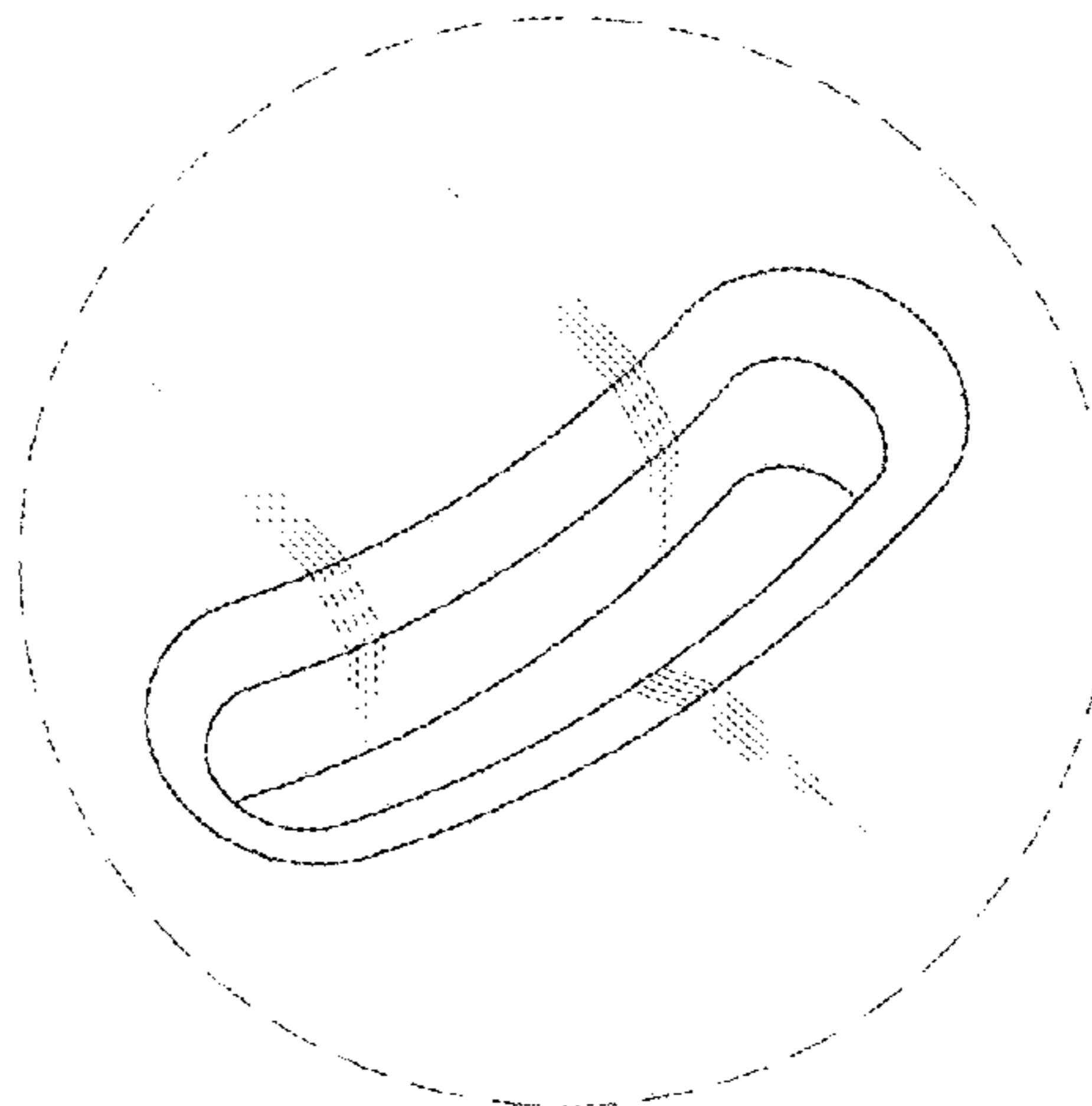
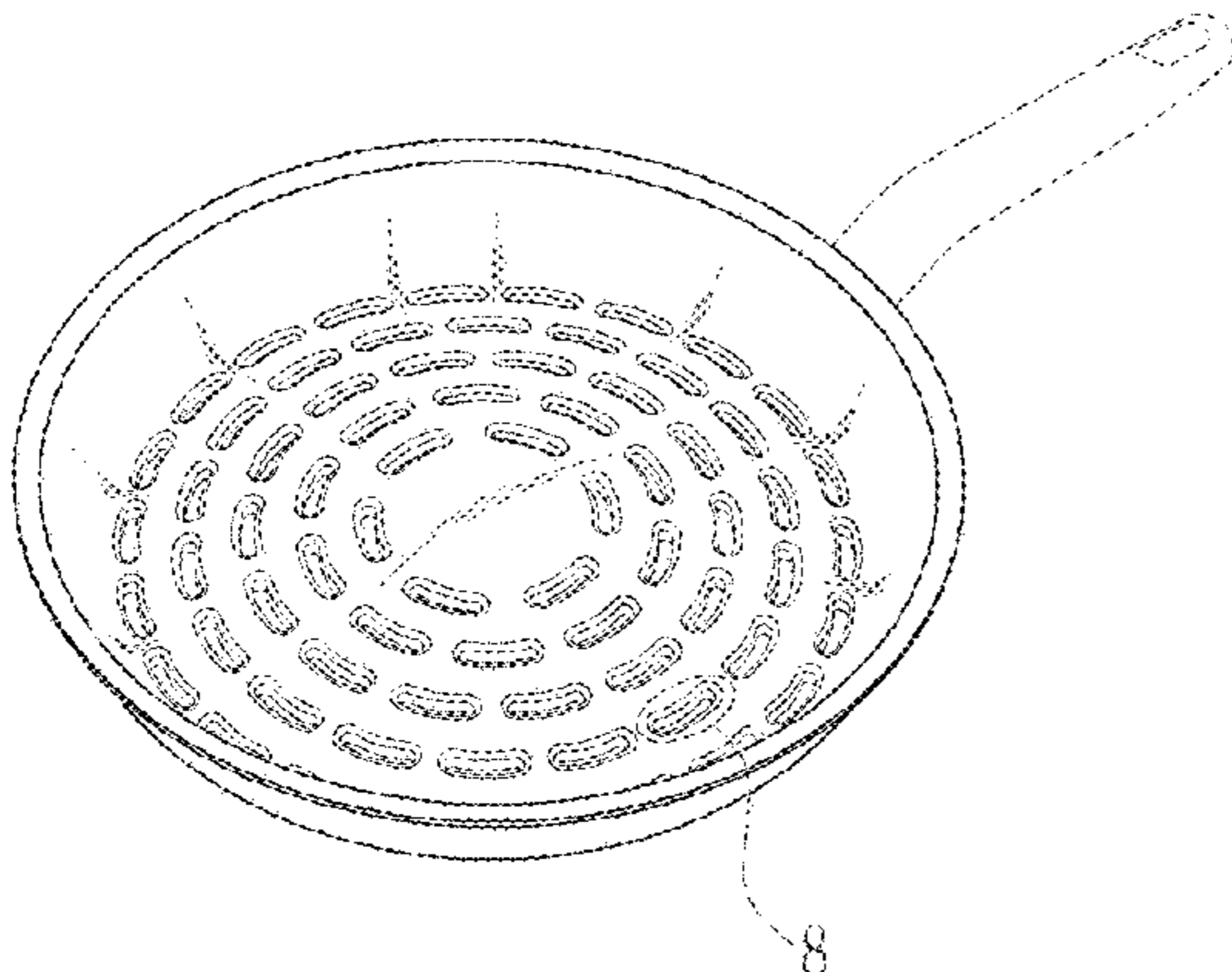

(56)

References Cited

U.S. PATENT DOCUMENTS

5,628,426 A * 5/1997 Doyle A47J 27/022
220/608
D414,981 S * 10/1999 Roskind D7/359
6,054,697 A * 4/2000 Woodward A21B 3/13
219/680
D431,151 S * 9/2000 Brunianyn D7/354
6,523,460 B1 * 2/2003 Lange A47J 37/108
99/340
D573,466 S * 7/2008 White D9/456
D639,604 S * 6/2011 Degnan D7/354
D669,730 S * 10/2012 Mandil D7/354
D676,705 S * 2/2013 Di Bartolo D7/354
D682,012 S * 5/2013 Lin D7/354
D689,326 S * 9/2013 Ortegon D7/354
D731,231 S * 6/2015 Steininger D7/354
D735,520 S * 8/2015 Mandil D7/354
D737,103 S * 8/2015 Cloutier D7/554.2
D742,698 S * 11/2015 Kellow, Jr. D7/553.8
D766,646 S * 9/2016 Navare D7/354
D774,350 S * 12/2016 Mandil D7/354
D779,871 S * 2/2017 Zemel D7/354
D784,076 S * 4/2017 Constantieux D7/402
2012/0055346 A1 * 3/2012 Navare A47J 37/10
99/445
2012/0248123 A1 * 10/2012 Rayudu A47J 27/002
220/573.1
2012/0305568 A1 * 12/2012 Lee A47J 36/025
220/573.2
2012/0312822 A1 * 12/2012 Cheng A47J 45/068
220/573.1
2015/0053696 A1 * 2/2015 Borovicka A47J 45/071
220/573.1
2016/0058229 A1 * 3/2016 Livesey A47J 45/061
220/573.1

* cited by examiner

FIG. 1

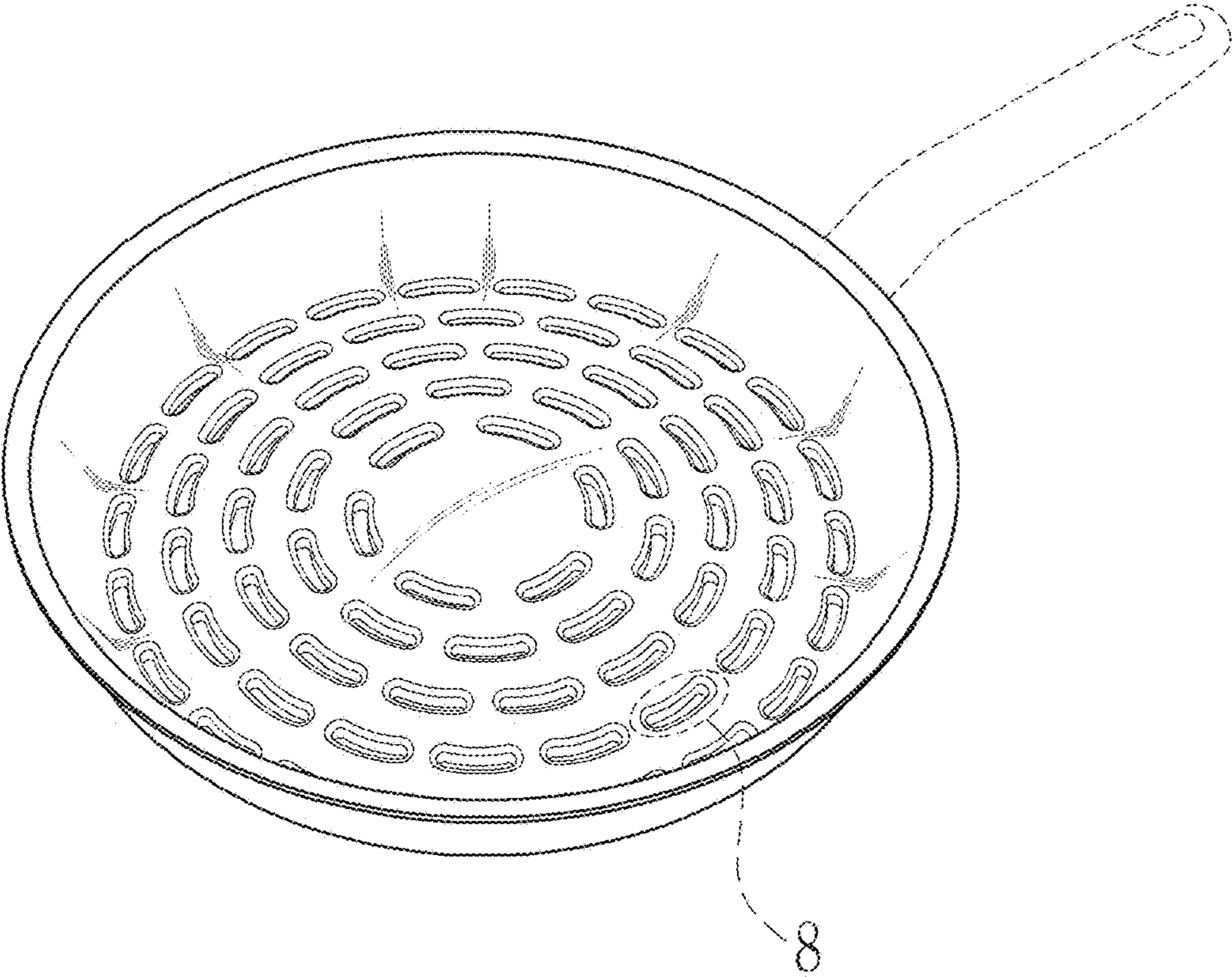

FIG. 2

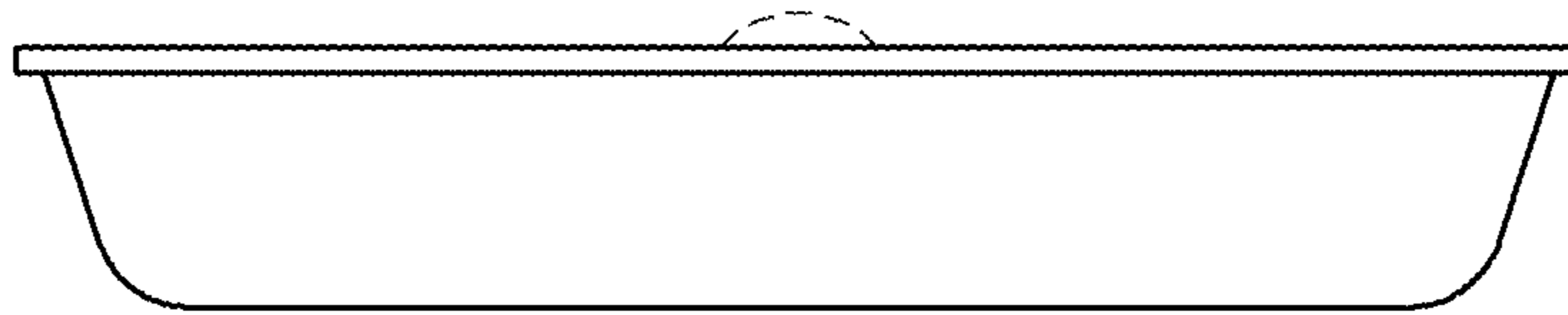

FIG. 3

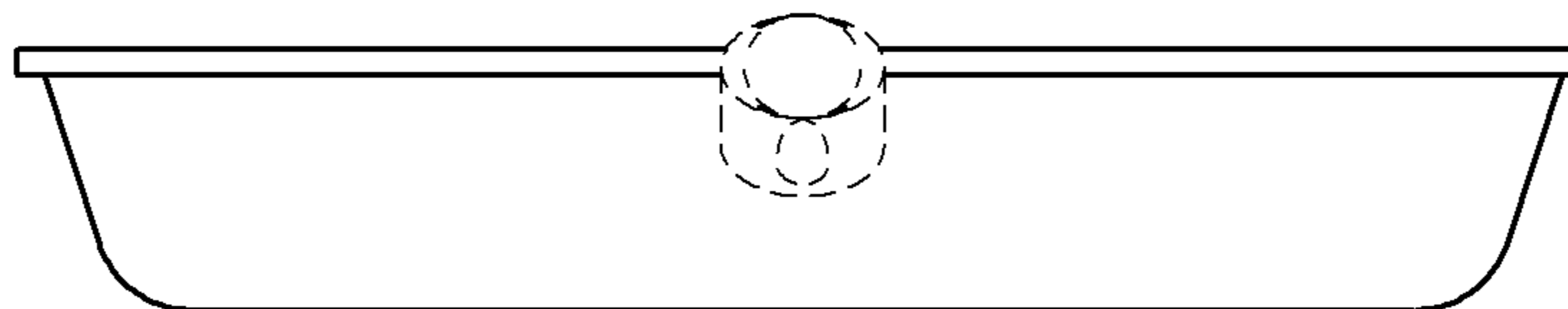

FIG. 4



FIG. 5

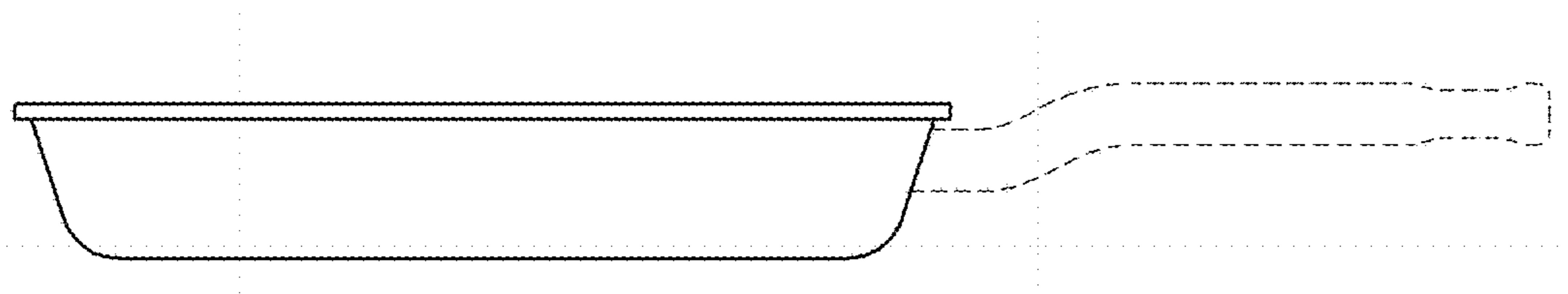

FIG. 6

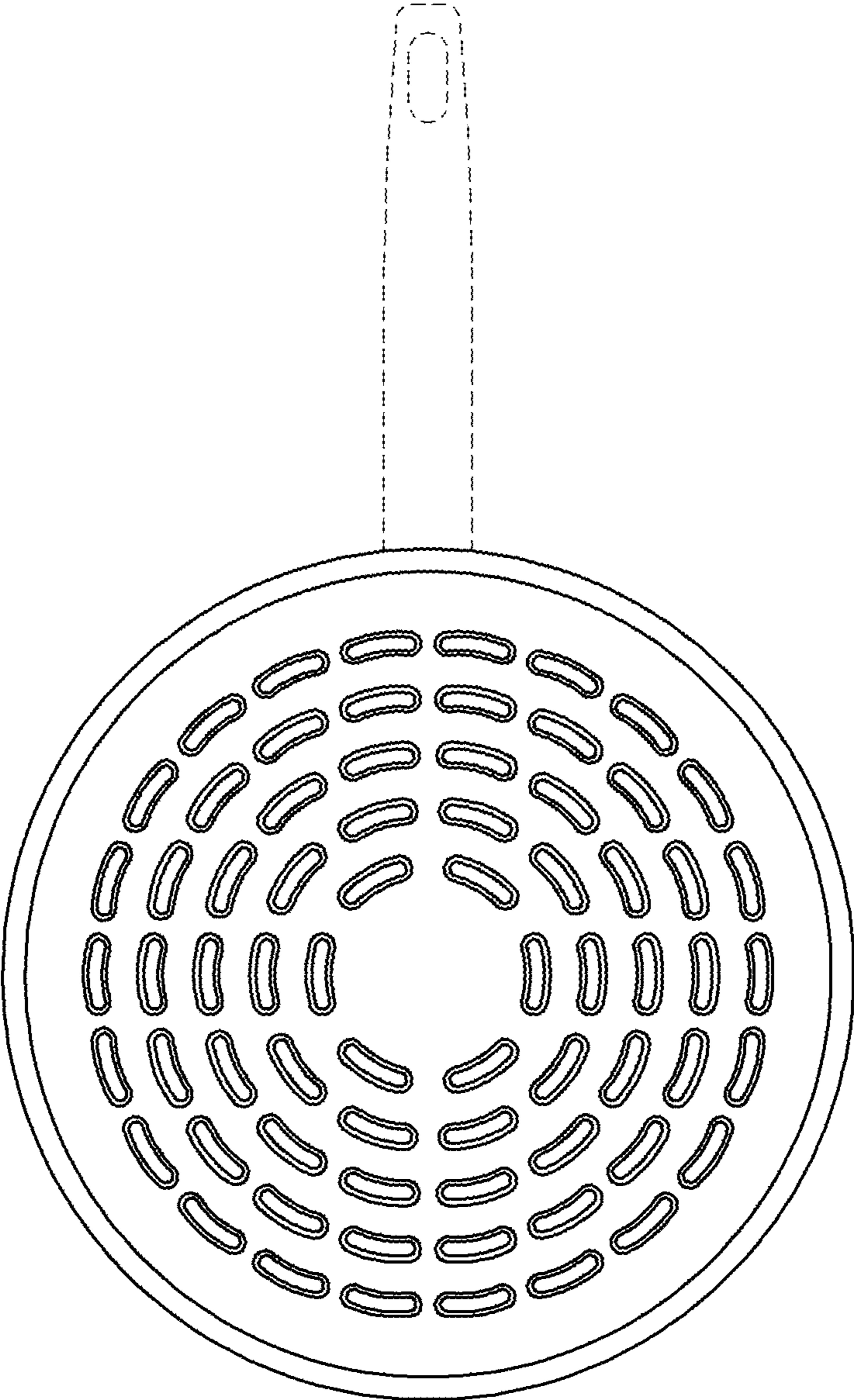

FIG. 7

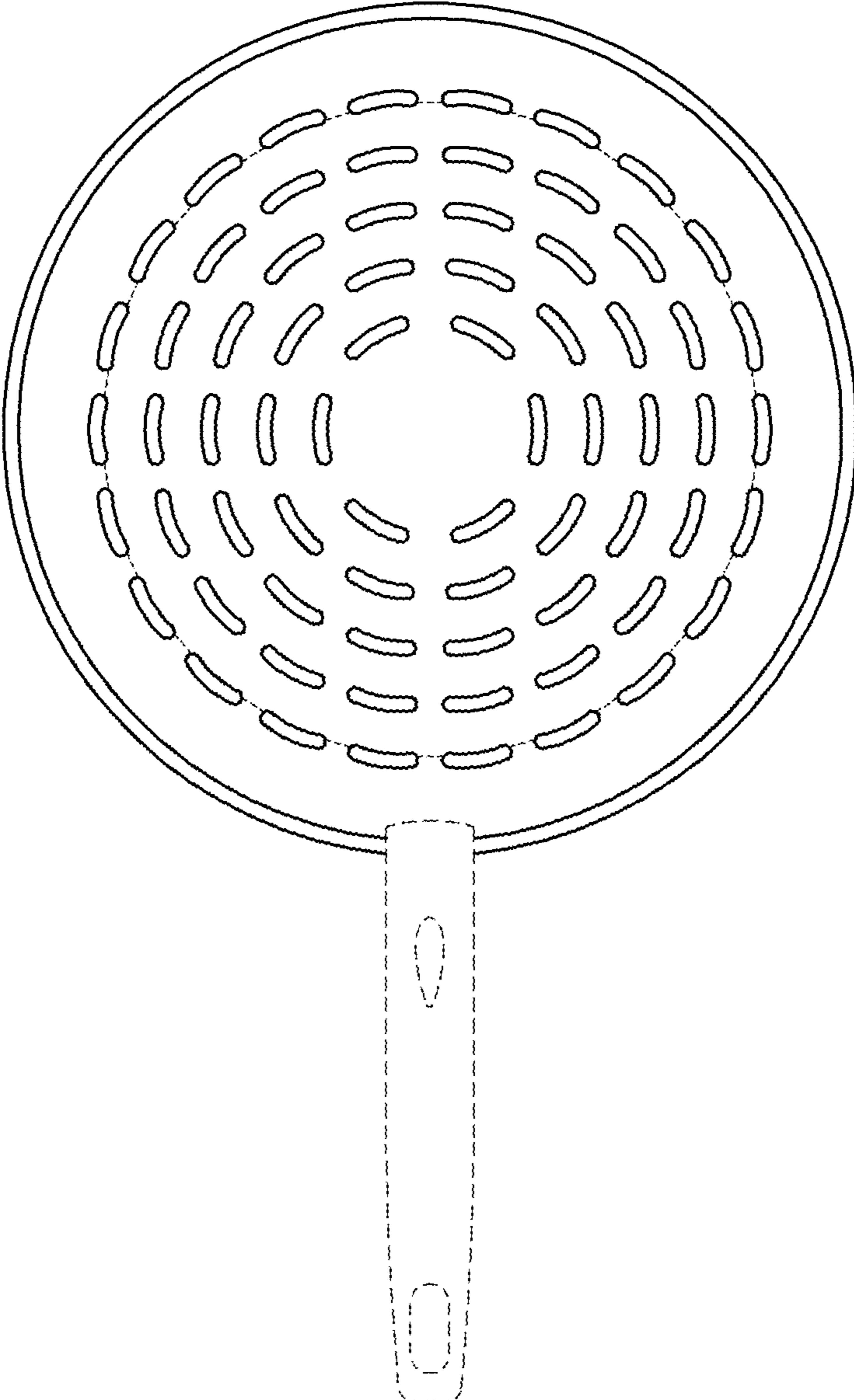

FIG. 8

