



US00D821777S

(12) **United States Design Patent**
Hale

(10) **Patent No.:** **US D821,777 S**
(45) **Date of Patent:** **** Jul. 3, 2018**

(54) **CHAIR**

(71) Applicant: **Williams-Sonoma, Inc.**, San Francisco, CA (US)

(72) Inventor: **Edward Hale**, Brooklyn, NY (US)

(73) Assignee: **Williams-Sonoma, Inc.**, San Francisco, CA (US)

(**) Term: **15 Years**

(21) Appl. No.: **29/616,824**

(22) Filed: **Sep. 8, 2017**

(51) **LOC (11) Cl.** **06-01**

(52) **U.S. Cl.**
USPC **D6/380; D6/375**

(58) **Field of Classification Search**
USPC D6/334-336, 371, 372, 373, 374, 375, D6/380, 716, 716.1, 716.2, 716.3, 716.4
CPC A47C 3/04; A47C 3/12; A47C 4/02; A47C 4/028; A47C 4/03; A47C 5/06; A47C 5/12; A47C 7/021; A47C 7/18; A47C 7/24

See application file for complete search history.

(56) **References Cited**

U.S. PATENT DOCUMENTS

D173,389 S * 11/1954 Sherman D6/375
2,723,712 A * 11/1955 Yellen A47C 3/12
297/440.11

D180,138 S * 4/1957 Futorian D6/375
D183,743 S * 10/1958 Howell, Jr. D6/375
D191,704 S * 11/1961 Stauffer D6/375
3,656,808 A * 4/1972 Chang A47C 5/06
297/285
D815,452 S * 4/2018 Hannoosh D6/380

* cited by examiner

Primary Examiner — Mimosa De

(74) *Attorney, Agent, or Firm* — Cook Alex Ltd.; R. Blake Johnston

(57) **CLAIM**

The ornamental design for a chair, as shown and described.

DESCRIPTION

FIG. 1 is a perspective view of the chair;
FIG. 2 is a front elevational view of the chair;
FIG. 3 is a rear elevational view of the chair;
FIG. 4 is a left side elevational view of the chair;
FIG. 5 is a right side elevational view of the chair;
FIG. 6 is a top plan view of the chair; and,
FIG. 7 is a bottom plan view of the chair.

1 Claim, 4 Drawing Sheets

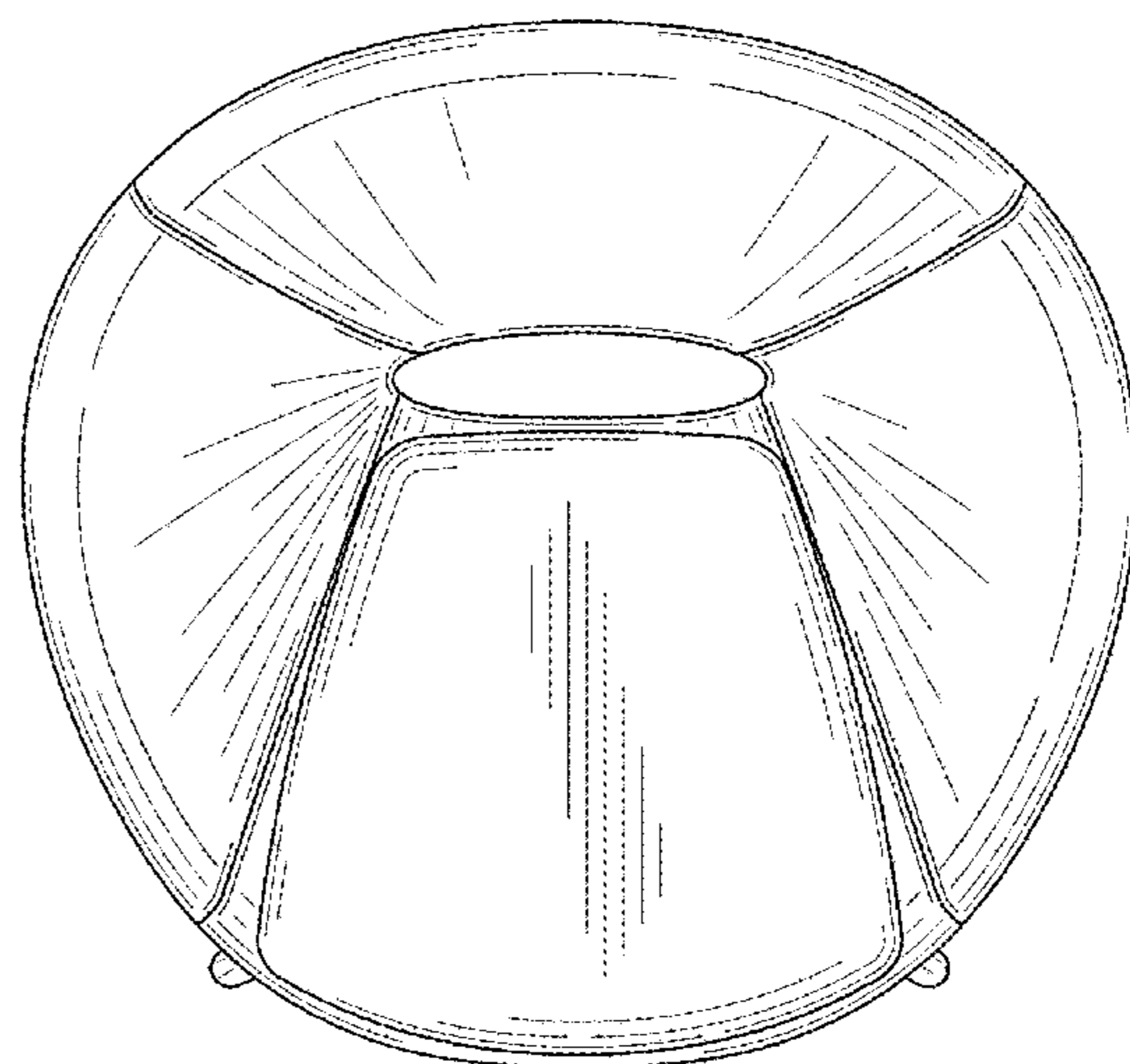
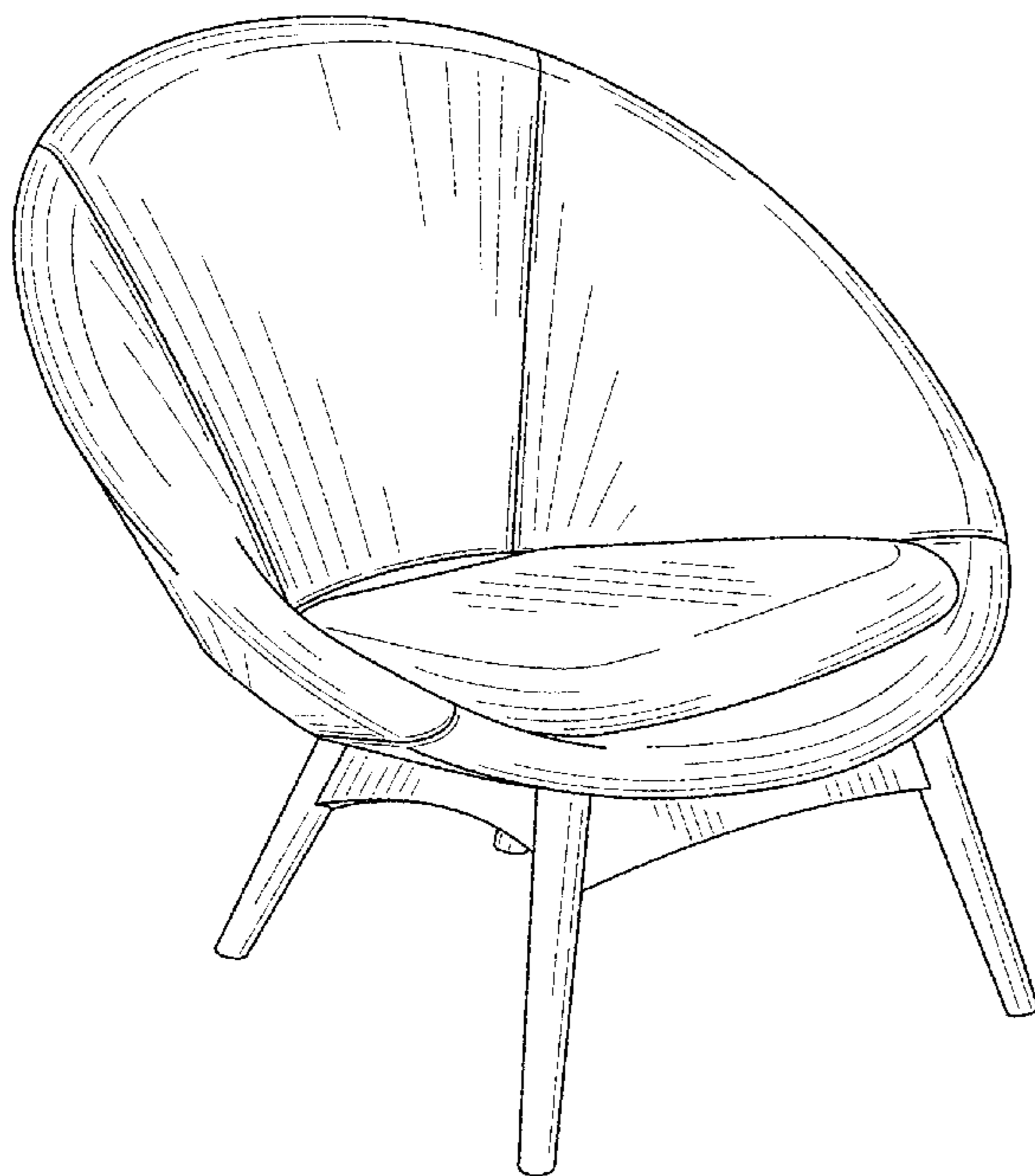

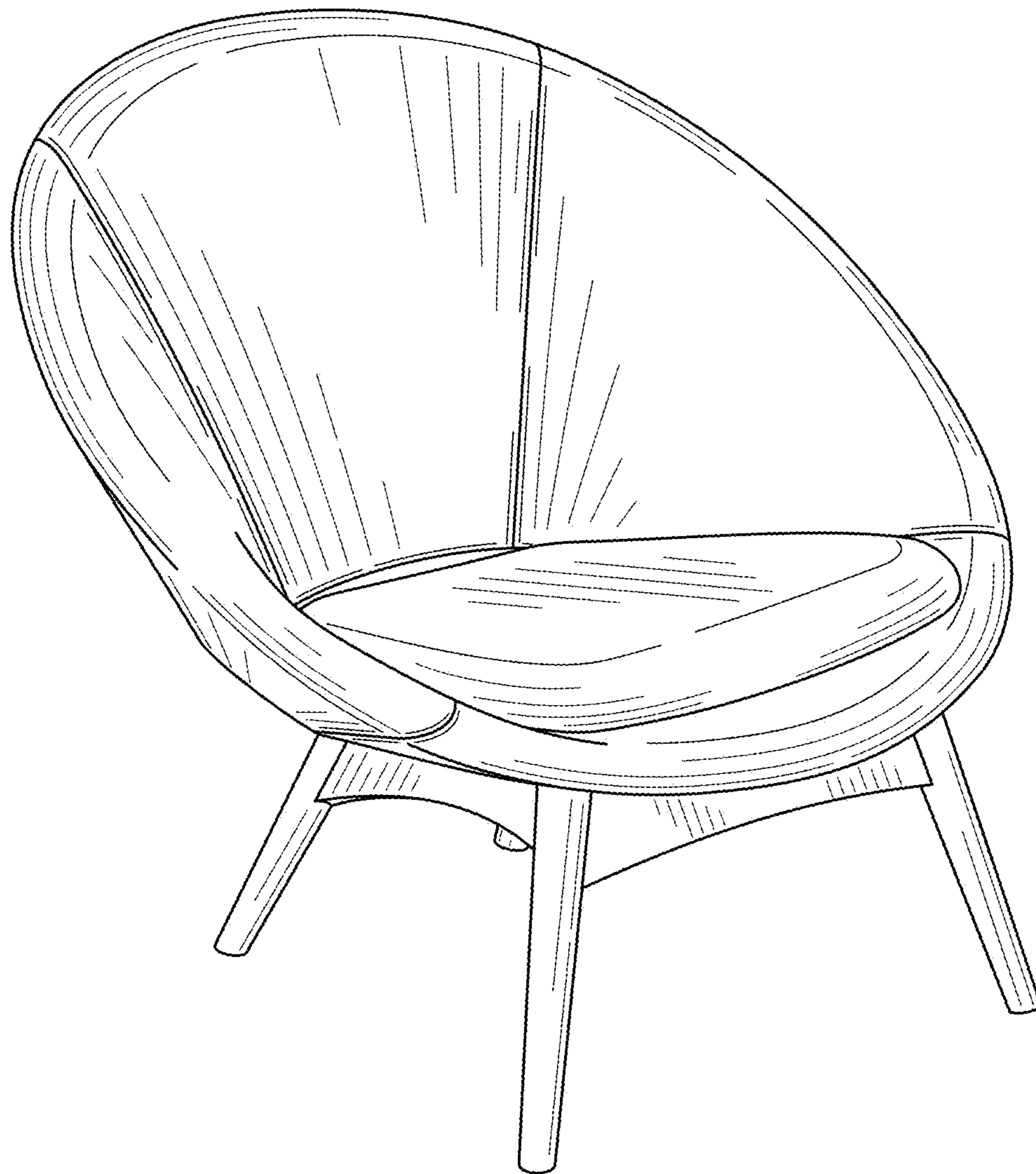

FIG. 1

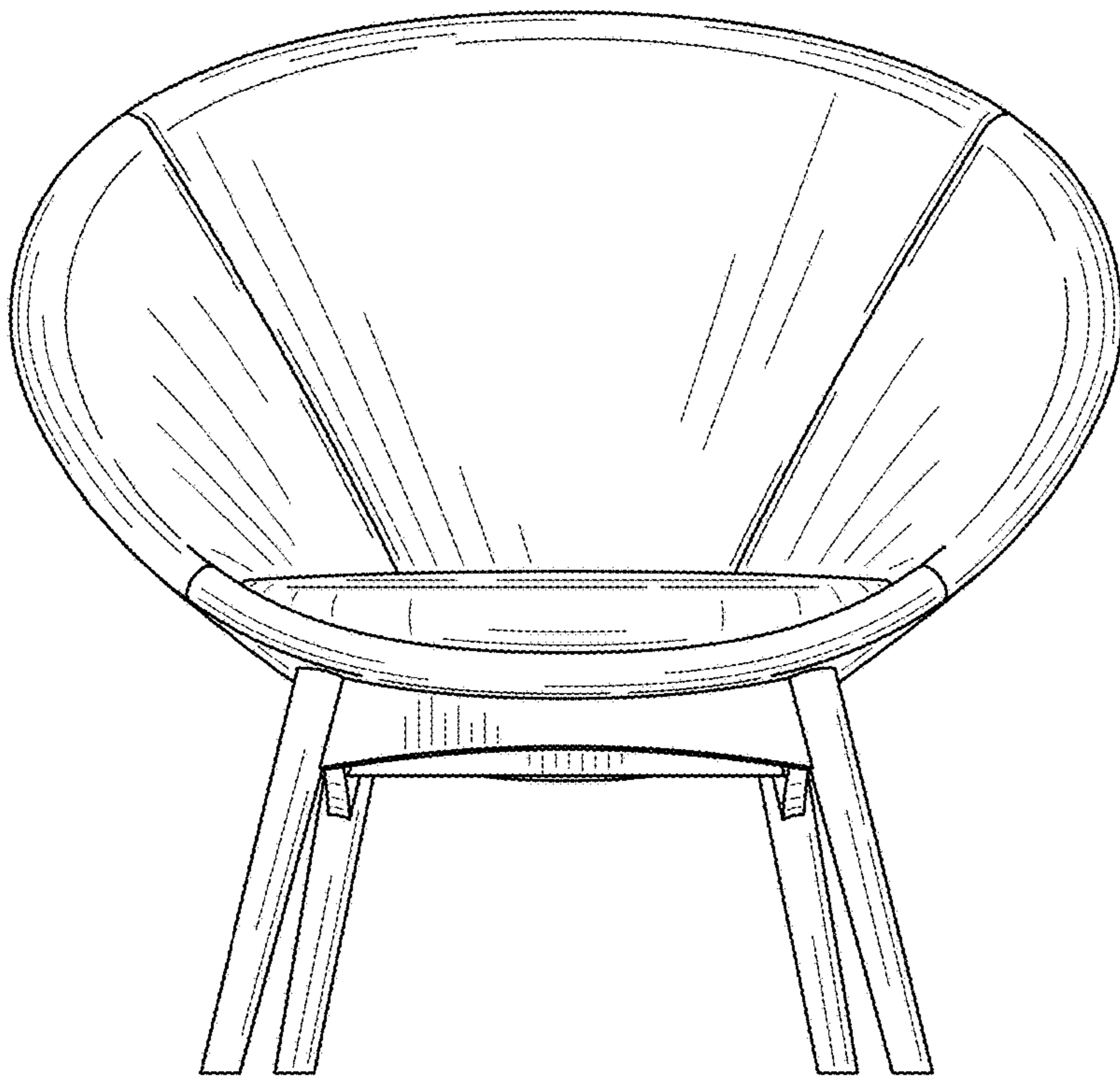

FIG. 2

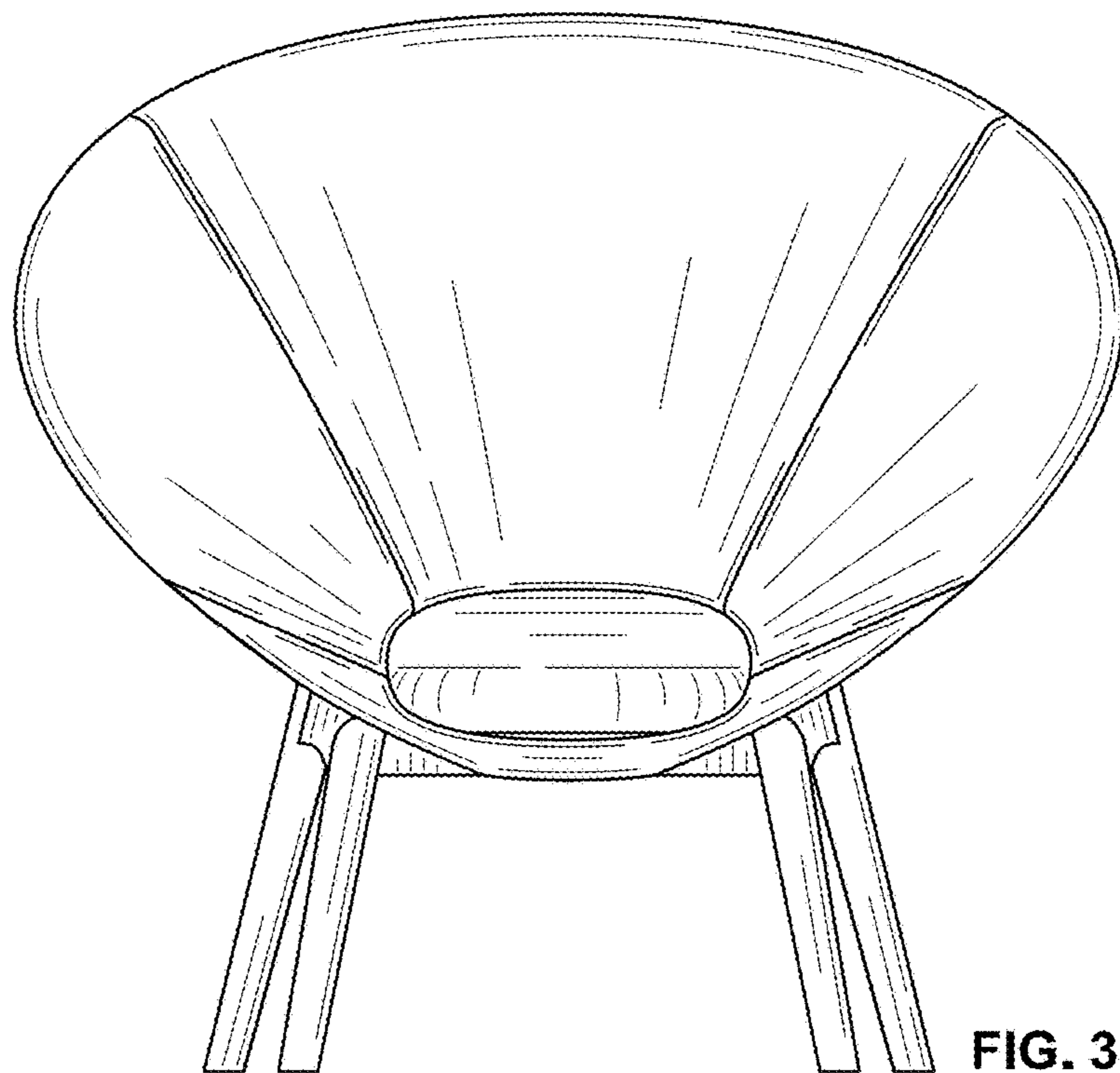

FIG. 3

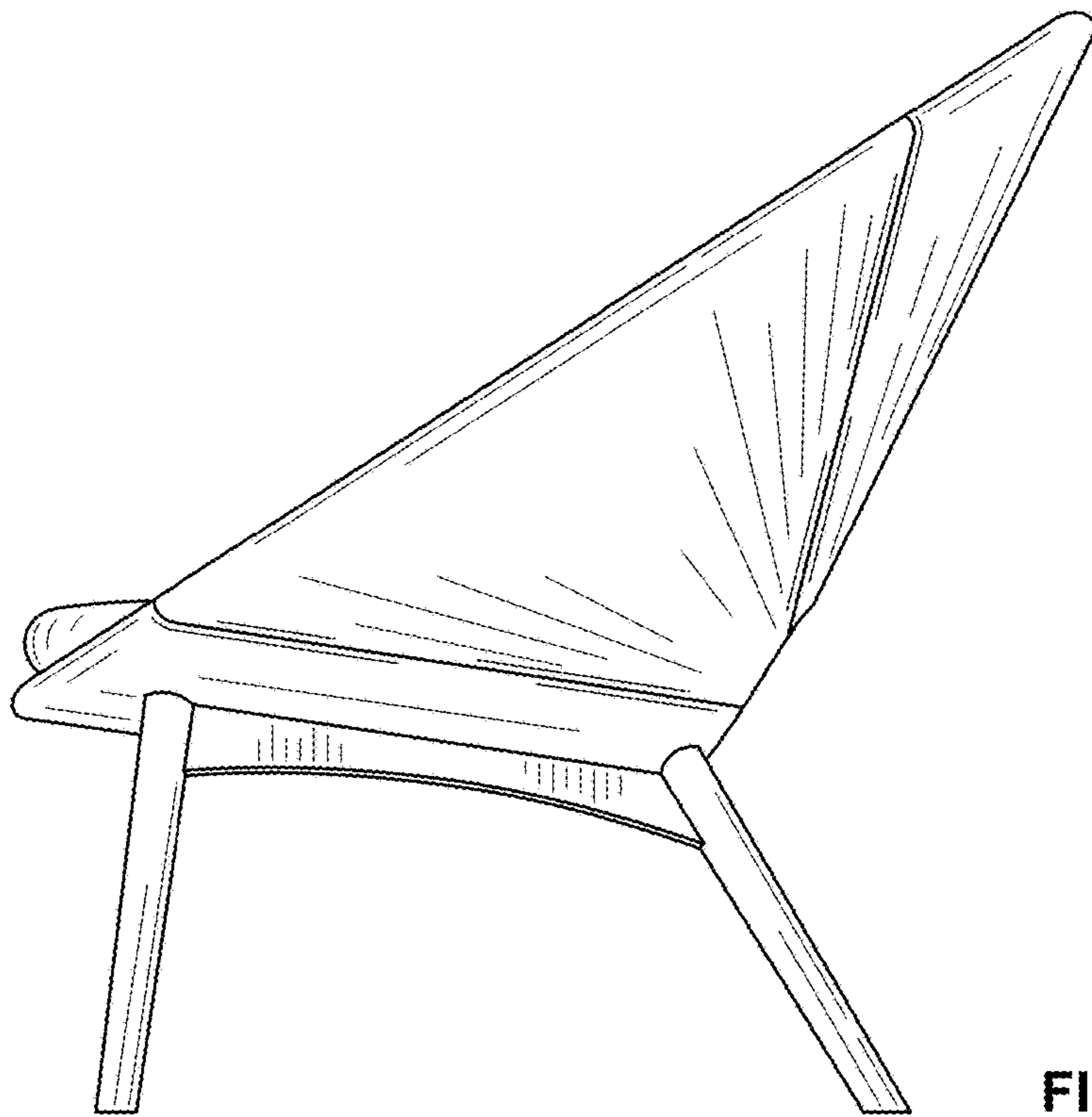

FIG. 4

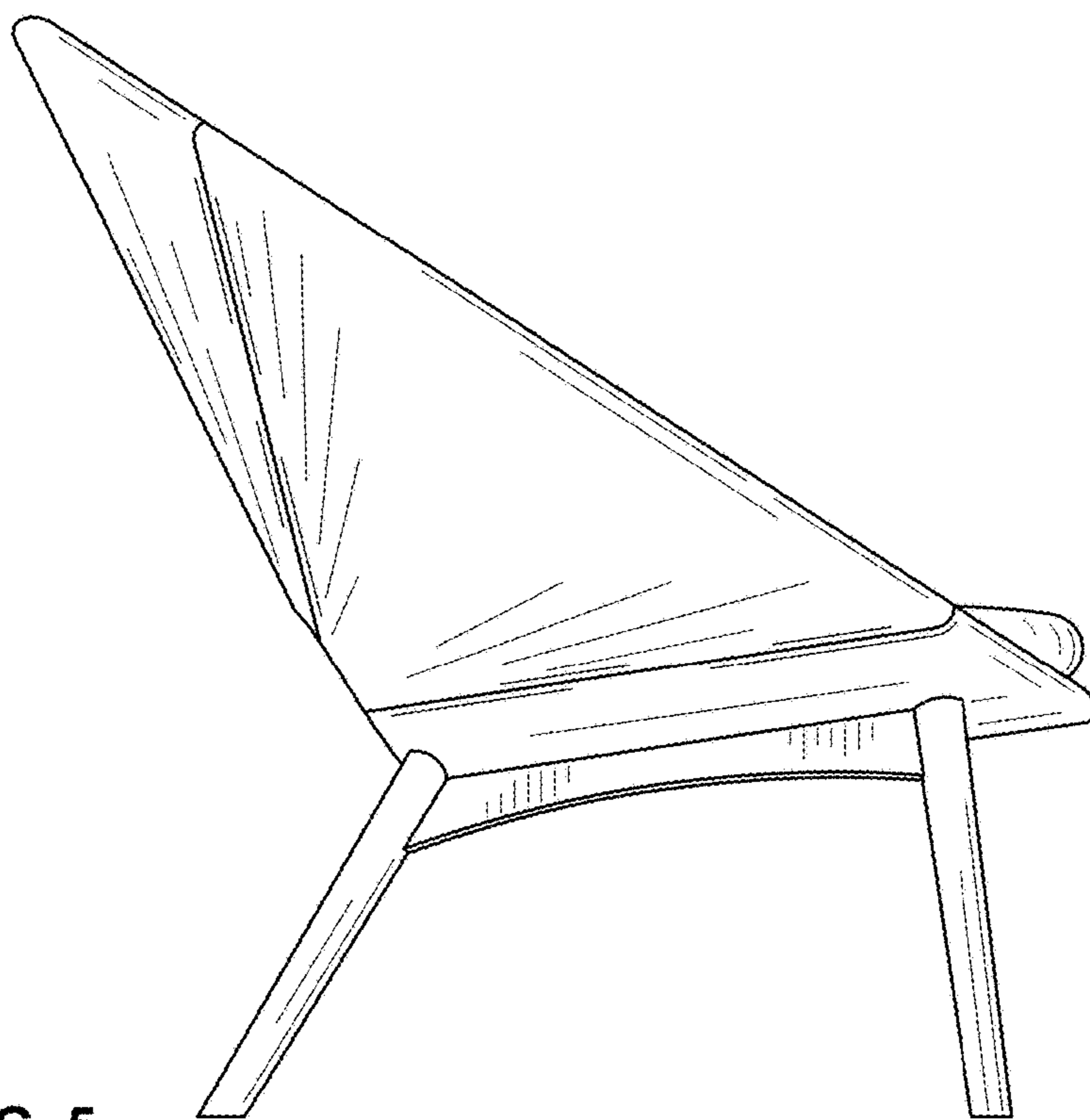

FIG. 5

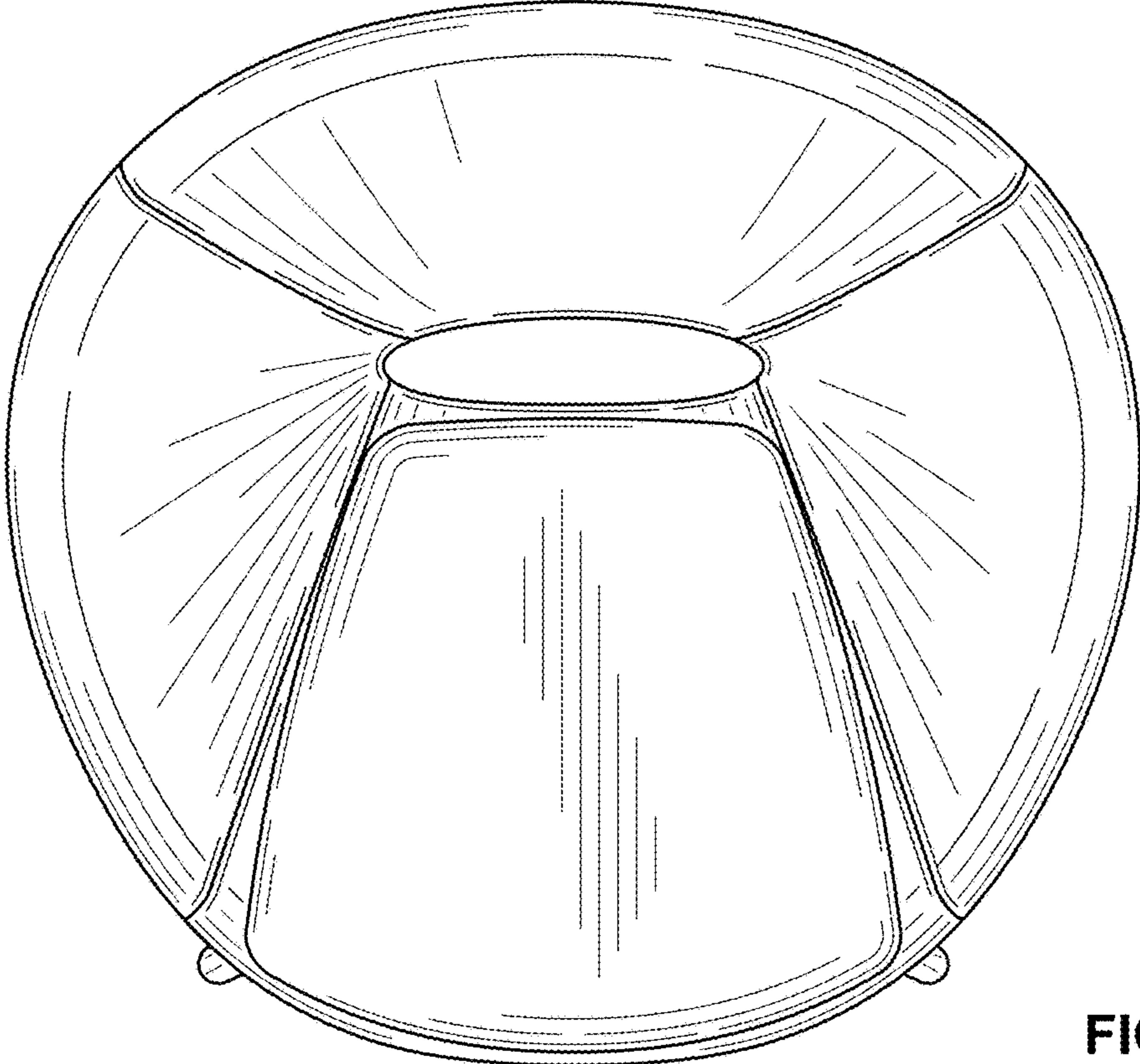

FIG. 6

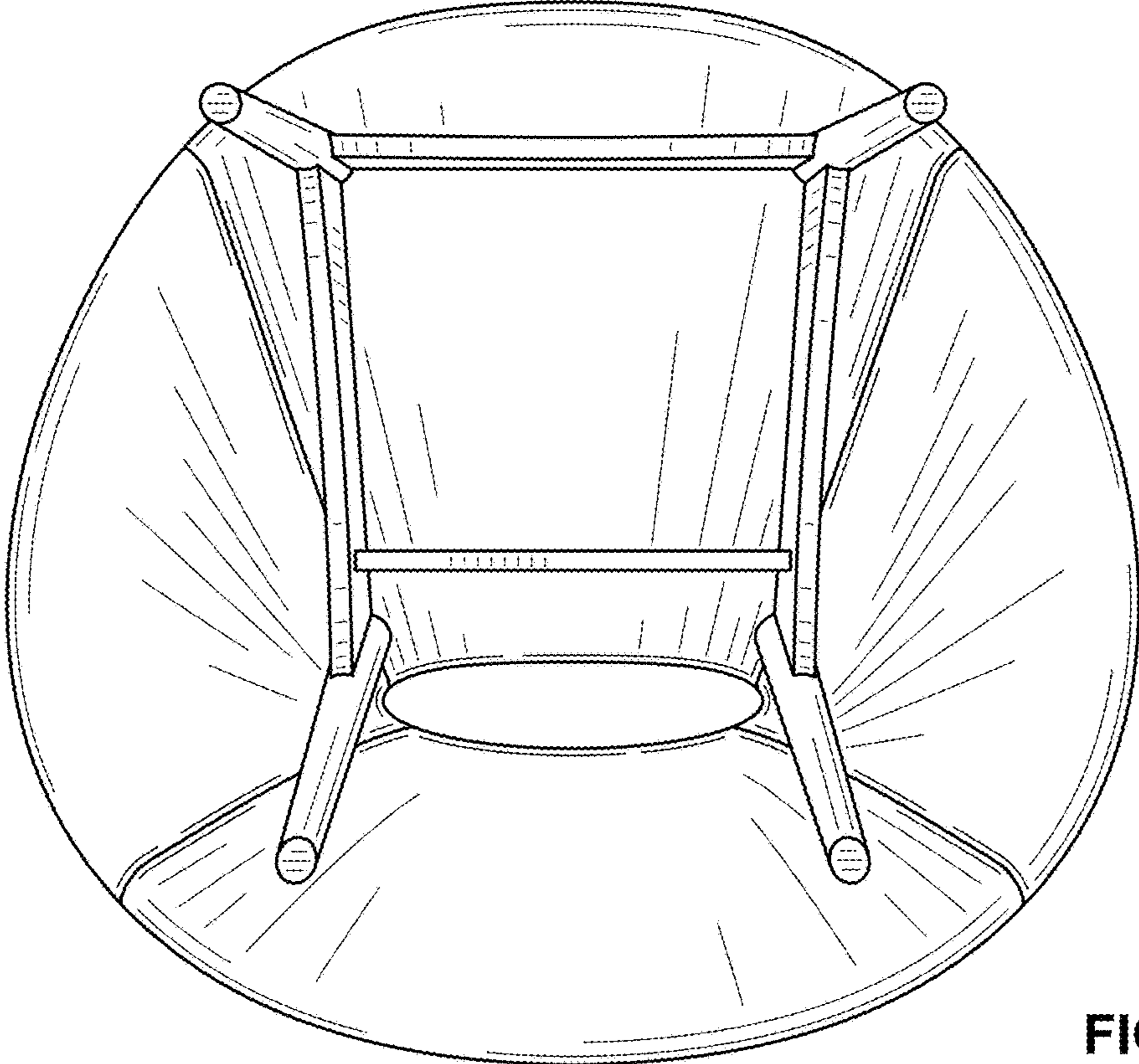

FIG. 7