



US00D821758S

(12) **United States Design Patent**  
**Szymanski et al.**

(10) **Patent No.:** **US D821,758 S**  
(45) **Date of Patent:** **\*\* Jul. 3, 2018**

(54) **WATER-DISPENSING SHOWER BRUSH**

(71) Applicants: **Aaron Szymanski**, Thomaston, CT (US); **LoriAnn Lombardo**, East Hanover, NJ (US); **Anand Khubani**, Towaco, NJ (US); **Lana Rascionato**, Totowa, NJ (US)

(72) Inventors: **Aaron Szymanski**, Thomaston, CT (US); **LoriAnn Lombardo**, East Hanover, NJ (US); **Anand Khubani**, Towaco, NJ (US); **Lana Rascionato**, Totowa, NJ (US)

(73) Assignee: **IdeaVillage Products Corp.**, Wayne, NJ (US)

(\*) Notice: This patent is subject to a terminal disclaimer.

(\*\*) Term: **15 Years**

(21) Appl. No.: **29/620,444**

(22) Filed: **Dec. 20, 2016**

(51) **LOC (11) Cl.** ..... **04-02**

(52) **U.S. Cl.**  
USPC ..... **D4/138; D4/114**

(58) **Field of Classification Search**  
USPC ..... D4/100, 114, 115, 116, 133, 127, 128, D4/130, 132, 134, 135, 138, 199; D23/223, 228; D28/63  
CPC ..... A47K 7/046; A47K 7/04; A46B 13/06; A46B 11/063; A46B 22/1006; A46B 13/008; A46B 11/0013; A46B 11/0062  
See application file for complete search history.

(56) **References Cited**

**U.S. PATENT DOCUMENTS**

1,191,860 A \* 7/1916 Wesley ..... A46B 13/06  
15/29  
2,678,457 A \* 5/1954 Demo ..... A46B 13/06  
15/180

2,682,675 A \* 7/1954 Prucha ..... A46B 13/06  
15/180  
3,864,780 A \* 2/1975 Watkins ..... A46B 13/06  
15/29  
4,417,826 A \* 11/1983 Floros ..... A46B 13/06  
15/29  
5,033,897 A \* 7/1991 Chen ..... A46B 11/063  
239/117  
5,697,115 A \* 12/1997 Sciarra ..... A46B 13/008  
15/21.1  
D493,621 S \* 8/2004 Wilson ..... D4/116  
(Continued)

**OTHER PUBLICATIONS**

Spin Spa Body Brush with 5 Attachments, [on-line]. Retrieved from the Internet Sep. 28, 2017. URL: <[http://www.ebay.com/itm/Spin-Spa-Body-Brush-with-5-Attachments/322592630693?\\_trk](http://www.ebay.com/itm/Spin-Spa-Body-Brush-with-5-Attachments/322592630693?_trk)>. (3 pages) (Year: 2017).\*

(Continued)

*Primary Examiner* — Karen E Eldridge Powers  
(74) *Attorney, Agent, or Firm* — Dan M. DeLaRosa

(57) **CLAIM**

The ornamental design for a water-dispensing shower brush, as shown and described.

**DESCRIPTION**

FIG. 1 is a front perspective view of a water-dispensing shower brush of the present invention showing my new design;  
FIG. 2 is a front side elevation view thereof;  
FIG. 3 is back side elevation view thereof;  
FIG. 4 is a side elevation view thereof;  
FIG. 5 is another side elevation view thereof  
FIG. 6 is a top plan view thereof; and,  
FIG. 7 is a bottom plan view thereof.

**1 Claim, 6 Drawing Sheets**

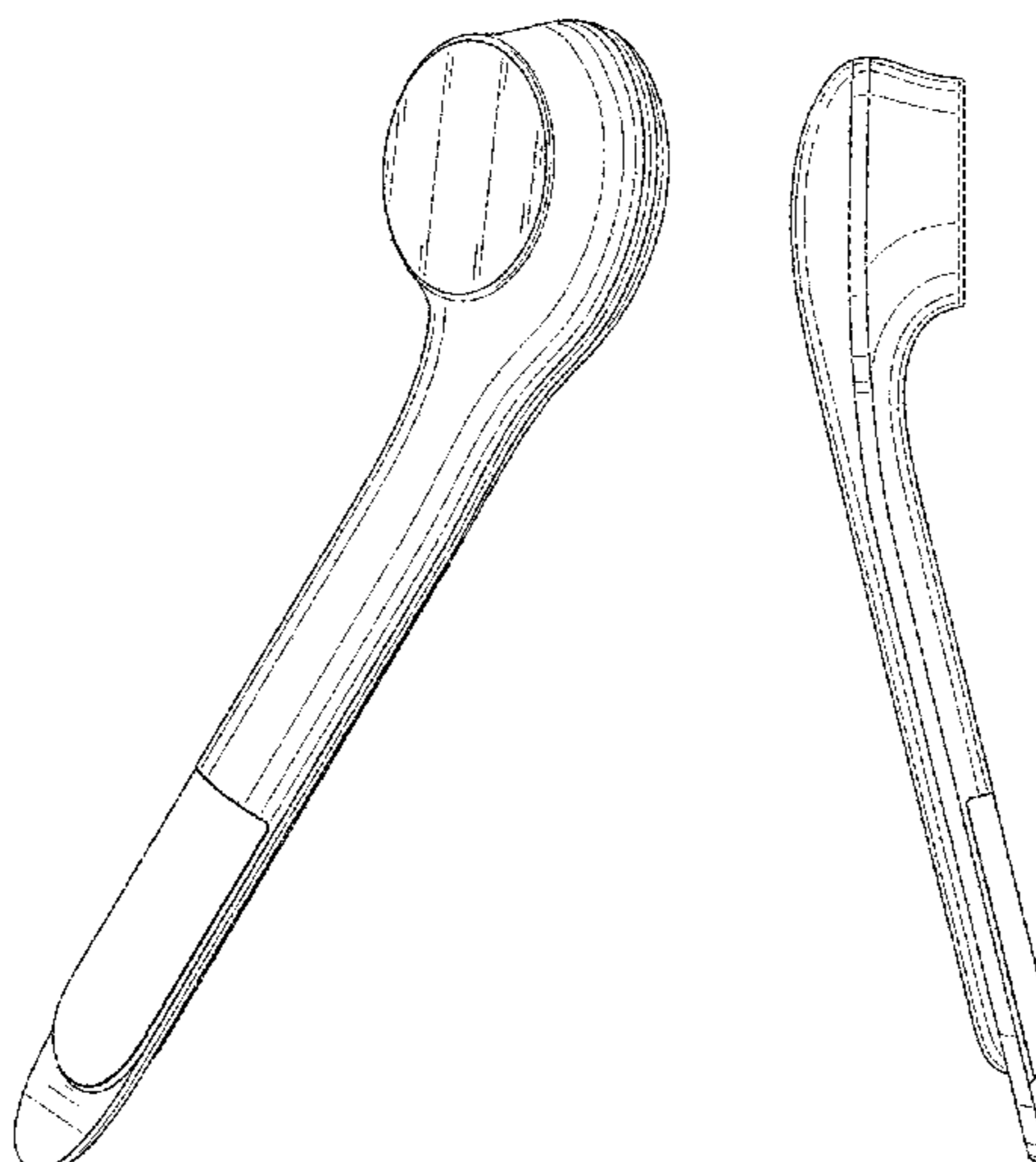

(56)

**References Cited**

U.S. PATENT DOCUMENTS

7,941,887	B2 *	5/2011	Tsai	.....	A46B 13/06	
						15/29
8,439,588	B2 *	5/2013	Houman	.....	A46B 13/06	
						15/29
8,511,927	B2 *	8/2013	Houman	.....	A46B 13/06	
						15/28
8,985,886	B1 *	3/2015	Derrick	.....	A46B 15/00	
						4/606
9,138,257	B2 *	9/2015	Revivo	.....	A61B 17/54	
9,370,282	B1 *	6/2016	Petersen	.....	A47K 7/028	
9,433,281	B1 *	9/2016	Barras	.....	A46B 11/063	
9,643,195	B2 *	5/2017	Streetmaker	.....	B05B 1/185	
2006/0285910	A1 *	12/2006	Khubani	.....	A46B 11/0013	
						401/6
2014/0196229	A1 *	7/2014	Shen	.....	B05B 1/18	
						15/29
2014/0330289	A1 *	11/2014	Revivo	.....	A61B 17/54	
						606/131
2015/0173842	A1 *	6/2015	Carlucci	.....	A46B 13/008	
						606/131

OTHER PUBLICATIONS

Spin Spa by Idea Village [on-line]. Available on the Internet at least as early as Feb. 10, 2014; retrieved from the Internet Sep. 28, 2017. URL: <<https://web.archive.org/web/20140210014816/https://www.ideavillage.com/Idea-Village-Products.dtm>>. (4 pages) (Year: 2014).\*

\* cited by examiner

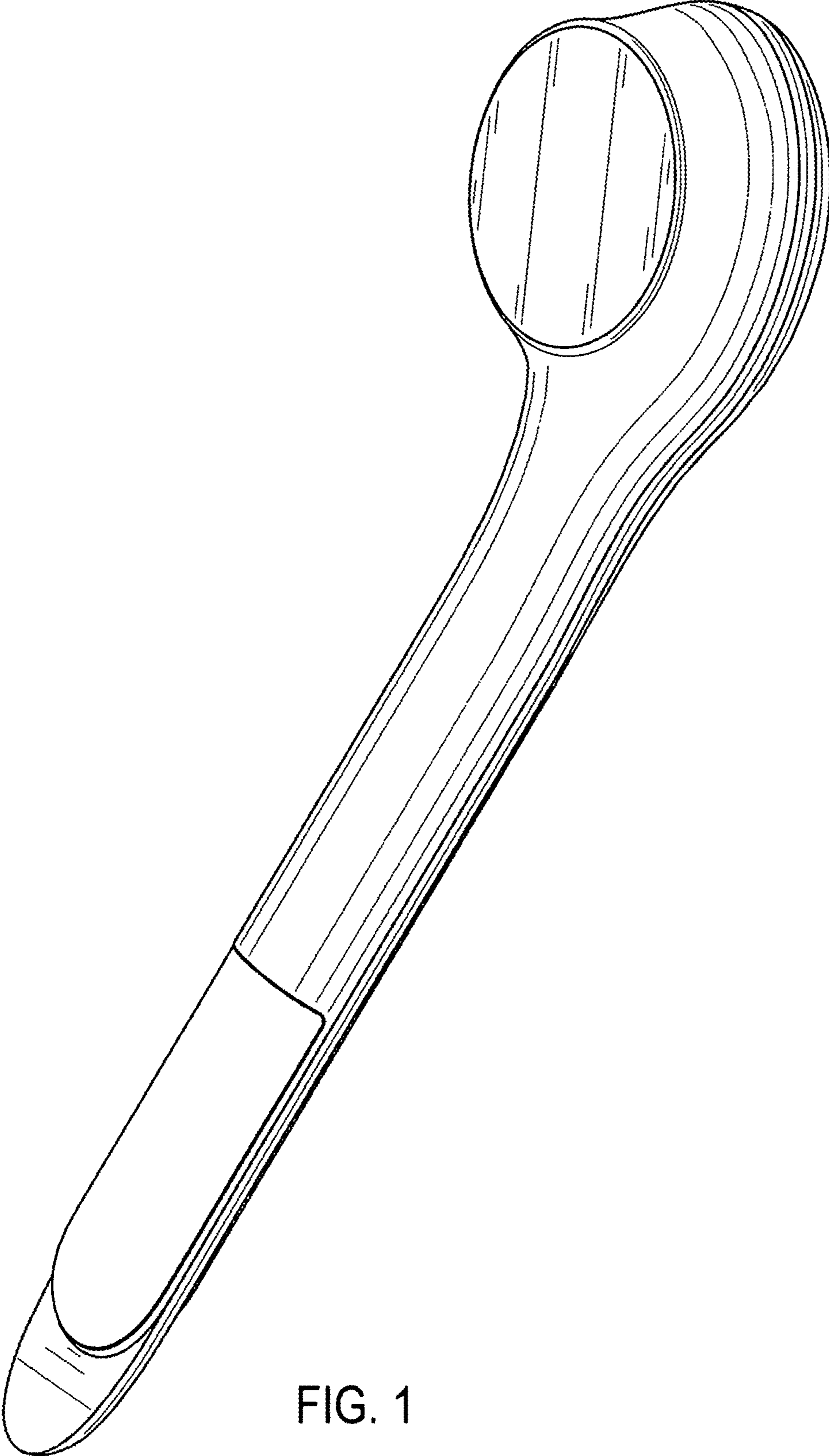

FIG. 1

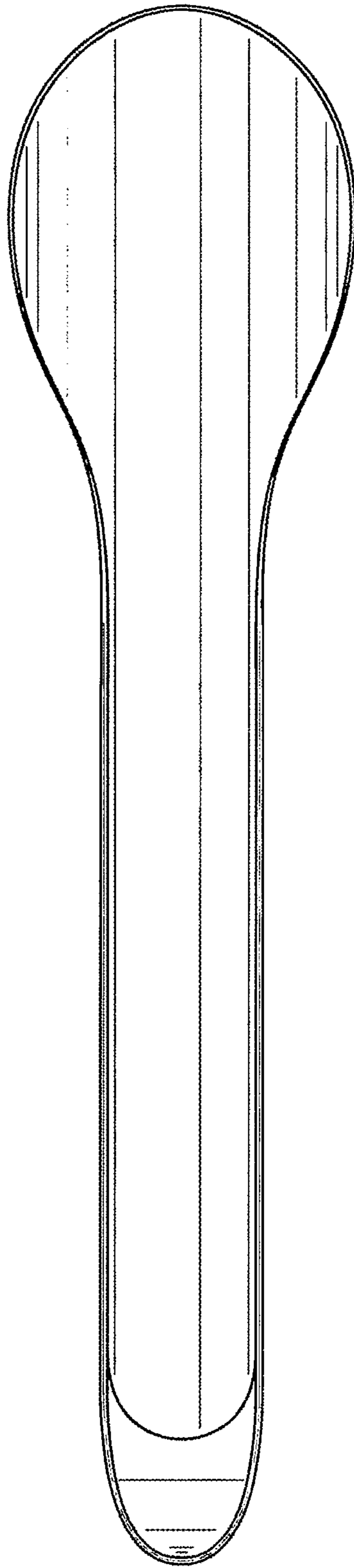

FIG. 2

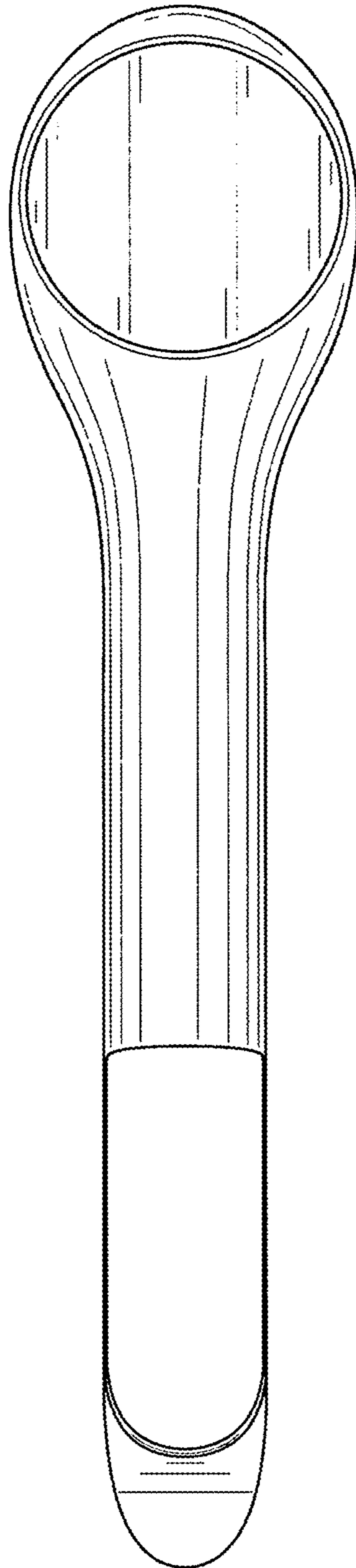

FIG. 3

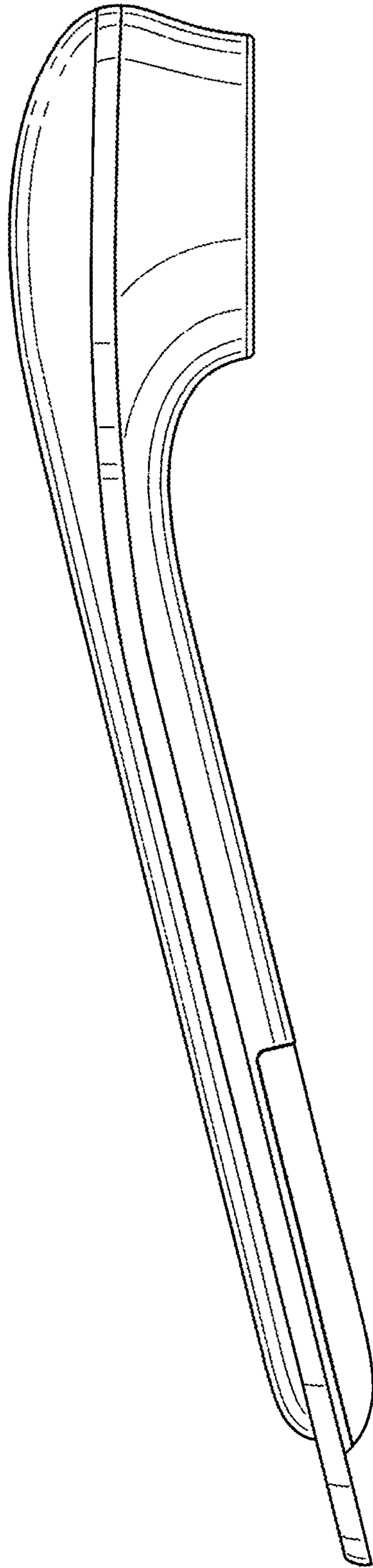

FIG. 4

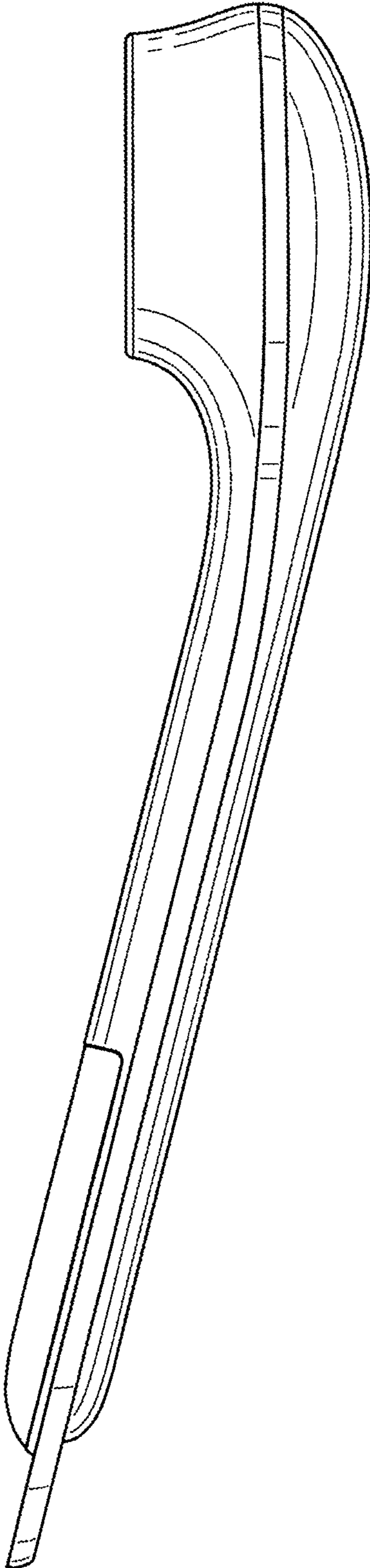

FIG. 5

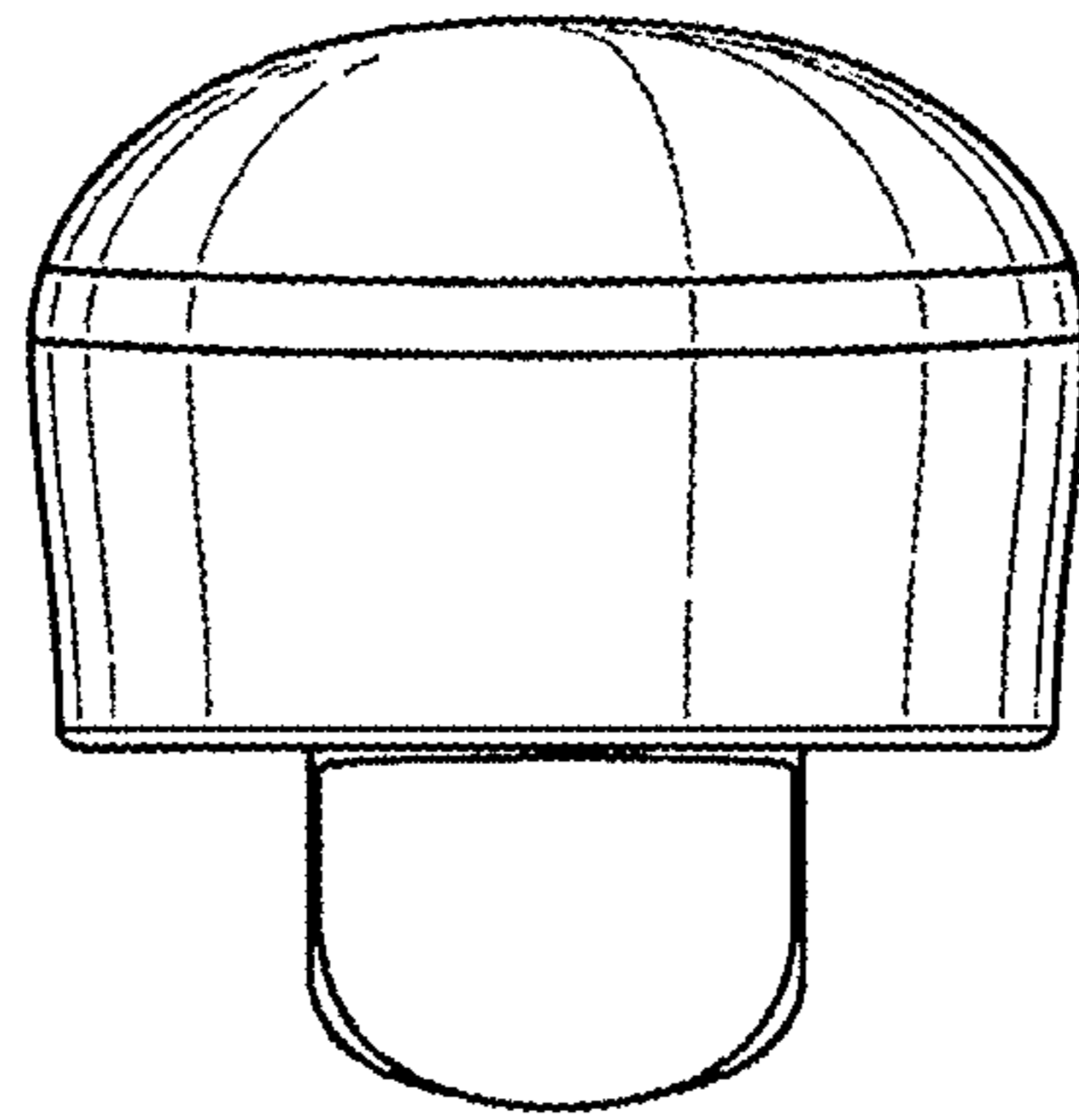

FIG. 6

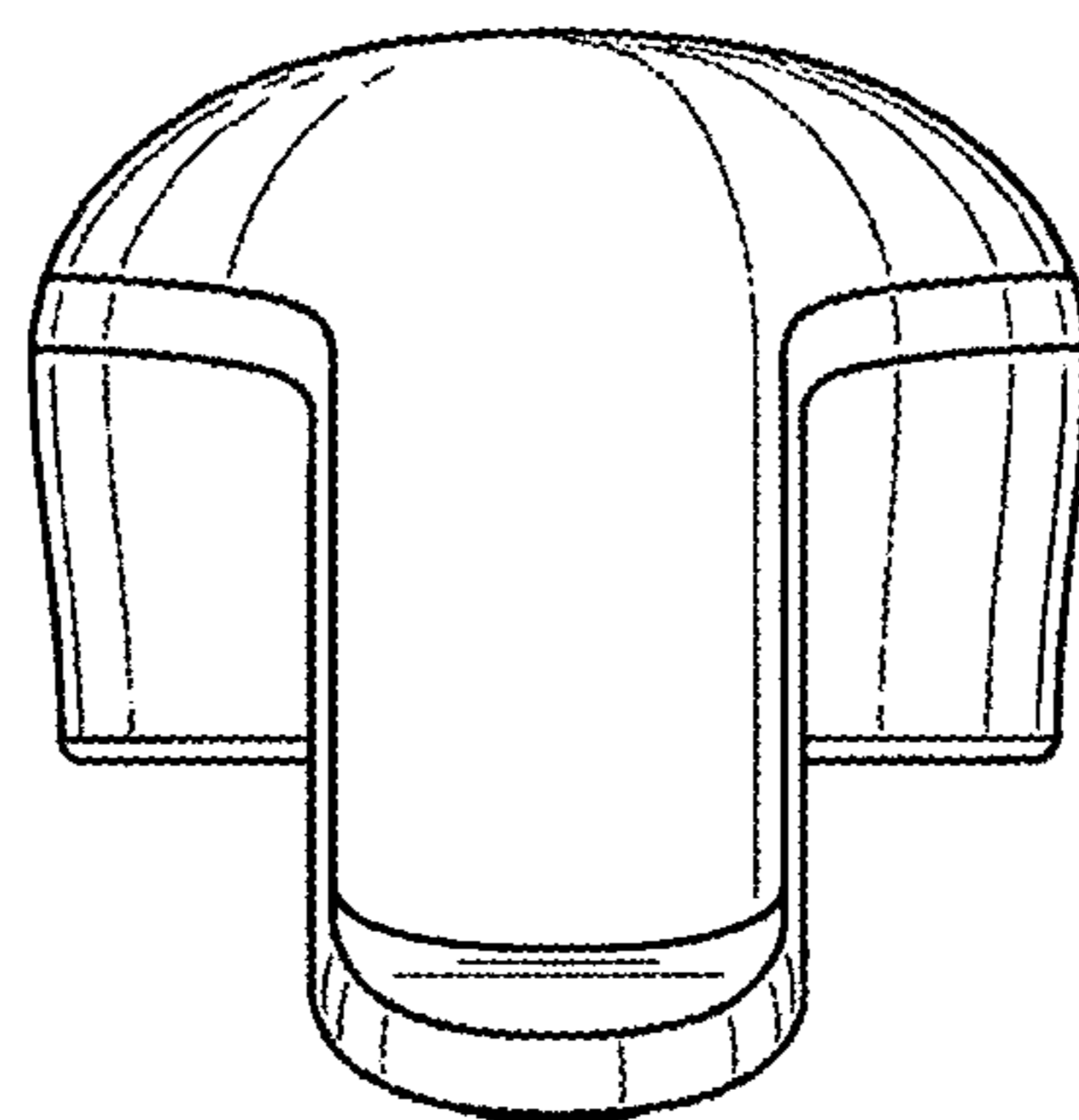

FIG. 7