



US00D821746S

(12) **United States Design Patent**
Heyman

(10) **Patent No.:** **US D821,746 S**
(45) **Date of Patent:** **** Jul. 3, 2018**

(54) **HANDBAG**
(71) Applicant: **Edie Parker LLC**, New York, NY (US)
(72) Inventor: **Brett Heyman**, New York, NY (US)
(73) Assignee: **Edie Parker LLC**, New York, NY (US)
(**) Term: **15 Years**

D170,532 S * 10/1953 Hommer D3/242
D506,670 S * 6/2005 Borkoski D9/430
D540,033 S * 4/2007 Taniguchi D3/238
D675,820 S * 2/2013 Campanella D3/234
D717,163 S * 11/2014 Paulsen D9/431
D732,820 S * 6/2015 Ghoulmore D3/234
D743,164 S * 11/2015 Ghoulmore D3/234
D764,909 S * 8/2016 Tulin D9/430

* cited by examiner

(21) Appl. No.: **29/598,574**
(22) Filed: **Mar. 27, 2017**
(51) **LOC (11) Cl.** **03-01**
(52) **U.S. Cl.**
USPC **D3/240; D3/234; D3/238**
(58) **Field of Classification Search**
USPC D3/238, 240-243, 245-245
CPC .. A45C 1/024; A45C 3/08; B65D 5/00; B65D
5/0209; B65D 5/029
See application file for complete search history.

Primary Examiner — Holly H Baynham
(74) *Attorney, Agent, or Firm* — Springut Law PC;
Milton Springut

(57) **CLAIM**
The ornamental design of a handbag, as shown and described.

DESCRIPTION

FIG. 1 is a perspective view thereof.
FIG. 2 is a front view thereof.
FIG. 3 is a rear view thereof.
FIG. 4 is a left side view thereof.
FIG. 5 is a right side view thereof.
FIG. 6 is a top view thereof; and,
FIG. 7 is a bottom view thereof.

(56) **References Cited**
U.S. PATENT DOCUMENTS

D63,835 S * 1/1924 Ritter D3/242
D121,798 S * 8/1940 Skib D3/240

1 Claim, 4 Drawing Sheets

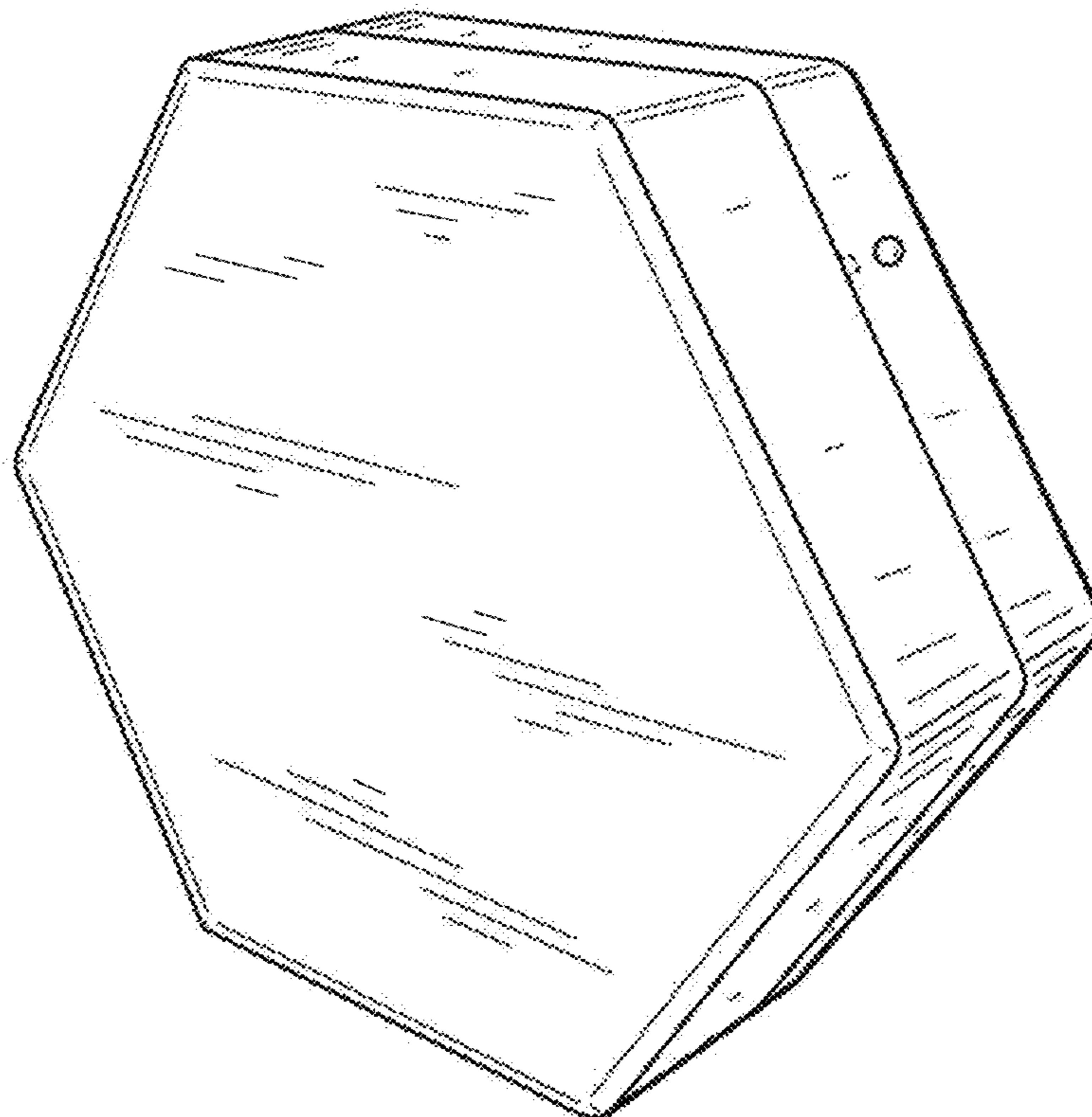

FIG. 1

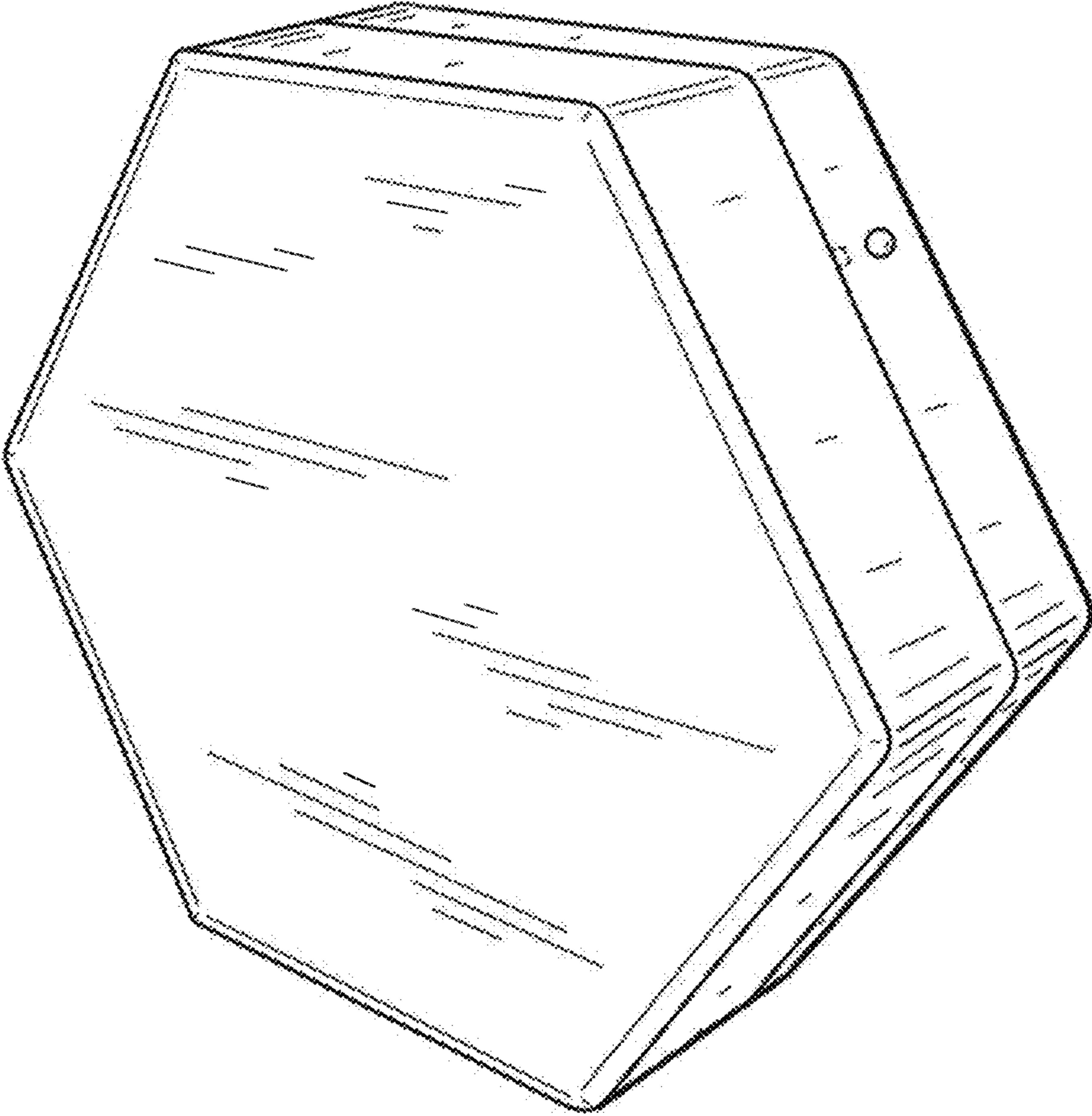

FIG. 2

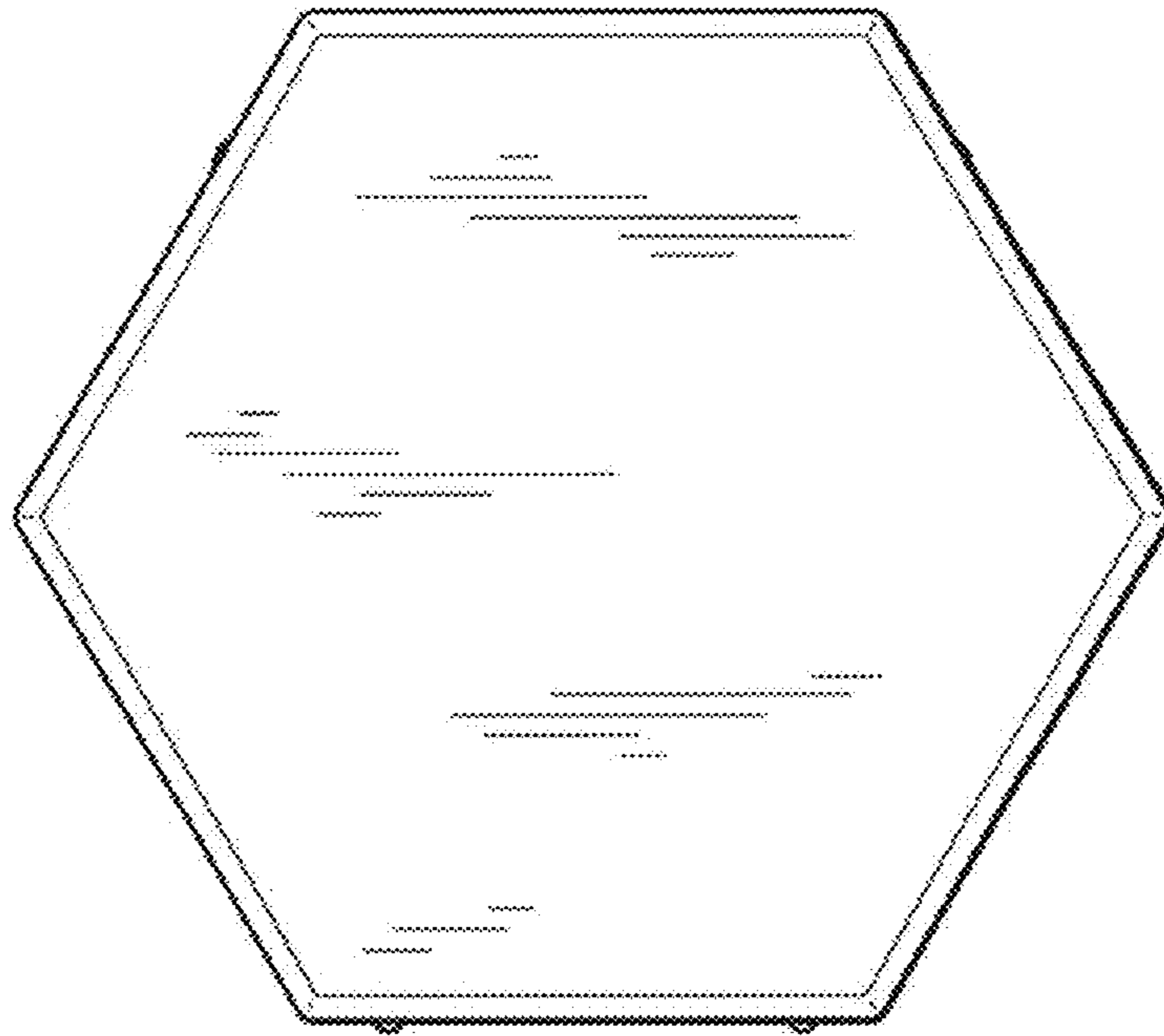

FIG. 3

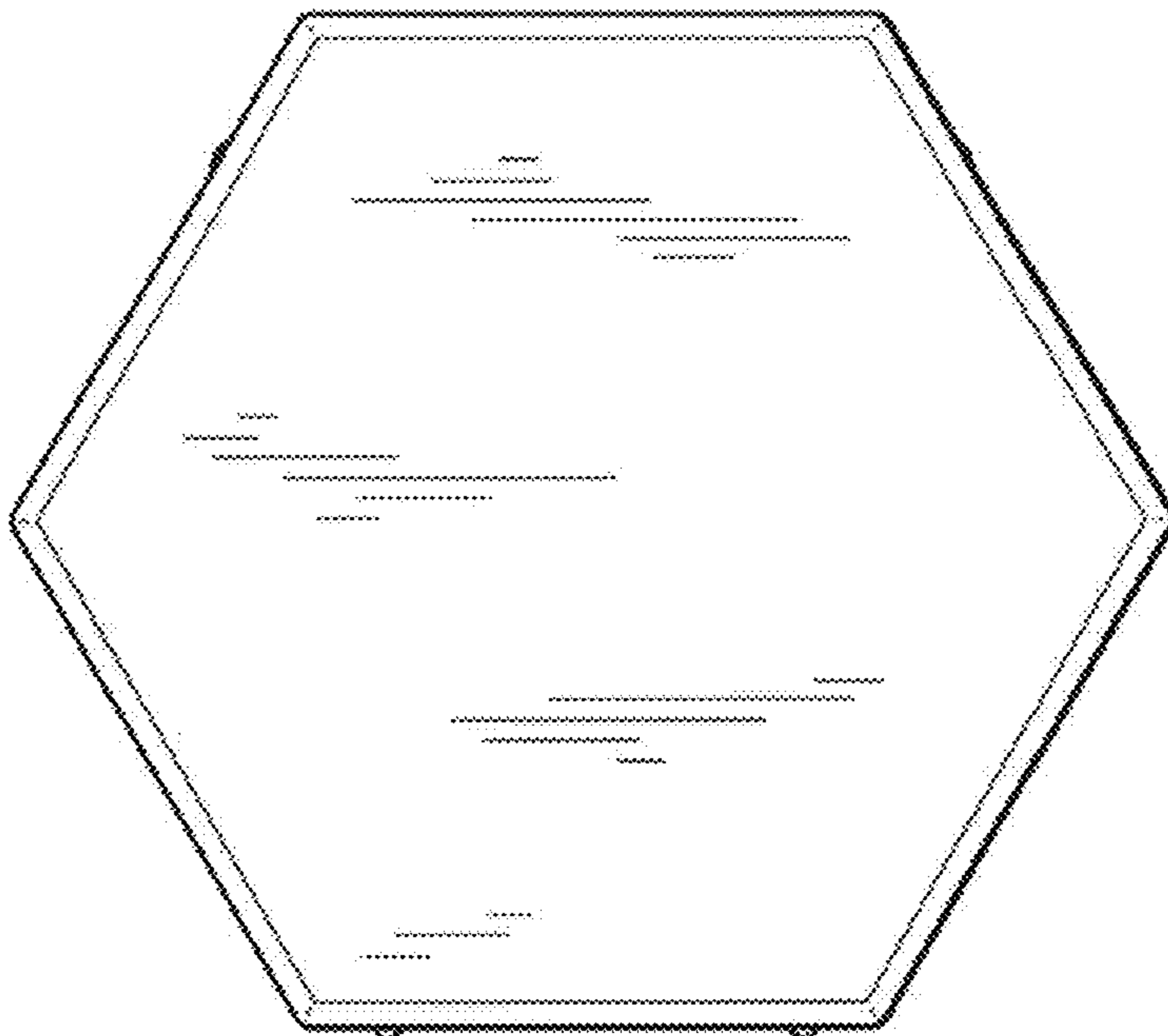

FIG. 4

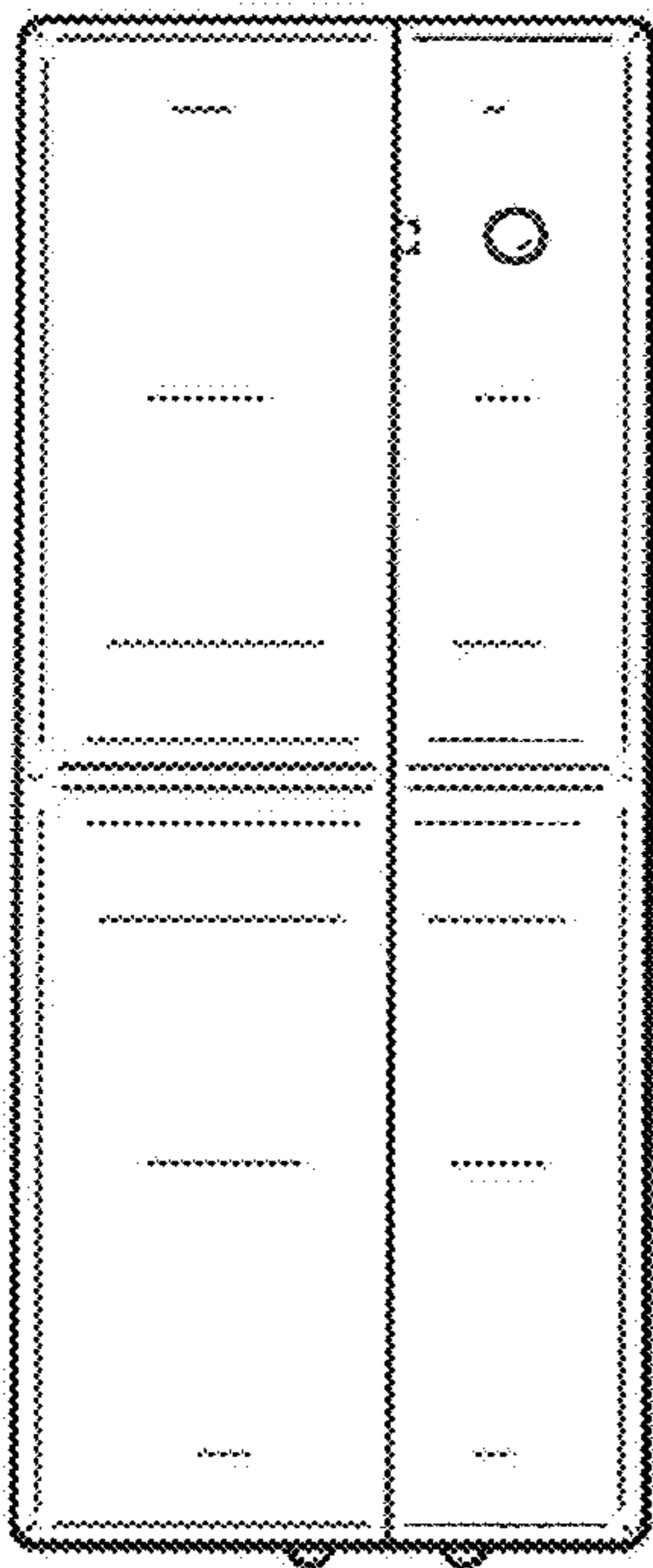

FIG. 5

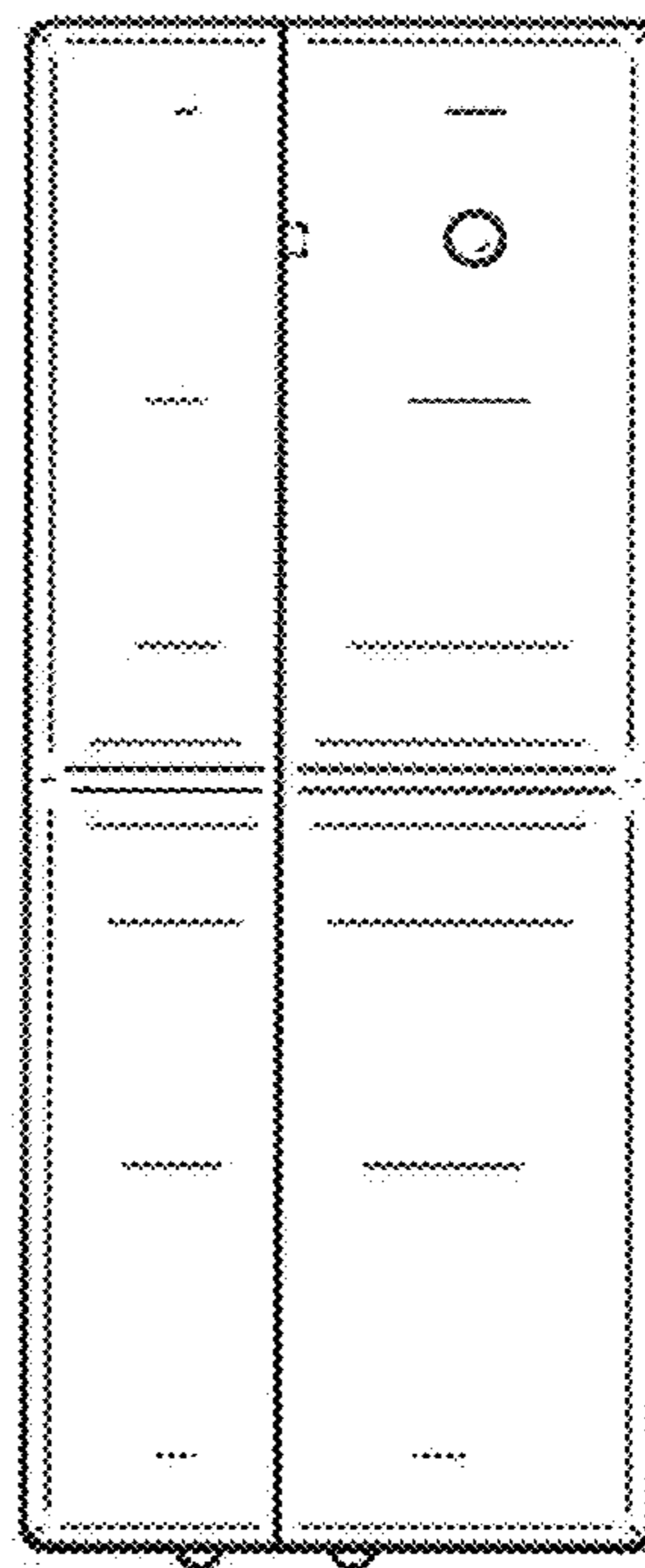

FIG. 6

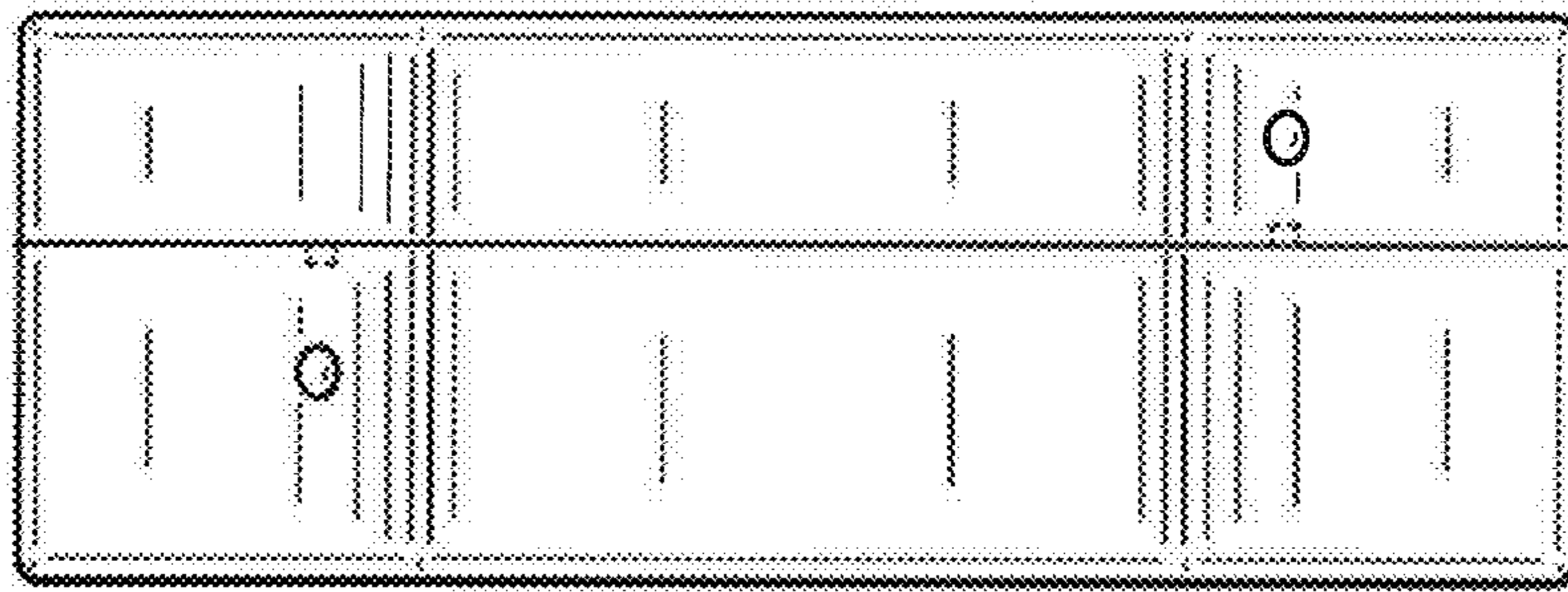

FIG. 7

