



US00D821745S

(12) **United States Design Patent** (10) **Patent No.:** **US D821,745 S**
Dumas (45) **Date of Patent:** **** Jul. 3, 2018**

(54) **BAG**
(71) Applicant: **HERMES SELLIER (SOCIÉTÉ PAR ACTIONS SIMPLIFIÉE)**, Paris (FR)
(72) Inventor: **Pierre-Alexis Dumas**, Paris (FR)
(**) Term: **15 Years**

D698,145 S * 1/2014 Deneve D3/243
D705,537 S * 5/2014 Smith D3/243
D726,410 S * 4/2015 Fusi D3/243
D757,430 S * 5/2016 Spaziani D3/243
D765,969 S * 9/2016 Bonesi D3/243
D772,564 S * 11/2016 Michele D3/243
D778,599 S * 2/2017 Heyman D3/243
D790,215 S * 6/2017 Nair D3/243
D792,093 S * 7/2017 Venturini Fendi D3/243

* cited by examiner

(21) Appl. No.: **35/501,726**
(22) Filed: **Oct. 3, 2016**

Primary Examiner — Manpreet S Matharu
Assistant Examiner — Holly E Thurman

(80) **Hague Agreement Data**
Int. Filing Date: **Oct. 3, 2016**
Int. Reg. No.: **DM/092839**
Int. Reg. Date: **Oct. 3, 2016**
Int. Reg. Pub. Date: **Oct. 14, 2016**

(57) **CLAIM**
The ornamental design of a bag, as shown and described.

(51) **LOC (11) Cl.** **03-01**
(52) **U.S. Cl.**
USPC **D3/232**
(58) **Field of Classification Search**
USPC D3/232–233, 240–243, 245–247,
D3/249–253
CPC A45C 1/024; A45C 3/06
See application file for complete search history.

DESCRIPTION

1. Bag
FIG. 1.1 : Perspective view of a bag of the claimed design;
FIG. 1.2 : Front view of the bag shown in FIG. 1.1;
FIG. 1.3 : Back view of the bag shown in FIG. 1.1;
FIG. 1.4 : Right view of the bag shown in FIG. 1.1;
FIG. 1.5 : Left view of the bag shown in FIG. 1.1;
FIG. 1.6 : Top view of the bag shown in FIG. 1.1;
FIG. 1.7 : Bottom view of the bag shown in FIG. 1.1;
FIG. 1.8 : Enlarged view of a latch of the bag shown in FIG. 1.1;
FIG. 1.9 : Enlarged view of the latch of the bag shown in FIG. 1.1 in an alternate configuration; and
FIG. 1.10 : Enlarged view of the latch of the bag shown in FIG. 1.1 in an alternate configuration.

The claimed design is shown in the figures by solid lines as well as by dashed lines that represent stitching. The dot-dashed lines shown in FIGS. 1.7-1.10 are for illustrative purposes only and form no part of the claimed design.

(56) **References Cited**
U.S. PATENT DOCUMENTS

D107,045 S * 11/1937 Love D3/243
D115,111 S * 6/1939 Headley, III D3/243
D151,656 S * 11/1948 Rath D3/243
D483,563 S * 12/2003 Dwight D3/243
D533,997 S * 12/2006 Jacobs D3/246
D658,872 S * 5/2012 Schiffman D3/243
D669,265 S * 10/2012 Pent D3/243

1 Claim, 10 Drawing Sheets

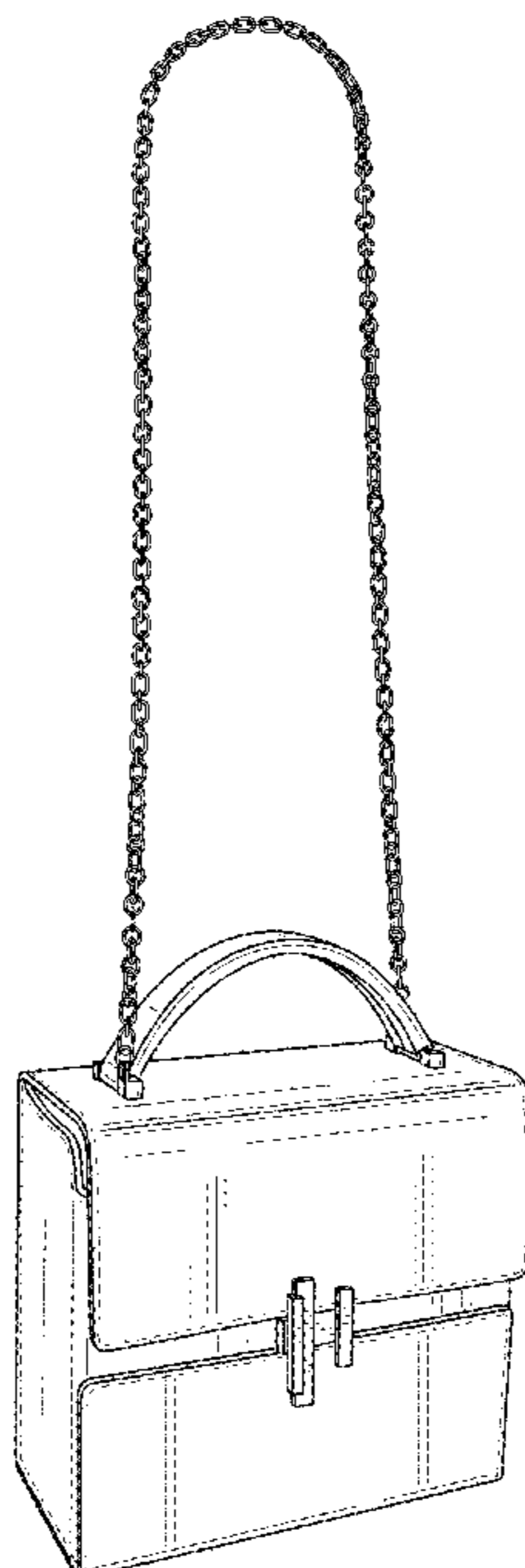



FIG. 1.1

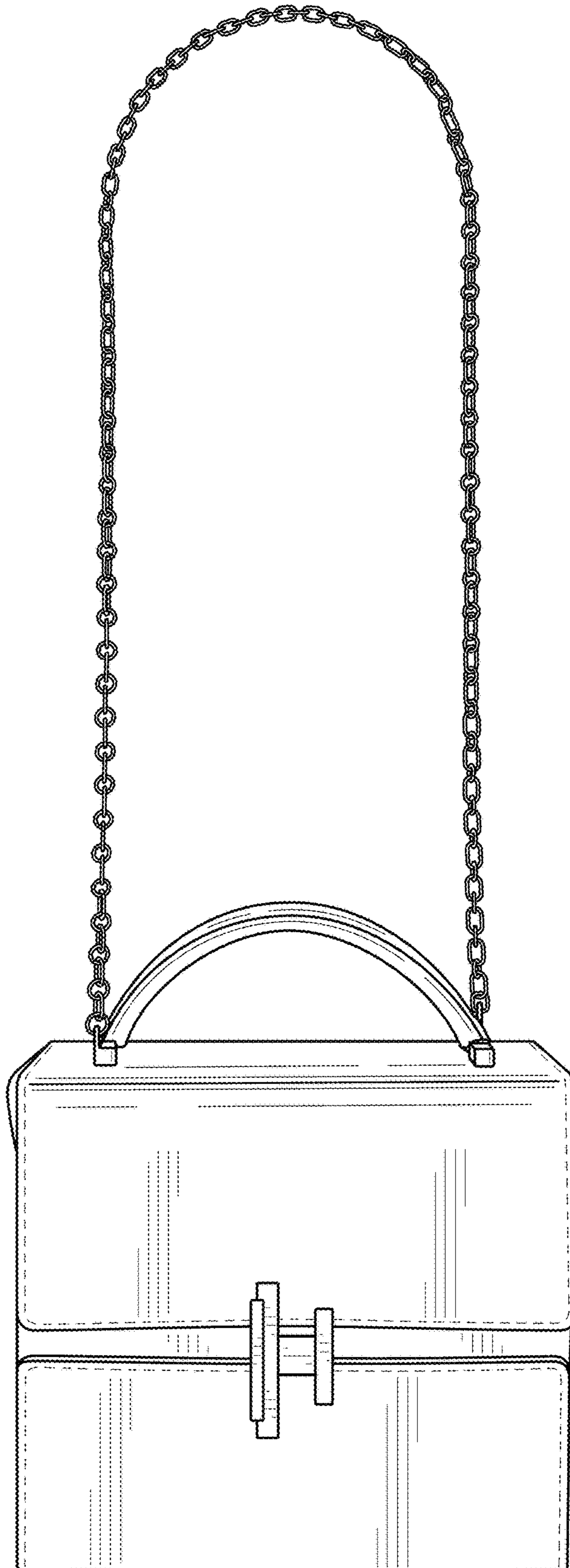

FIG. 1.2

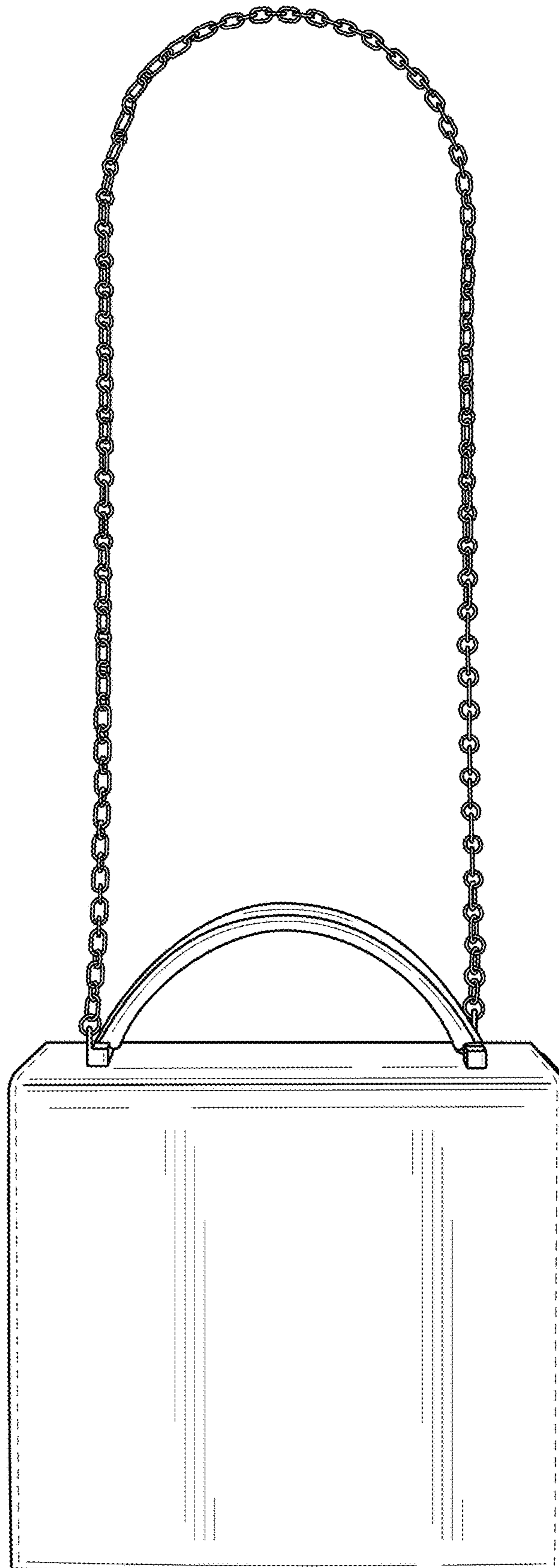

FIG. 1.3

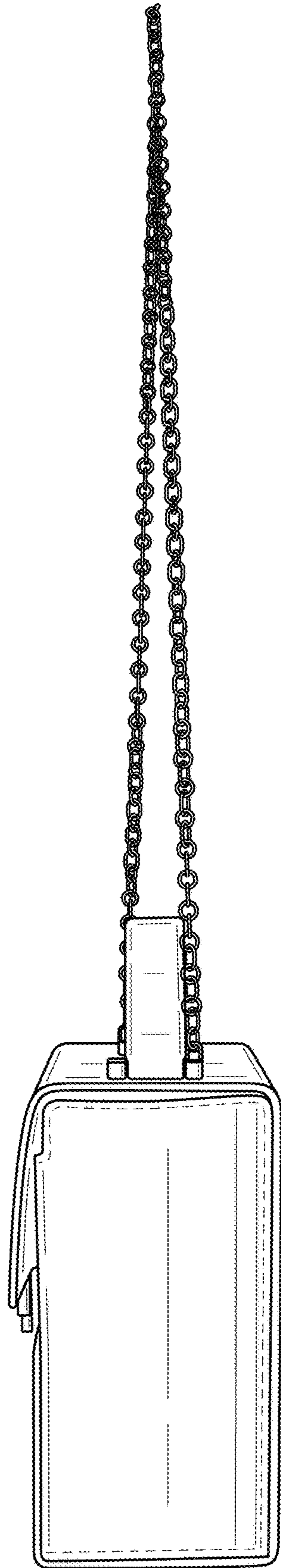

FIG. 1.4

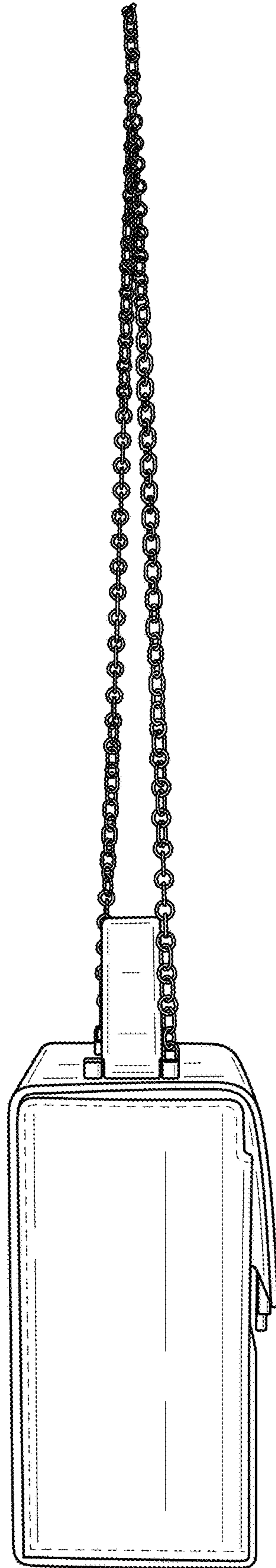

FIG. 1.5

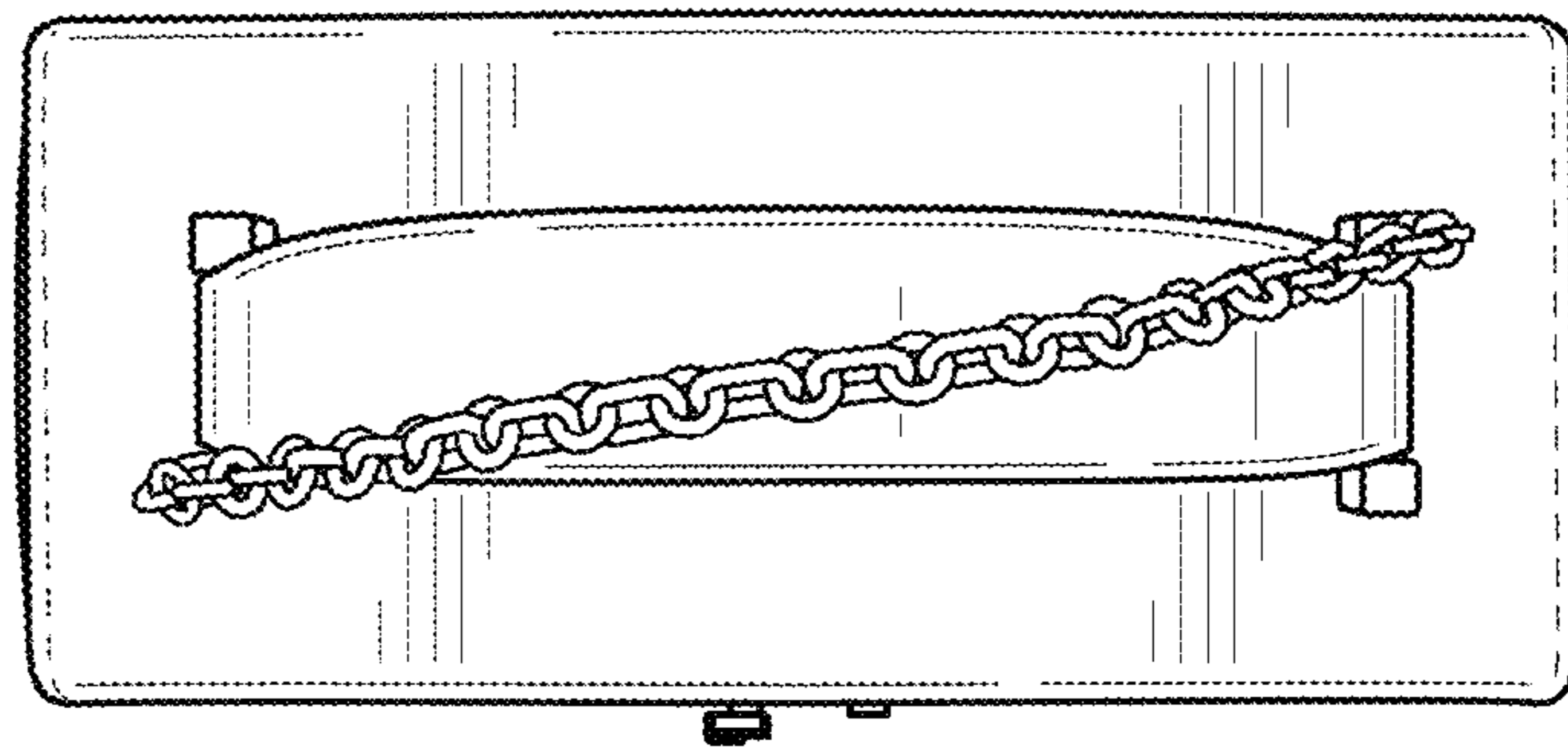

FIG. 1.6

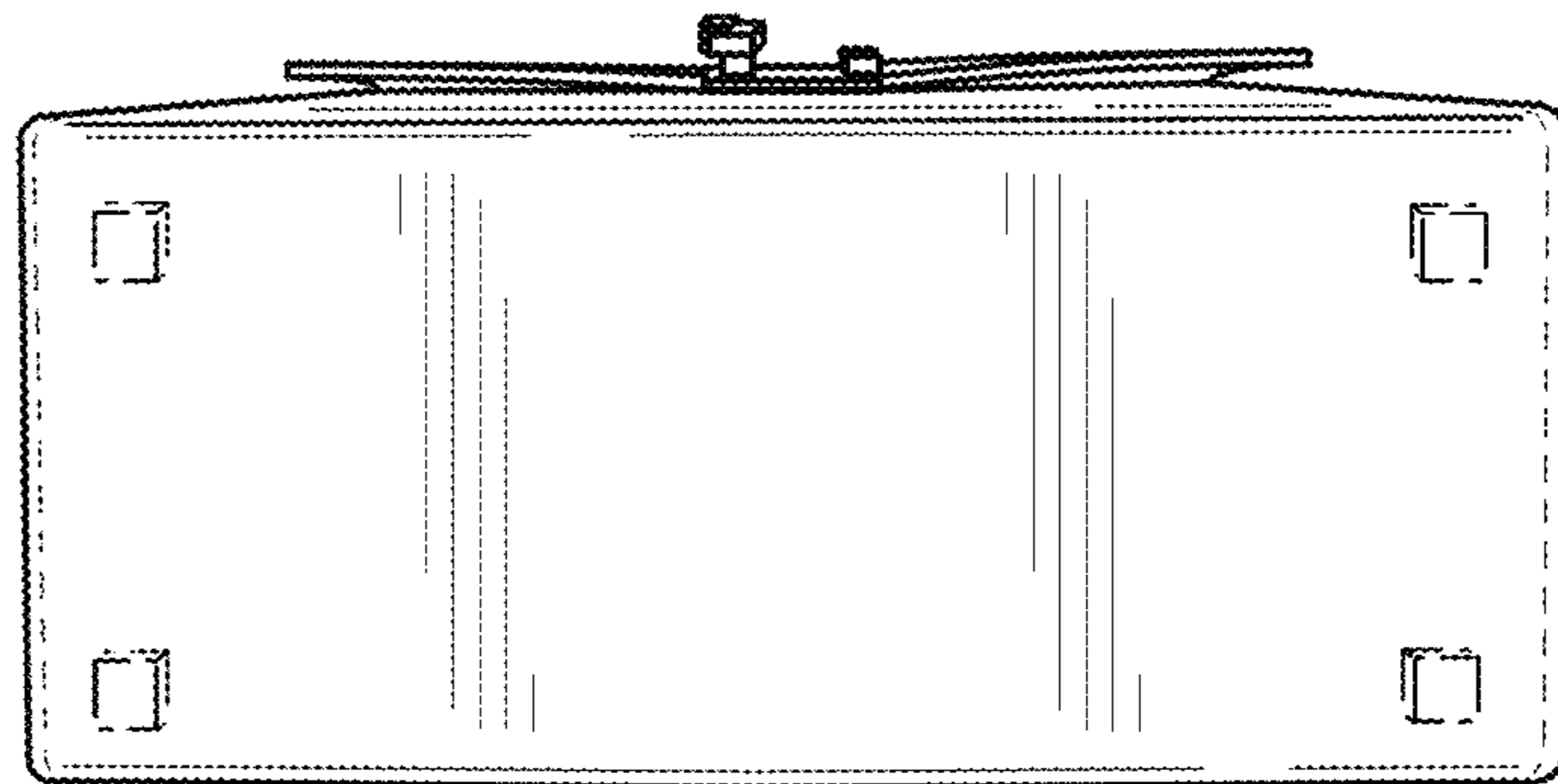

FIG. 1.7

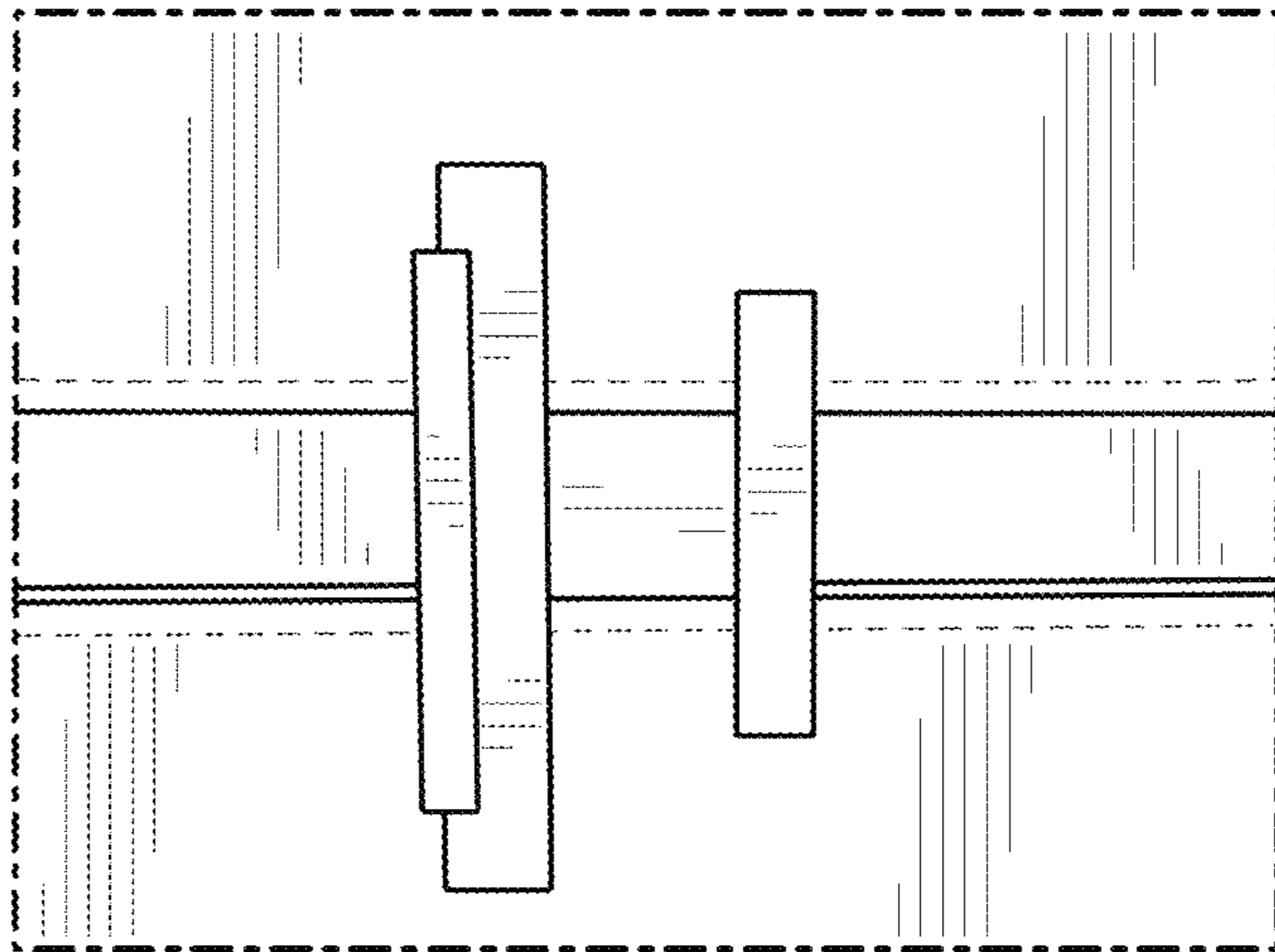

FIG. 1.8

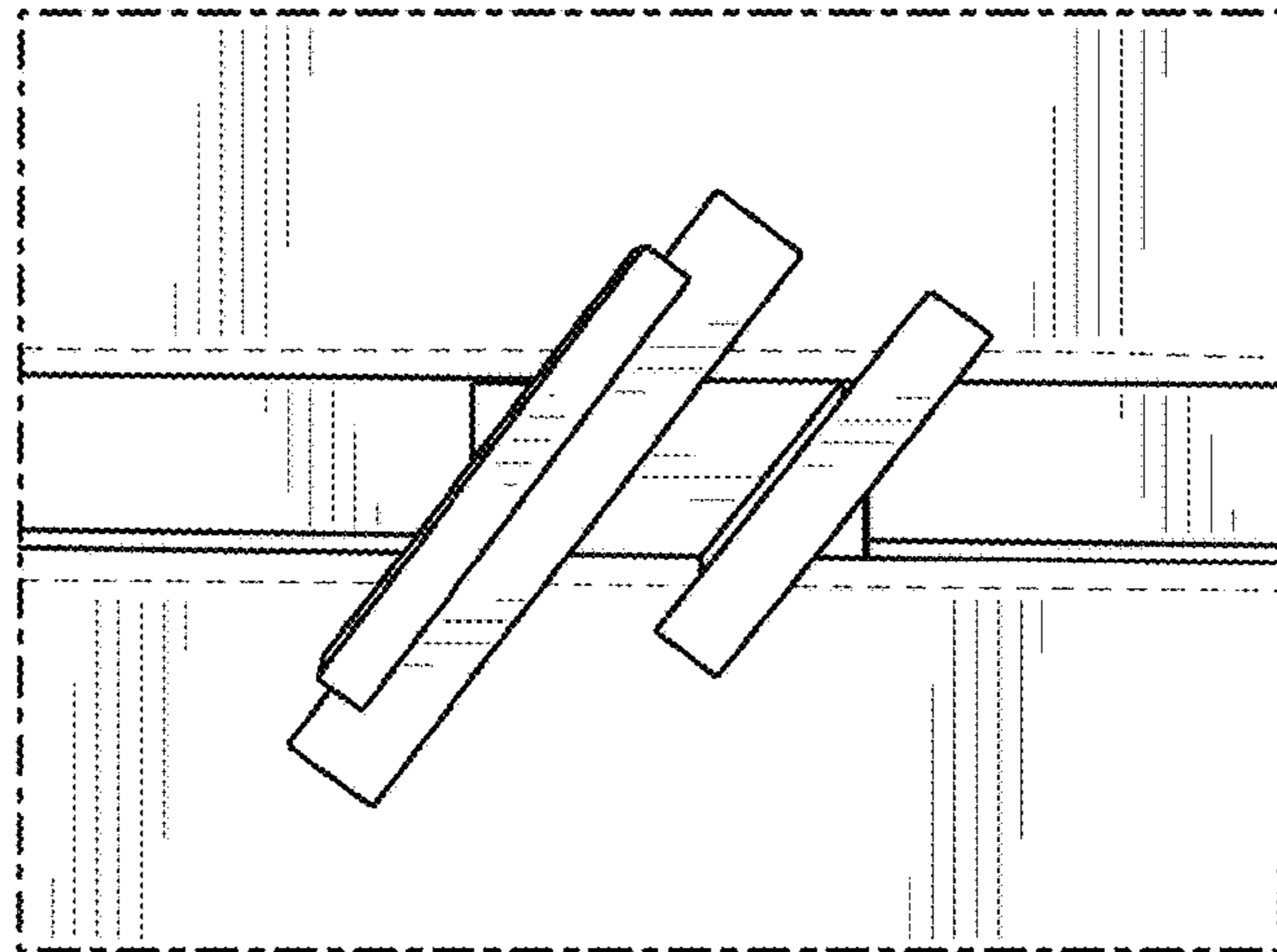

FIG. 1.9

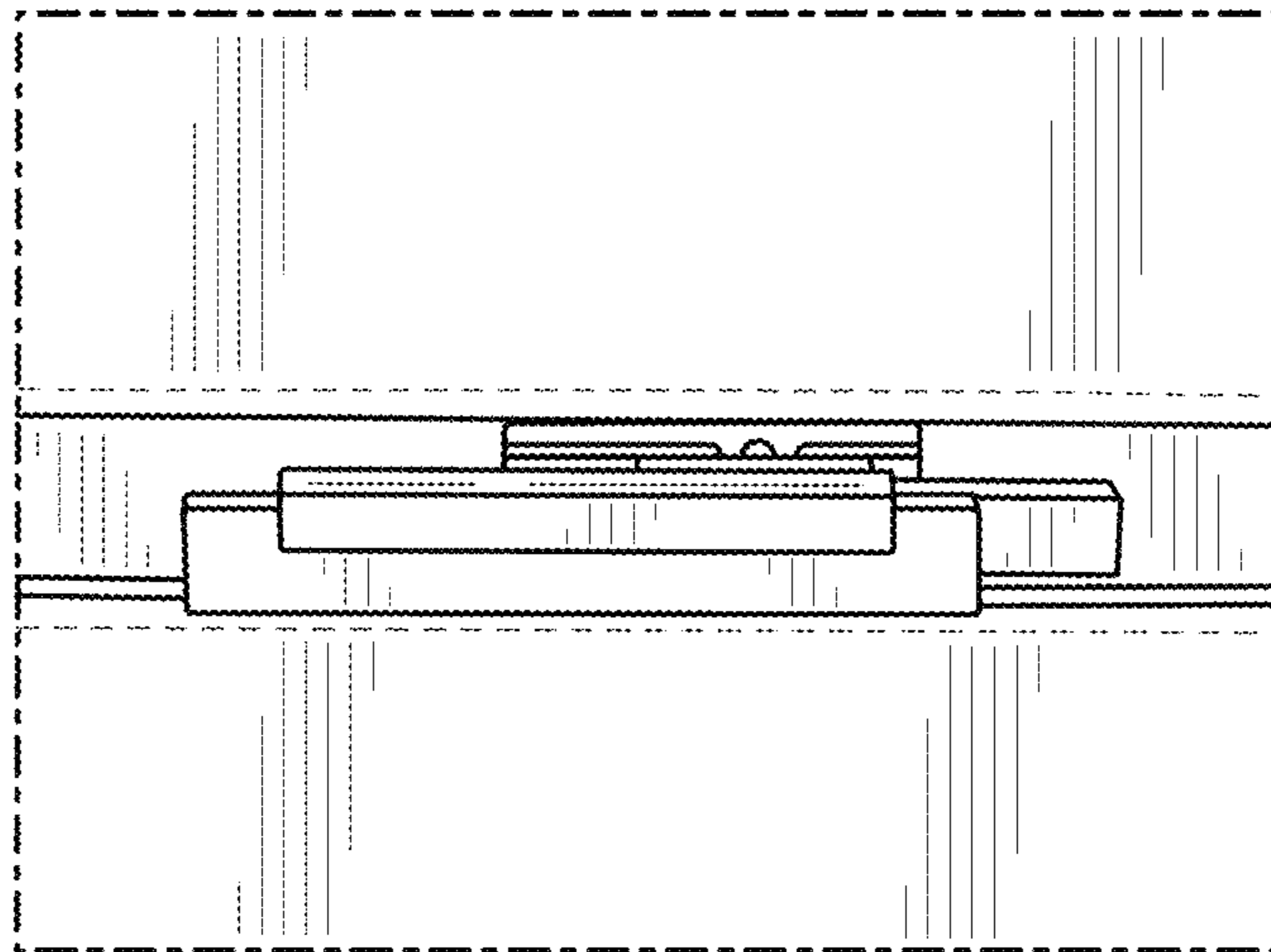

FIG. 1.10