



US00D821638S

(12) **United States Design Patent**  
**Wu**

(10) **Patent No.:** **US D821,638 S**  
(45) **Date of Patent:** **\*\* Jun. 26, 2018**

(54) **VEHICLE LIGHT BEZEL AND BASE**

(71) Applicant: **COPLUS INC.**, Tainan (TW)

(72) Inventor: **Po-Hua Wu**, Tainan (TW)

(73) Assignee: **Coplus Inc.**, Tainan (TW)

(\*\*) Term: **15 Years**

(21) Appl. No.: **29/584,142**

(22) Filed: **Nov. 11, 2016**

(30) **Foreign Application Priority Data**

May 13, 2016 (TW) ..... 105302655

(51) **LOC (11) Cl.** ..... **26-99**

(52) **U.S. Cl.**  
USPC ..... **D26/139**

(58) **Field of Classification Search**  
USPC ..... D26/28-36, 139; 362/80-83, 267-269,  
362/459-468, 475-478, 485-487  
CPC ..... F21S 48/00; F21S 48/10; F21S 48/115;  
F21S 48/225; F21S 48/1233; F21S  
48/1266; F21S 48/1388; F21S 48/2268;  
F21V 21/04; B60Q 9/13; B60Q 9/135;  
B60Q 9/1375

See application file for complete search history.

(56) **References Cited**

U.S. PATENT DOCUMENTS

D425,240 S \* 5/2000 Goeckeritz ..... D26/139  
D676,599 S \* 2/2013 Davidson ..... D26/139

\* cited by examiner

*Primary Examiner* — Marcus Jackson

(74) *Attorney, Agent, or Firm* — Lewis Roca Rothgerber  
Christie LLP

(57) **CLAIM**

The ornamental design for a vehicle light bezel and base, as  
shown and described.

**DESCRIPTION**

FIG. 1 is a front perspective view of the vehicle light bezel  
and base;

FIG. 2 is a rear perspective view thereof;

FIG. 3 is a front view thereof;

FIG. 4 is a rear view thereof;

FIG. 5 is a left side view thereof;

FIG. 6 is a right side view thereof;

FIG. 7 is a top view thereof; and,

FIG. 8 is a bottom view thereof.

The broken lines in the drawings are for illustrative purpose  
only and form no part of the claimed design.

**1 Claim, 5 Drawing Sheets**

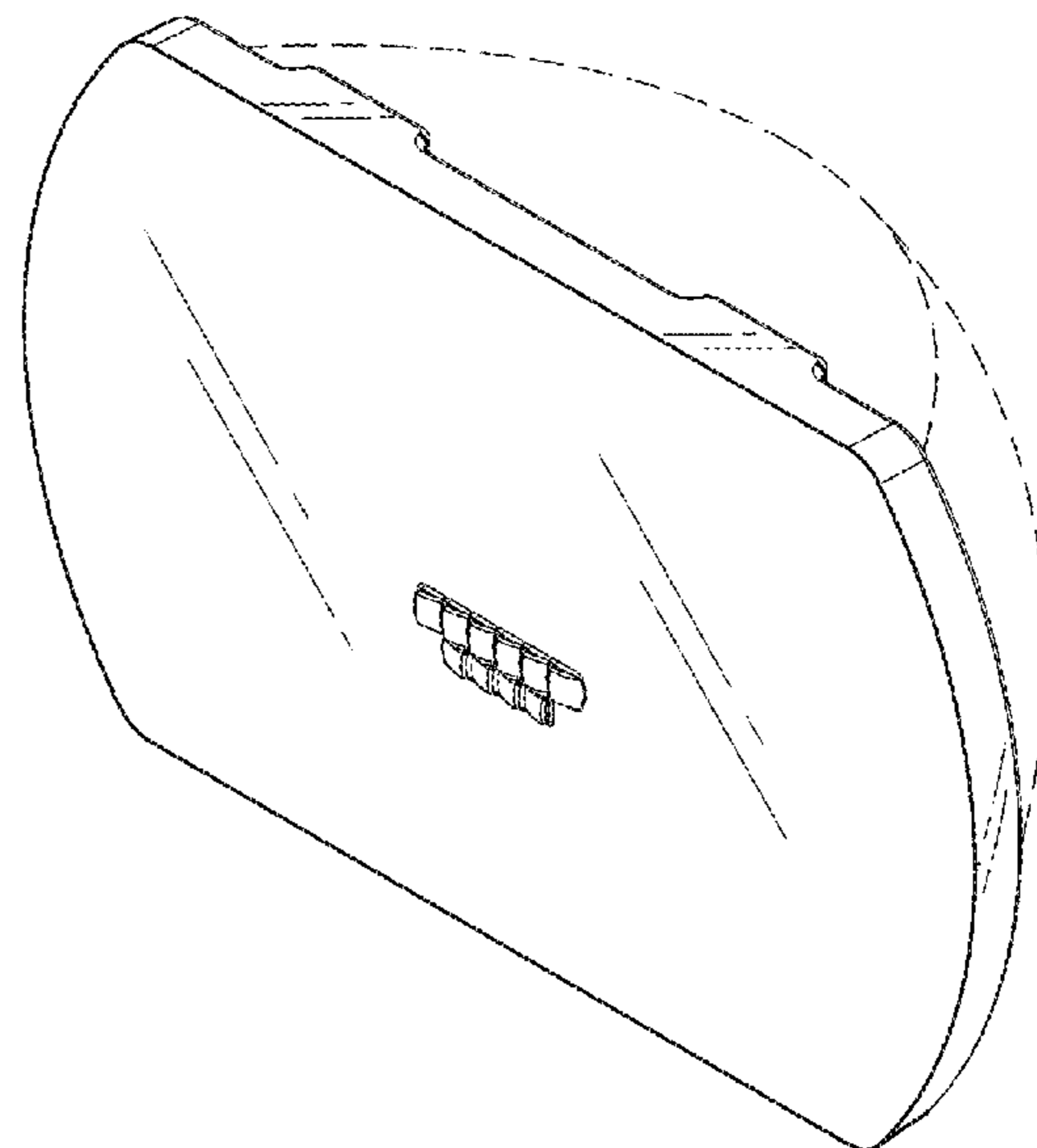
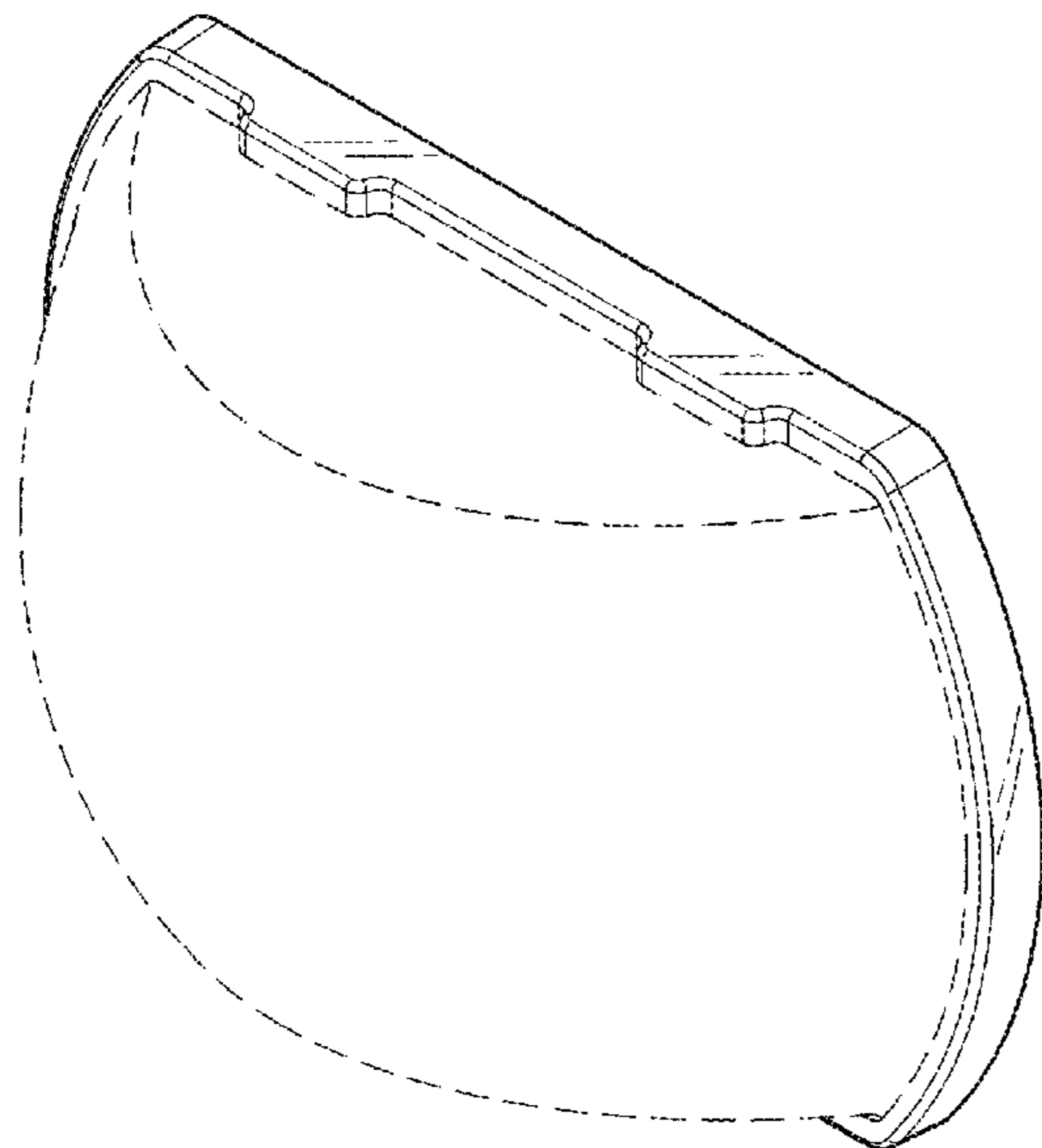

FIG. 1

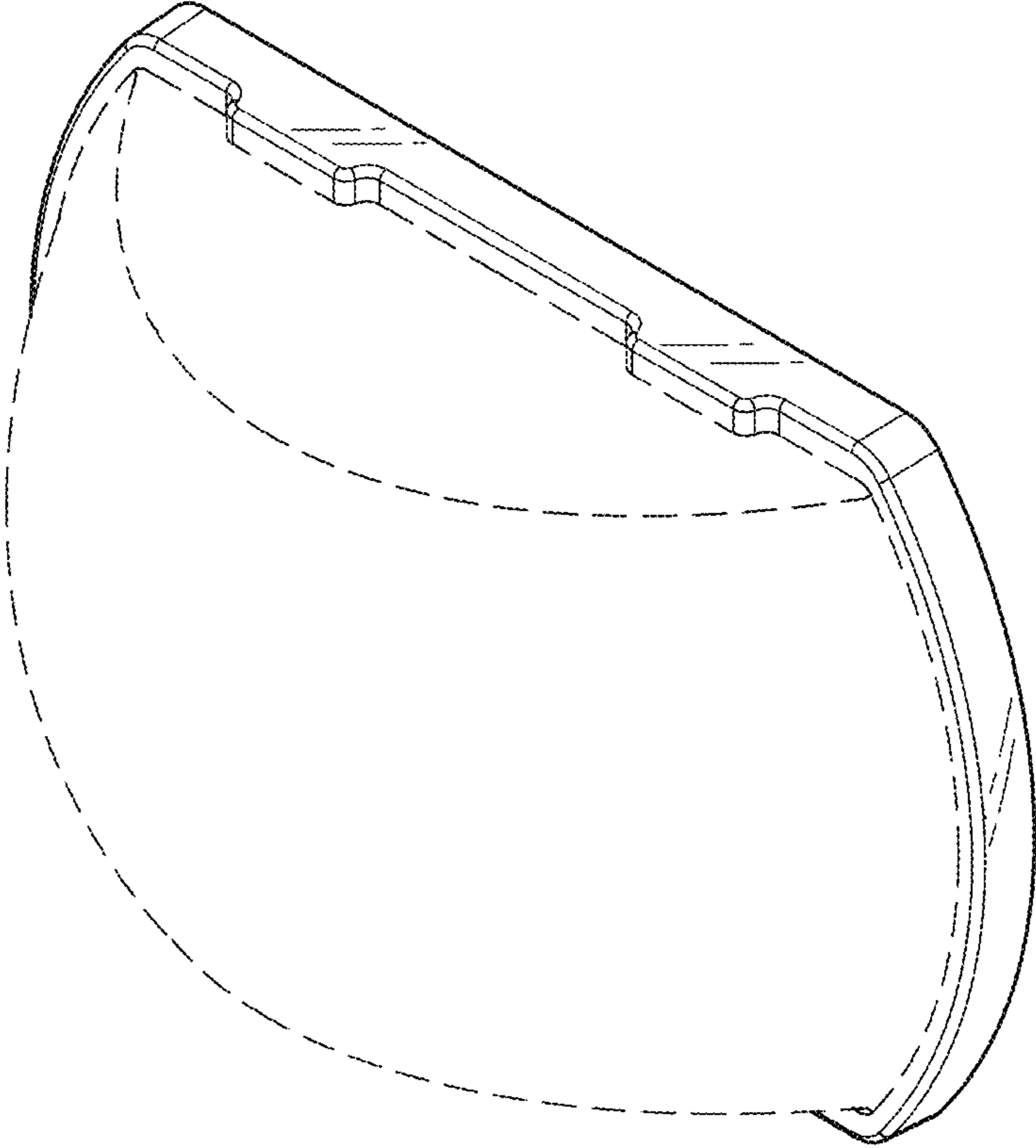
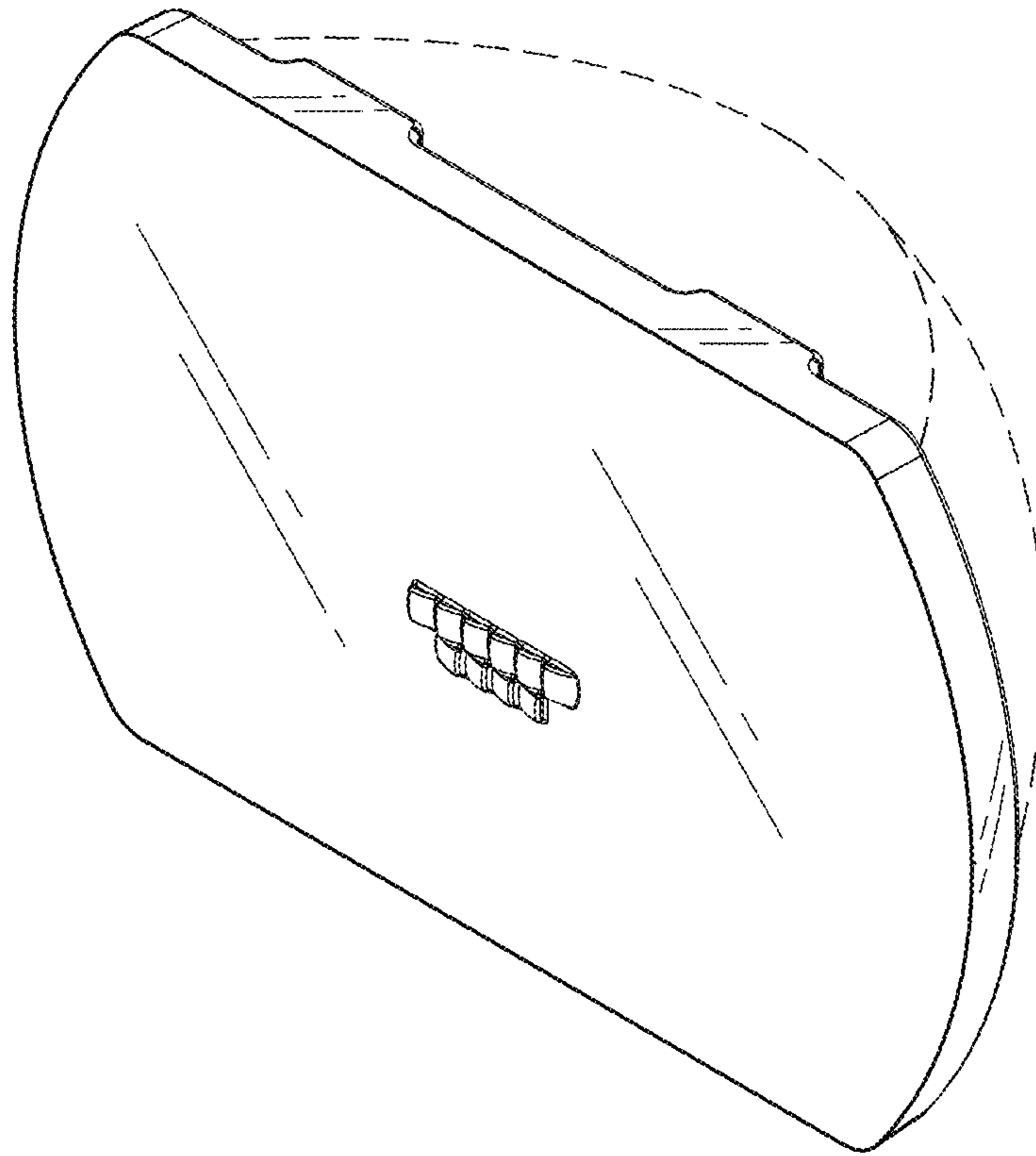

FIG. 2



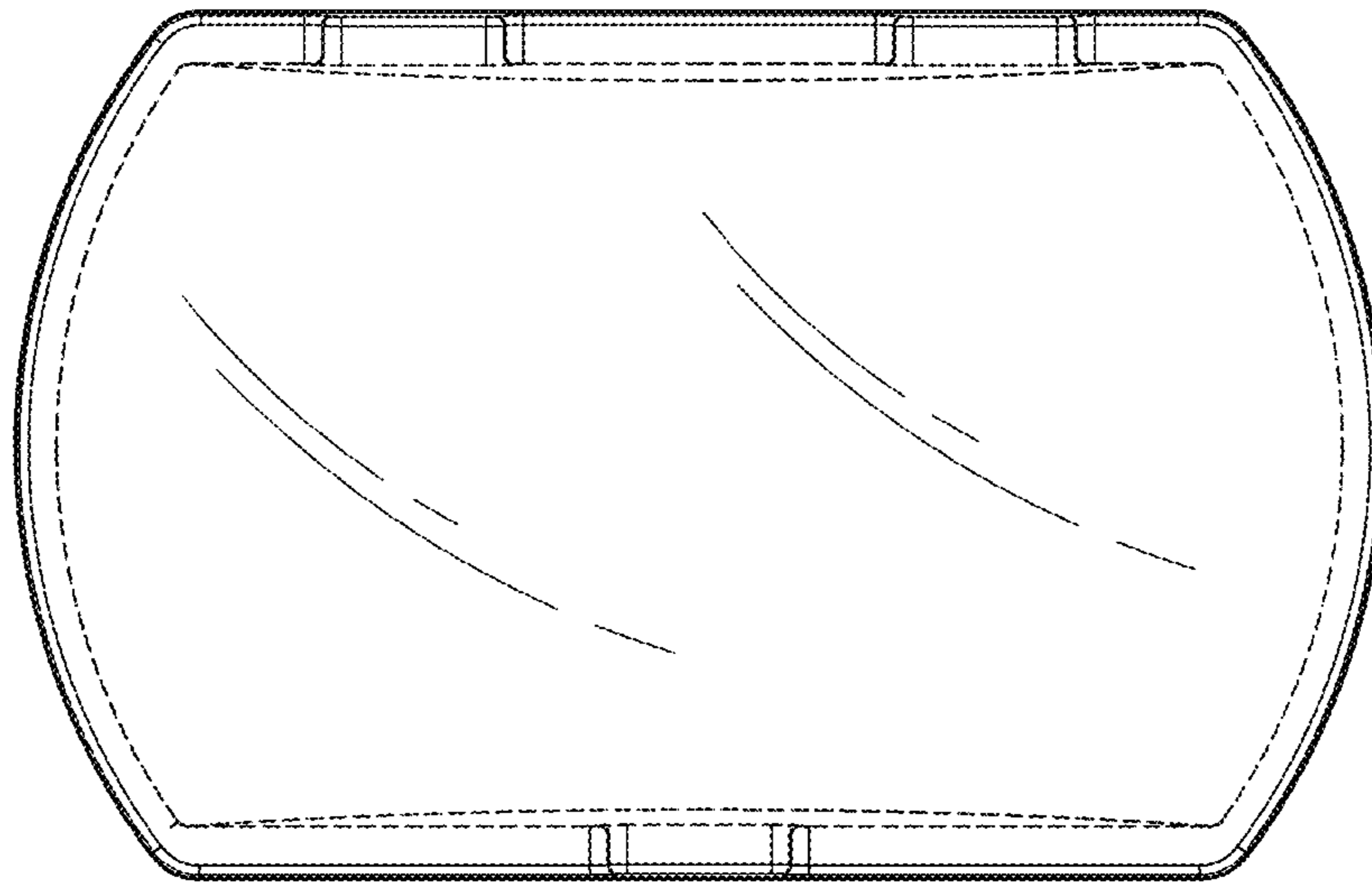
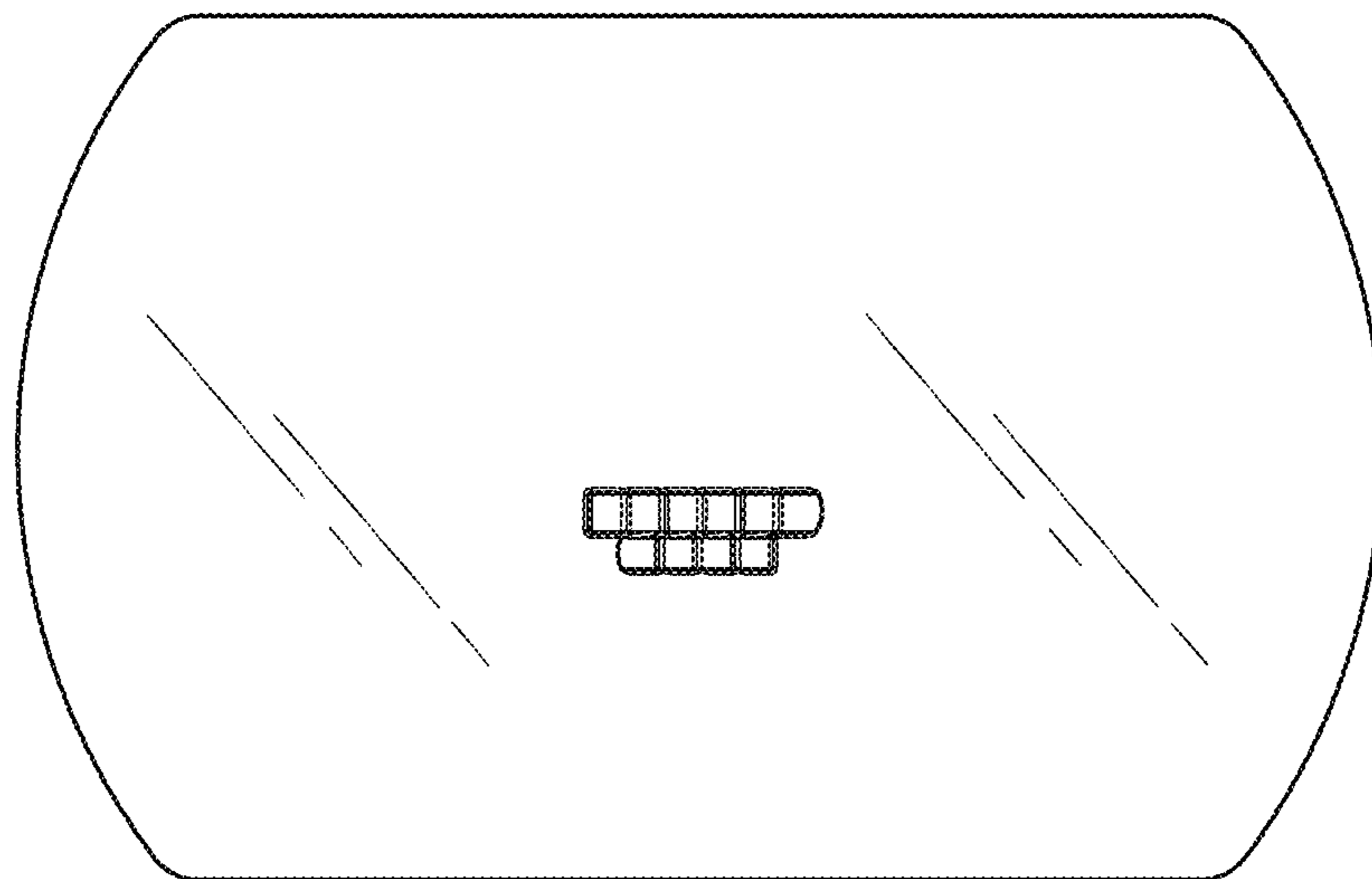

FIG. 3

FIG. 4



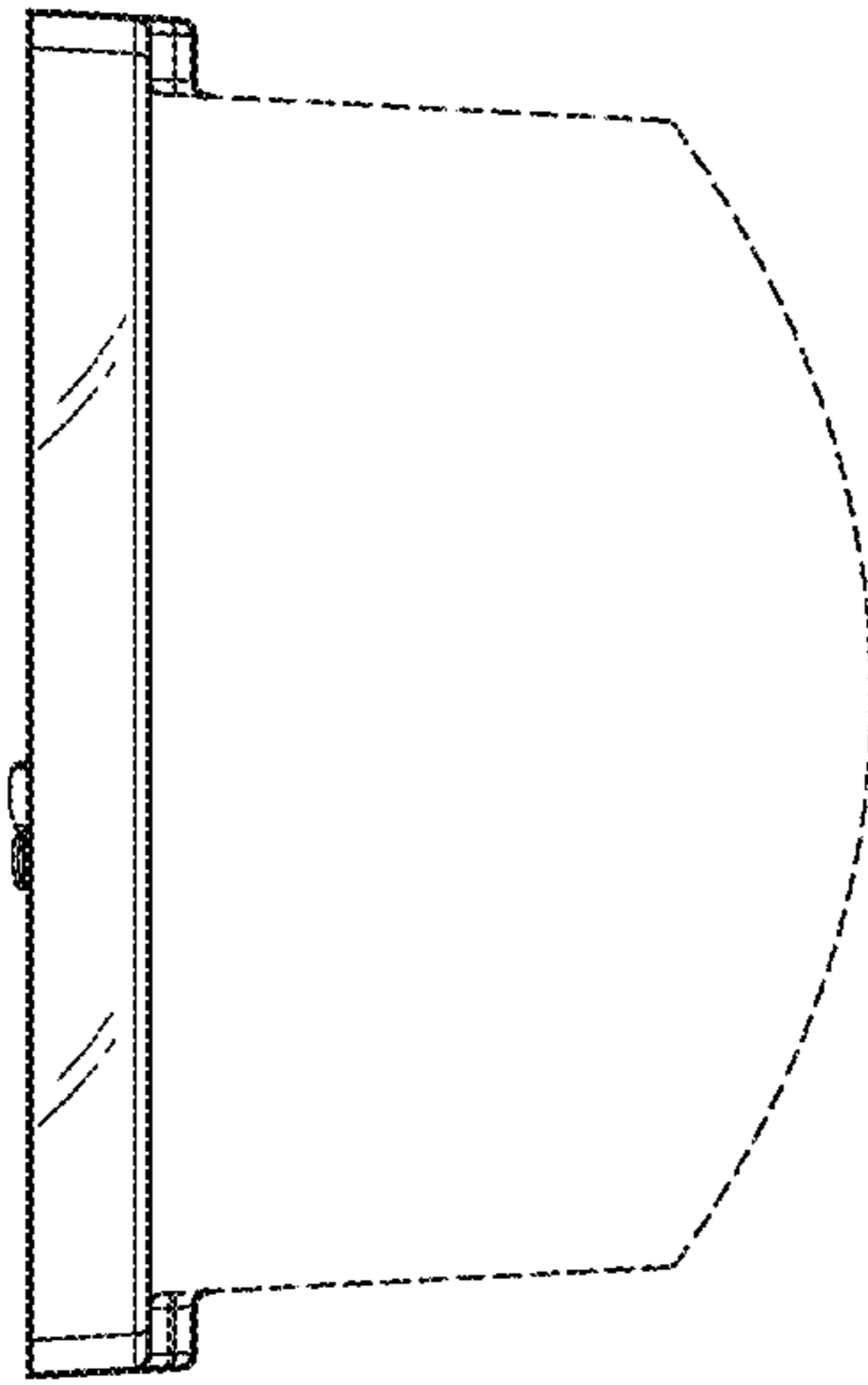
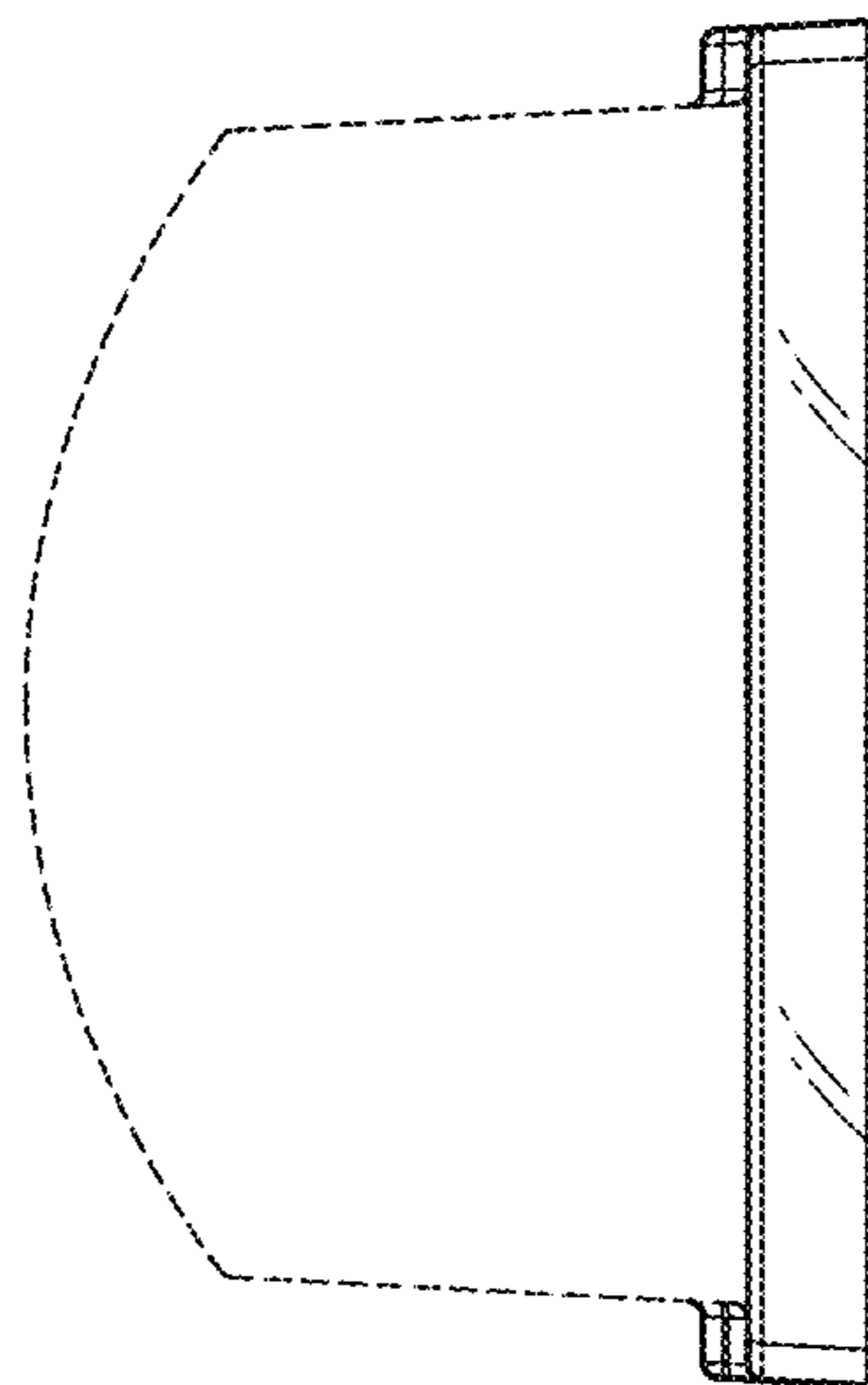

FIG. 5

FIG. 6



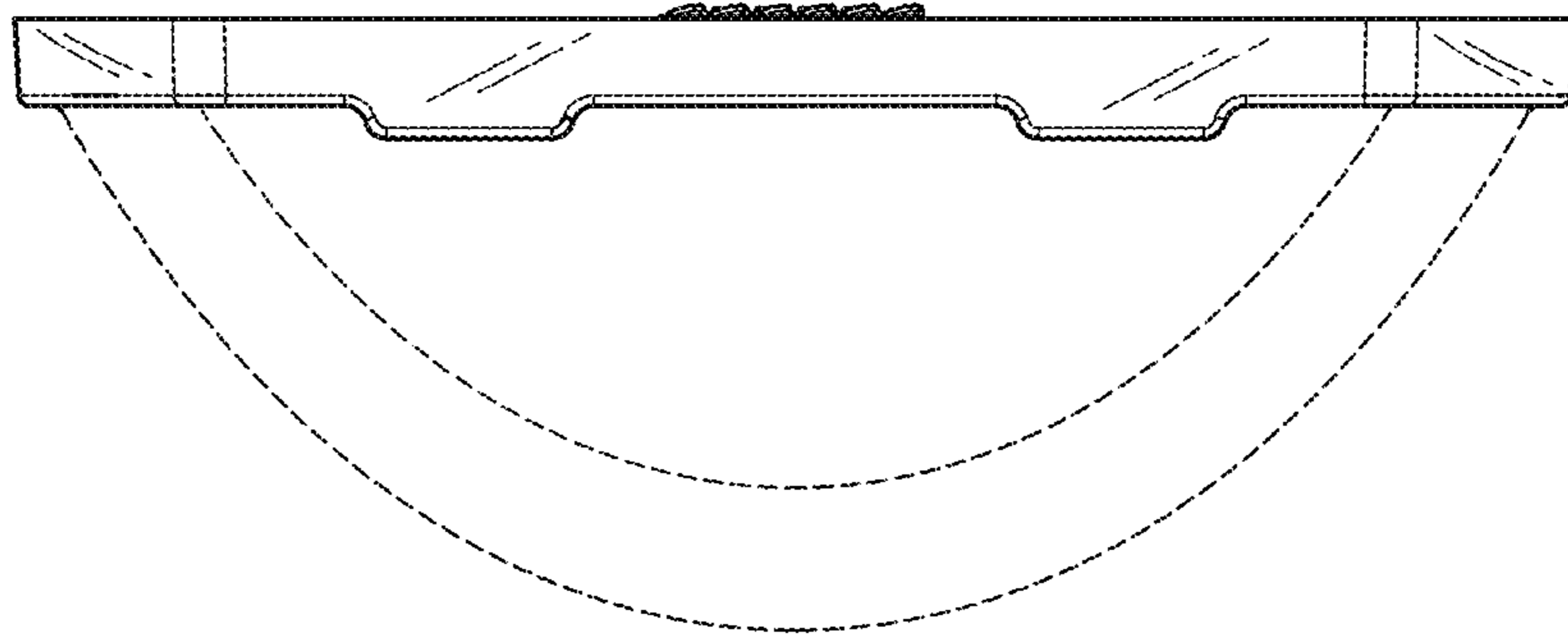

FIG. 7

FIG. 8

