



US00D821537S

(12) **United States Design Patent** (10) **Patent No.:** **US D821,537 S**  
**Ye** (45) **Date of Patent:** **\*\* Jun. 26, 2018**

(54) **MOSQUITO ZAPPER BULB** 2,674,682 A \* 4/1954 Hanson ..... A01M 1/04  
43/112

(71) Applicant: **THE NEW GENIUS (SZ)** 4,490,937 A \* 1/1985 Yavnieli ..... A01M 1/04  
**TECHNOLOGY CO., LIMITED,** 43/112  
Shenzhen, Guangdong (CN) 4,873,786 A \* 10/1989 Franco ..... A01M 1/04  
43/113

(72) Inventor: **Jianrong Ye, Guangdong (CN)** D558,852 S \* 1/2008 Chen ..... D22/123  
D569,475 S \* 5/2008 Szymanski ..... D22/123  
D583,008 S \* 12/2008 Vranesh ..... D22/123

(73) Assignee: **THE NEW GENIUS (SZ)** \* cited by examiner  
**TECHNOLOGY CO., LIMITED,**  
Shenzhen (CN)

(\*\*) Term: **15 Years**

(21) Appl. No.: **29/600,659**

(22) Filed: **Apr. 13, 2017**

(51) **LOC (11) Cl.** ..... **22-06**

(52) **U.S. Cl.**  
USPC ..... **D22/123**

(58) **Field of Classification Search**  
USPC ..... D22/119–124; 43/112–113  
CPC ... A01M 1/04; A01M 1/223; A01M 2200/012  
See application file for complete search history.

(56) **References Cited**

**U.S. PATENT DOCUMENTS**

1,985,921 A \* 1/1935 Felmer ..... A01M 1/04  
43/112

2,061,458 A \* 11/1936 Folmer ..... A01M 1/04  
43/112

2,475,182 A \* 7/1949 Gardenhour ..... A01M 1/04  
43/112

*Primary Examiner* — Catherine R Oliver-Garcia

(57) **CLAIM**

The ornamental design for a mosquito zapper bulb, as shown and described.

**DESCRIPTION**

FIG. 1 is a first perspective view of a mosquito zapper bulb showing my new design;  
FIG. 2 is a second perspective view thereof;  
FIG. 3 is a front elevational view thereof;  
FIG. 4 is a rear elevational view thereof;  
FIG. 5 is a left side view thereof;  
FIG. 6 is a right side view thereof;  
FIG. 7 is a top plan view thereof; and,  
FIG. 8 is a bottom plan view thereof.  
The broken lines in the drawings illustrate portions of the mosquito zapper bulb which form no part of the claimed design.

**1 Claim, 8 Drawing Sheets**

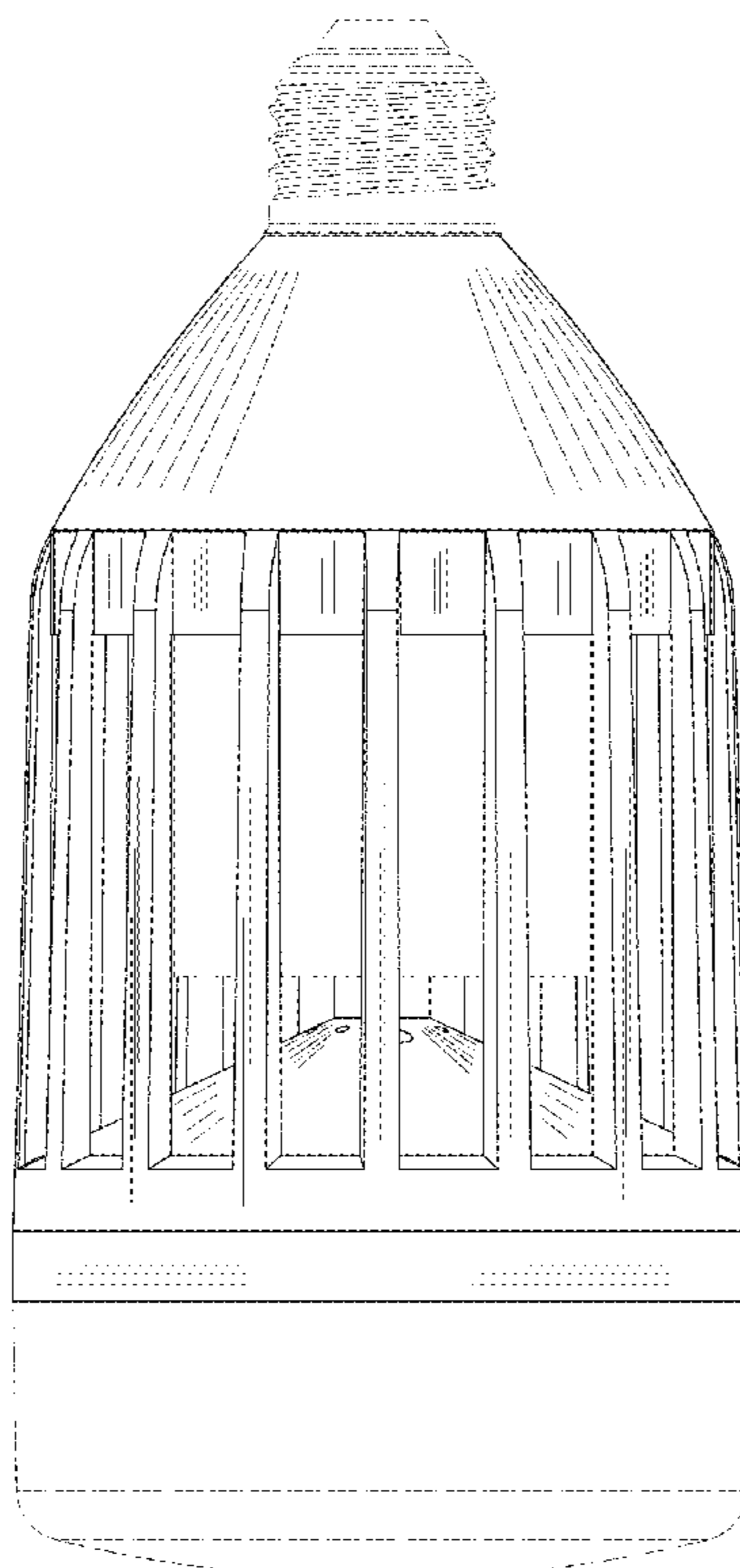

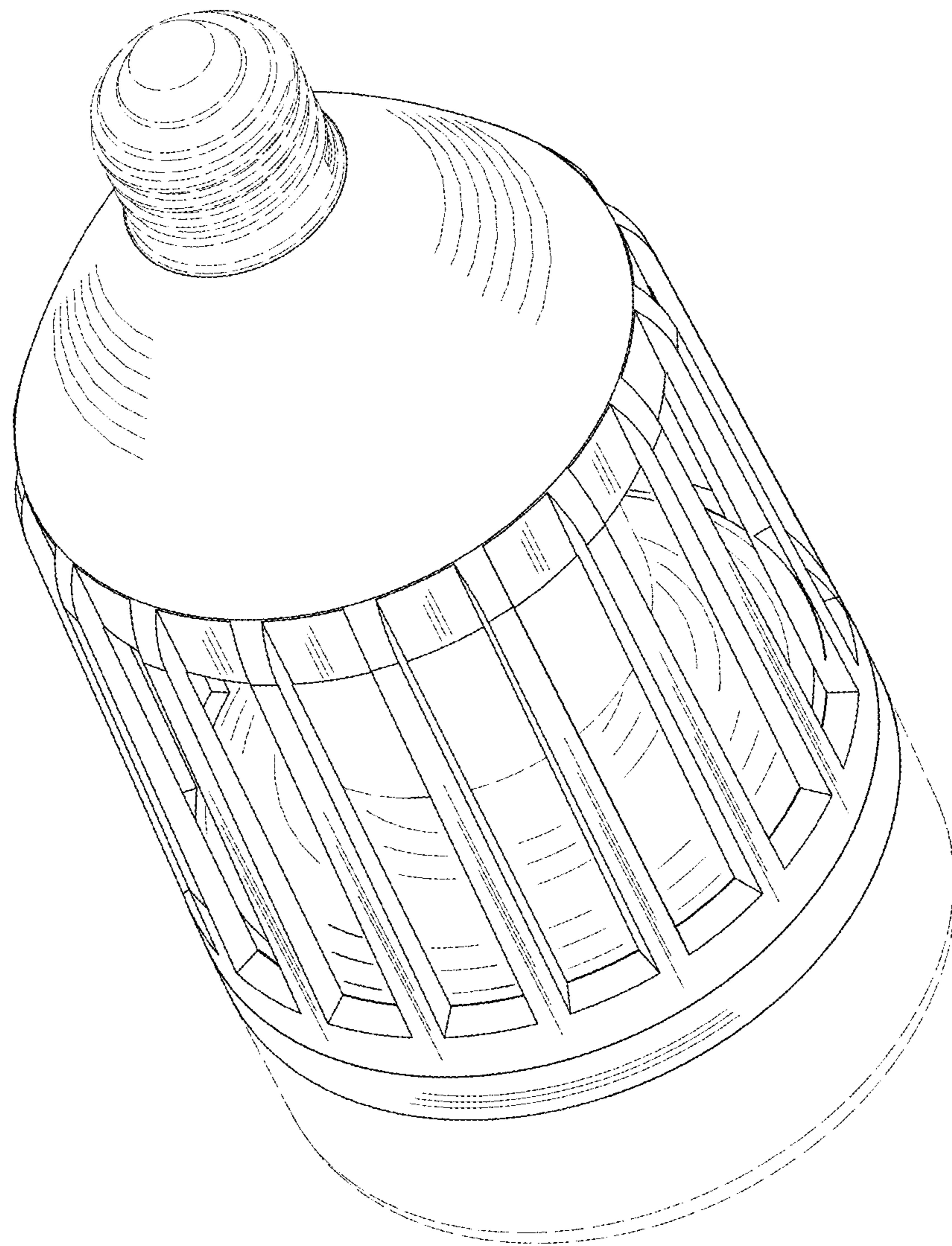

FIG.1

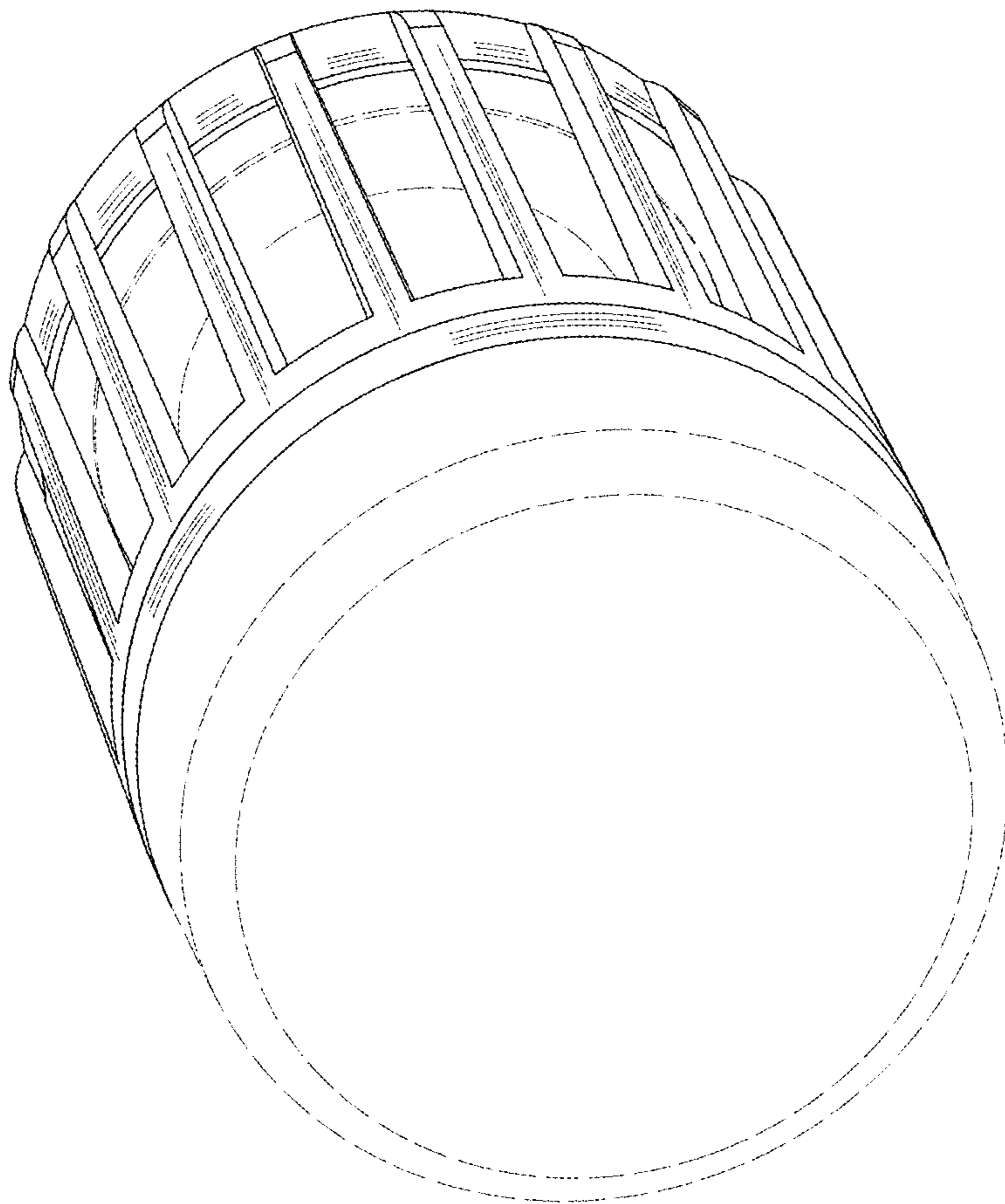

FIG.2

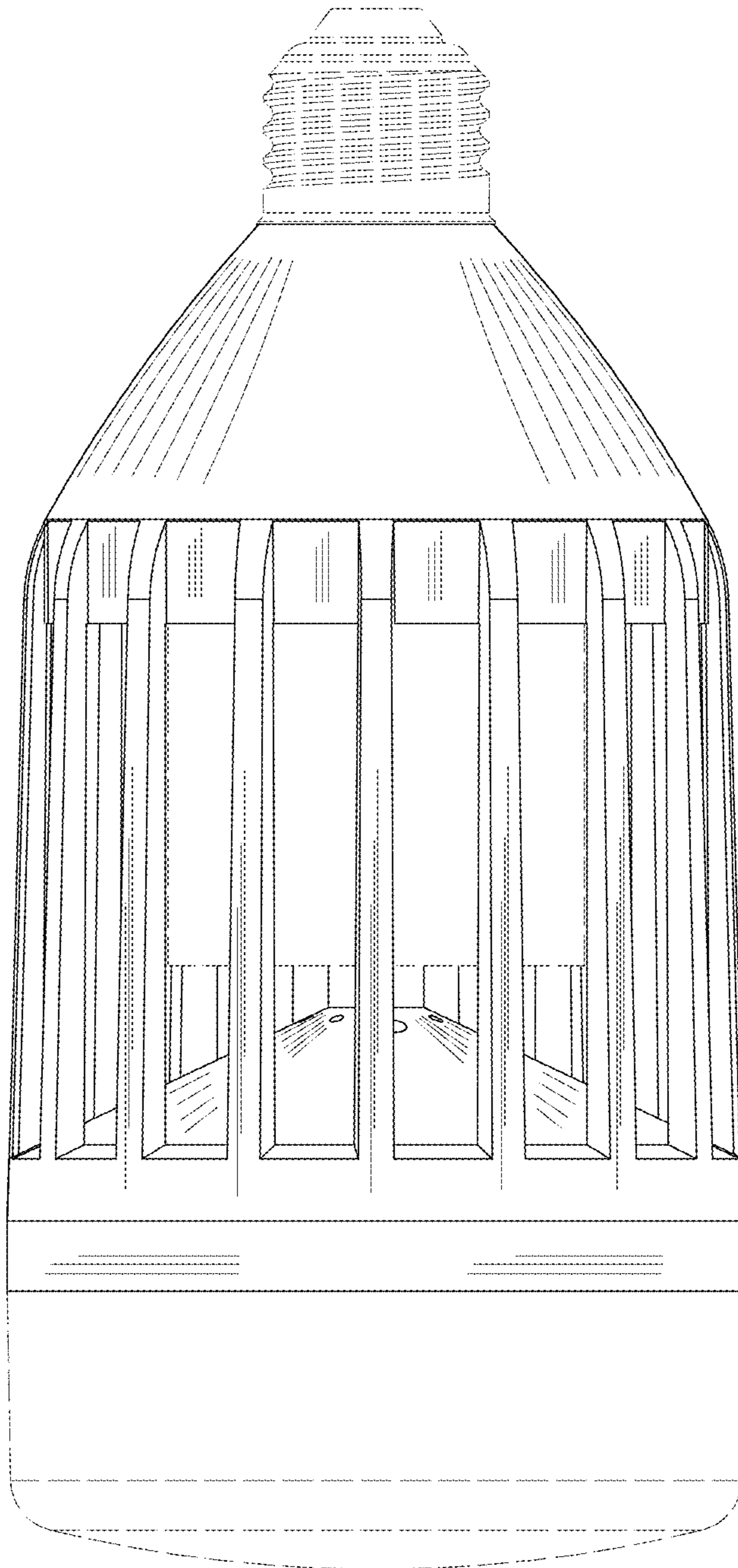

FIG.3



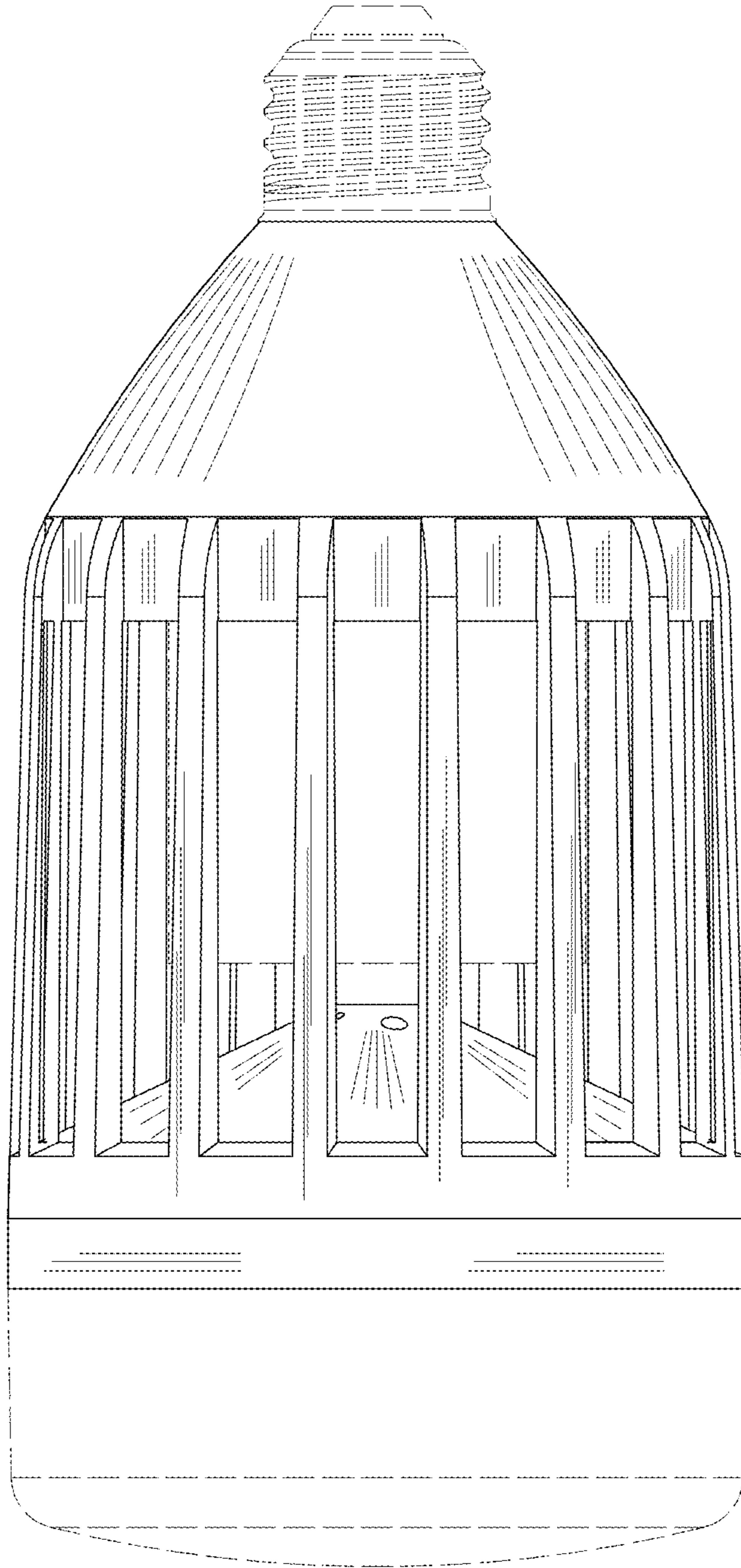

FIG.4

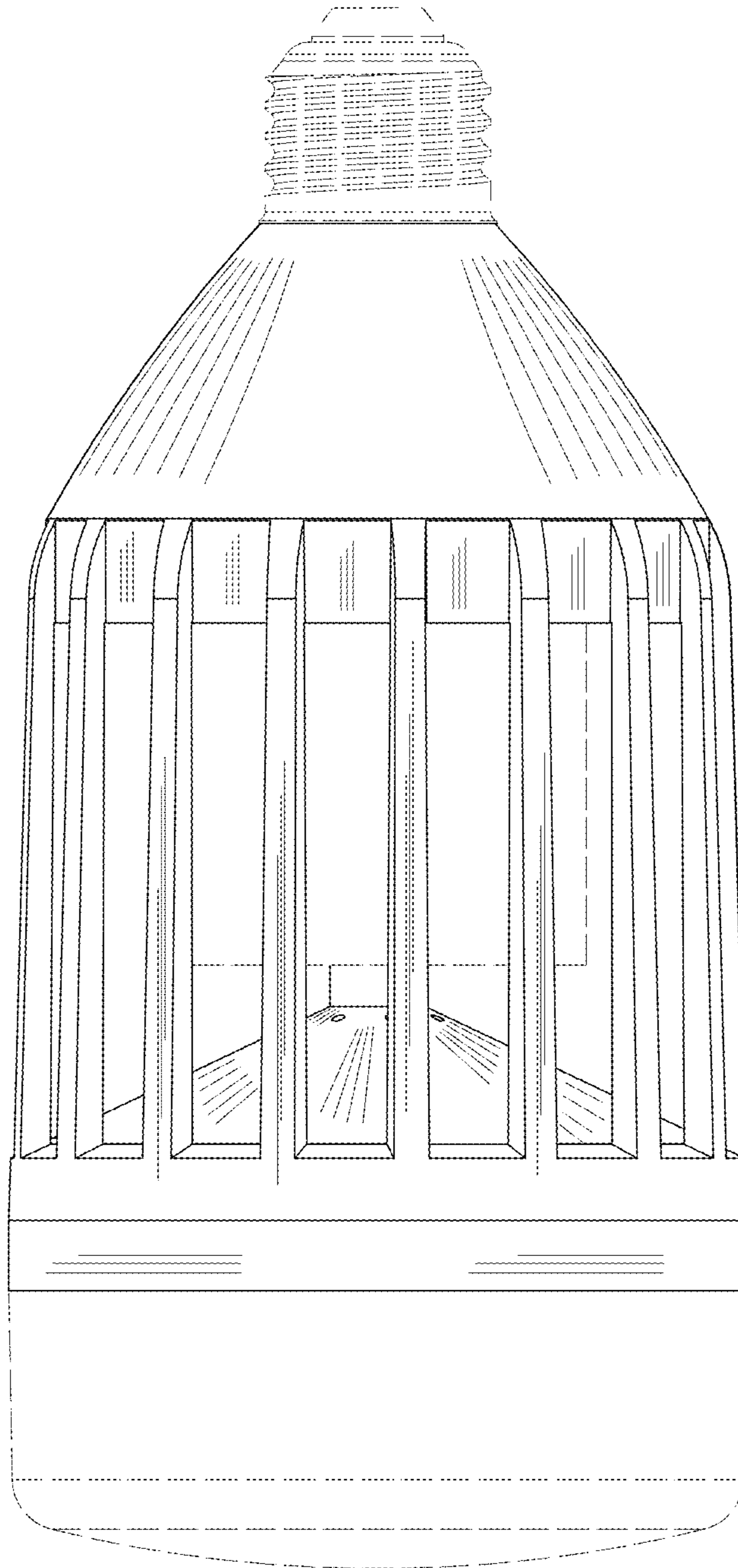

FIG.5

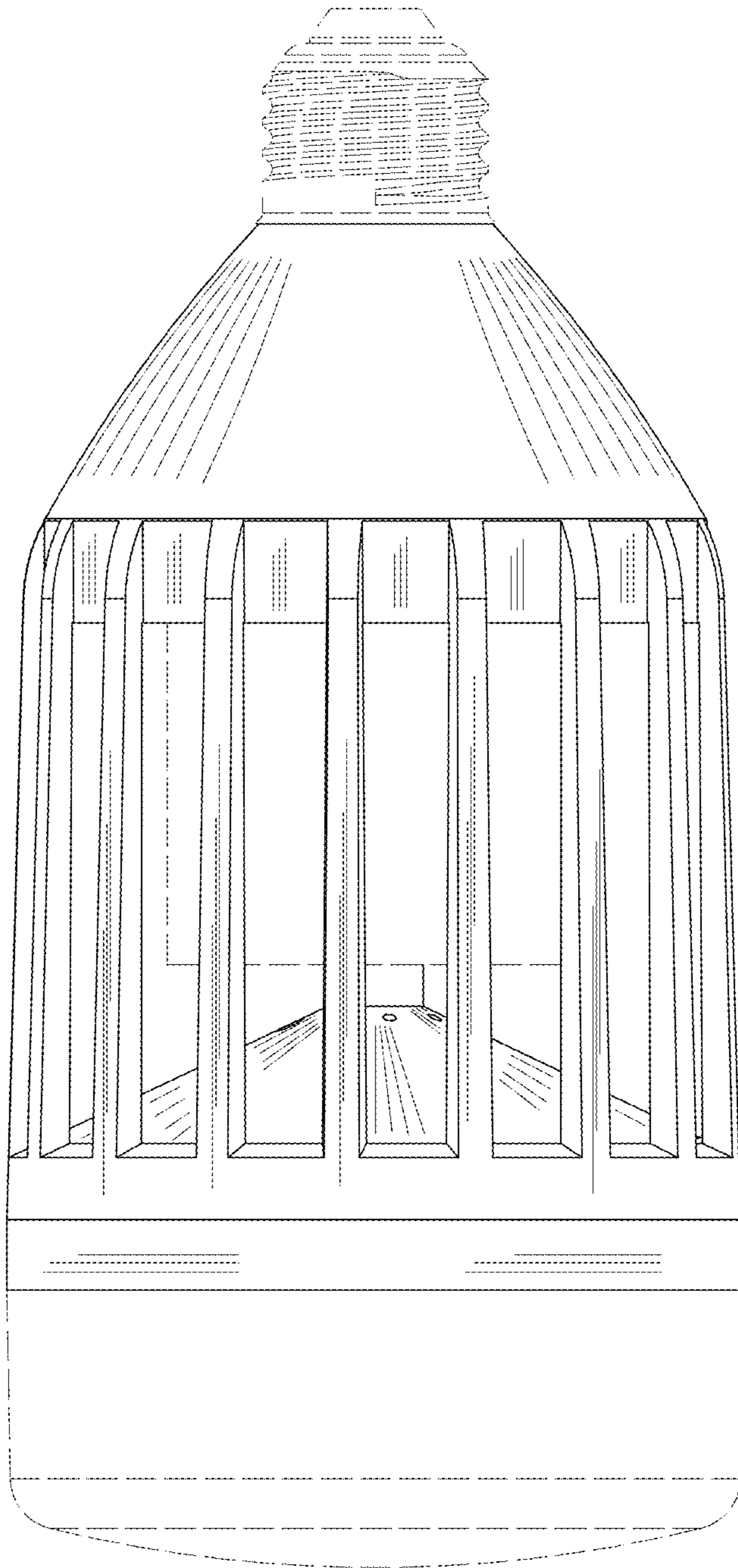

FIG.6

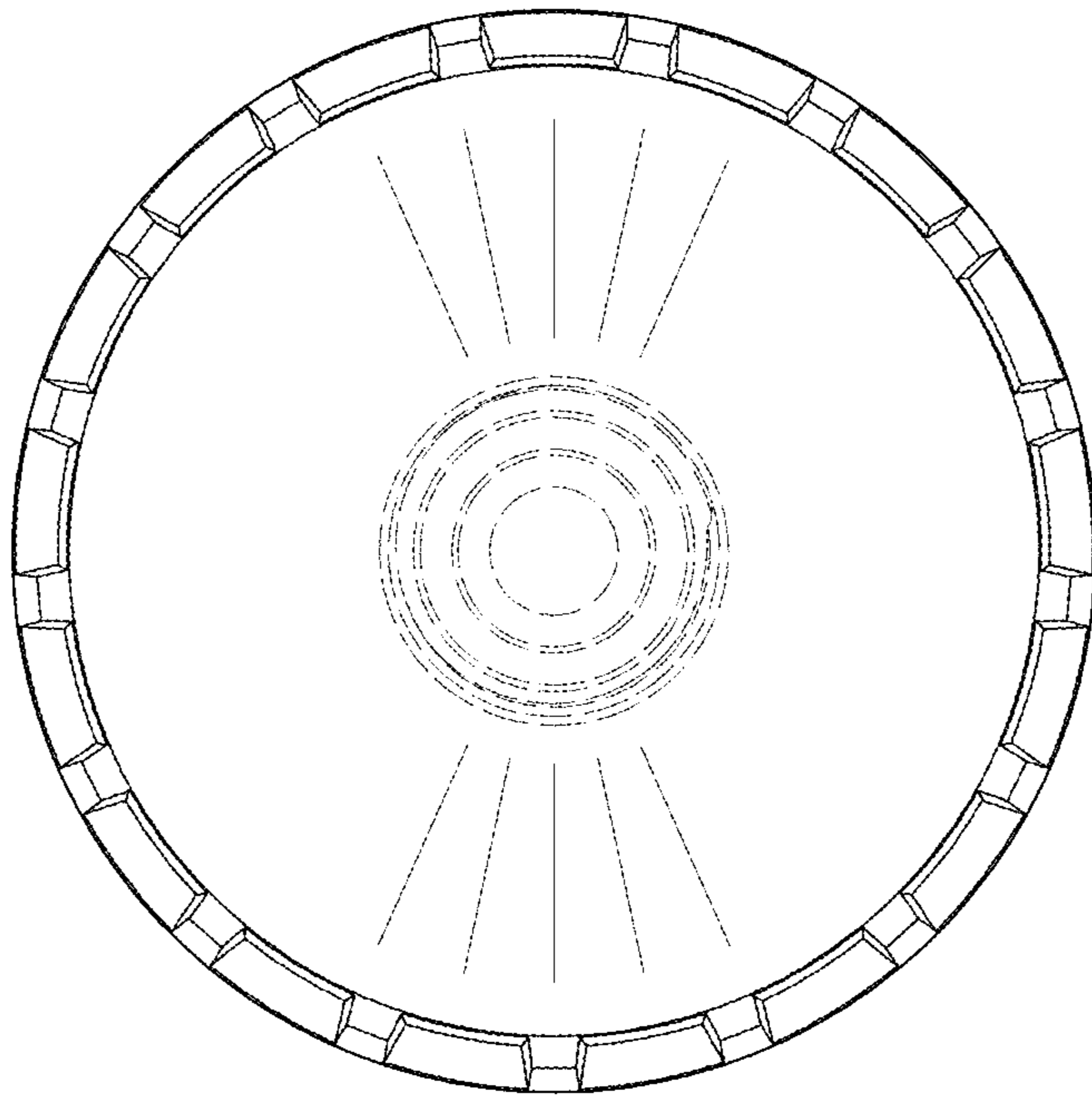

FIG.7



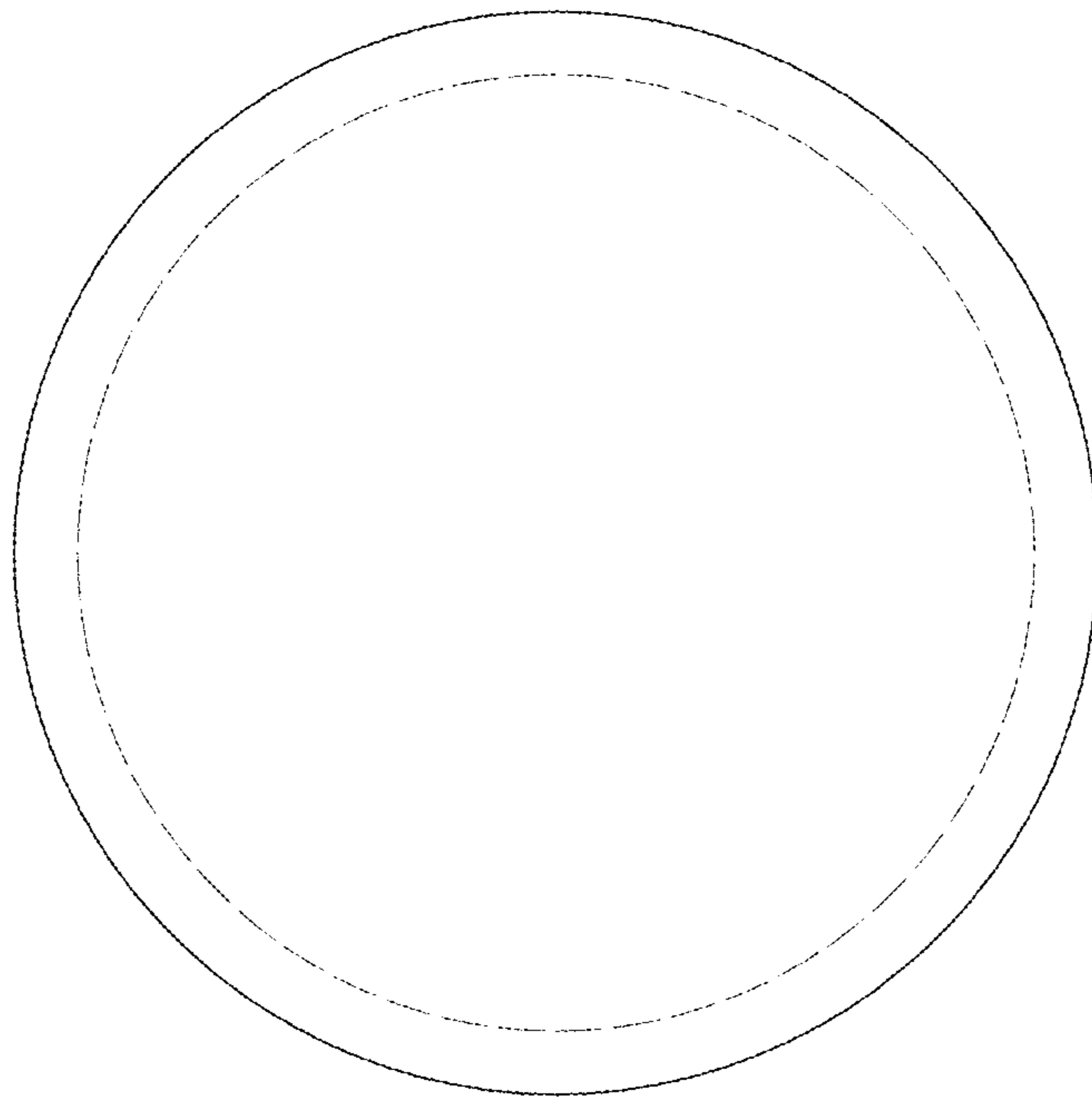

FIG.8