



US00D821528S

(12) **United States Design Patent**
Doty

(10) **Patent No.:** **US D821,528 S**
(45) **Date of Patent:** **** Jun. 26, 2018**

- (54) **FIREARM MAGAZINE CARRIER**
- (71) Applicant: **Douglas H. Doty**, Homosassa, FL (US)
- (72) Inventor: **Douglas H. Doty**, Homosassa, FL (US)
- (**) Term: **15 Years**
- (21) Appl. No.: **29/574,439**
- (22) Filed: **Aug. 15, 2016**
- (51) **LOC (11) Cl.** **22-01**
- (52) **U.S. Cl.**
USPC **D22/108**
- (58) **Field of Classification Search**
USPC D22/108
CPC F41A 9/70; F41A 9/65; F41A 9/71; F41A 9/68; F41A 9/69; F41A 11/02; F41A 9/61; F41A 9/00; F41A 9/17; F41A 9/23; F41A 9/34; F41A 9/84
See application file for complete search history.

(56) **References Cited**

U.S. PATENT DOCUMENTS

- 5,682,981 A 11/1997 Sudborough
- 6,196,382 B1 3/2001 Lenderman
- 6,212,815 B1 * 4/2001 Fitzpatrick F41A 9/65
224/196
- D593,634 S * 6/2009 Fitzpatrick D22/108
- D642,647 S * 8/2011 Fitzpatrick D22/108

(Continued)

Primary Examiner — Michael A. Pratt

(74) *Attorney, Agent, or Firm* — Law Office of Steven R. Olsen, PLLC; Steven R. Olsen

(57) **CLAIM**

The ornamental design for a firearm magazine carrier, as shown and described.

DESCRIPTION

FIGS. 1 and 2 are perspective views of my new design for a firearm magazine carrier according to a first embodiment of my design;

FIGS. 3 and 4 are perspective views of my new design for a firearm magazine carrier according to a second embodiment of my design;

FIGS. 5 and 6 are perspective views of my new design for a firearm magazine carrier according to a third embodiment of my design;

FIGS. 7 and 8 are perspective views of my new design for a firearm magazine carrier according to a fourth embodiment of my design;

FIG. 9 is a front elevation view of the first embodiment of my new design;

FIG. 10 is a rear elevation view of the first embodiment of my new design;

FIG. 11 is a front elevation view of the second embodiment of my new design;

FIG. 12 is a rear elevation view of the second embodiment of my new design;

FIG. 13 is a front elevation view of the third embodiment of my new design;

FIG. 14 is a rear elevation view of the third embodiment of my new design;

FIG. 15 is a front elevation view of the fourth embodiment of my new design;

FIG. 16 is a rear elevation view of the fourth embodiment of my new design;

FIG. 17 is a first side view of the first, second, third, and fourth embodiments of my new design;

FIG. 18 is a second side view of the first, second, third, and fourth embodiments of my new design;

FIG. 19 is a top view of the first and third embodiments of my new design;

FIG. 20 is a top view of the second and fourth embodiments of my new design; and,

FIG. 21 is a bottom view of the first, second, third, and fourth embodiments of my new design.

The magazine shown in broken lines is for illustrative purposes only and forms no part of the claimed design.

1 Claim, 7 Drawing Sheets

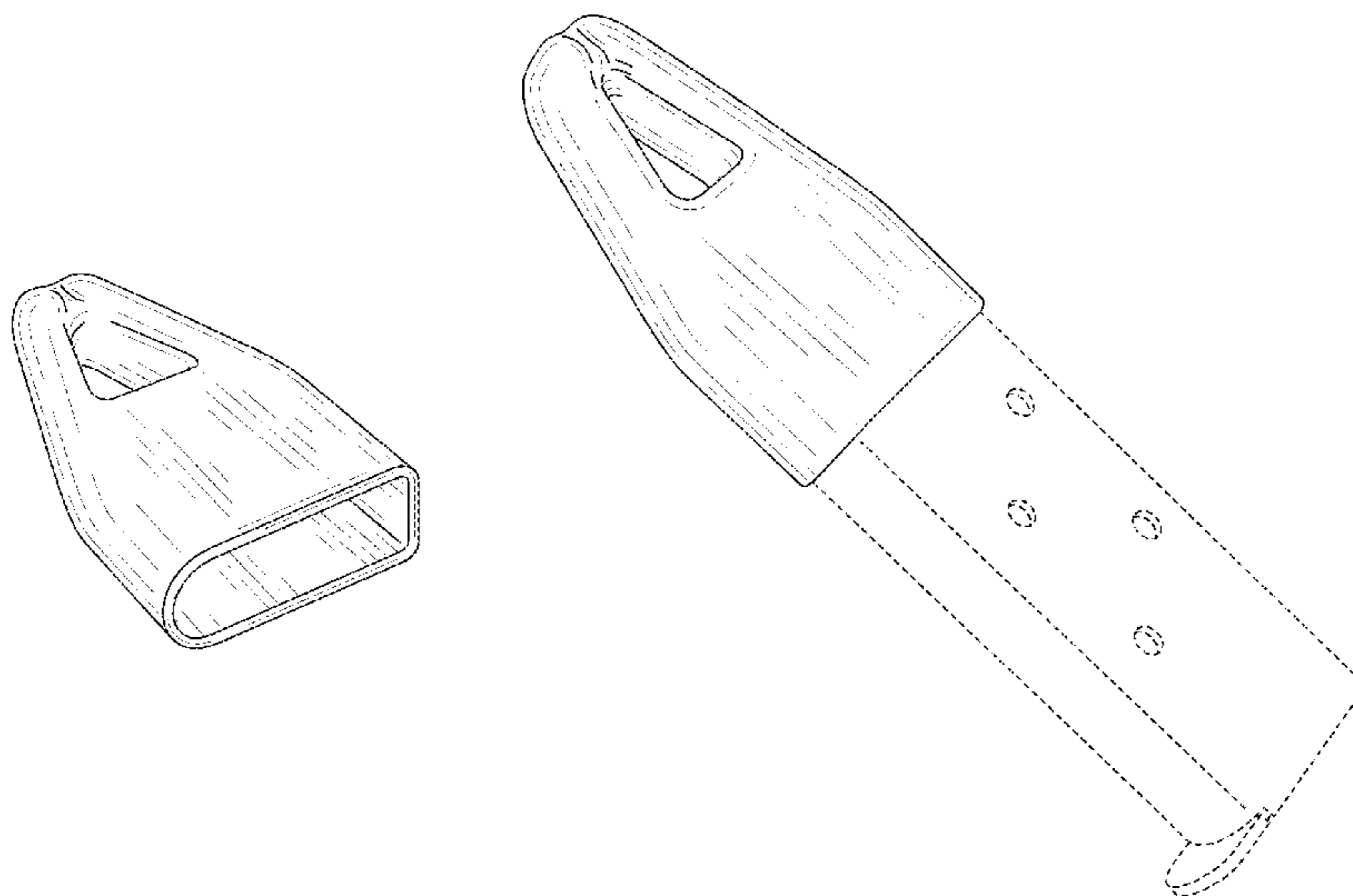

(56)

References Cited

U.S. PATENT DOCUMENTS

D706,895 S * 6/2014 Zayatz D22/108
D767,705 S * 9/2016 Freed D22/108

* cited by examiner

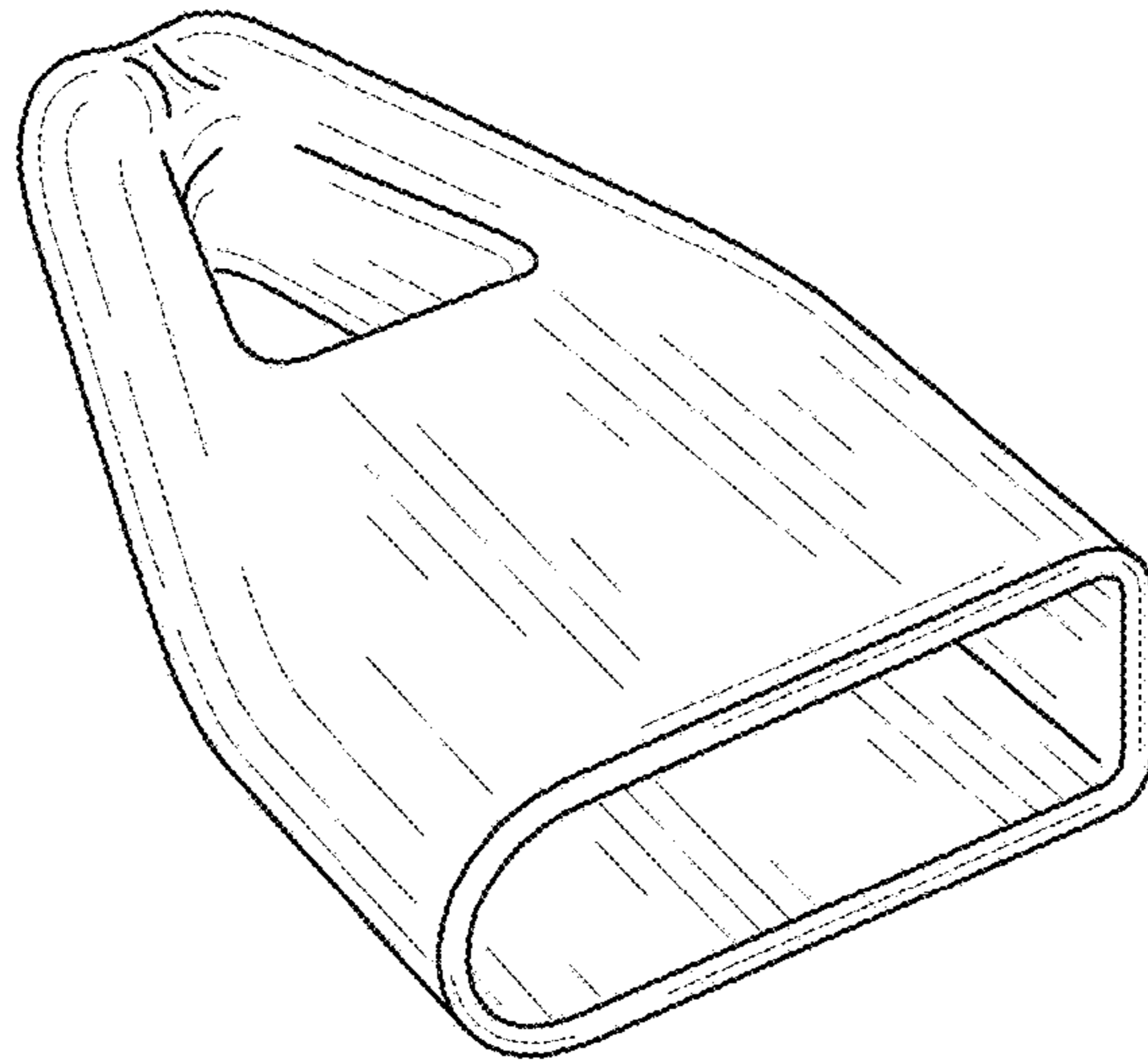

FIG. 1

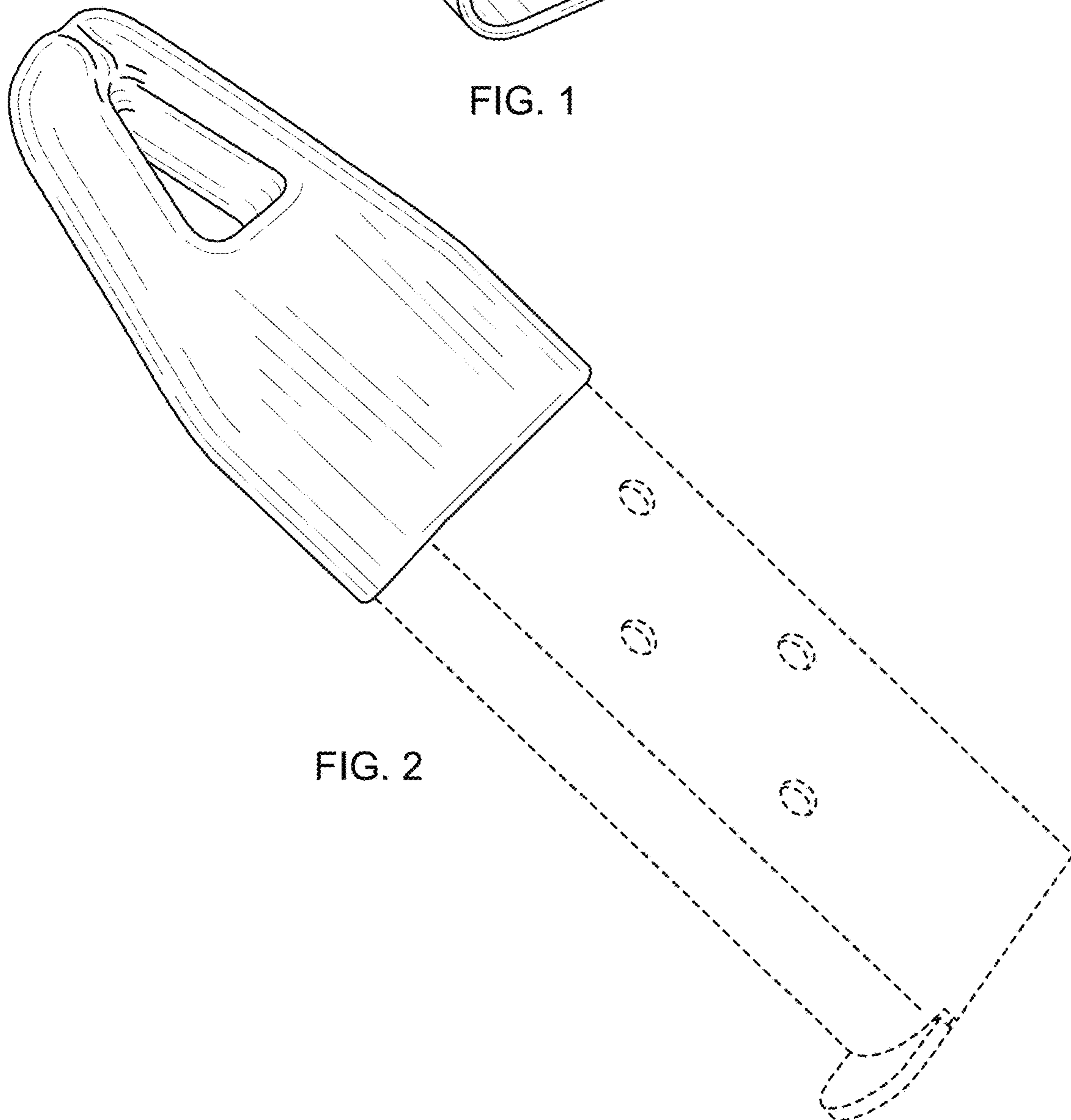

FIG. 2

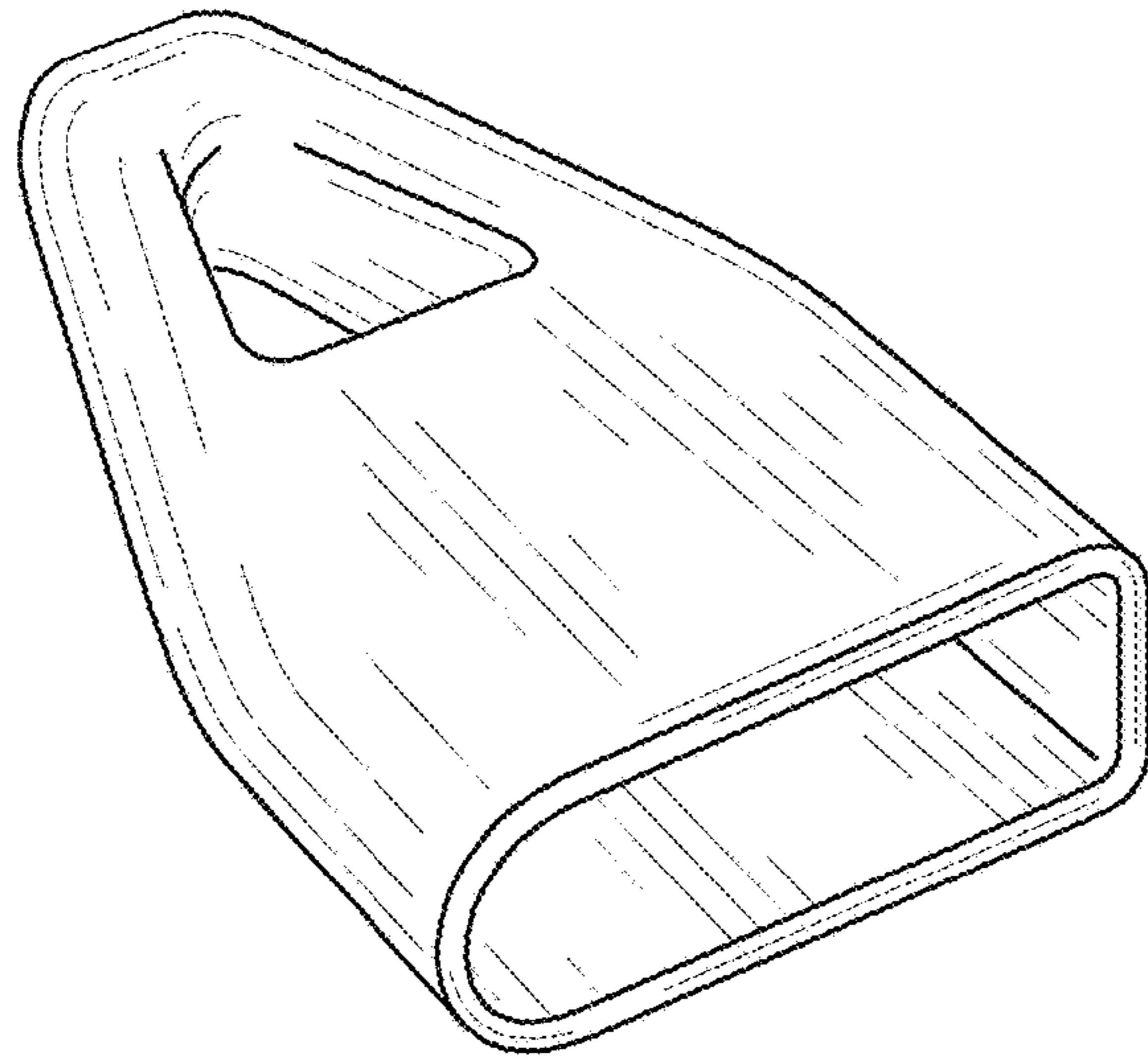

FIG. 3

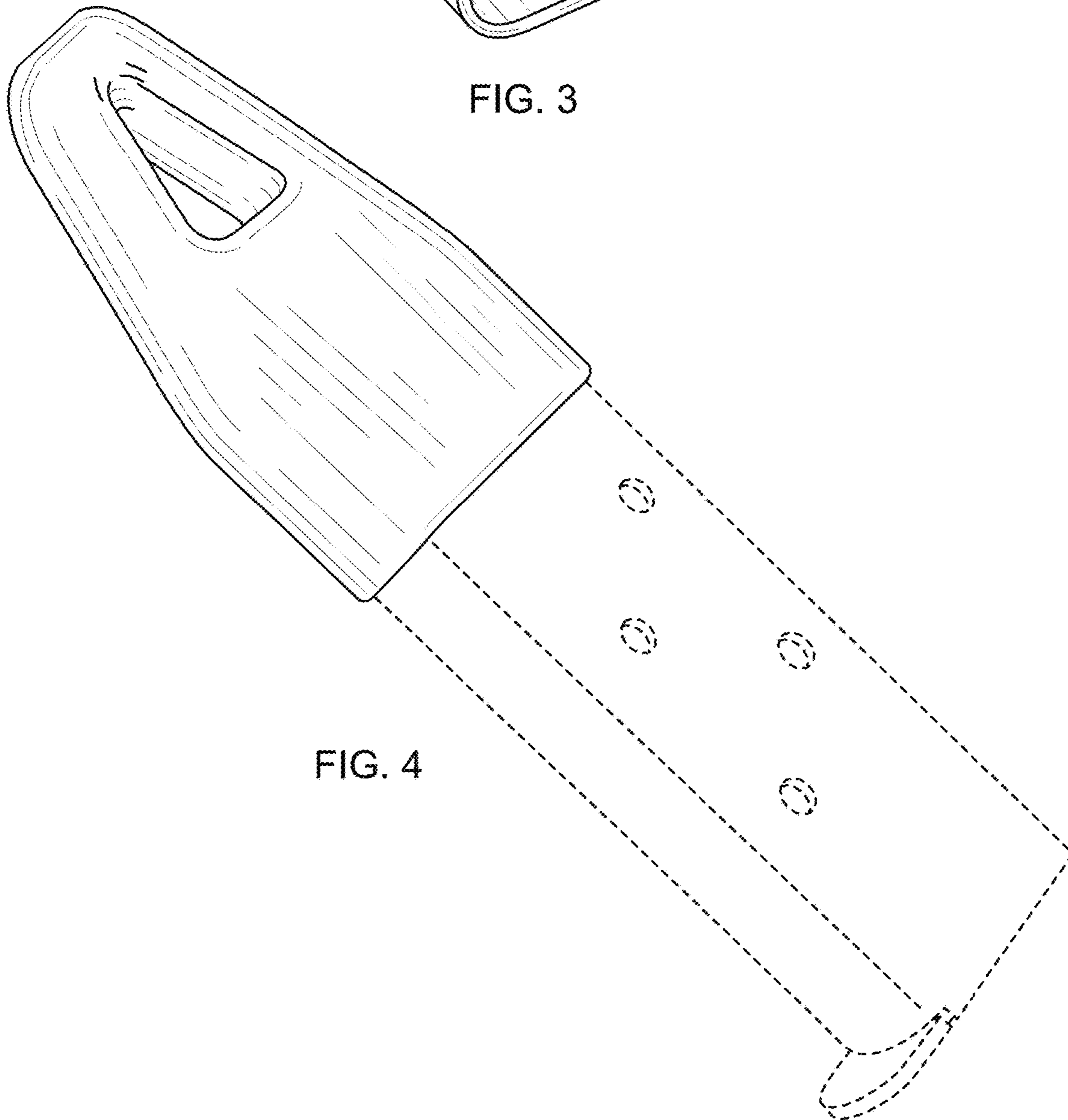

FIG. 4

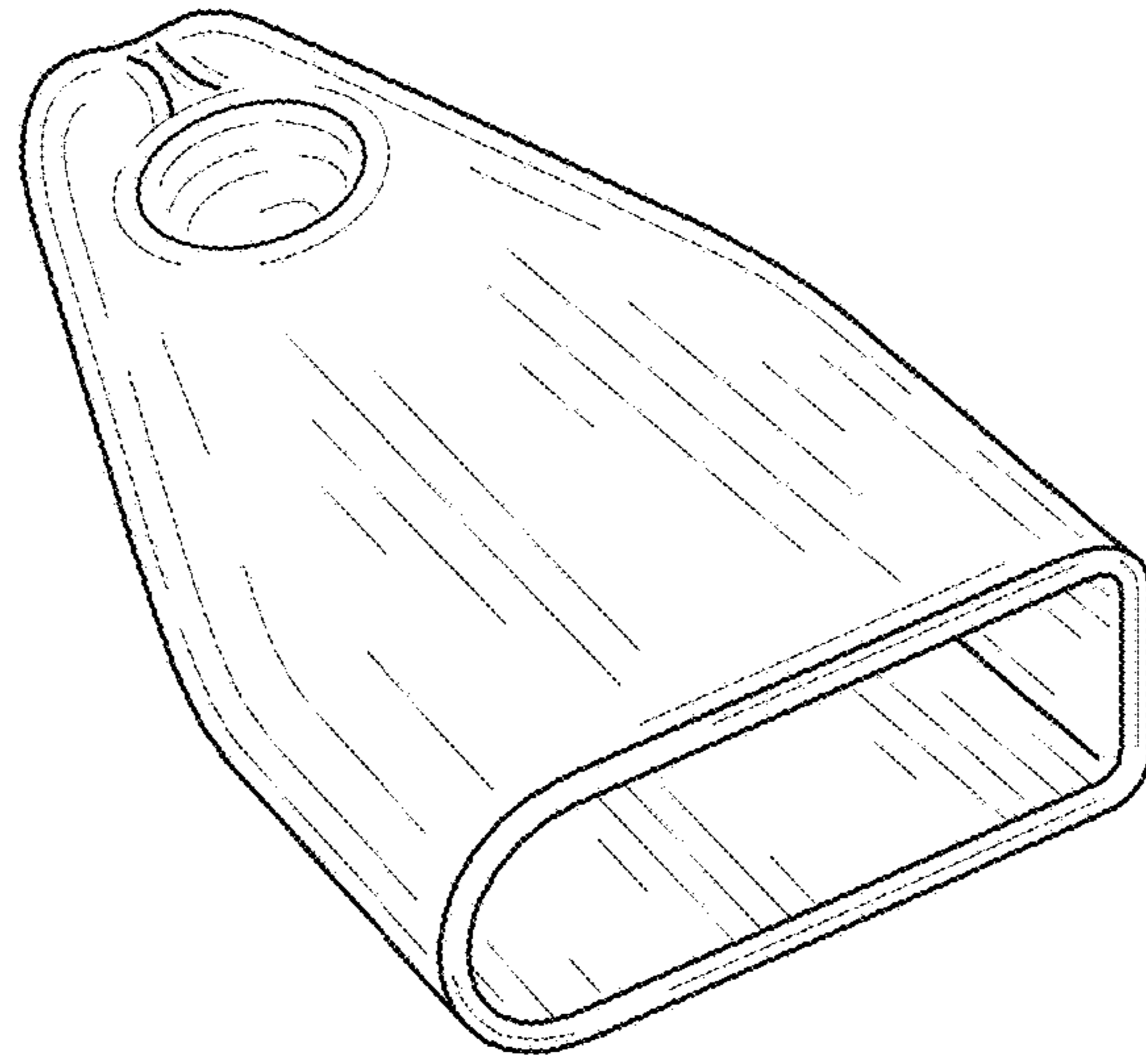

FIG. 5

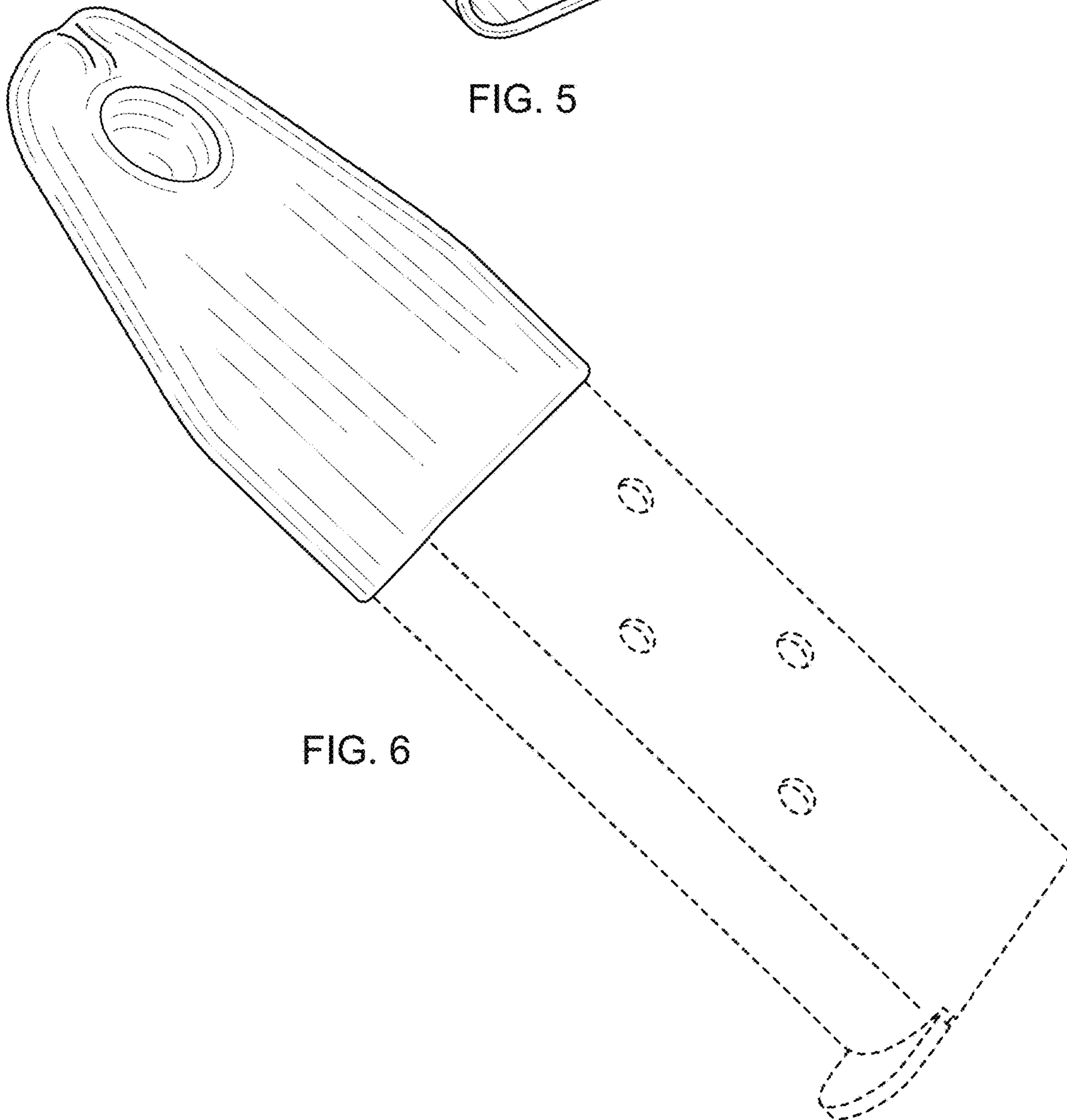

FIG. 6

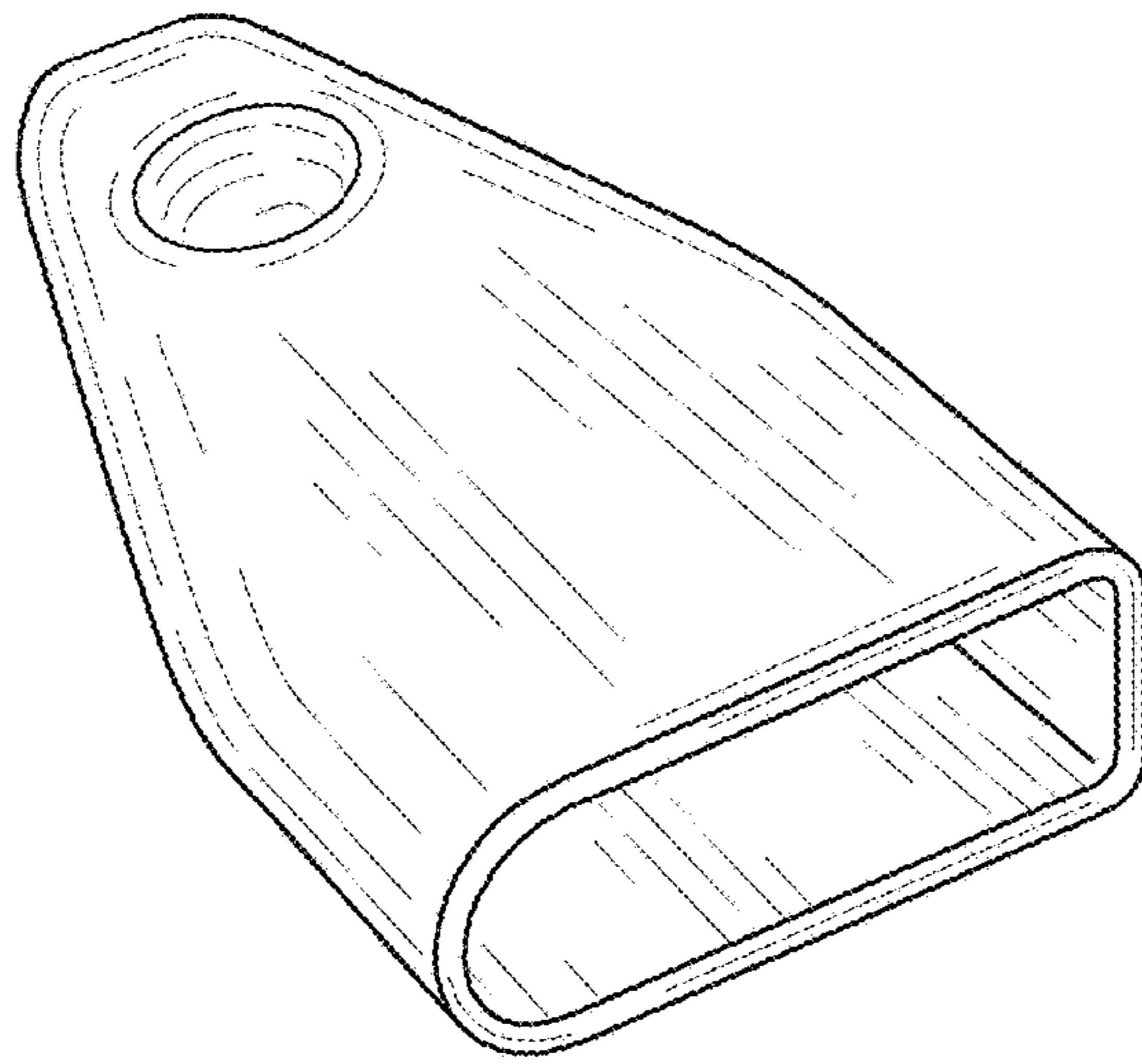

FIG. 7

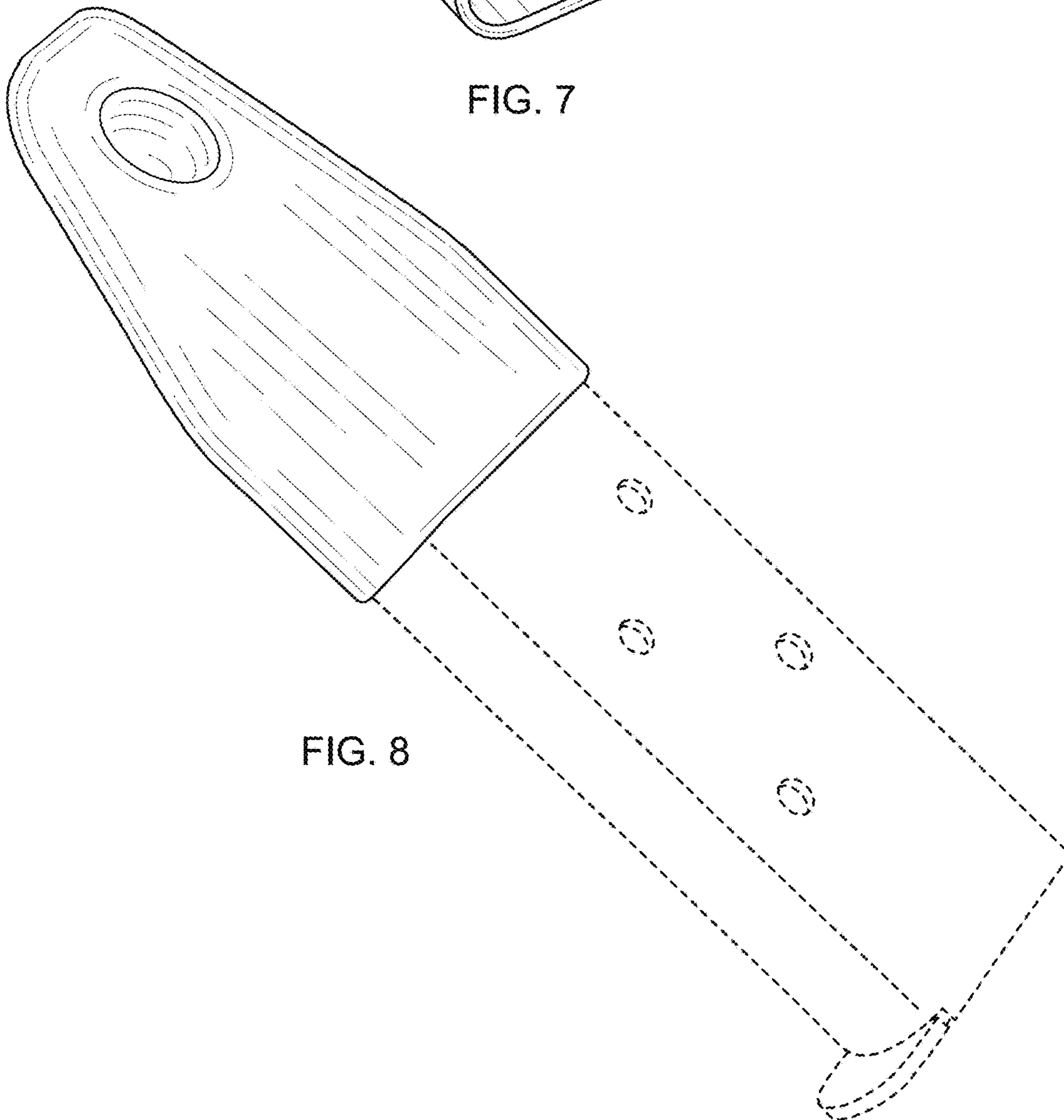

FIG. 8

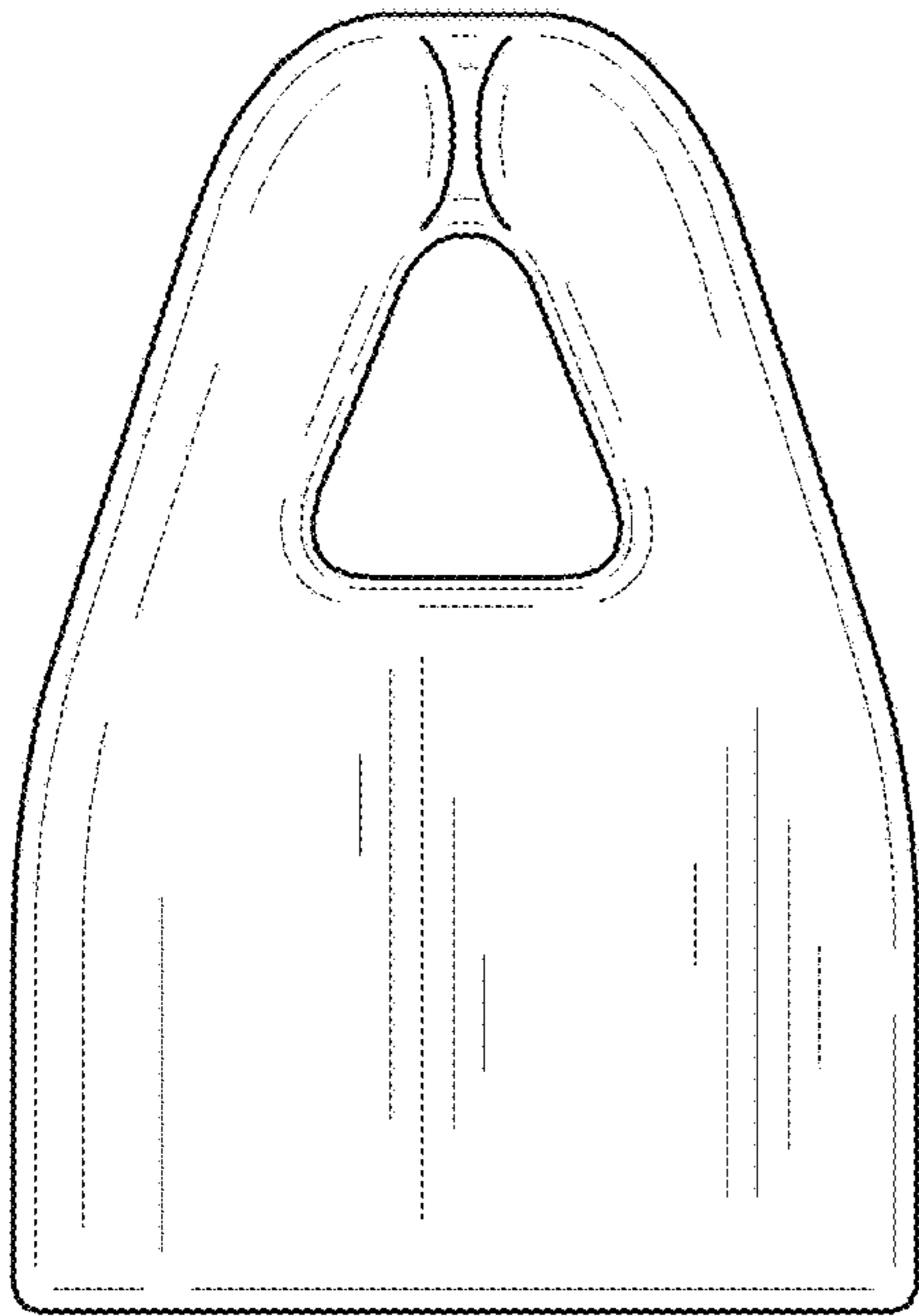

FIG. 9

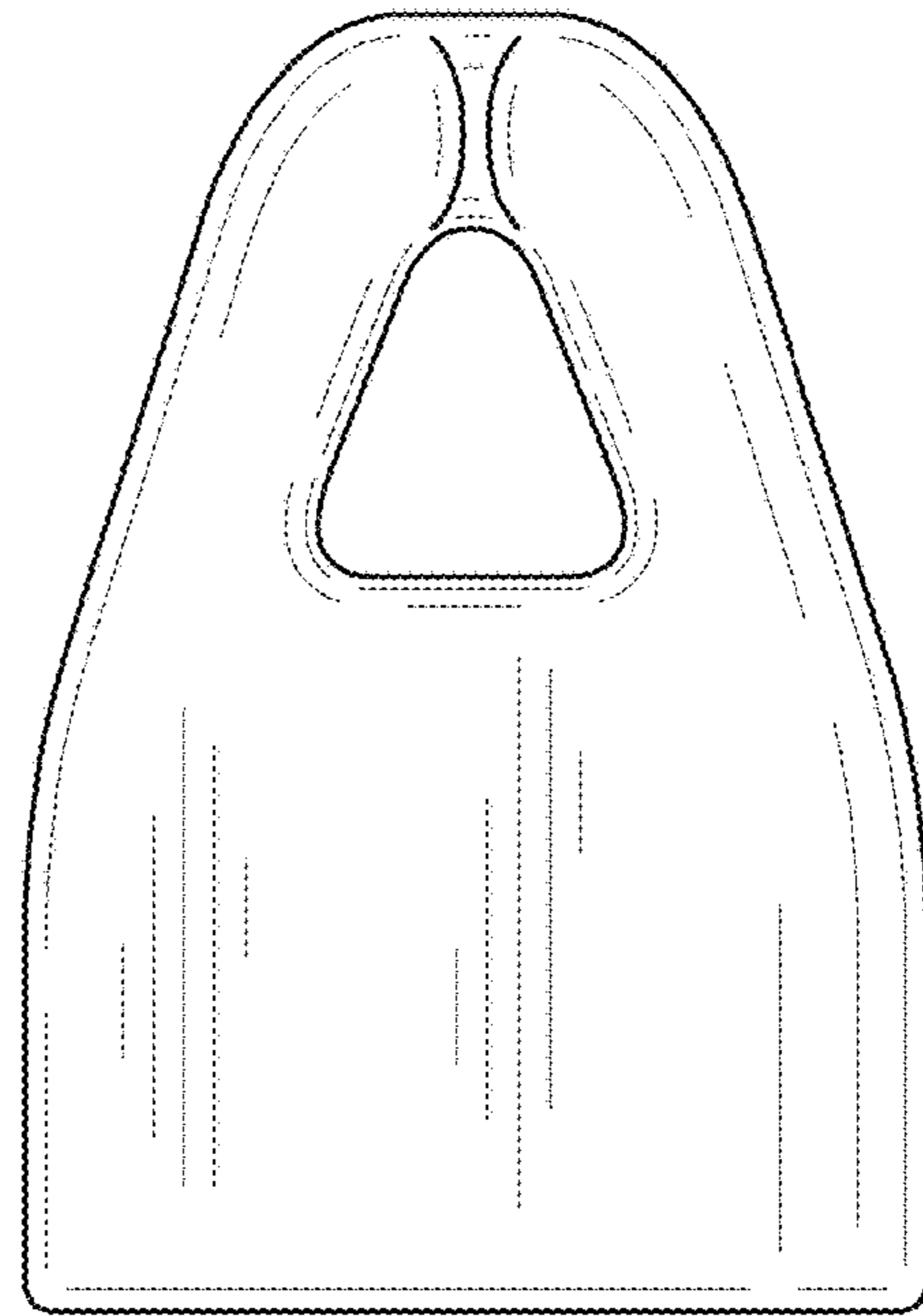

FIG. 10

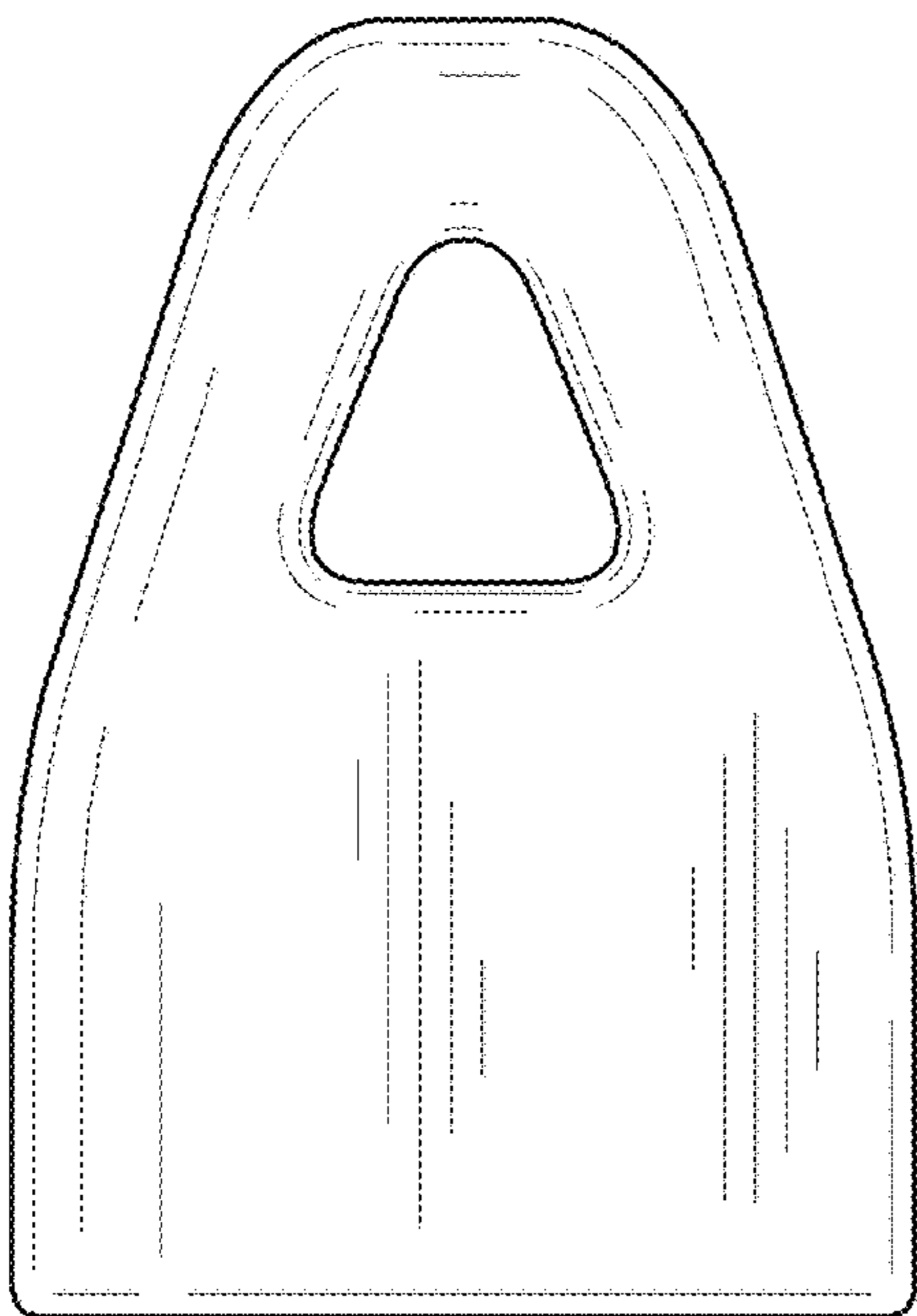

FIG. 11

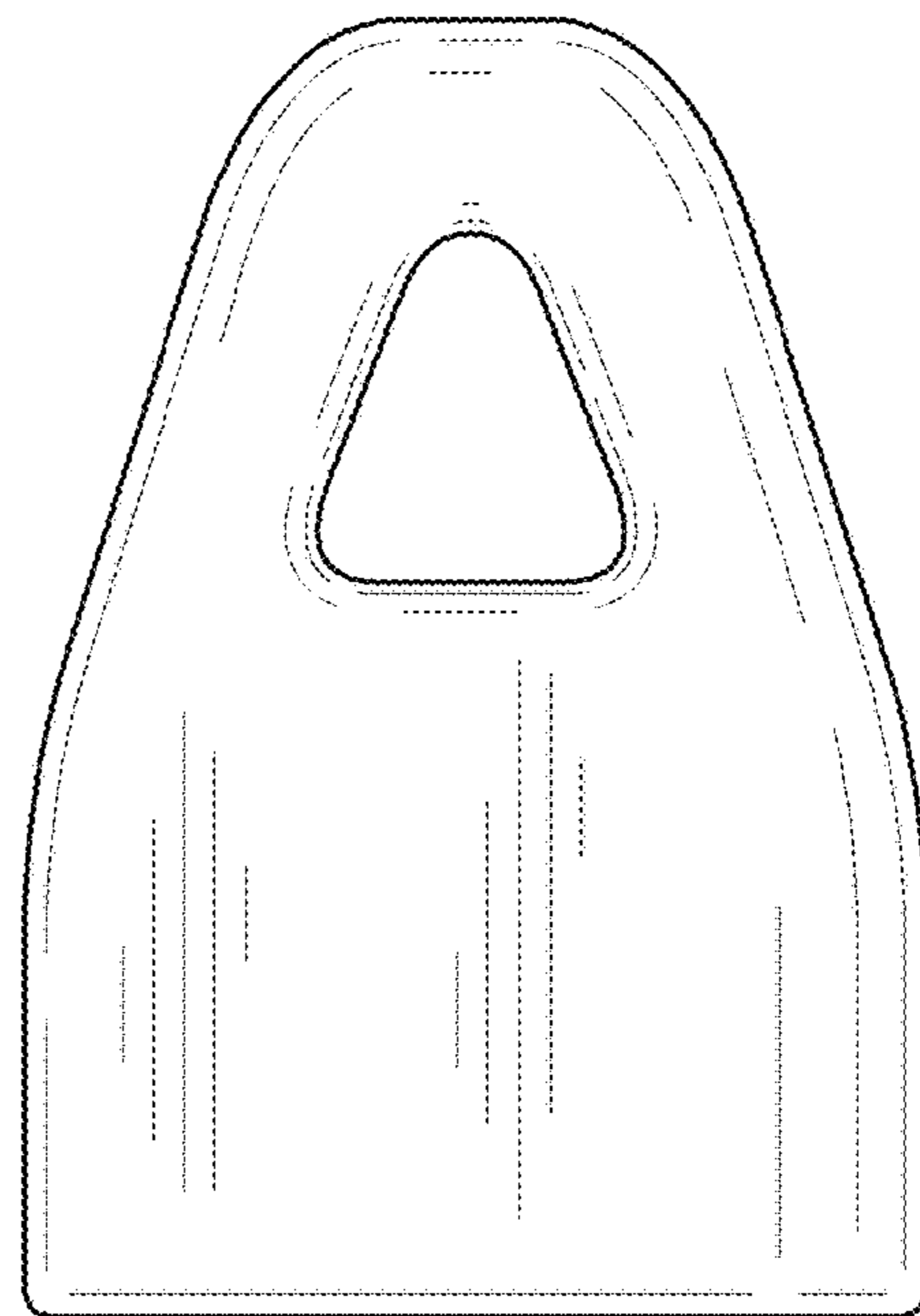

FIG. 12

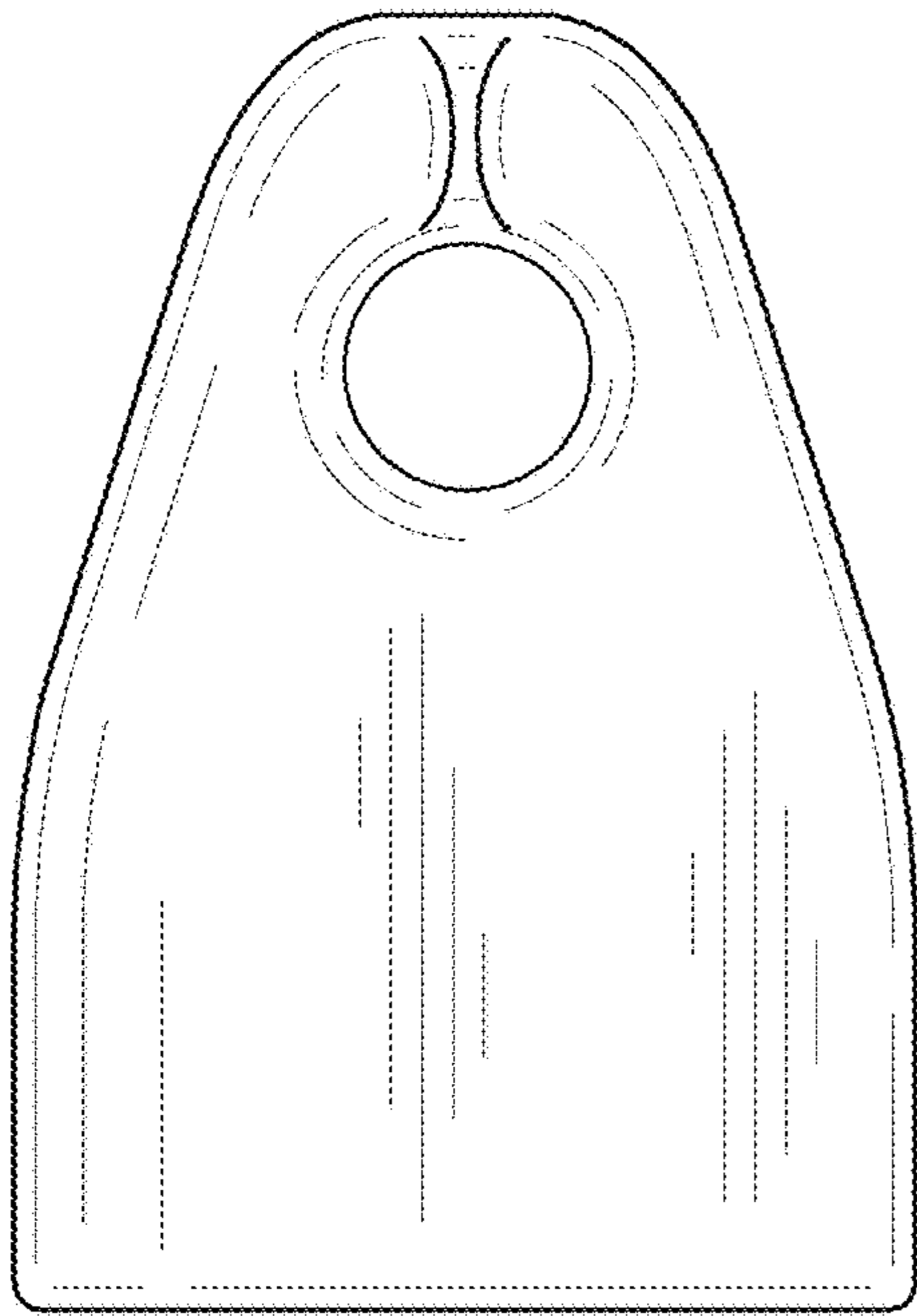

FIG. 13

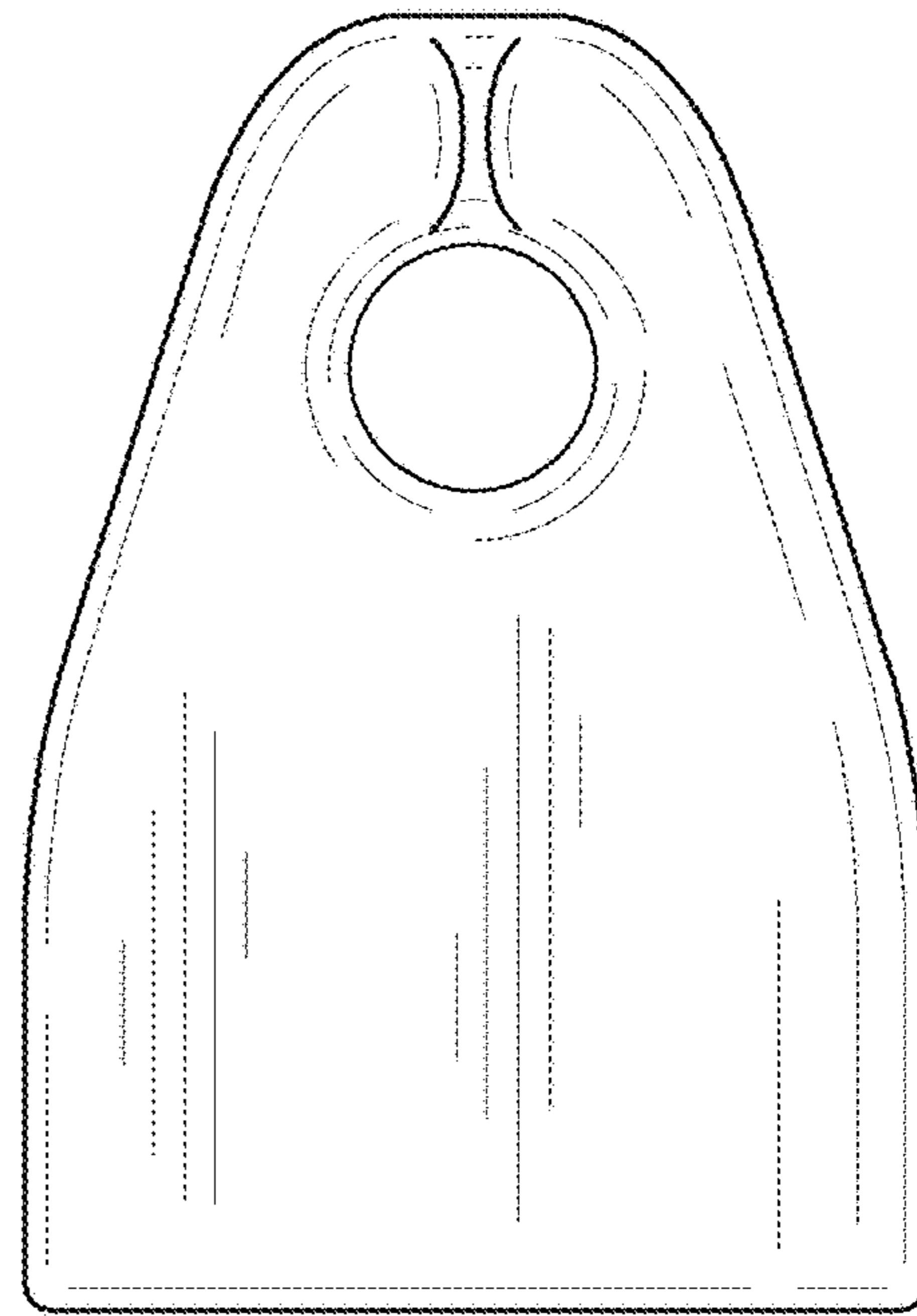

FIG. 14

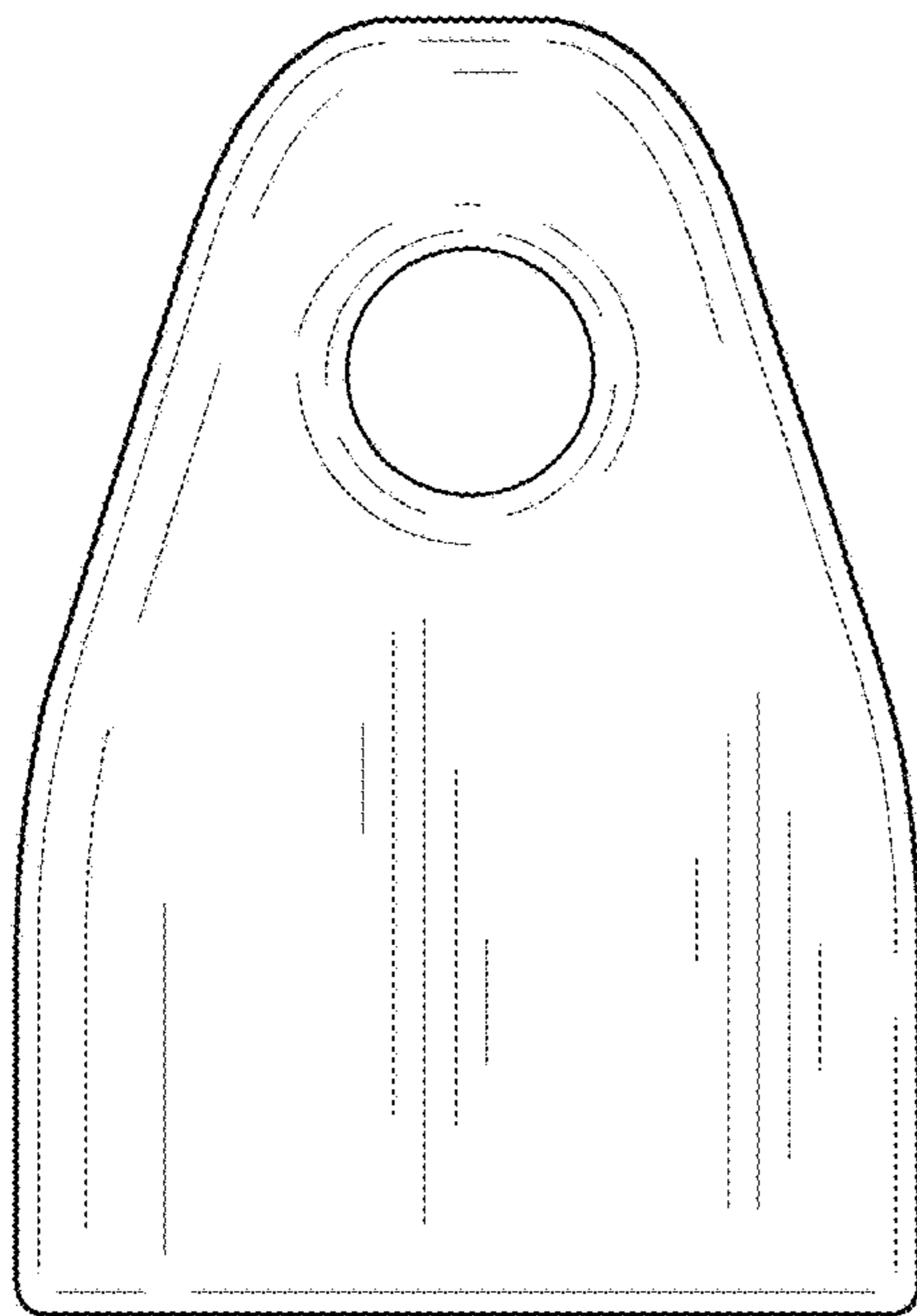

FIG. 15

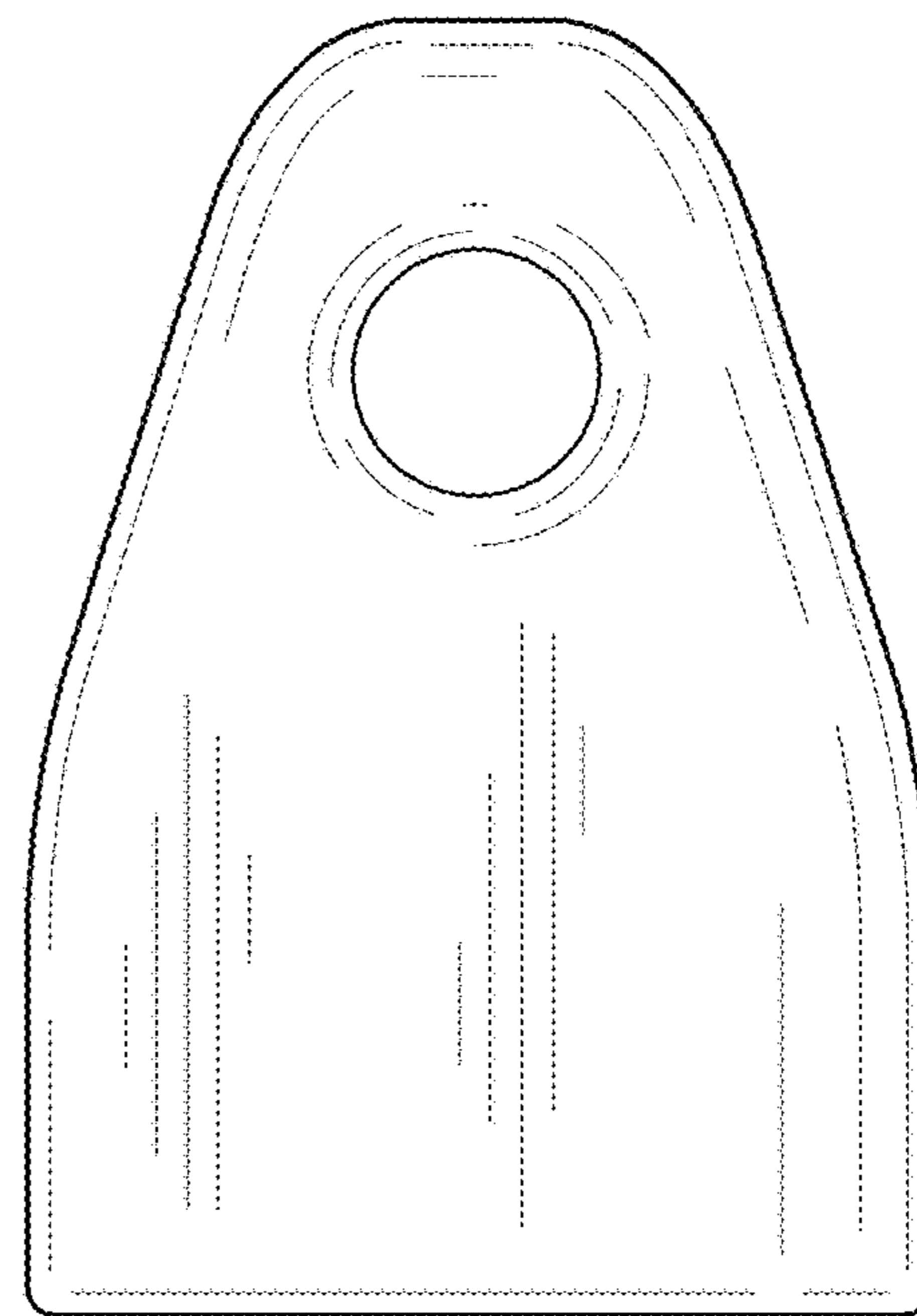

FIG. 16

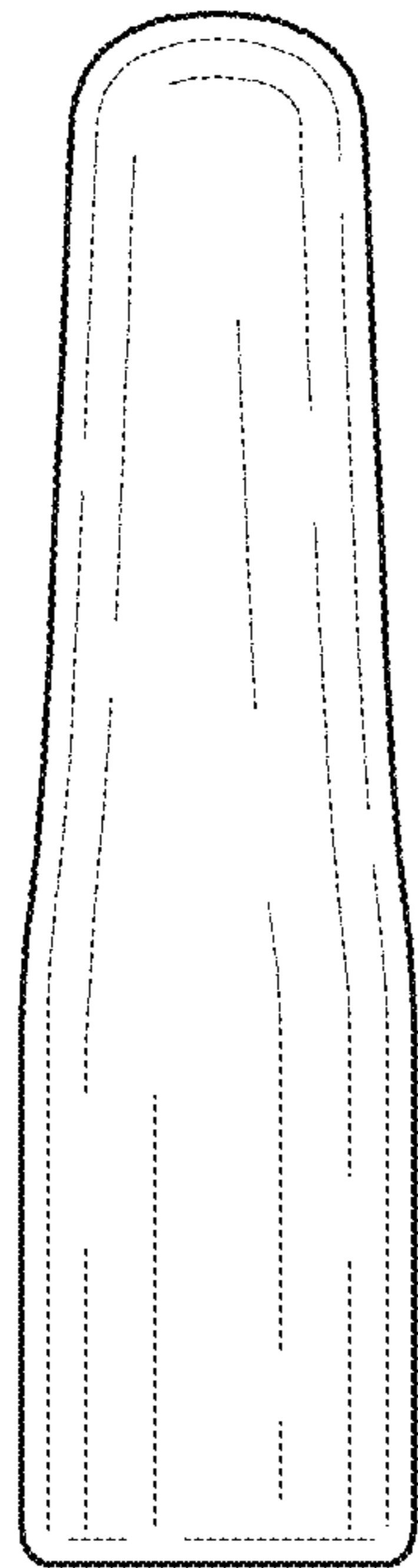

FIG. 17

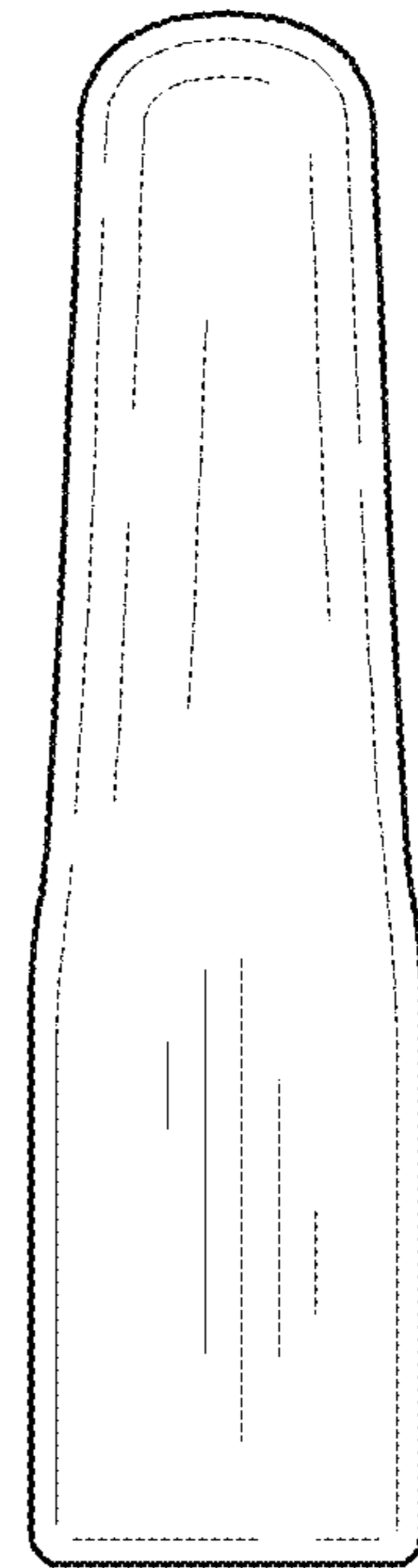

FIG. 18

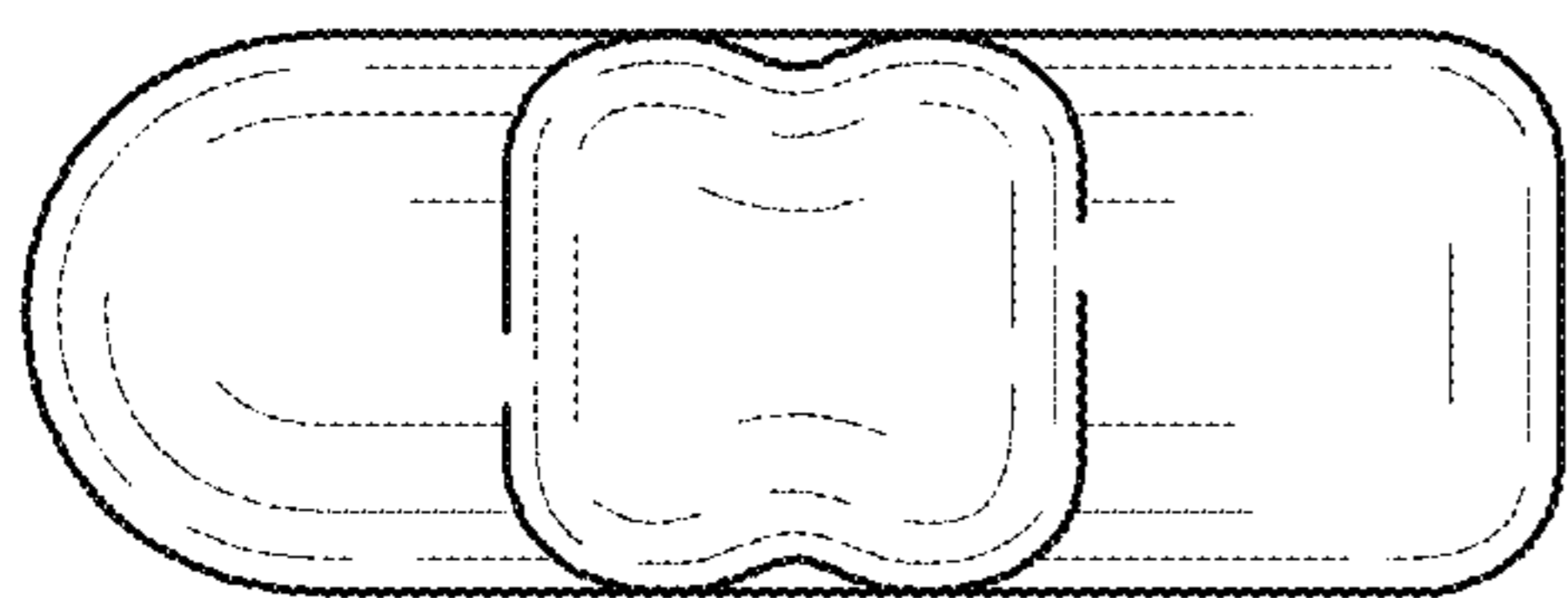

FIG. 19

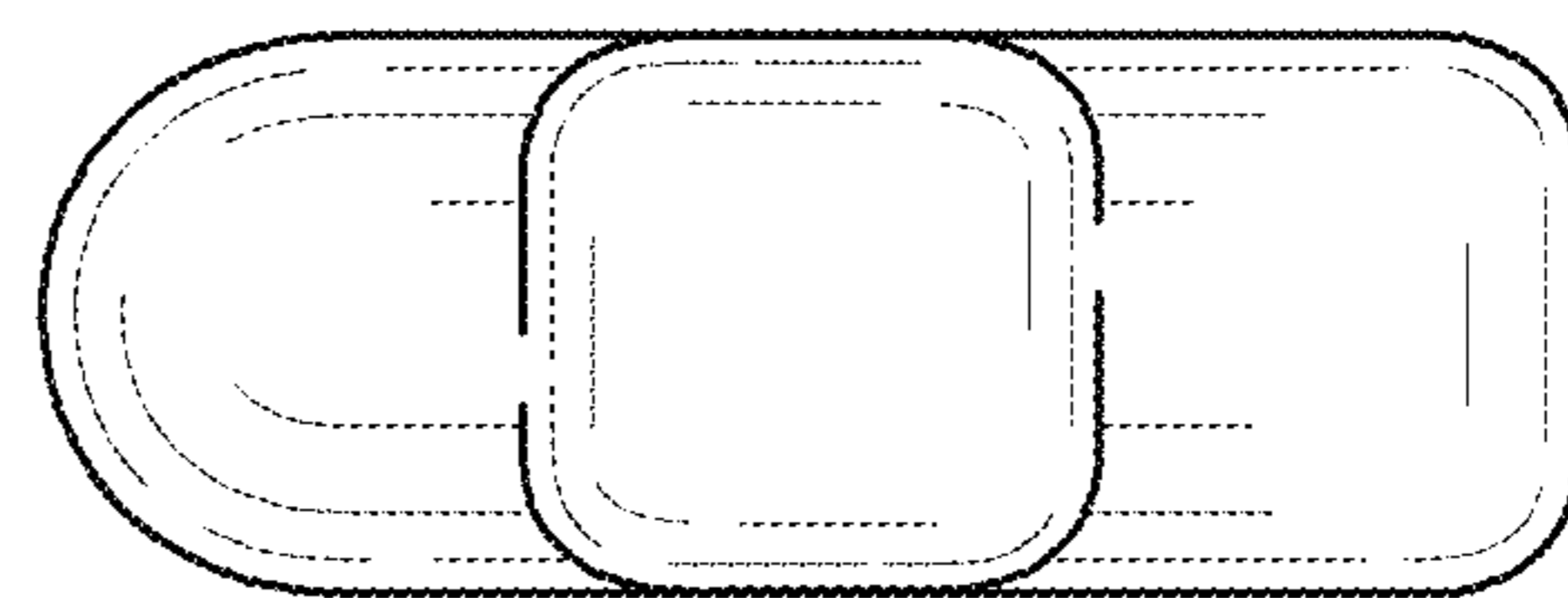

FIG. 20

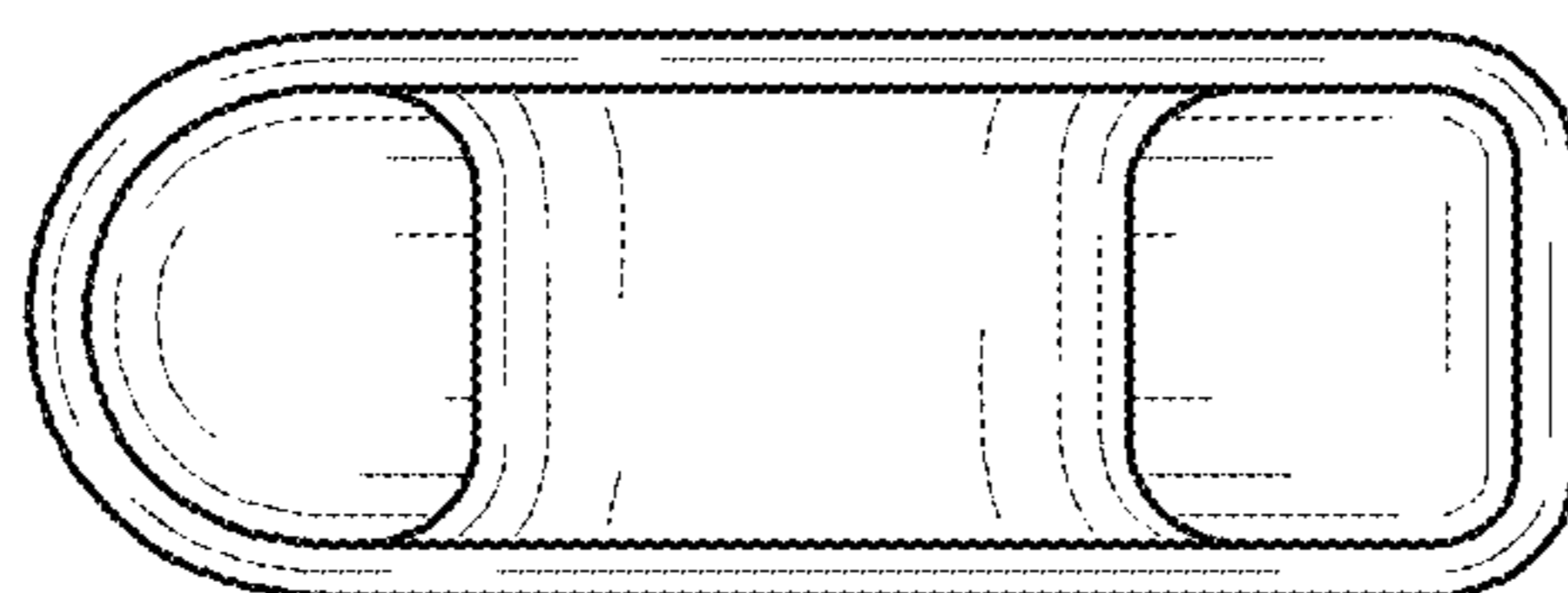

FIG. 21