



US00D821406S

(12) **United States Design Patent**  
**Turksu et al.**

(10) **Patent No.:** **US D821,406 S**  
(45) **Date of Patent:** **\*\* Jun. 26, 2018**

(54) **COMPUTER KEYPAD**  
(71) Applicant: **SARIANA, LLC**, San Diego, CA (US)  
(72) Inventors: **Alan Turksu**, San Diego, CA (US);  
**Mustafa Burak Guclu**, San Diego, CA (US)  
(73) Assignee: **SARIANA, LLC**, San Diego, CA (US)  
(\*\*) Term: **15 Years**

D554,648 S \* 11/2007 Massaro ..... D14/315  
D567,247 S \* 4/2008 Massaro ..... D14/455  
D570,855 S \* 6/2008 Massaro ..... D14/455  
D572,263 S \* 7/2008 Massaro ..... D14/455  
D604,736 S \* 11/2009 Andre ..... D14/392  
D621,402 S \* 8/2010 Andre ..... D14/392  
D635,610 S \* 4/2011 Tenbrink ..... D18/7  
D680,544 S \* 4/2013 Akana ..... D14/391  
D689,493 S \* 9/2013 Moore ..... D14/392

(Continued)

(21) Appl. No.: **29/558,588**  
(22) Filed: **Mar. 18, 2016**  
(51) **LOC (11) Cl.** ..... **14-02**  
(52) **U.S. Cl.**  
USPC ..... **D14/455**; D14/399  
(58) **Field of Classification Search**  
USPC ..... D14/388, 389, 390, 391, 392, 396, 397,  
D14/398, 399, 400, 401, 320, 331, 333,  
D14/334, 338, 339, 341, 346, 356, 347,  
D14/379, 380, 384, 218, 455; D18/6, 7,  
D18/8, 12, 12.1, 12.2, 24, 29, 57; D19/6,  
D19/9, 10; D20/11; D21/324-333, 517,  
D21/512; D99/43, 99; D13/162, 162.1,  
D13/164, 168, 184, 123  
CPC .... G06F 15/02; G06F 15/0216; G06F 15/025;  
G06F 15/0225; G06F 15/0258; G06F  
1/1671; G06F 1/02; G06F 7/544; G06F  
7/60; G06F 3/04883; G06F 3/04812;  
G06F 3/021; G09B 19/025; H01H 13/83  
See application file for complete search history.

**OTHER PUBLICATIONS**

Want to know a Chromebook Secret—Keyboard Shortcut Overlay\_ITC Chronicles.By:TechTalk4Teachers. eiuitc.blogspot.com [online] p. 4/6. Posted Feb. 11, 2014 [retrieved on Jul. 5, 2017] <http://eiuitc.blogspot.com/2014/02/want-to-know-chromebook-secret-keyboard.html>.\*

(Continued)

*Primary Examiner* — Susan Bennett Hattan  
*Assistant Examiner* — Marie D. Fast Horse  
(74) *Attorney, Agent, or Firm* — Wagenknecht IP Law Group PC

(57) **CLAIM**

What is claimed is an ornamental design for a computer keypad, as shown and described.

**DESCRIPTION**

FIG. 1 is a top, back, left isometric view of a computer keypad showing our new design;  
FIG. 2 is a top plan view thereof;  
FIG. 3 is a bottom plan view thereof;  
FIG. 4 is back elevational view thereof;  
FIG. 5 is a front elevational view thereof;  
FIG. 6 is right side elevational view thereof; and,  
FIG. 7 is a left side elevational view thereof.  
wherein the broken lines in the drawing depict portions of the computer keypad that form no part of the claimed design.

**1 Claim, 4 Drawing Sheets**

(56) **References Cited**  
U.S. PATENT DOCUMENTS

D279,190 S \* 6/1985 Tsumura ..... D14/398  
D286,047 S \* 10/1986 Roots ..... D14/399  
D327,881 S \* 7/1992 McFarlane ..... D14/399  
D329,848 S \* 9/1992 Mizusugi ..... D14/399  
D370,899 S \* 6/1996 Yu ..... D14/456  
D546,333 S \* 7/2007 Emmerich ..... D14/455

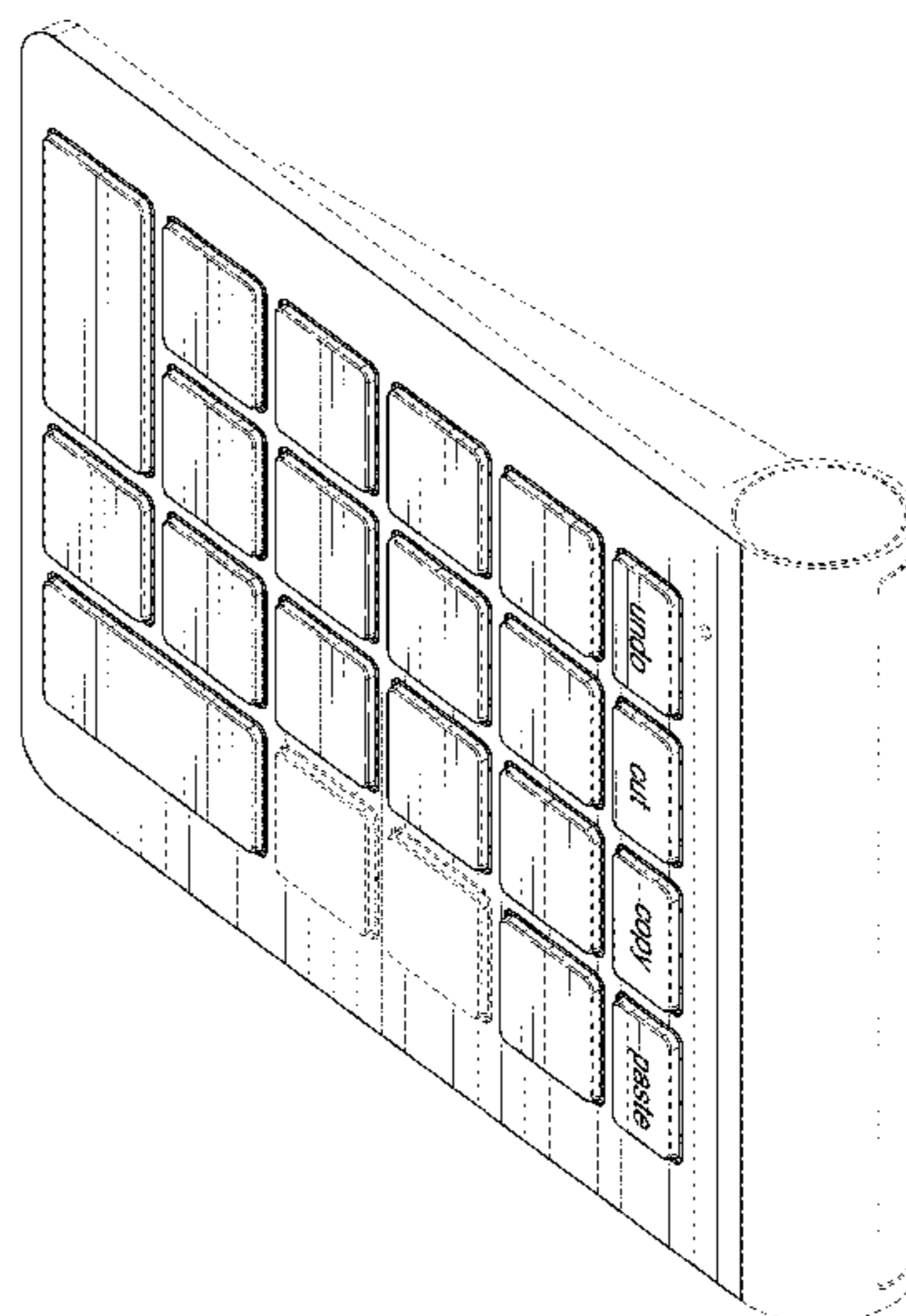

(56)

**References Cited**

U.S. PATENT DOCUMENTS

D691,607	S	*	10/2013	Kim	.....	D14/399
D700,570	S	*	3/2014	Raeber	.....	D13/102
D724,589	S	*	3/2015	Ozolins	.....	D14/392
D735,719	S	*	8/2015	Ozolins	.....	D14/392
D735,720	S	*	8/2015	Ozolins	.....	D14/392
D757,023	S	*	5/2016	Bowers	.....	D14/455
D769,964	S	*	10/2016	Lu	.....	D14/399
D774,511	S	*	12/2016	Moon	.....	D14/392
2004/0246150	A1	*	12/2004	Sheehan	.....	G06F 3/021 341/22
2007/0045392	A1	*	3/2007	Youens	.....	G06F 1/1632 235/145 R
2007/0222757	A1	*	9/2007	Tsai	.....	G06F 1/3203 345/168
2009/0173610	A1	*	7/2009	Bronstein	.....	H01H 13/83 200/314

OTHER PUBLICATIONS

fs2-pc-keypad. kinesis-ergo.com. (online image) 1 pg. uploaded Aug. 2013. [retrieved on Jul. 5, 2017] <https://www.kinesis-ergo.com/wp-content/uploads/2013/08/fs2-pc-keypad.jpg>.\*

office-keyboard-shortcuts-994x400. makeuseof.com (online image) 1 pg. uploaded Nov. 2015. [retrieved on Jul. 5, 2017] <http://cdn.makeuseof.com/wp-content/uploads/2015/11/office-keyboard-shortcuts-994x400.jpg?x92042>.\*

\* cited by examiner

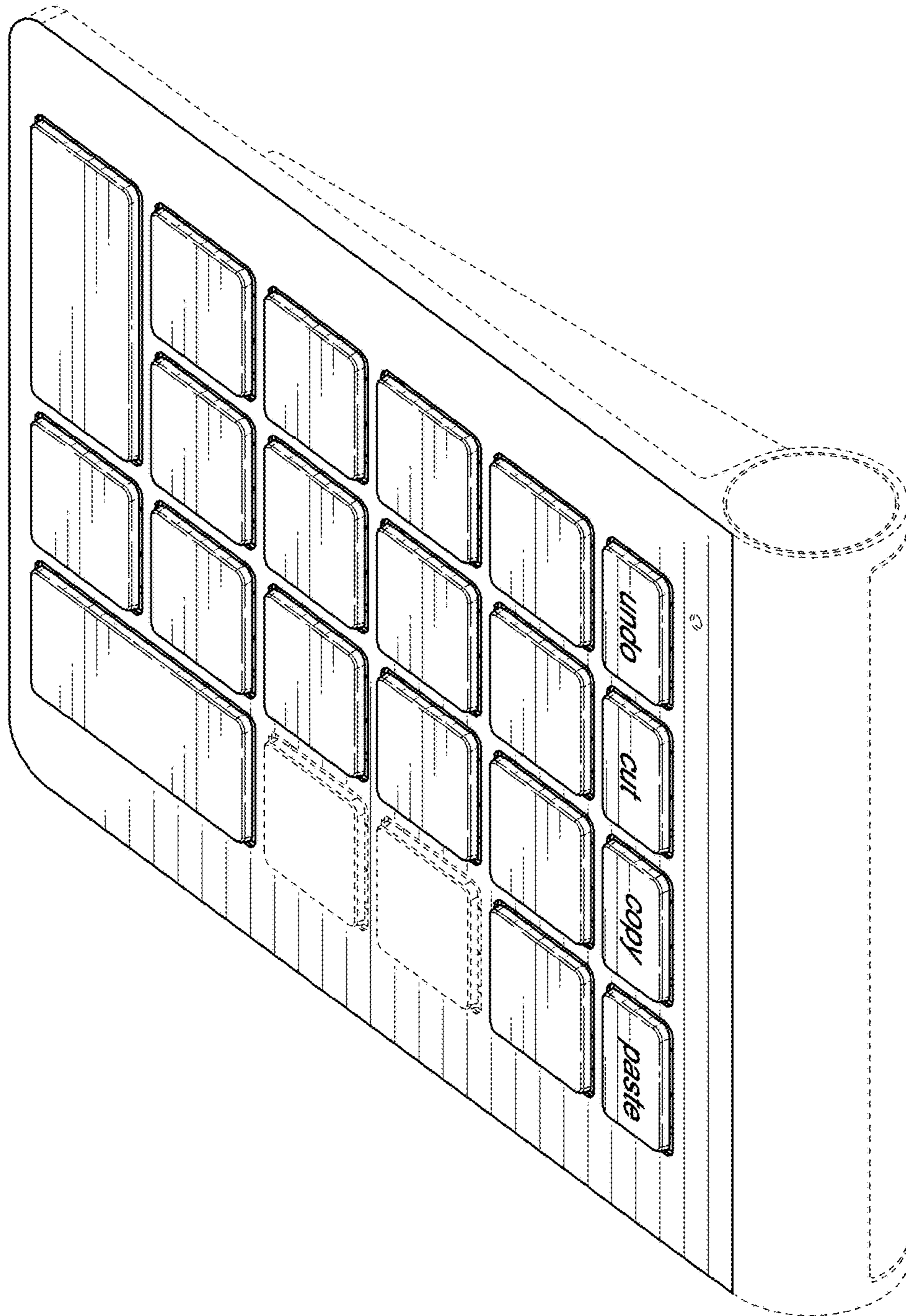

FIG. 1

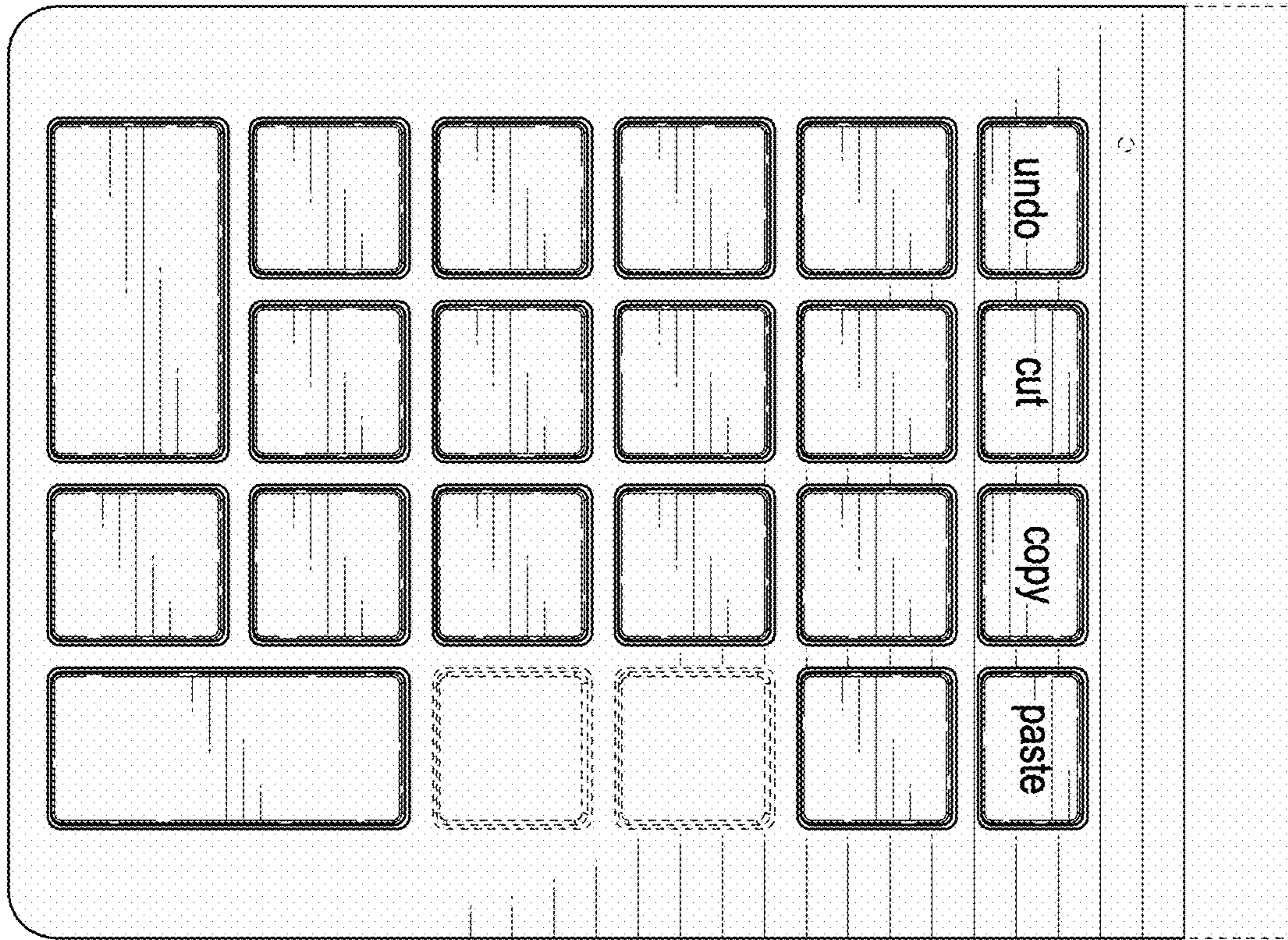

FIG. 2

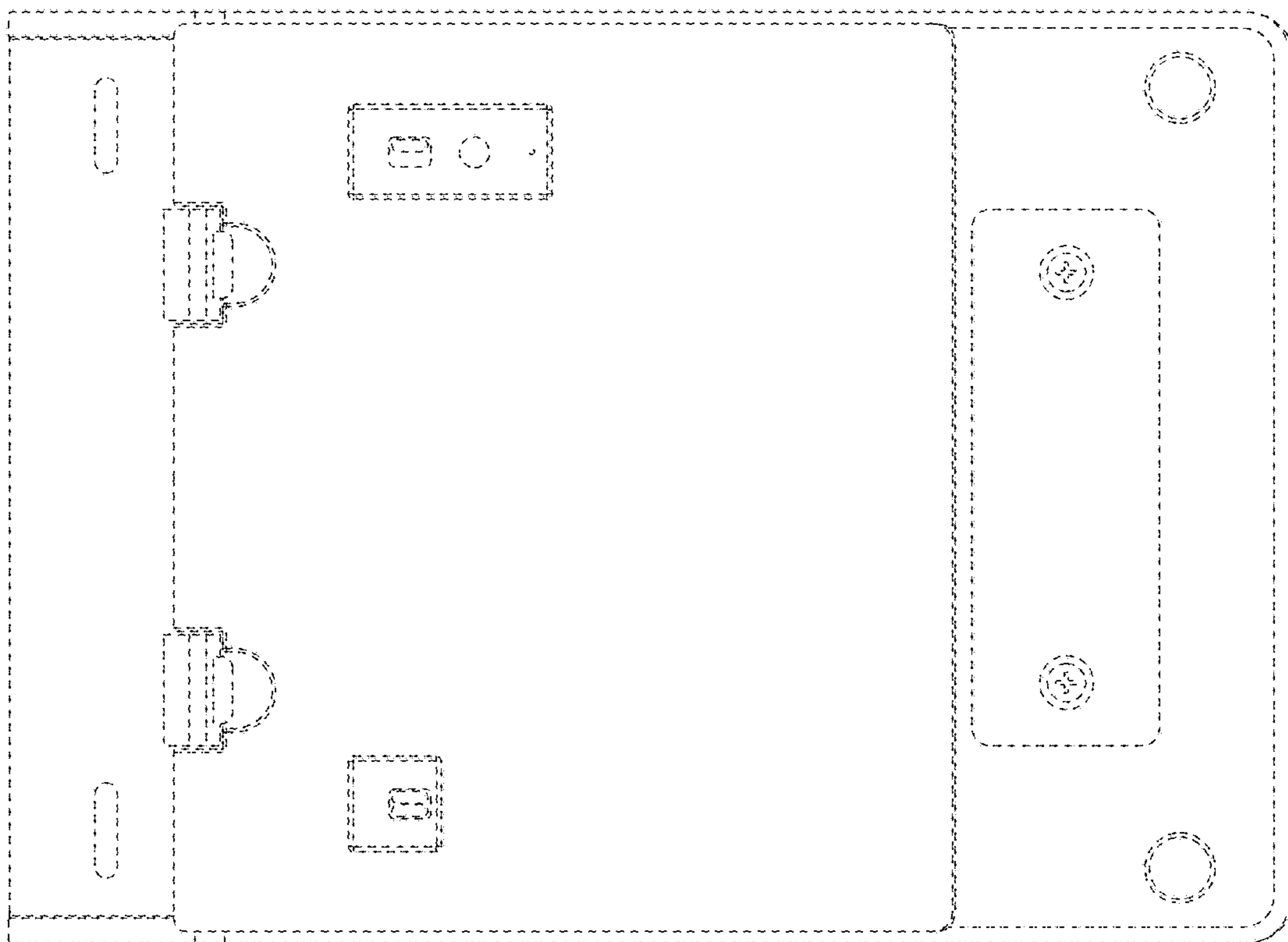

FIG. 3

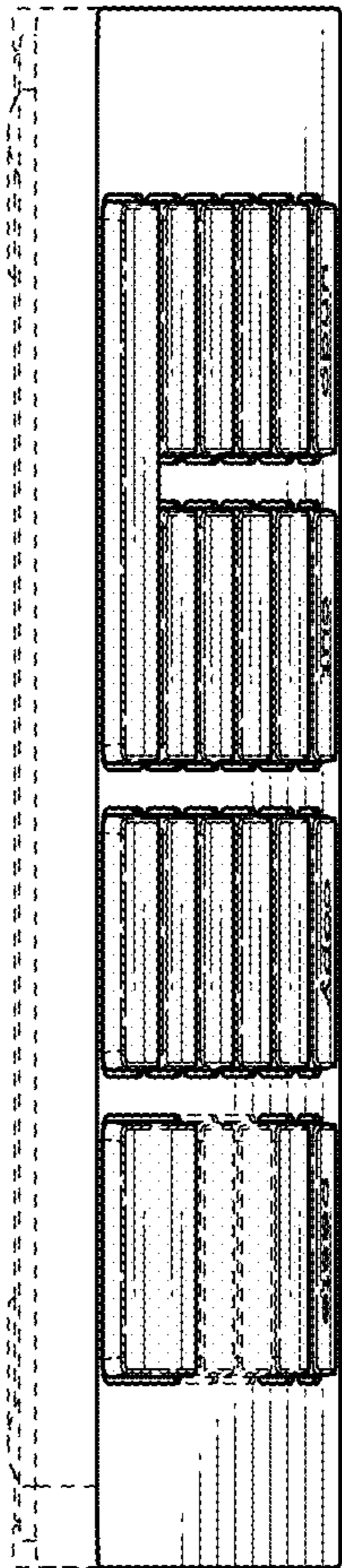

FIG. 4

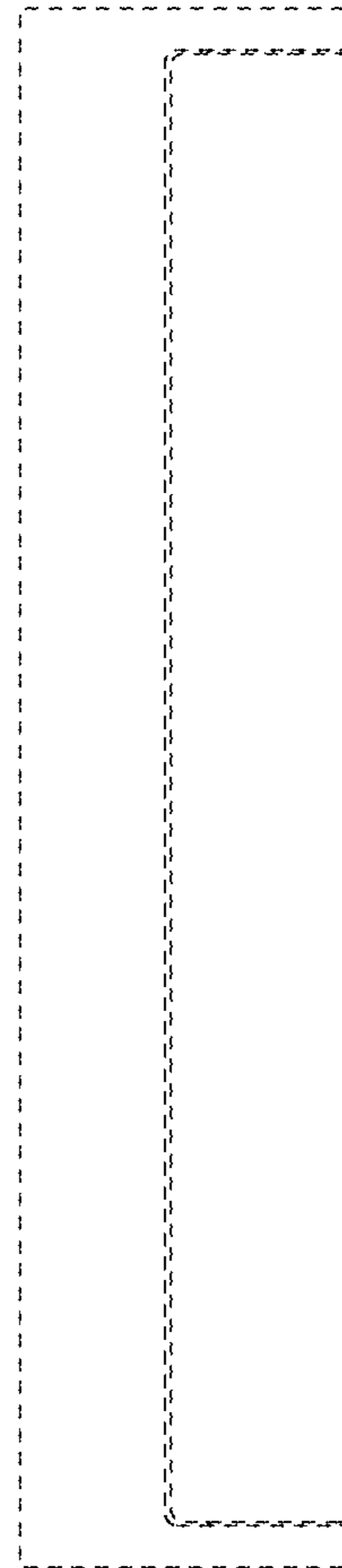

FIG. 5

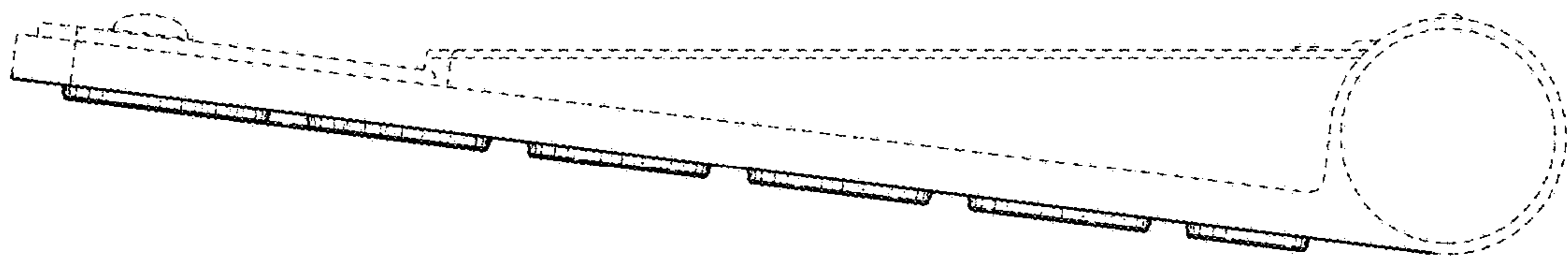

FIG. 6

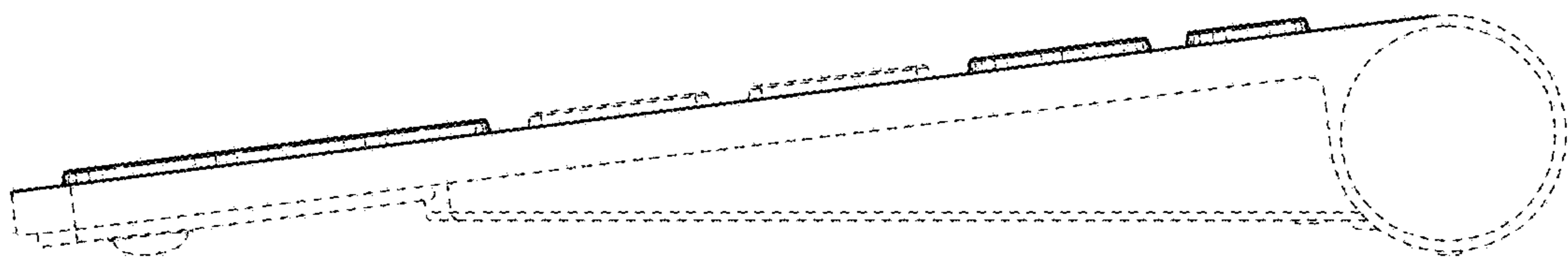

FIG. 7