



US00D821400S

(12) **United States Design Patent**
Pang et al.

(10) **Patent No.:** **US D821,400 S**
(45) **Date of Patent:** **** Jun. 26, 2018**

- (54) **MOUSE**
- (71) Applicant: **Shenzhen Riitek Technology Co., Ltd.**,
Shenzhen, Guangdong (CN)
- (72) Inventors: **Xianyong Pang**, Shenzhen (CN);
Junkui Chen, Shenzhen (CN)
- (73) Assignee: **Shenzhen Riitek Technology Co., Ltd.**,
Shenzhen, Guangdong (CN)

(**) Term: **15 Years**

(21) Appl. No.: **29/600,960**

(22) Filed: **Apr. 17, 2017**

(51) **LOC (11) Cl.** **14-02**

(52) **U.S. Cl.**
USPC **D14/409**

(58) **Field of Classification Search**
USPC D14/402–411, 356, 388, 389, 383–385,
D14/417, 426; 345/156–167; 463/36–38;
358/471, 473; 273/148 B
CPC G06F 3/03543; G06F 2203/0333; G06F
3/039; G06F 3/038; G06F 2203/0384
See application file for complete search history.

(56) **References Cited**

U.S. PATENT DOCUMENTS

- D591,294 S * 4/2009 Manalo D14/402
- D618,685 S * 6/2010 Haase D14/409
- D640,257 S * 6/2011 Lee D14/410

- D688,245 S * 8/2013 Guerra D14/409
- D688,664 S * 8/2013 Guerra D14/409
- D711,380 S * 8/2014 Urban D14/410
- D712,903 S * 9/2014 Lai D14/409
- D718,310 S * 11/2014 Moon D14/409
- D729,804 S * 5/2015 Jost D14/410
- D744,485 S * 12/2015 Young D14/409
- D749,076 S * 2/2016 Helwig D14/409
- D771,046 S * 11/2016 Jost D14/410
- D794,638 S * 8/2017 Zheng D14/409
- 2009/0046064 A1 * 2/2009 Manalo G06F 3/03543
345/164

* cited by examiner

Primary Examiner — Austin Murphy

(74) *Attorney, Agent, or Firm* — Raymond Y. Chan;
David and Raymond Patent Firm

(57) **CLAIM**

The ornamental design for a mouse, as shown and described.

DESCRIPTION

FIG. 1 is a perspective view of the mouse showing my new design;
FIG. 2 is a rear view of the mouse;
FIG. 3 is a front view of the mouse;
FIG. 4 is a left view of the mouse;
FIG. 5 is a right view of the mouse;
FIG. 6 is a top view of the mouse; and,
FIG. 7 is a bottom view of the mouse.
The surface(s) or poration(s) of the article shown in broken lines in the drawings being for illustrative purpose only and forming no part of the claimed design.

1 Claim, 7 Drawing Sheets

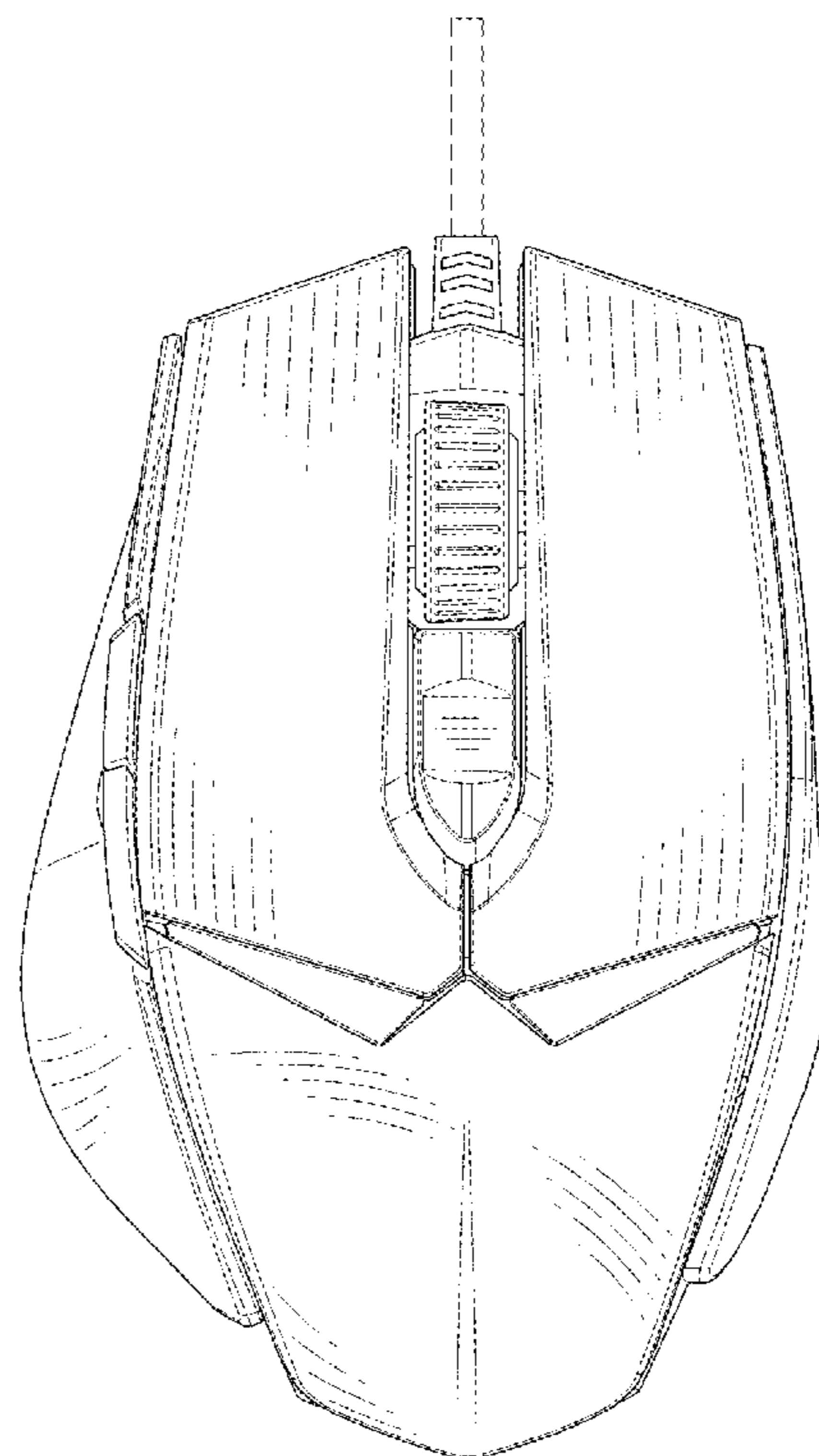
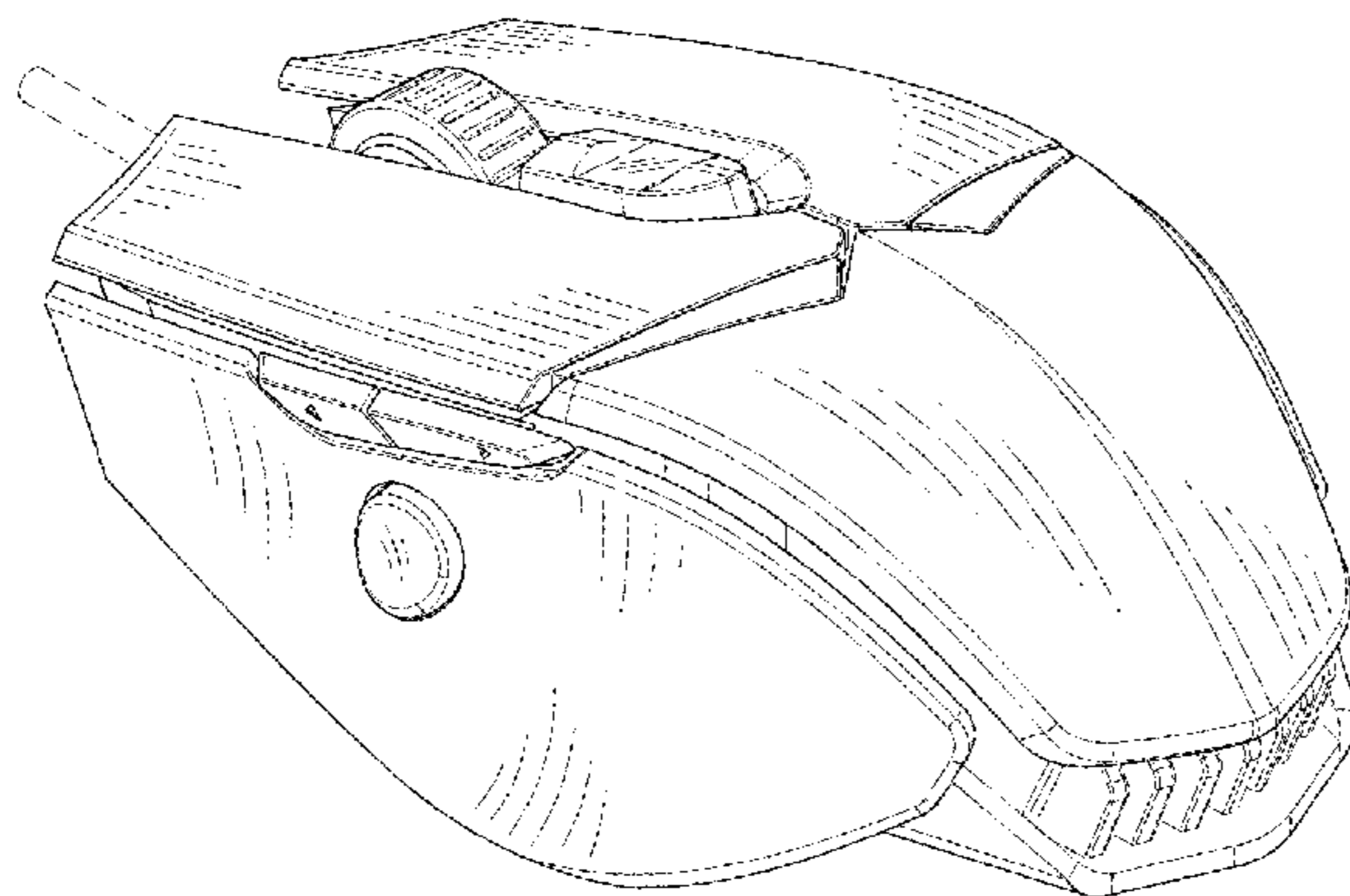

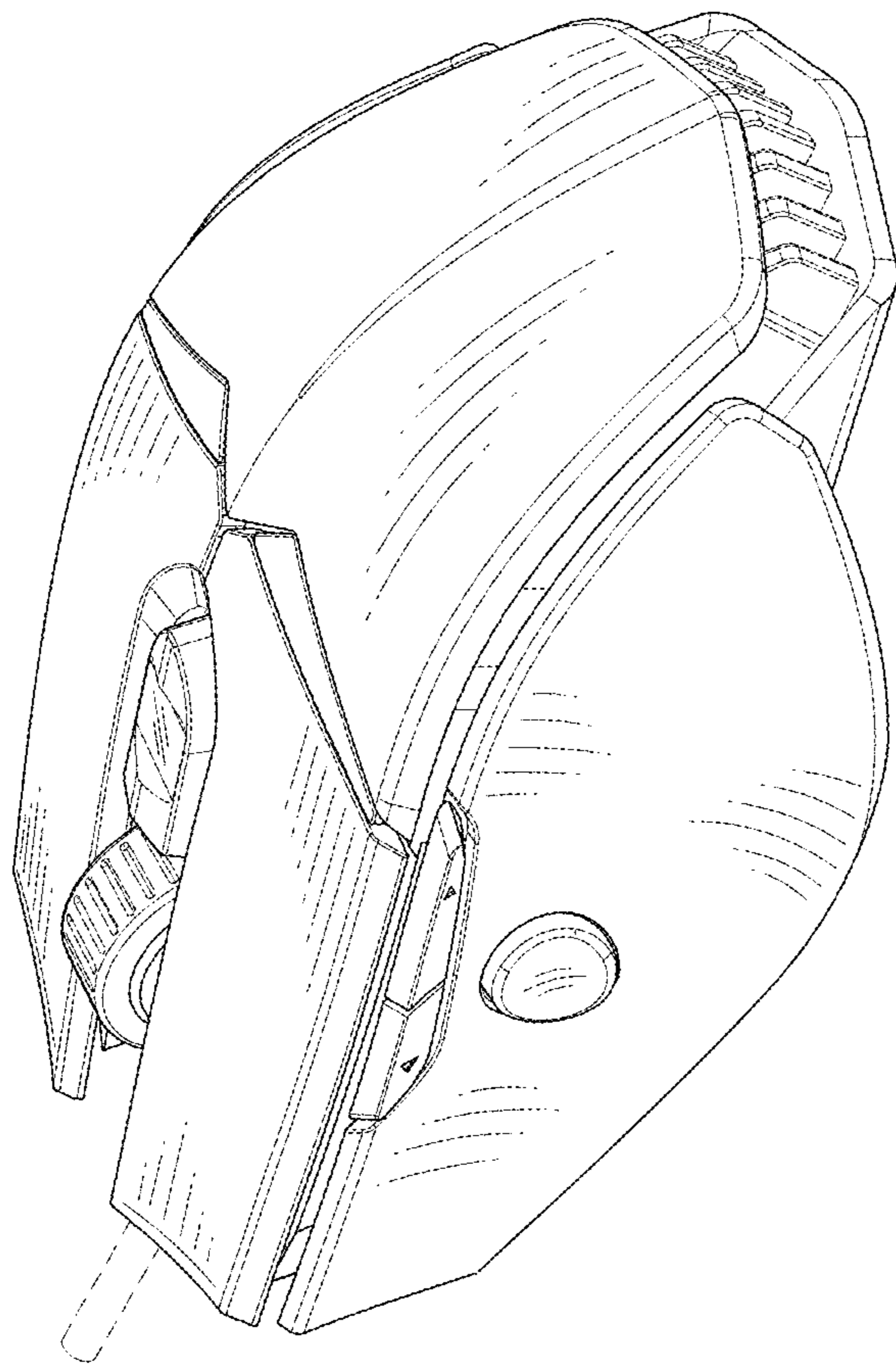

FIG.1

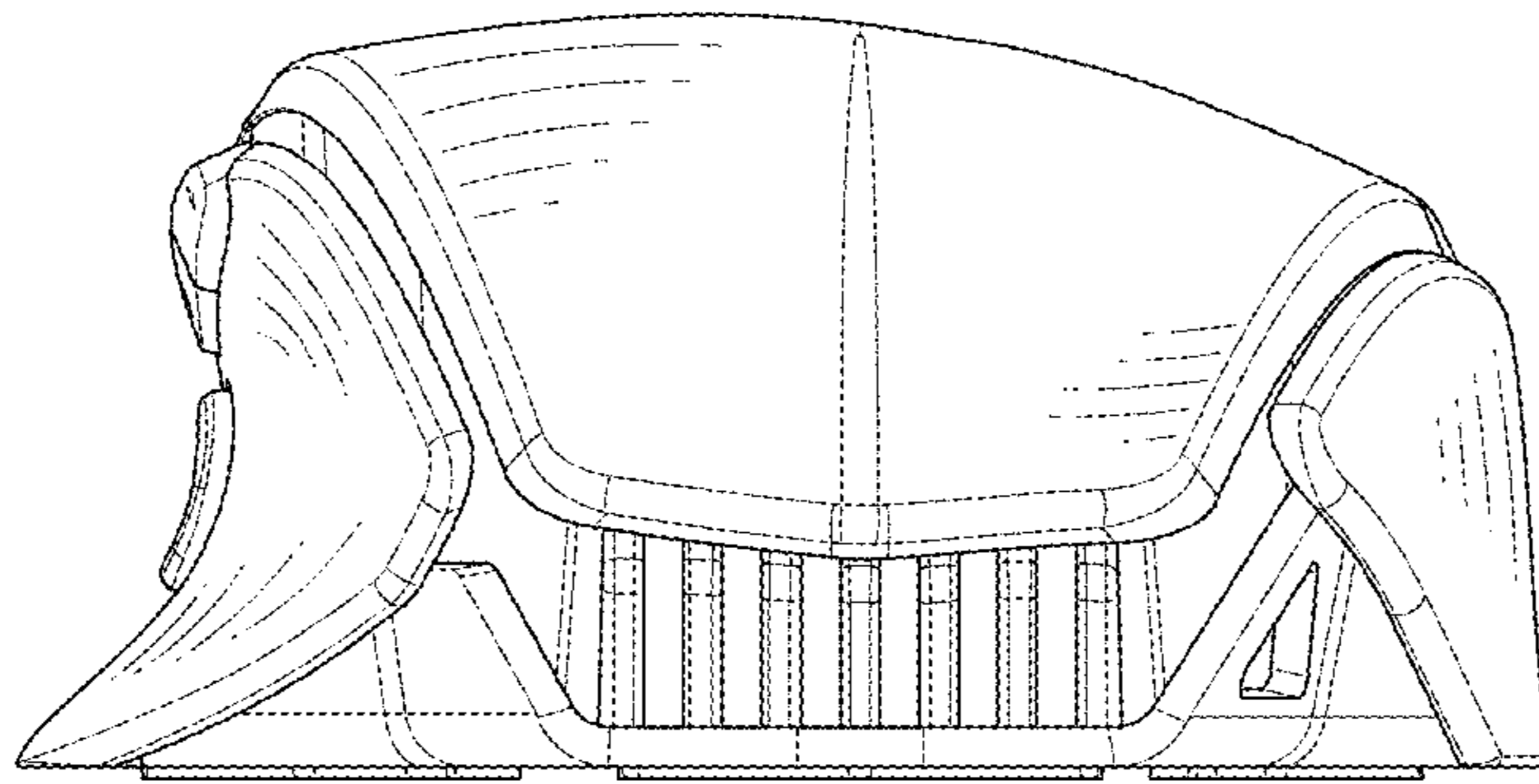

FIG.2

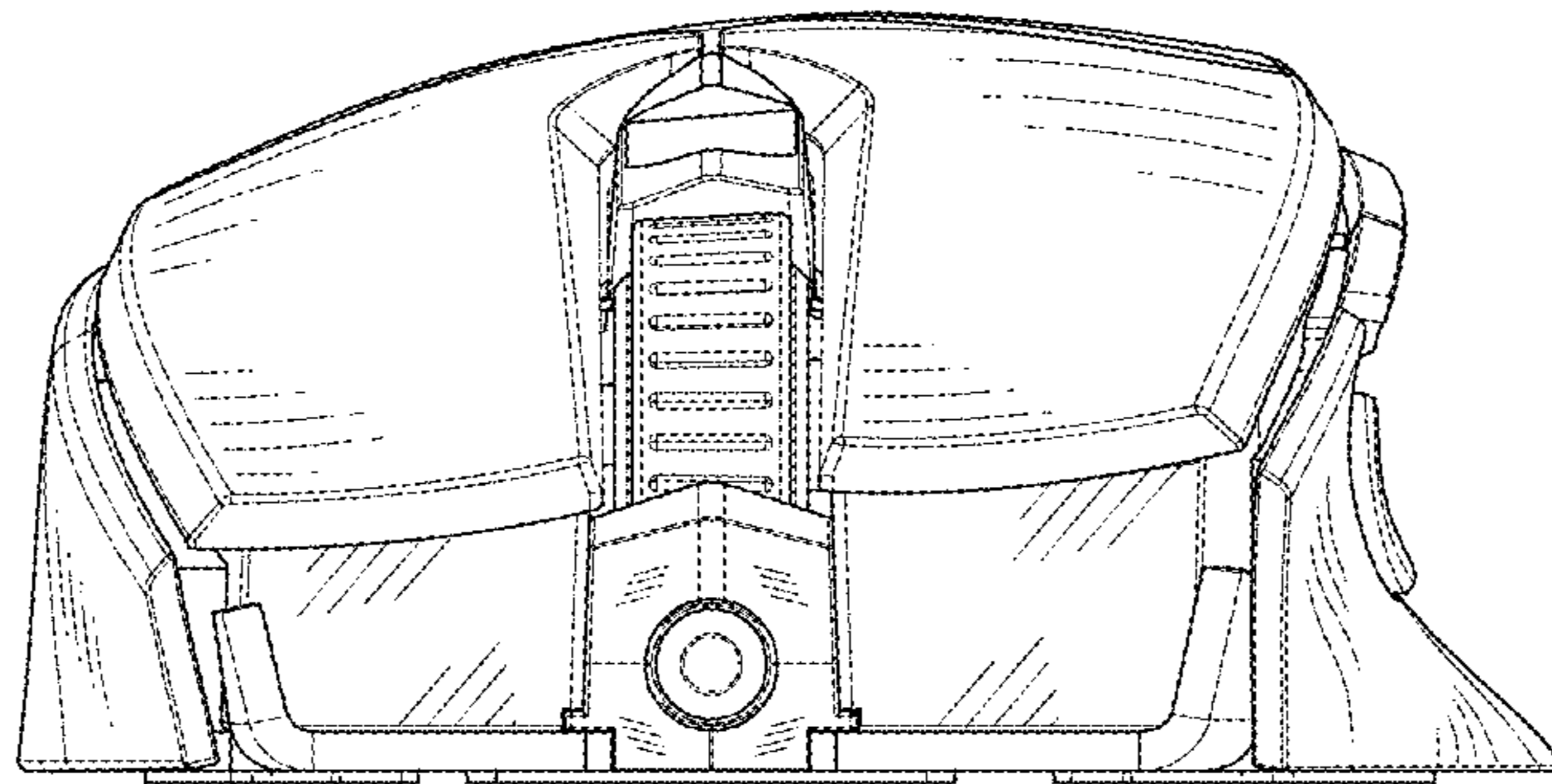

FIG.3

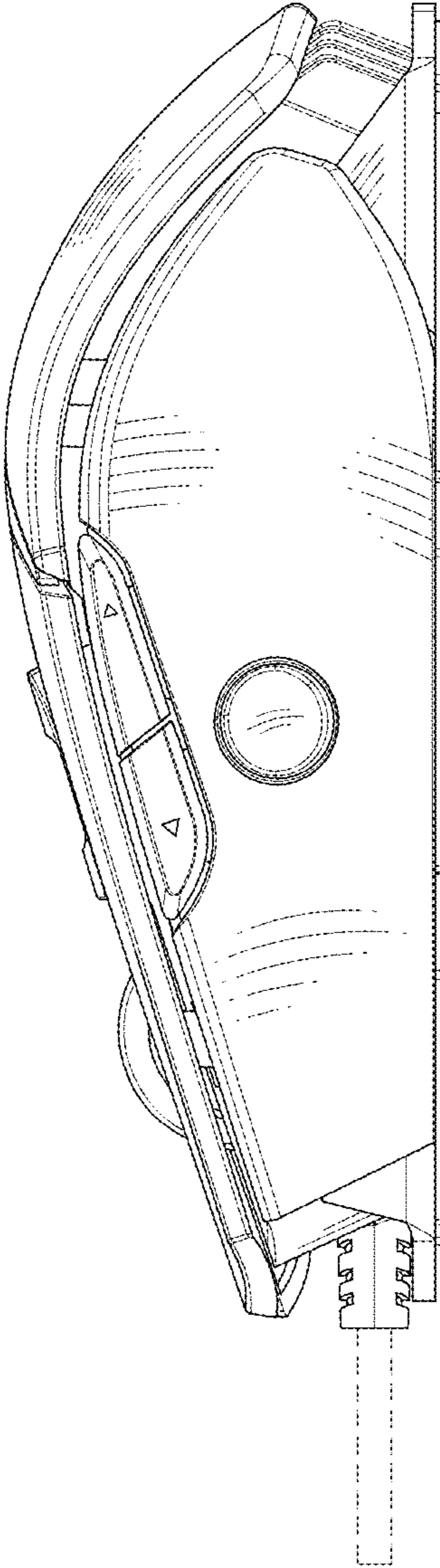

FIG.4

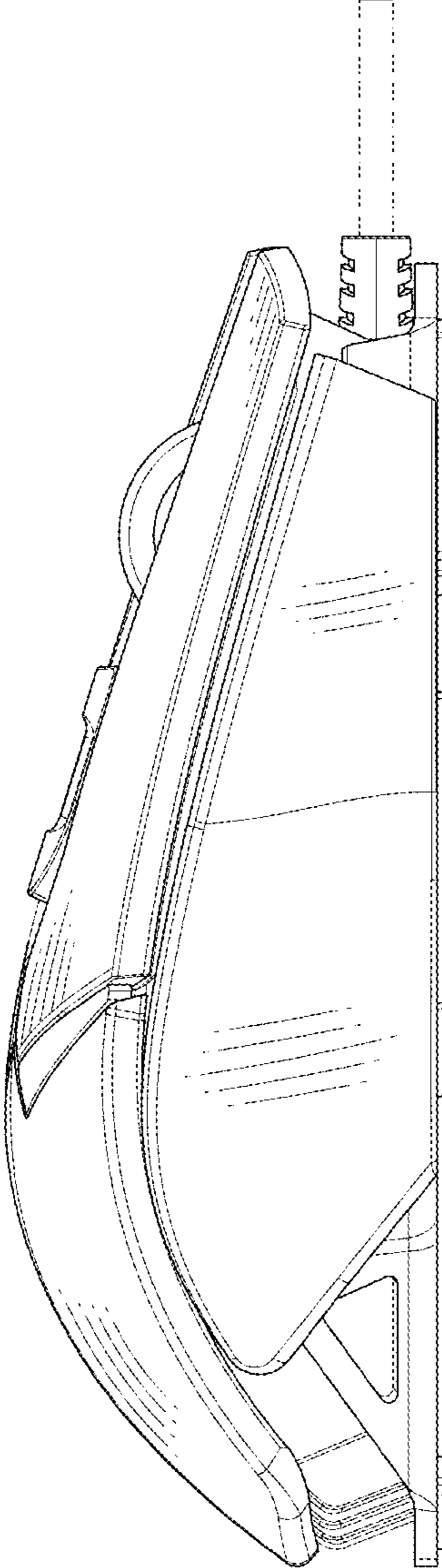

FIG.5

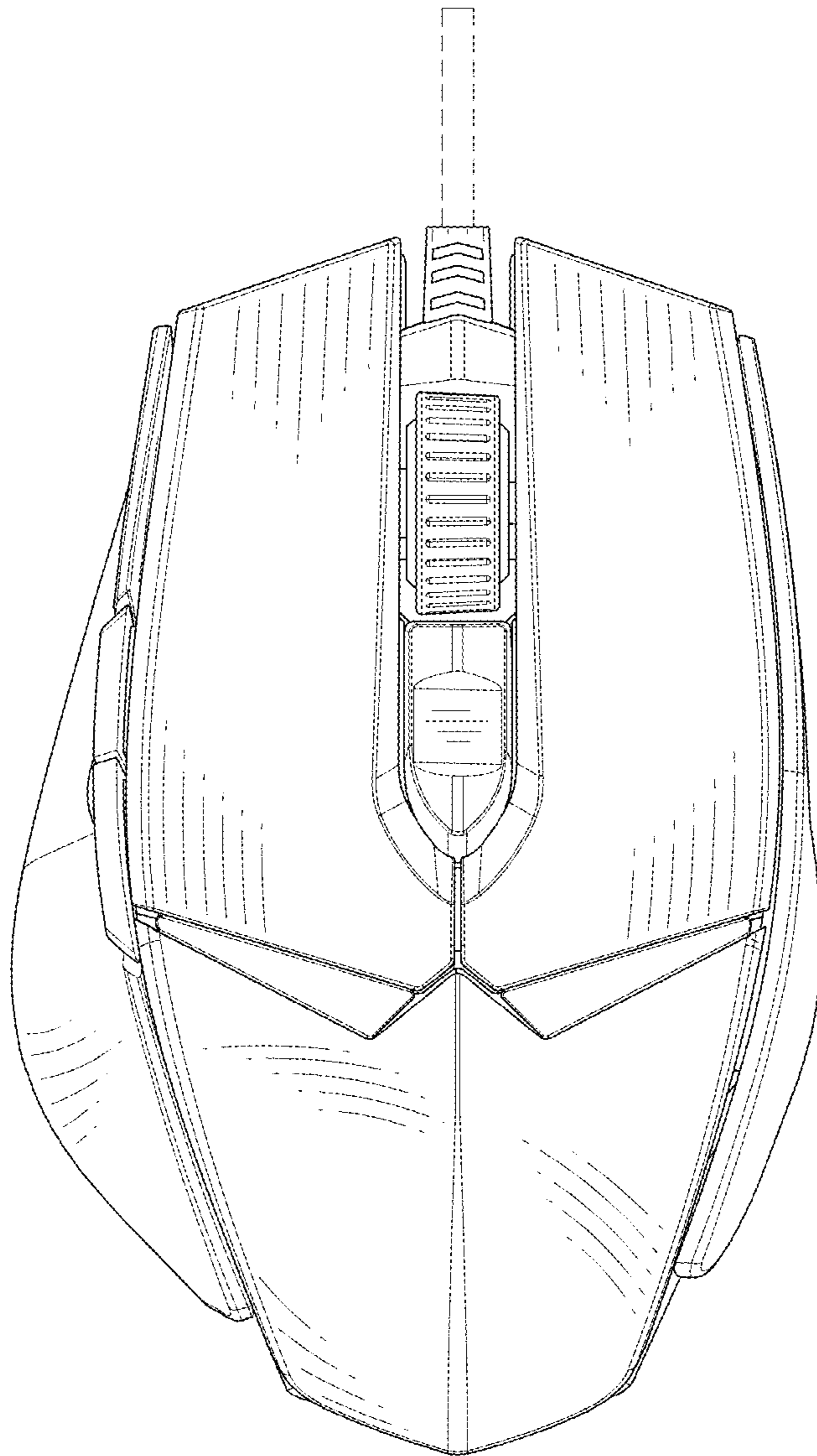

FIG.6

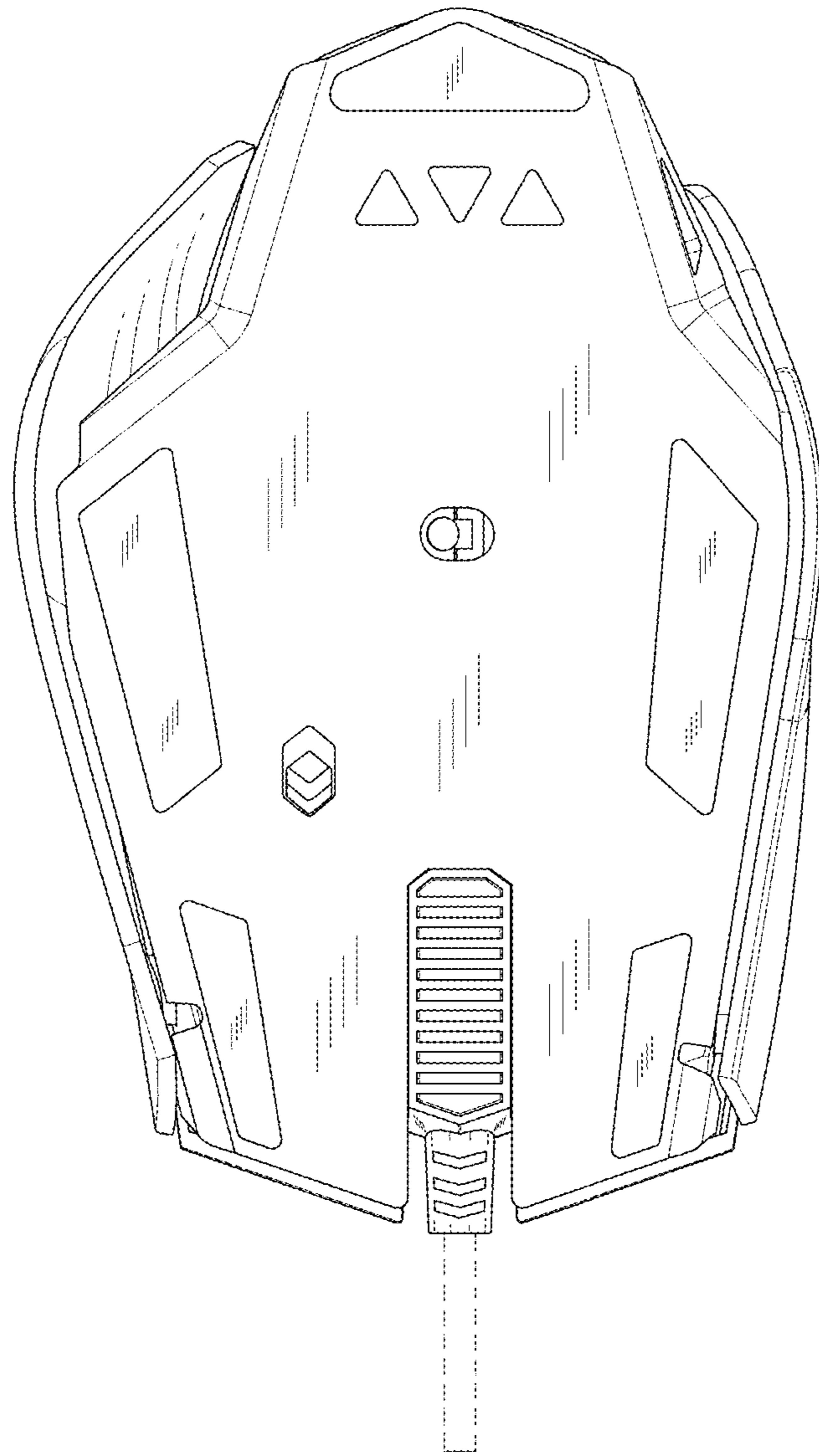

FIG. 7