



US00D821343S

(12) **United States Design Patent**  
**Won et al.**

(10) **Patent No.:** **US D821,343 S**  
(45) **Date of Patent:** **\*\* Jun. 26, 2018**

(54) **TV RECEIVER**

*Primary Examiner* — Michael A. Pratt

(71) Applicant: **LG ELECTRONICS INC.**, Seoul (KR)

(74) *Attorney, Agent, or Firm* — Birch, Stewart, Kolasch & Birch, LLP

(72) Inventors: **Hyojin Won**, Seoul (KR); **Taeho Kim**, Seoul (KR); **Yongho Lee**, Seoul (KR)

(57) **CLAIM**

(73) Assignee: **LG ELECTRONICS INC.**, Seoul (KR)

The ornamental design for a TV receiver, as shown and described.

(\*\*) Term: **15 Years**

(21) Appl. No.: **35/501,905**

(22) Filed: **May 13, 2016**

**DESCRIPTION**

(80) **Hague Agreement Data**

Int. Filing Date: **May 13, 2016**  
Int. Reg. No.: **DM/091257**  
Int. Reg. Date: **May 13, 2016**  
Int. Reg. Pub. Date: **Nov. 18, 2016**

- 1. TV receiver
- 1.1 : Perspective
- 1.2 : Rear perspective
- 1.3 : Front
- 1.4 : Back
- 1.5 : Left
- 1.6 : Right
- 1.7 : Top
- 1.8 : Bottom
- 1.9 : Perspective
- 1.10 : Rear perspective
- 1.11 : Front
- 1.12 : Back
- 1.13 : Left
- 1.14 : Right
- 1.15 : Top
- 1.16 : Bottom
- 1.17 : Reference

(30) **Foreign Application Priority Data**

Nov. 23, 2015 (KR) ..... 30-2015-0058926

(51) **LOC (11) Cl.** ..... **14-03**

(52) **U.S. Cl.**  
USPC ..... **D14/126**

(58) **Field of Classification Search**  
USPC ..... D14/126, 127, 128, 336, 448  
CPC ... G06F 1/1601; G06F 1/1643; H05K 5/0004;  
H05K 5/0017; H05K 5/02; H05K 5/0217  
See application file for complete search history.

(56) **References Cited**

**U.S. PATENT DOCUMENTS**

D722,033 S \* 2/2015 Kim ..... D14/126

The broken line shown in figure 1.17 is for the purpose of illustrating environment and forms no part of the claimed design.

\* cited by examiner

**1 Claim, 17 Drawing Sheets**

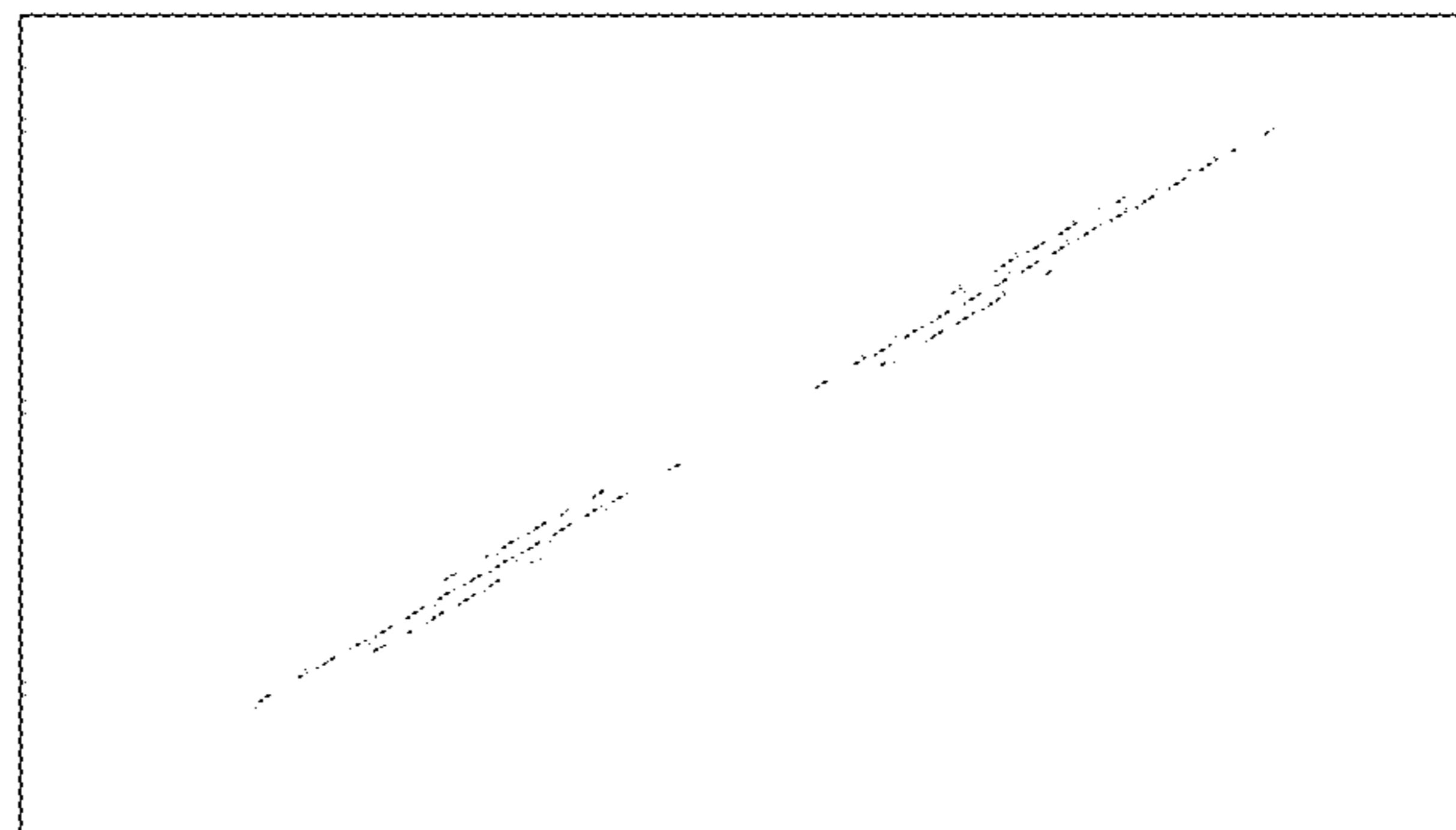
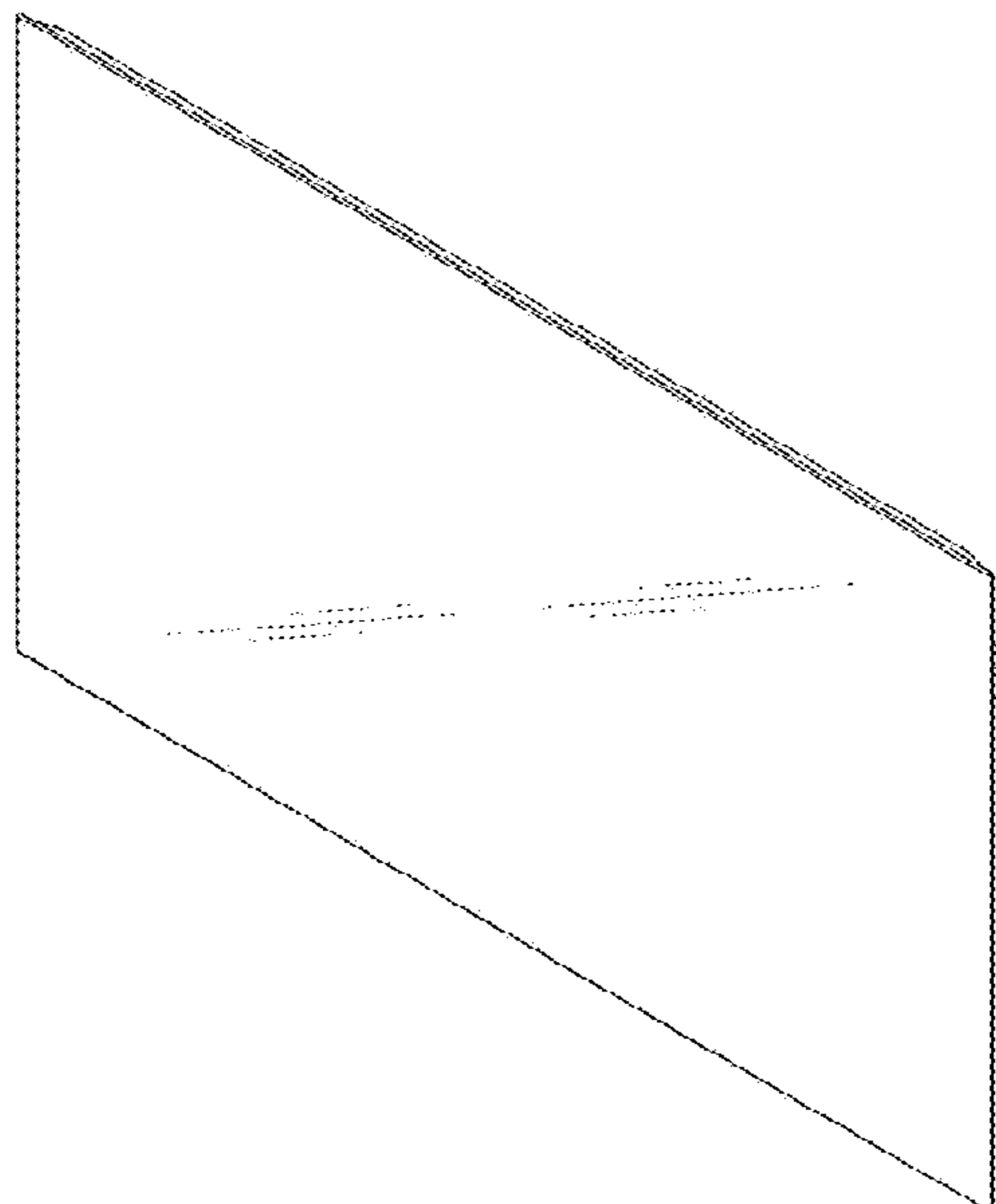

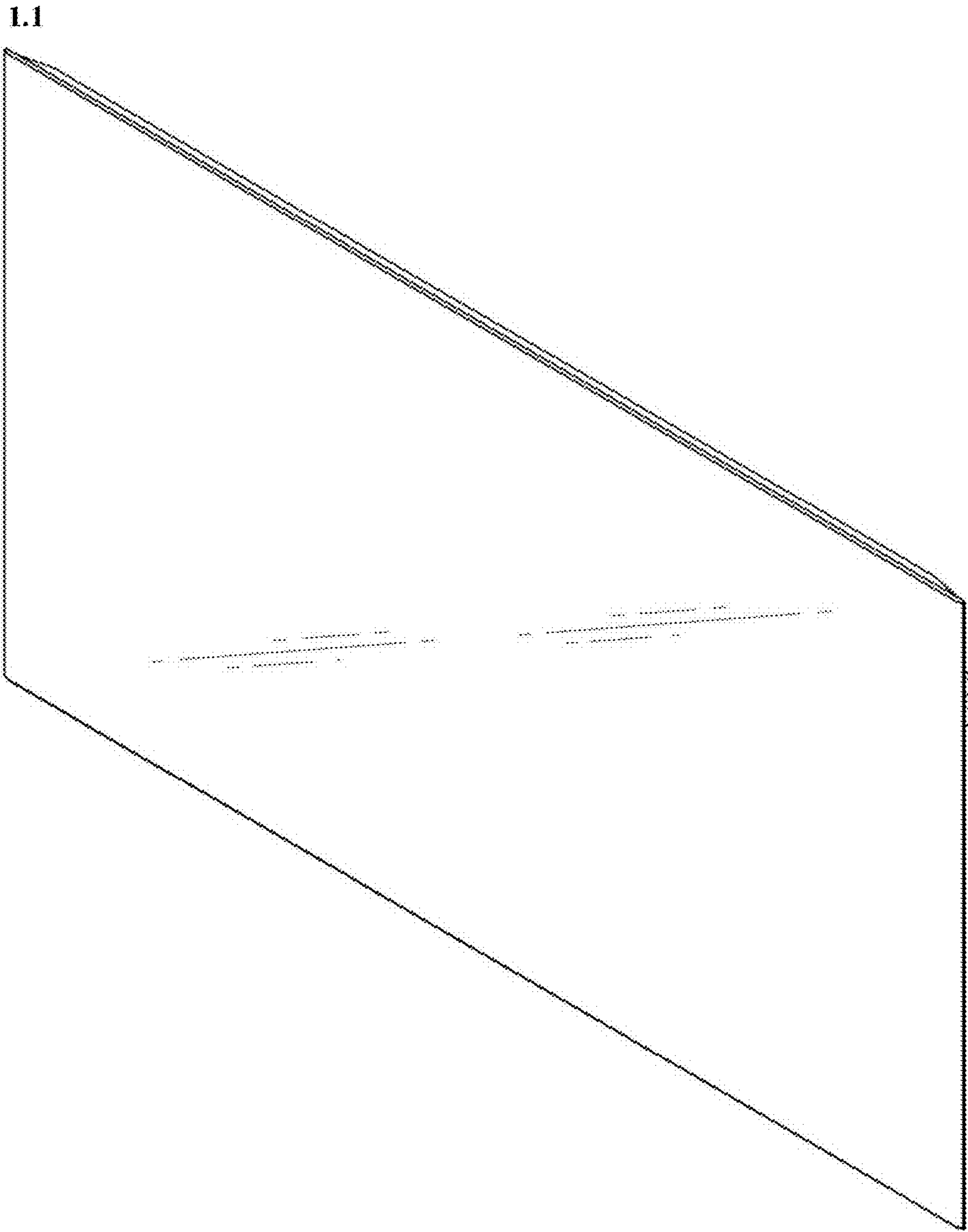

1.2

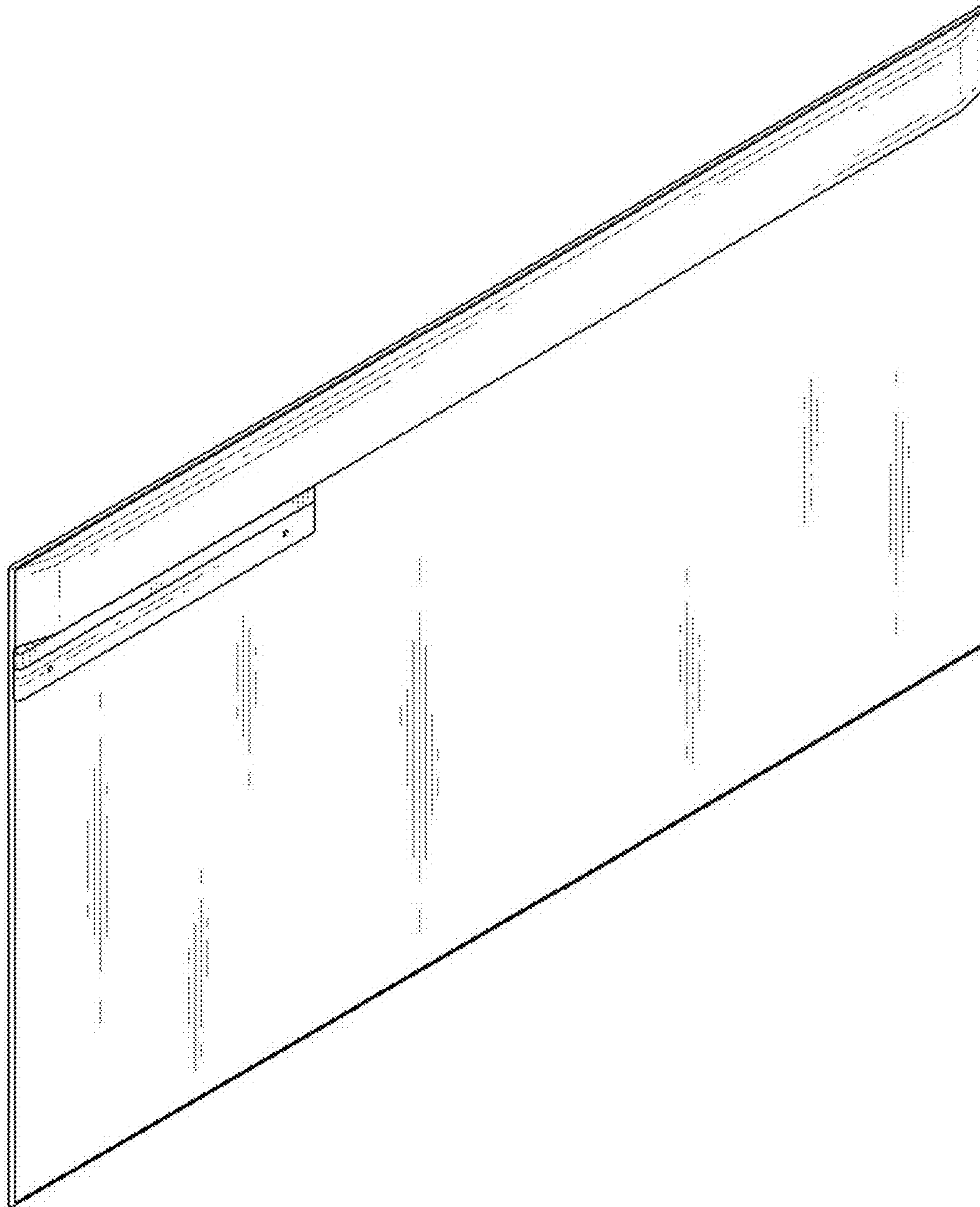

1.3

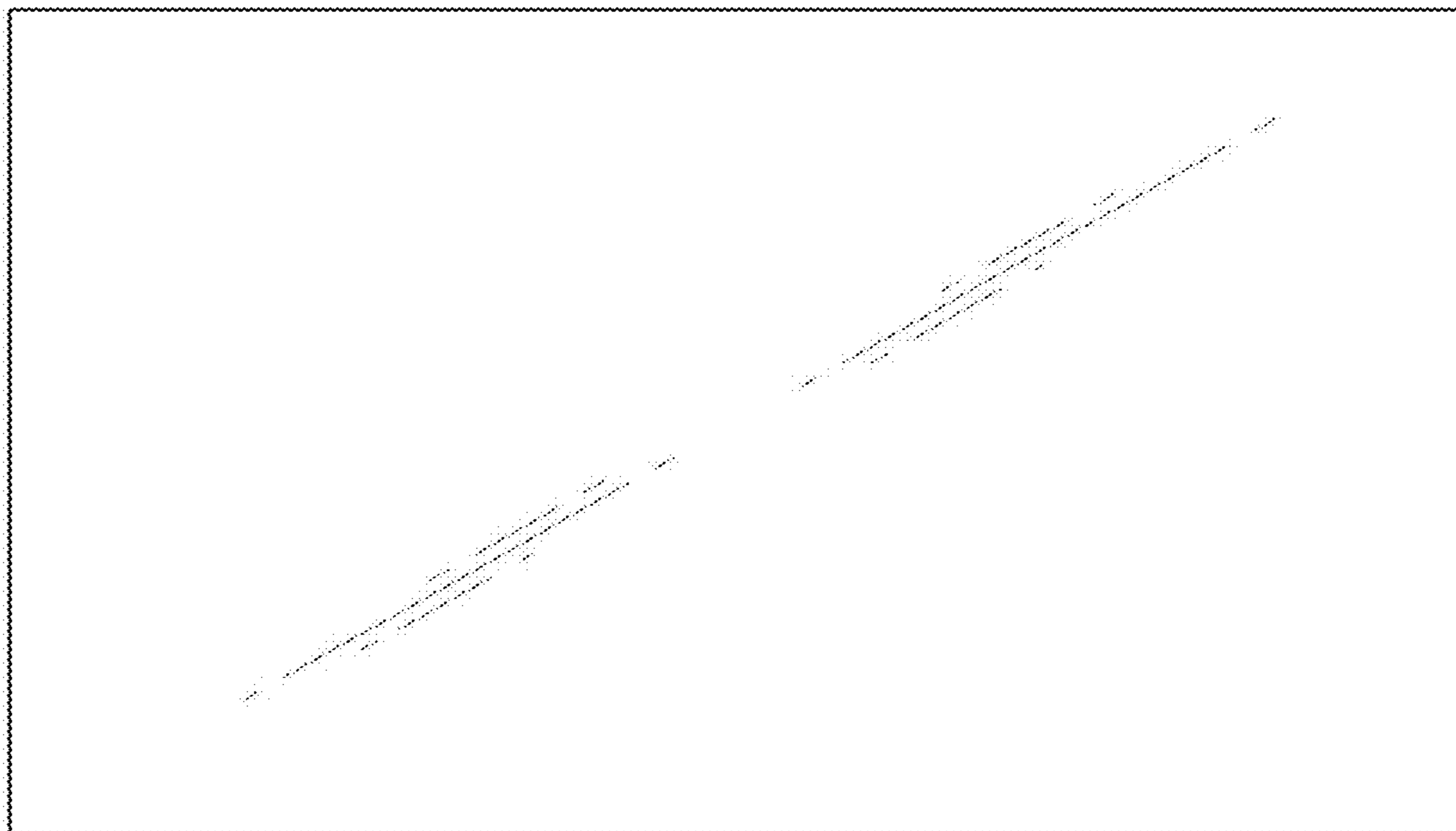

1.4

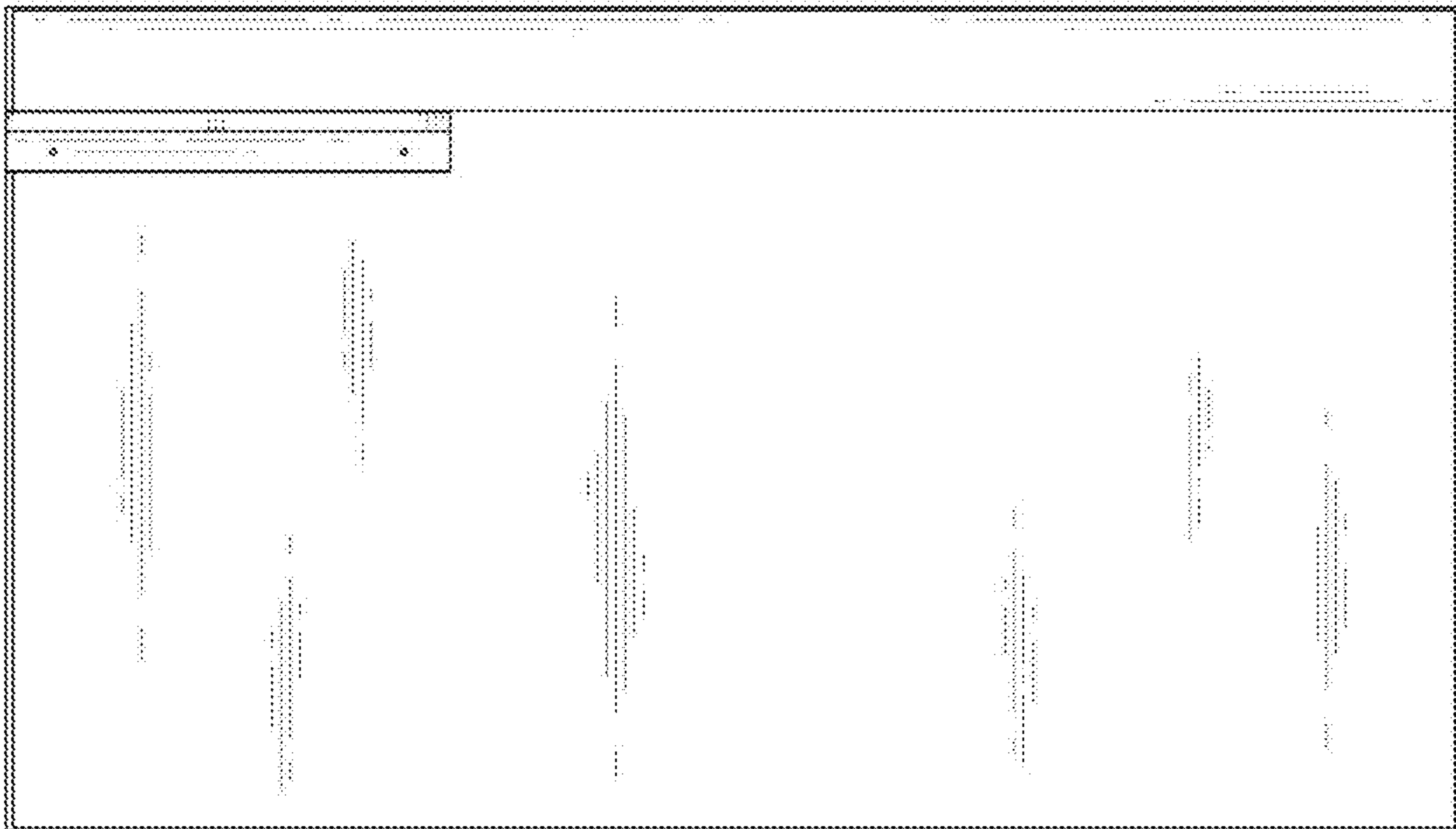

1.5



1.6



1.7

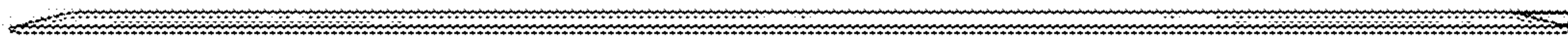



1.8

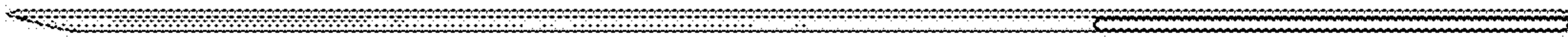

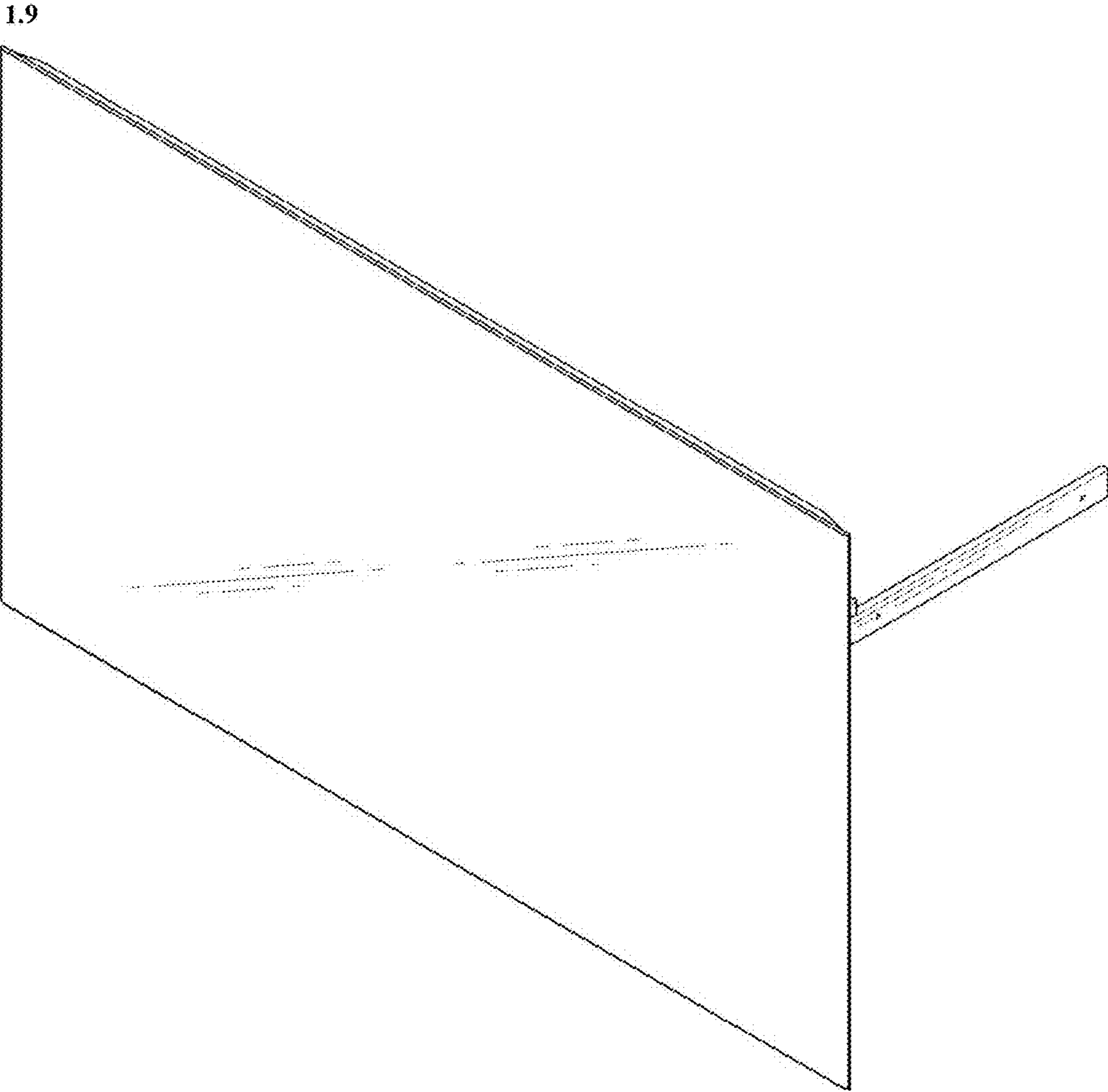

1.10

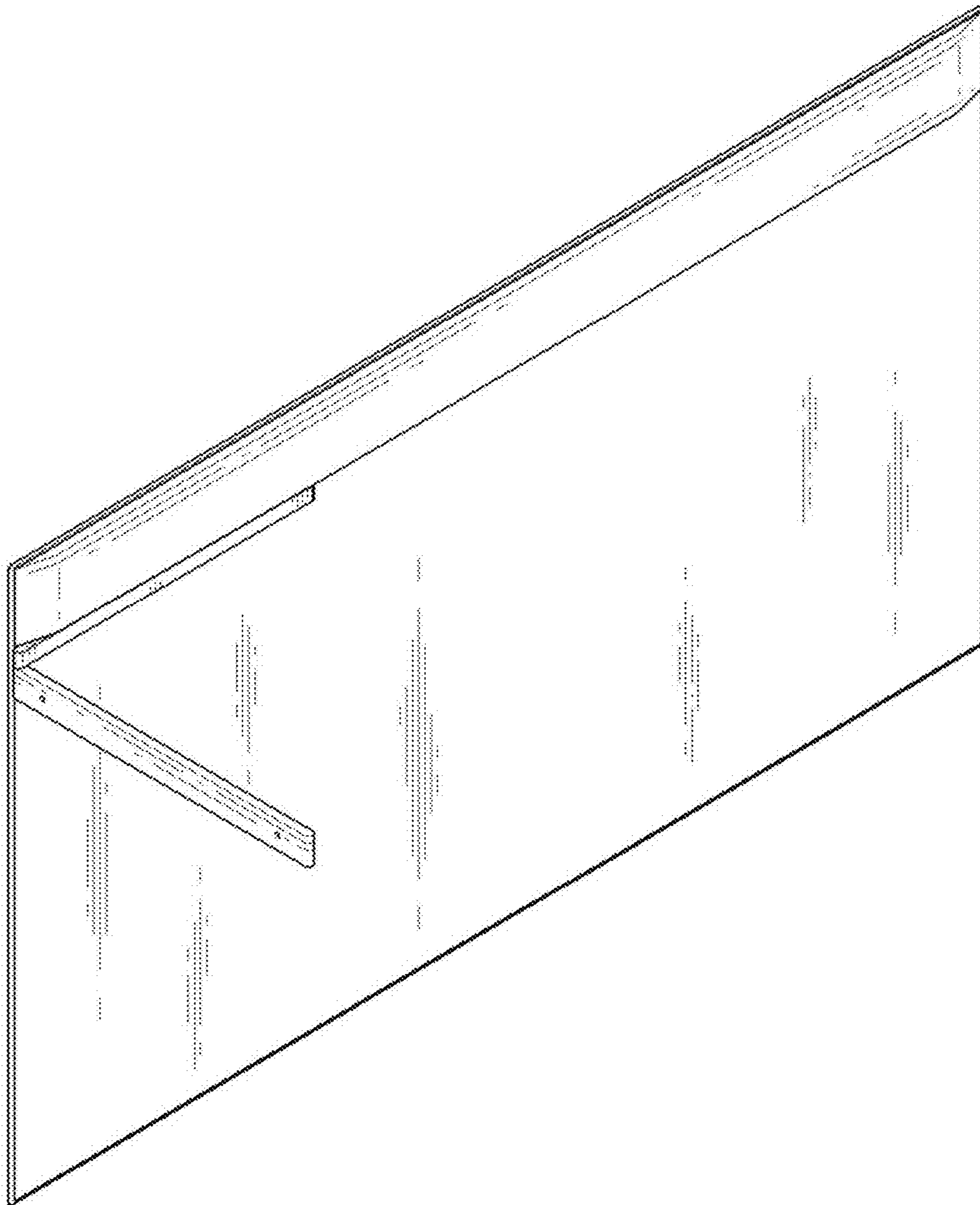

1.11

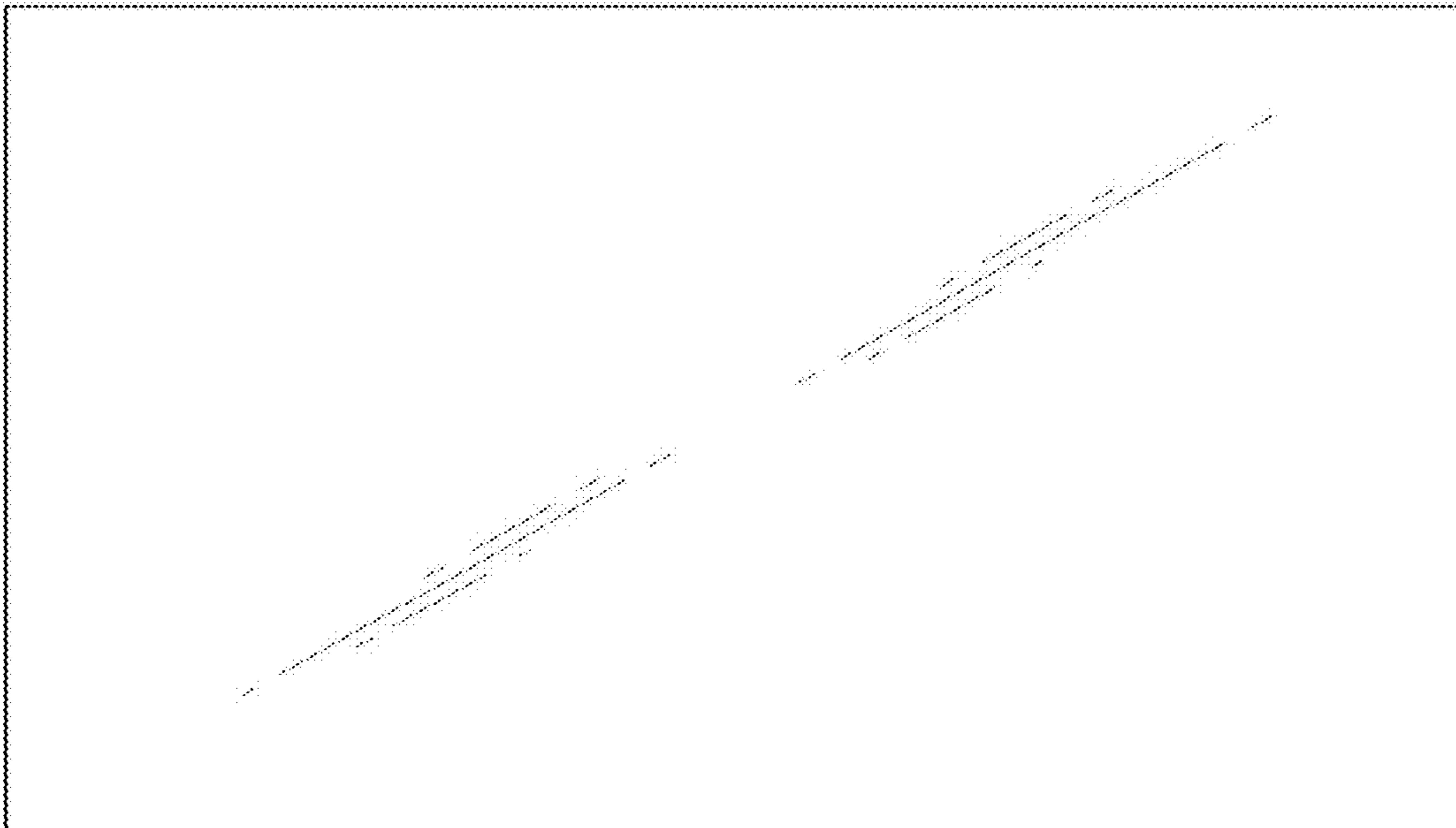

1.12

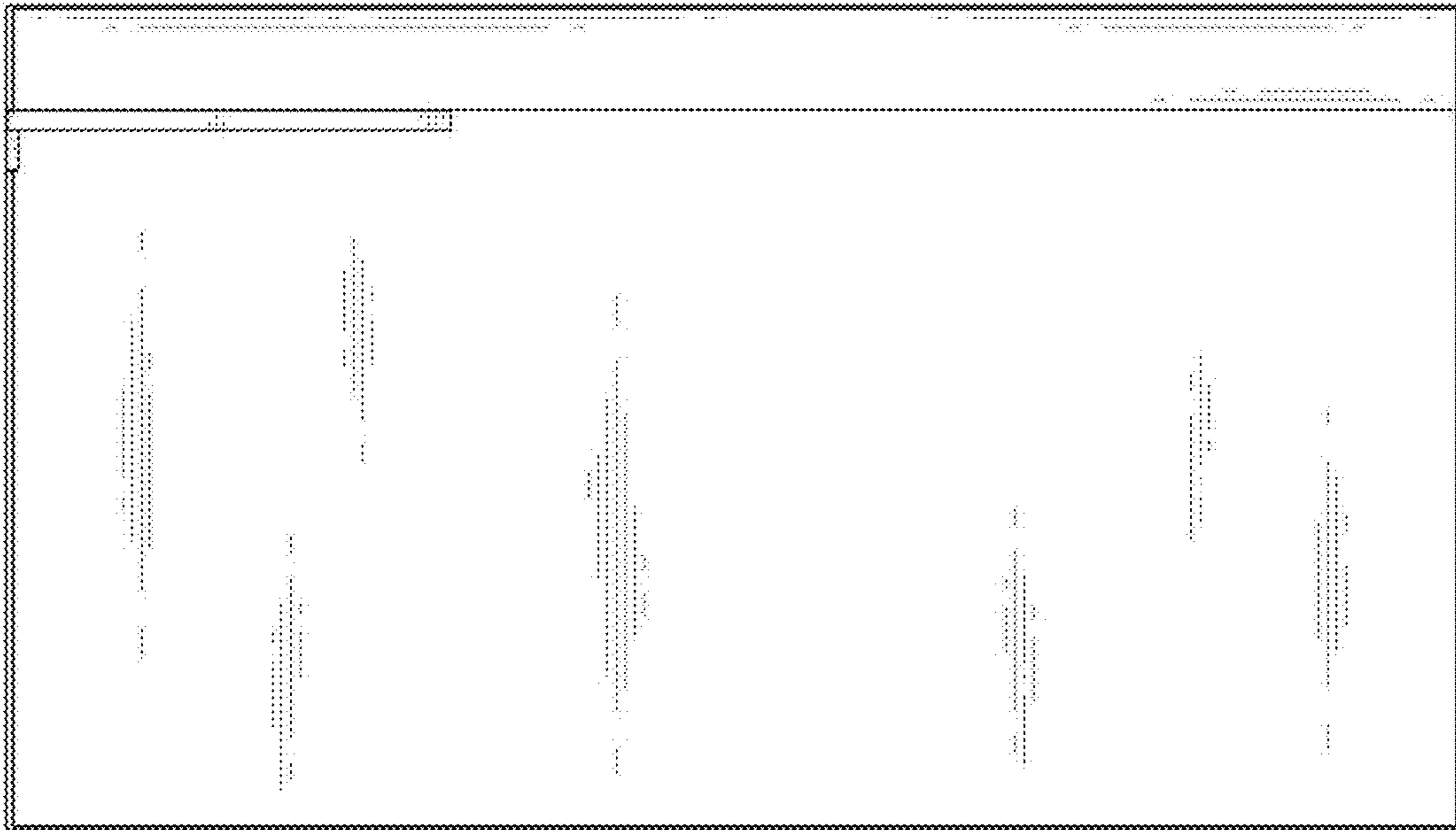

1.13



1.14

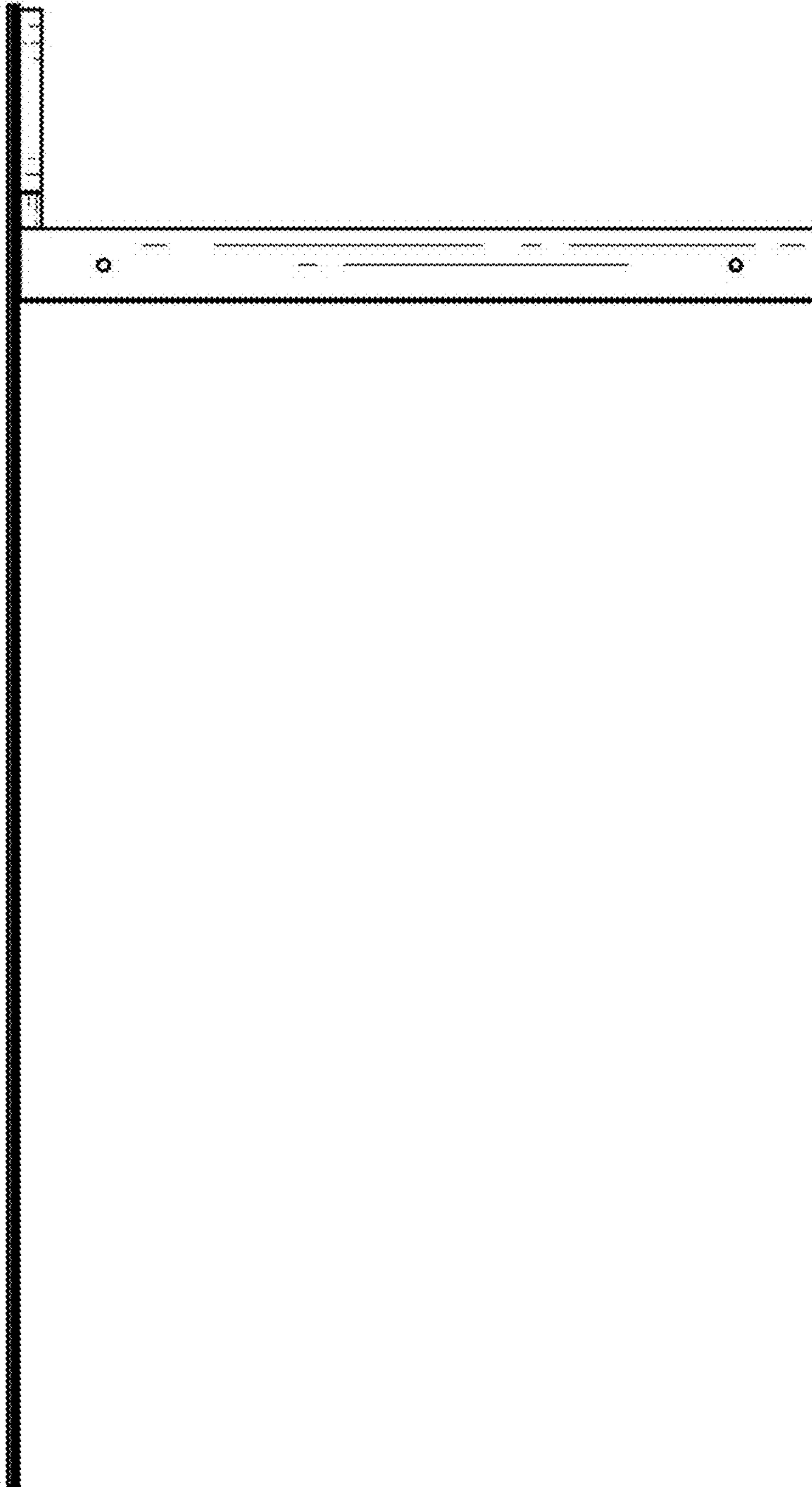

1.15





1.16



1.17

