



US00D821341S

(12) **United States Design Patent**
Iseki et al.

(10) **Patent No.:** **US D821,341 S**
(45) **Date of Patent:** **** Jun. 26, 2018**

- (54) **DISPLAY**
- (71) Applicant: **Sony Corporation**, Tokyo (JP)
- (72) Inventors: **Daisuke Iseki**, Tokyo (JP); **Naoki Ogishita**, Tokyo (JP)
- (73) Assignee: **SONY CORPORATION**, Tokyo (JP)
- (**) Term: **15 Years**
- (21) Appl. No.: **29/545,804**
- (22) Filed: **Nov. 16, 2015**

- D601,143 S 9/2009 Oikawa et al.
 - D611,918 S 3/2010 Shih et al.
 - D615,513 S 5/2010 Yamaguchi et al.
- (Continued)

Primary Examiner — George D. Kirschbaum
Assistant Examiner — Clese Moore, Jr.
 (74) *Attorney, Agent, or Firm* — Michael Best and Friedrich LLP

(57) **CLAIM**

The ornamental design for a display, as shown and described.

DESCRIPTION

FIG. 1 is a front, top, right perspective view of a display showing our new design;
 FIG. 2 is a rear, top, right perspective view thereof;
 FIG. 3 is a front elevational view thereof;
 FIG. 4 is a left side elevational view thereof;
 FIG. 5 is a right side elevational view thereof; and
 FIG. 6 is a top plan view thereof; and
 FIG. 7 is a bottom plan view thereof.
 FIG. 8 is a front, top, right perspective view of a display showing our new design;
 FIG. 9 is a rear, top, right perspective view thereof;
 FIG. 10 is a front elevational view thereof;
 FIG. 11 is a left side elevational view thereof;
 FIG. 12 is a right side elevational view thereof;
 FIG. 13 is a top plan view thereof; and
 FIG. 14 is a bottom plan view thereof.
 FIG. 15 is a front, top, right perspective view of a display showing our new design;
 FIG. 16 is a rear, top, right perspective view thereof;
 FIG. 17 is a front elevational view thereof;
 FIG. 18 is a left side elevational view thereof;
 FIG. 19 is a right side elevational view thereof;
 FIG. 20 is a top plan view thereof; and
 FIG. 21 is a bottom plan view thereof.
 The broken lines showing of parts of the display form no part of the claimed design.

Related U.S. Application Data

- (63) Continuation-in-part of application No. 29/484,726, filed on Mar. 12, 2014, now Pat. No. Des. 743,365.
- (51) **LOC (11) Cl.** **14-03**
- (52) **U.S. Cl.**
USPC **D14/126**
- (58) **Field of Classification Search**
USPC D12/125–134, 239, 371, 374–377, 448,
D12/450, 336, 334, 314; D6/300;
D21/329, 515
CPC G06F 1/1601; G06F 1/1643; G06F
2200/1612
See application file for complete search history.

References Cited

U.S. PATENT DOCUMENTS

- (56) D474,162 S 5/2003 Kubota
- D556,745 S 12/2007 Katagiri et al.
- D570,804 S 6/2008 Fujiki
- D572,676 S * 7/2008 Niitsu D14/126
- D573,117 S * 7/2008 Niitsu D14/126
- D584,258 S * 1/2009 Yang D14/126
- D584,706 S * 1/2009 Yoshimura D14/126
- D594,426 S * 6/2009 Yuuki D14/126
- D600,661 S * 9/2009 Ohki D14/126

1 Claim, 15 Drawing Sheets

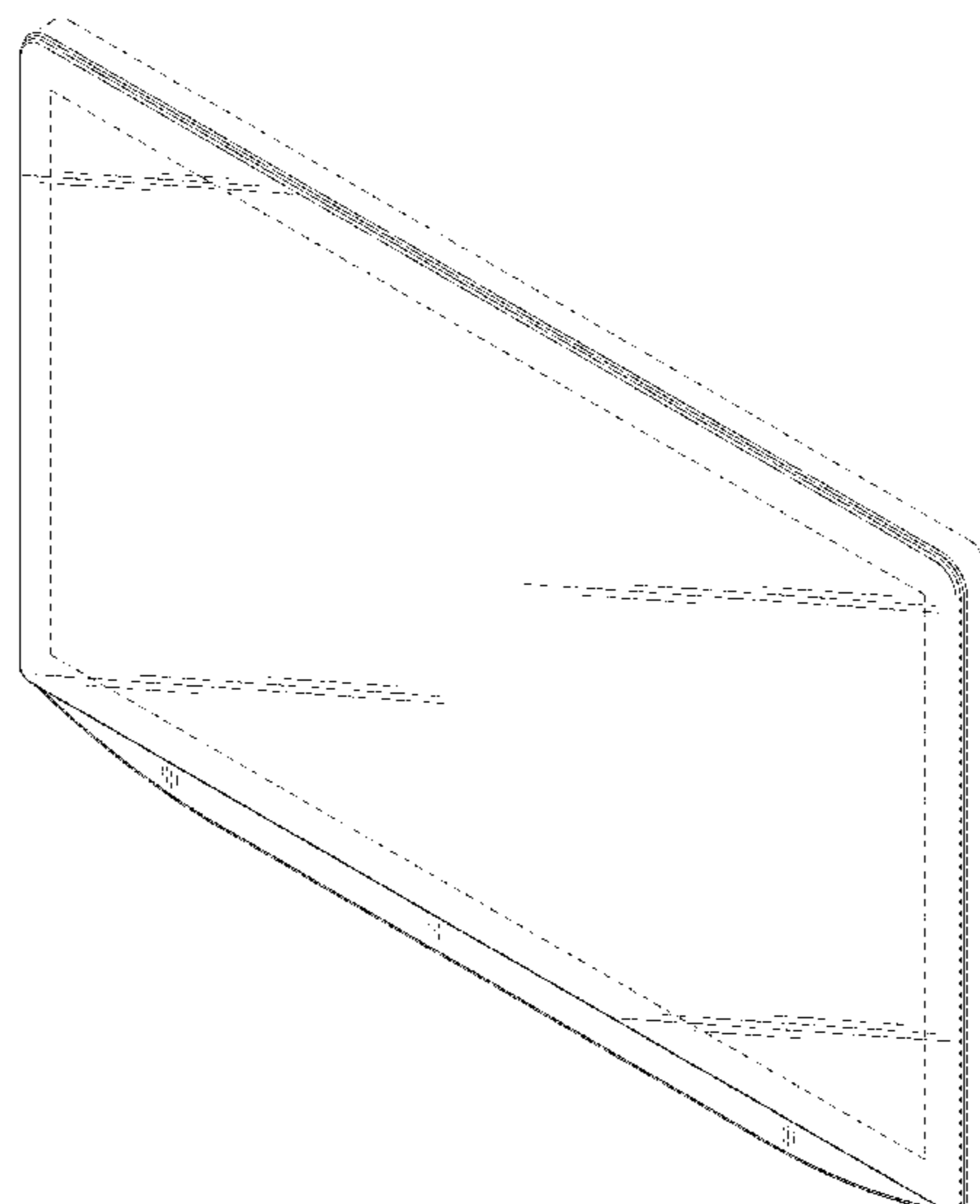

(56)

References Cited

U.S. PATENT DOCUMENTS

D624,891 S 10/2010 Ohba et al.
 D624,892 S * 10/2010 Inoue D14/126
 D626,524 S * 11/2010 Takami D14/126
 D636,769 S 4/2011 Wood et al.
 D642,149 S 7/2011 Inoue et al.
 D642,150 S 7/2011 Takami et al.
 D646,243 S * 10/2011 Honda D14/126
 D656,470 S 3/2012 Kubota et al.
 D656,915 S * 4/2012 Hwangbo D14/126
 D657,326 S * 4/2012 Kim D14/126
 D661,268 S 6/2012 Itou et al.
 D666,565 S 9/2012 Kumano et al.
 D675,583 S 2/2013 Kubota
 D680,087 S 4/2013 Fujii et al.
 D681,576 S 5/2013 Lee et al.
 D682,228 S * 5/2013 Lee D14/126
 D682,231 S * 5/2013 Lee D14/126
 D692,403 S 10/2013 Takami et al.
 D693,343 S * 11/2013 Haller D14/374
 D695,243 S 12/2013 Lewis
 D695,700 S 12/2013 Seong

D700,586 S 5/2014 Kim et al.
 D709,044 S 7/2014 Takami et al.
 D709,045 S 7/2014 Itou et al.
 D709,844 S 7/2014 Kim et al.
 D714,746 S 10/2014 Euseok et al.
 D715,237 S 10/2014 Jang et al.
 D715,244 S * 10/2014 Jang D14/126
 D715,754 S 10/2014 Jang et al.
 D718,731 S 12/2014 Lee et al.
 D719,118 S 12/2014 Kim et al.
 D722,579 S 2/2015 Yagi
 D722,986 S 2/2015 Zwier et al.
 D722,988 S 2/2015 Kim et al.
 D723,482 S 3/2015 Kim et al.
 D725,060 S 3/2015 Lam et al.
 D725,615 S 3/2015 Go et al.
 D725,617 S 3/2015 Choi
 D725,618 S * 3/2015 Shin D14/126
 D741,277 S * 10/2015 Shin D14/126
 D743,365 S * 11/2015 Iseki D14/126
 D744,437 S * 12/2015 Lu D14/126
 D744,440 S * 12/2015 Shin D14/126
 D744,441 S * 12/2015 Shin D14/126

* cited by examiner

FIG.1

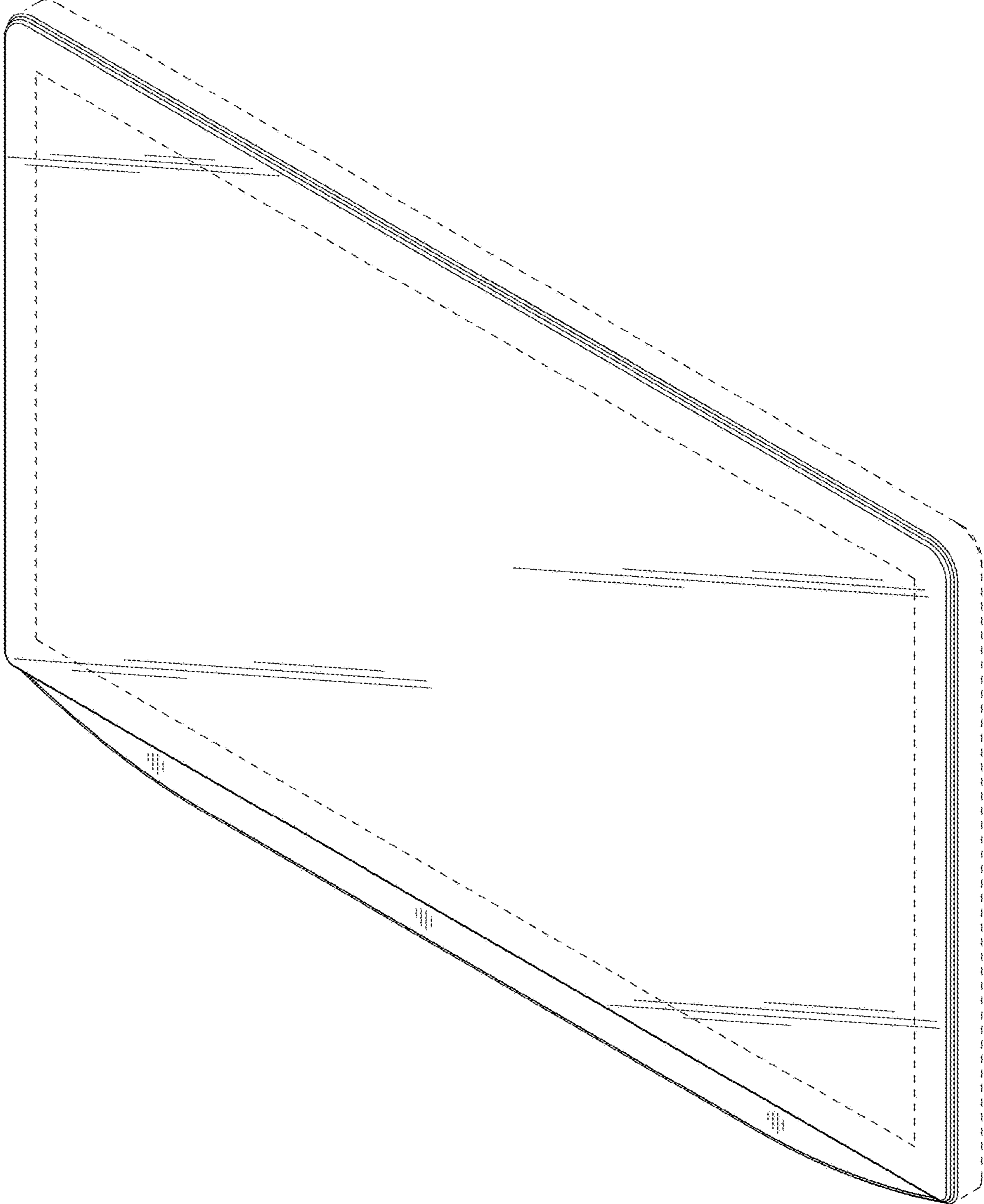

FIG.2

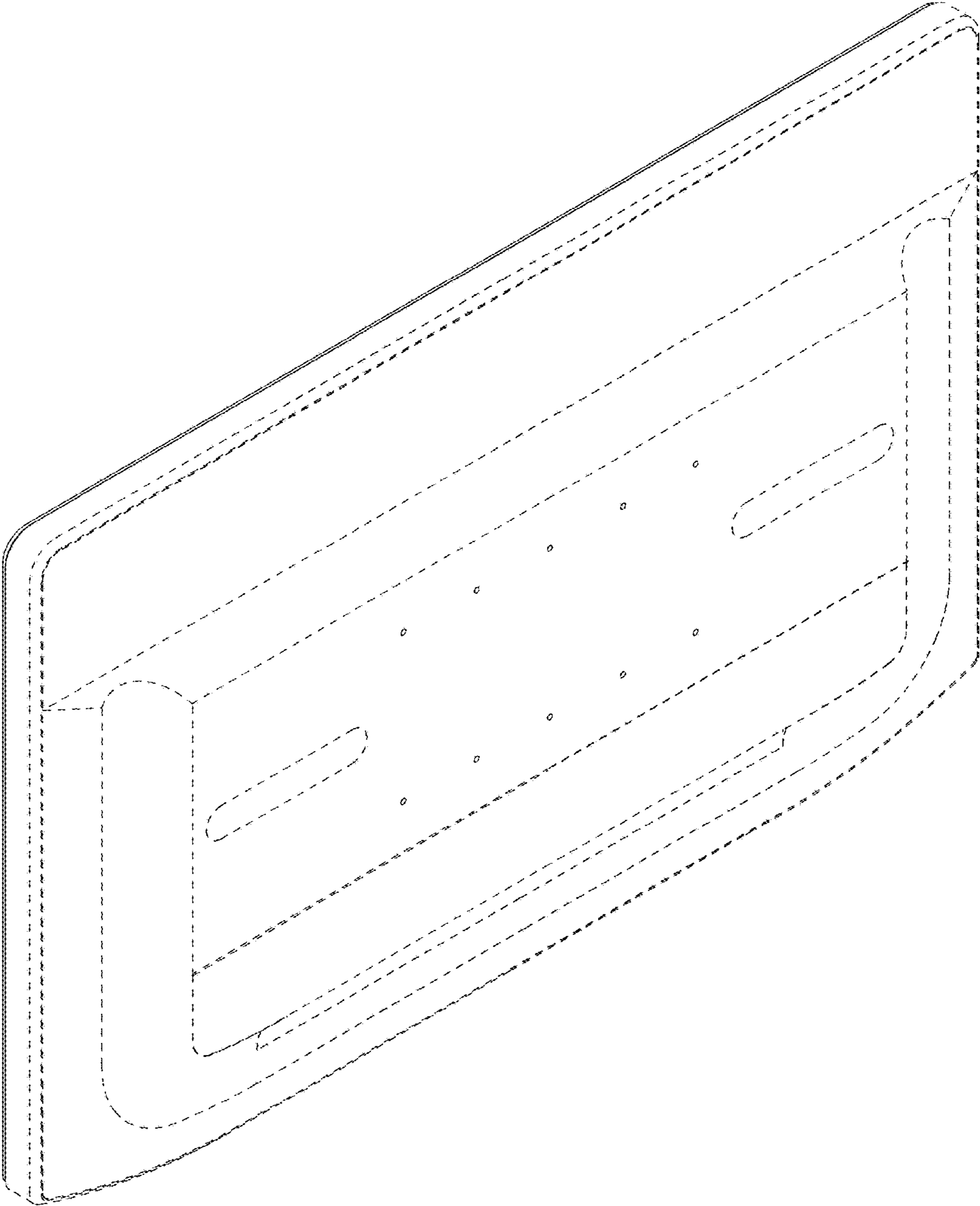

FIG.3

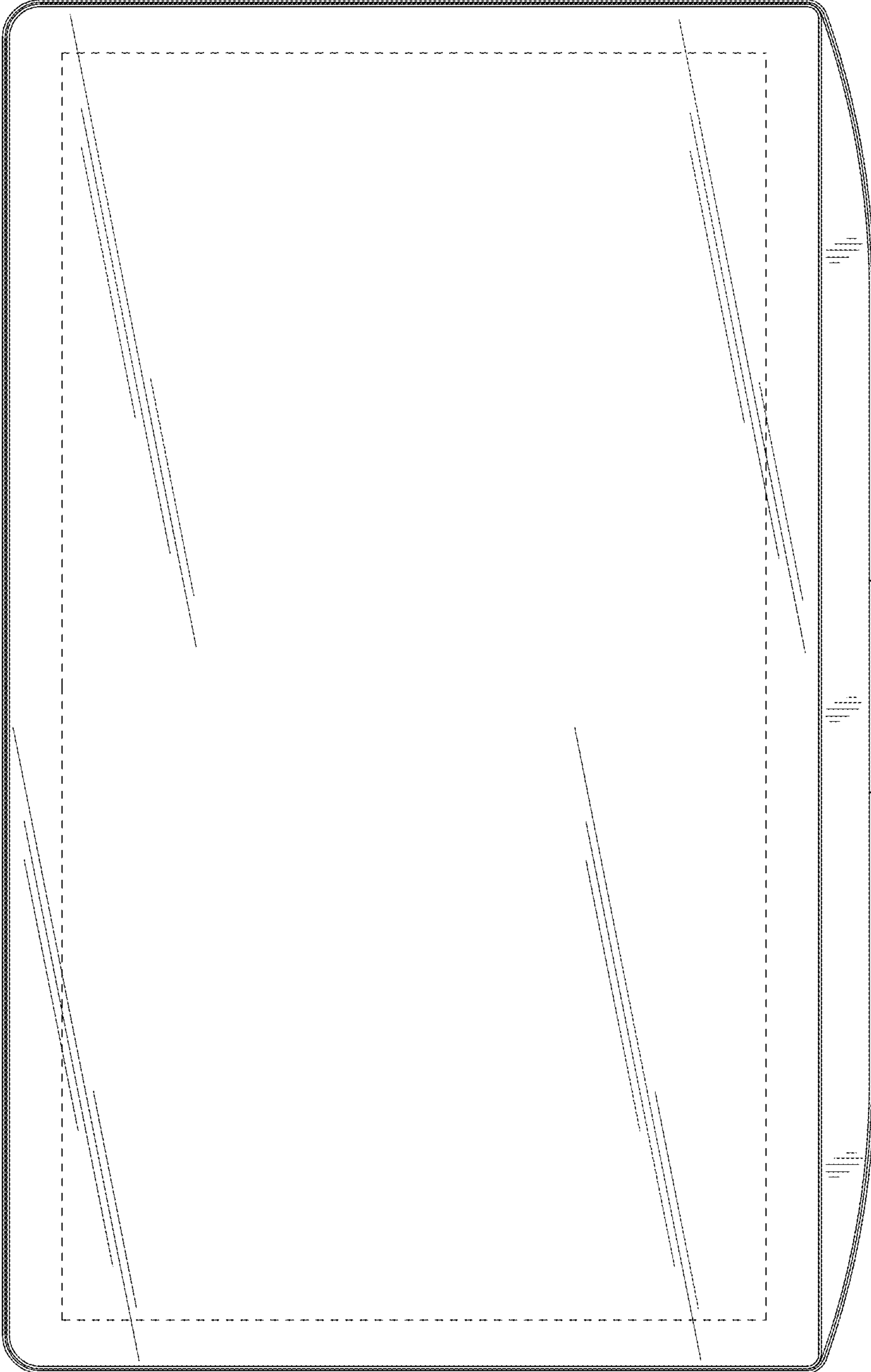

FIG.4

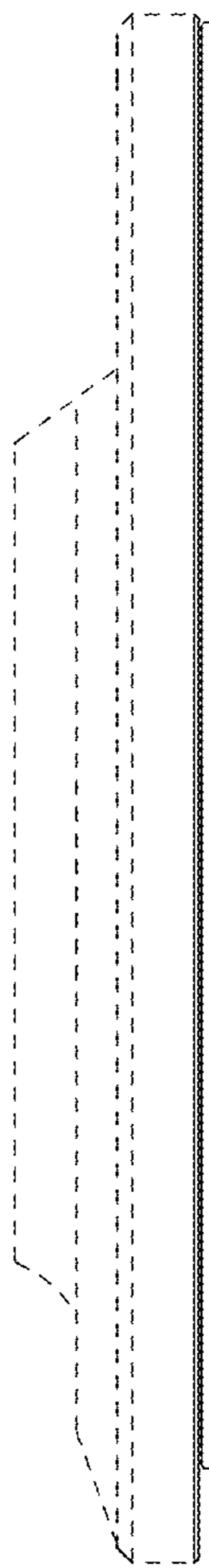

FIG.5

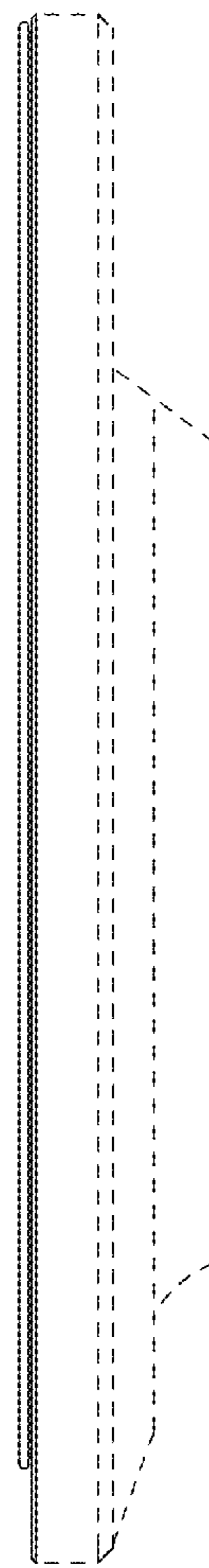

FIG.6

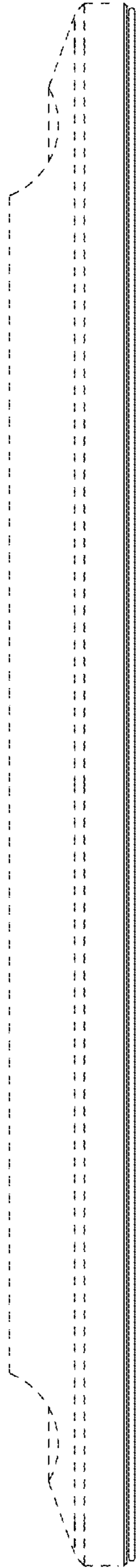

FIG.7

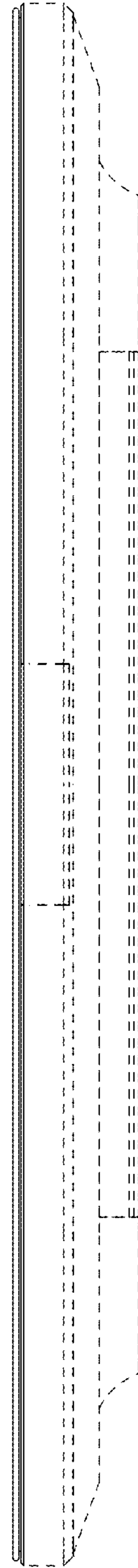

FIG.8

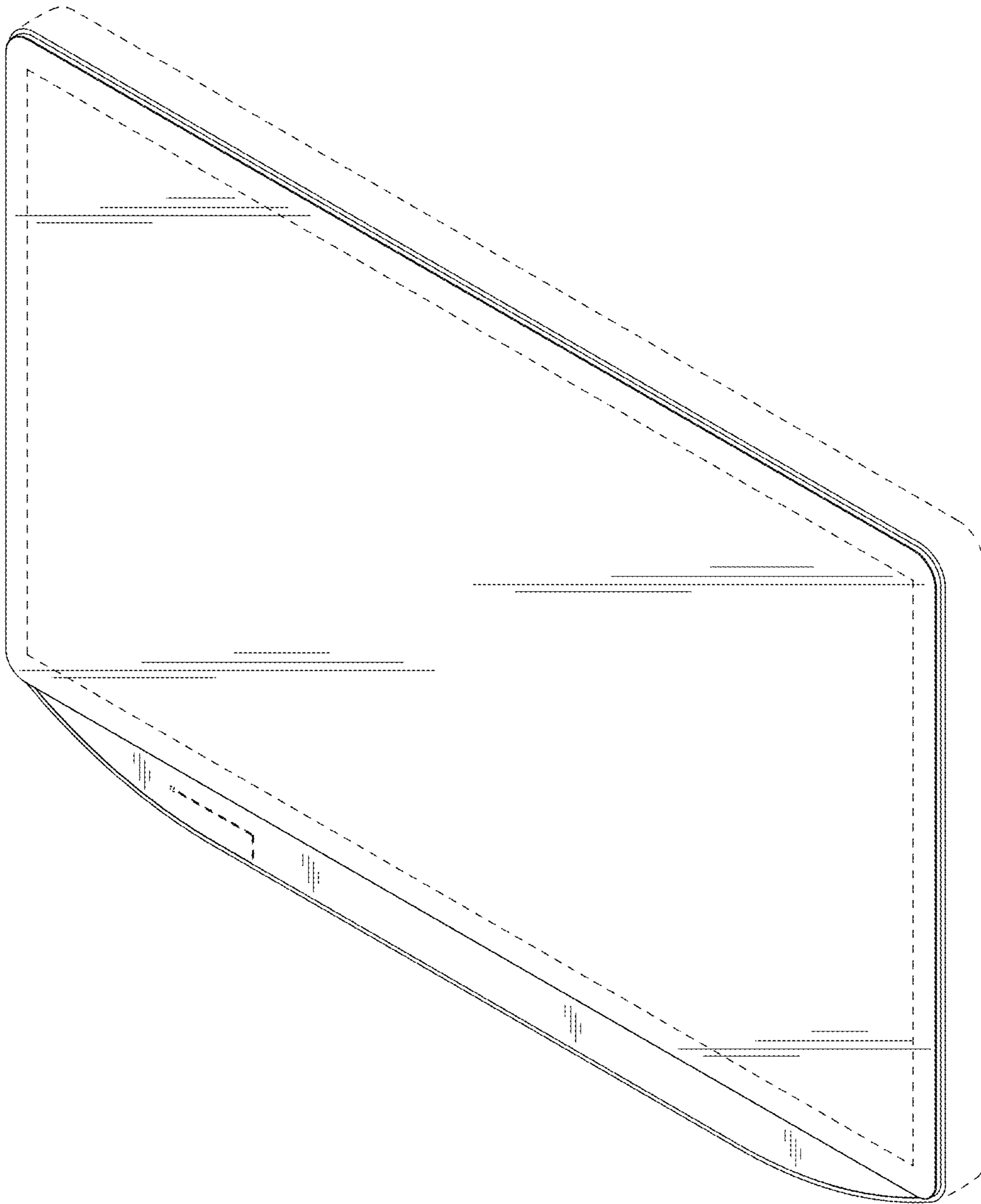

FIG.9

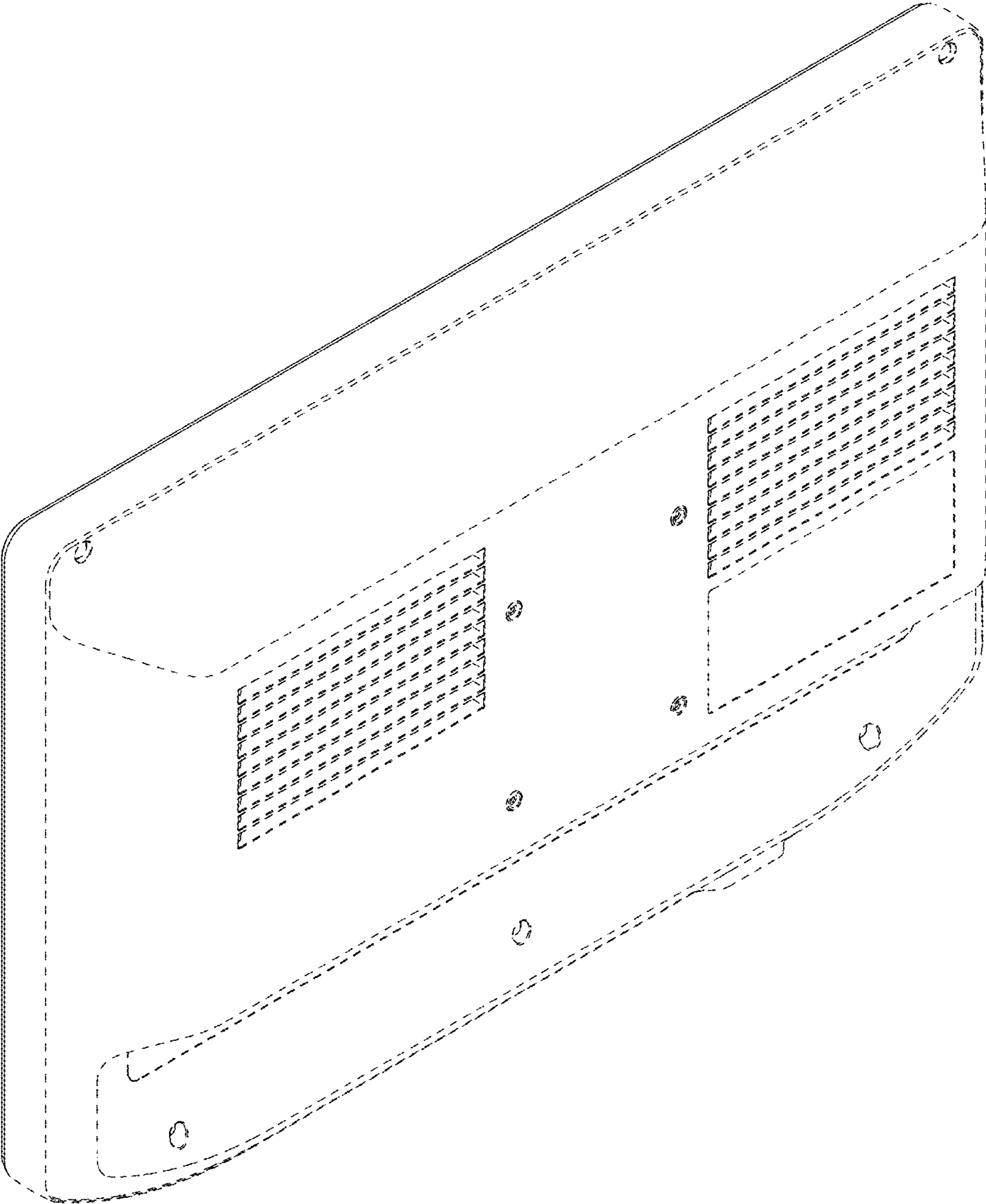

FIG.10

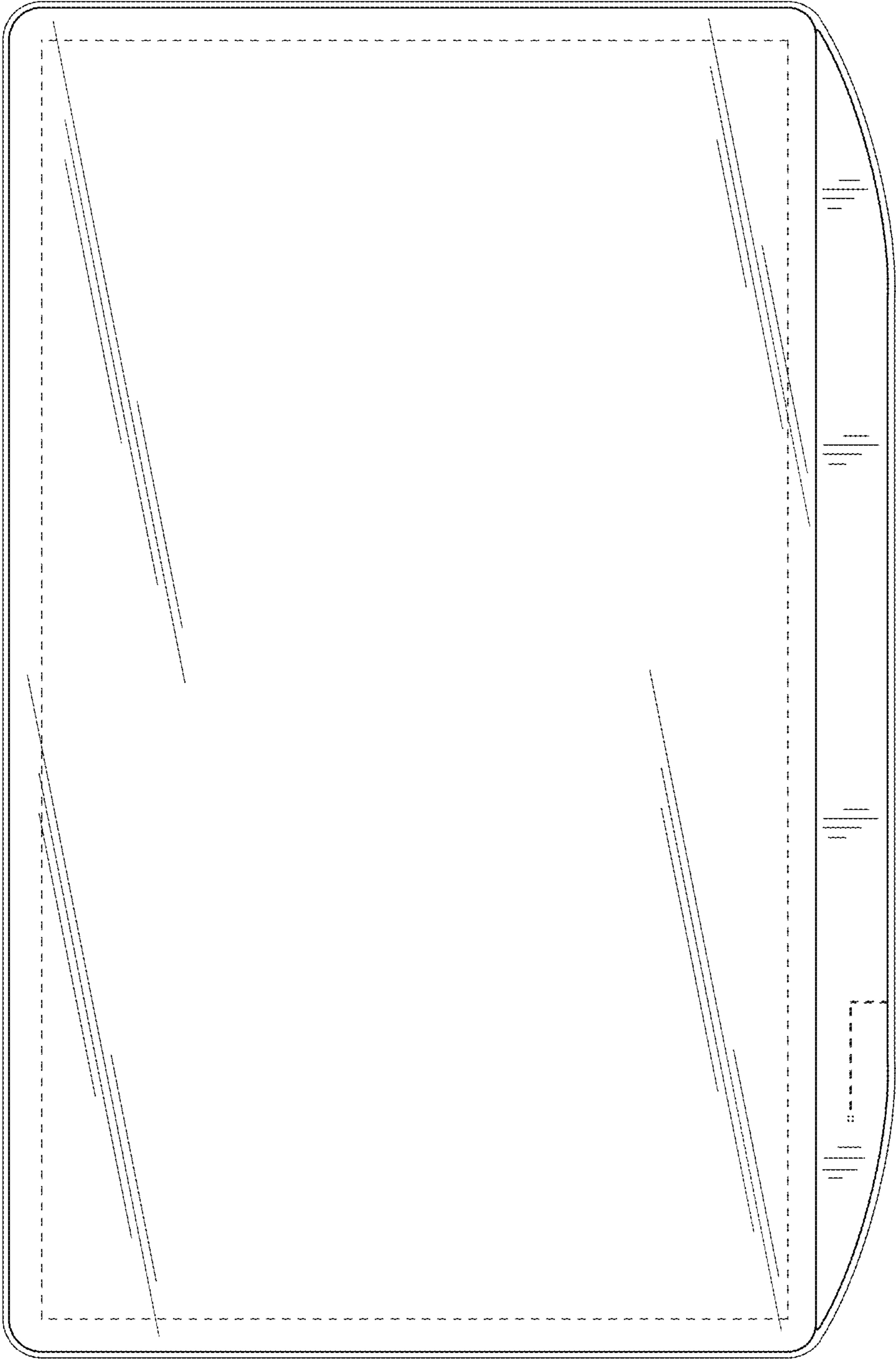

FIG.11

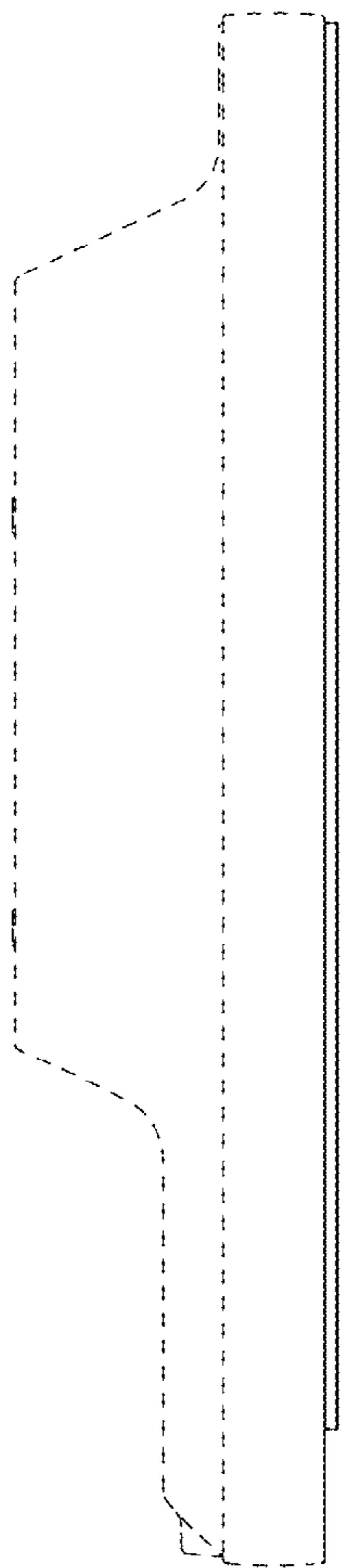

FIG.12

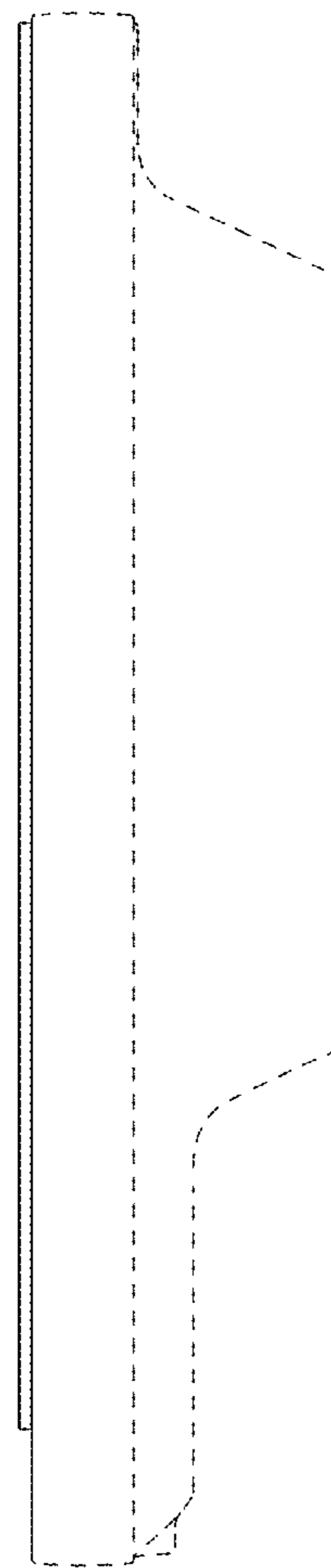

FIG.13

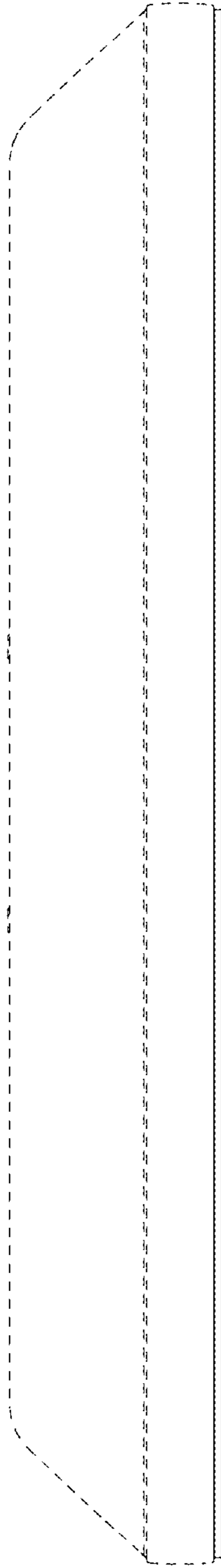

FIG.14

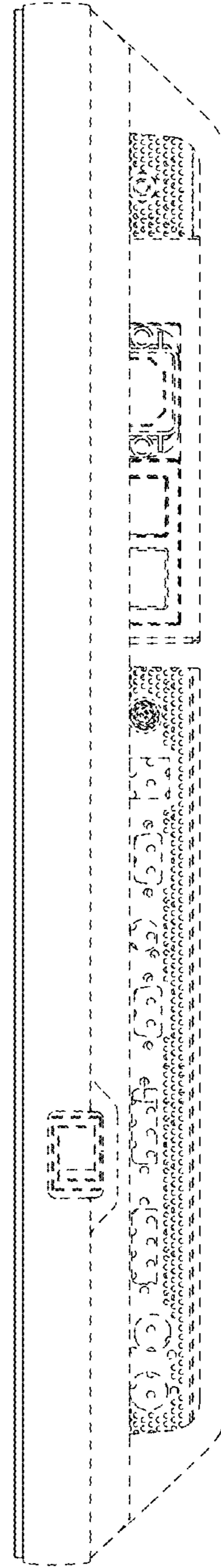

FIG.15

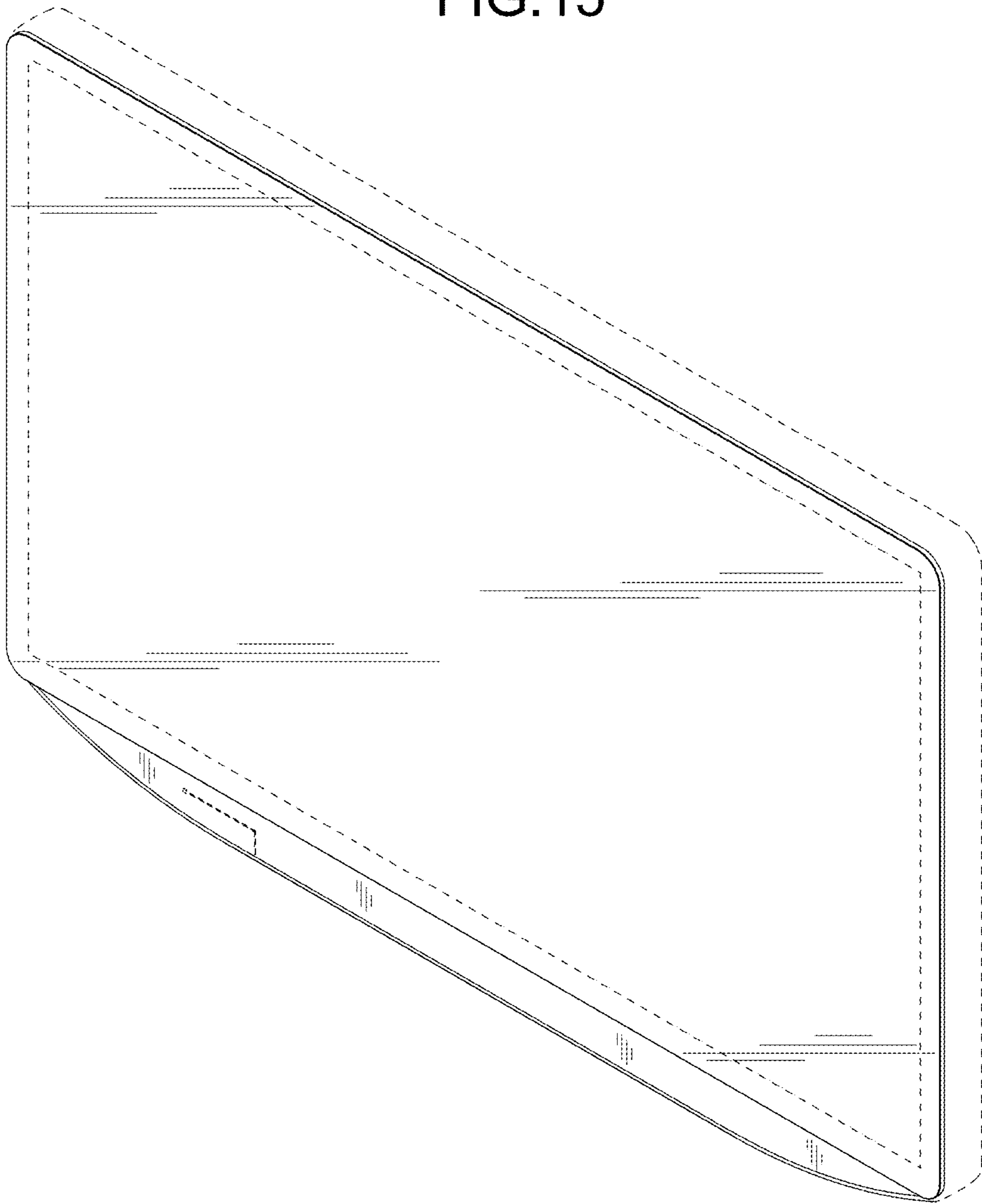

FIG.16

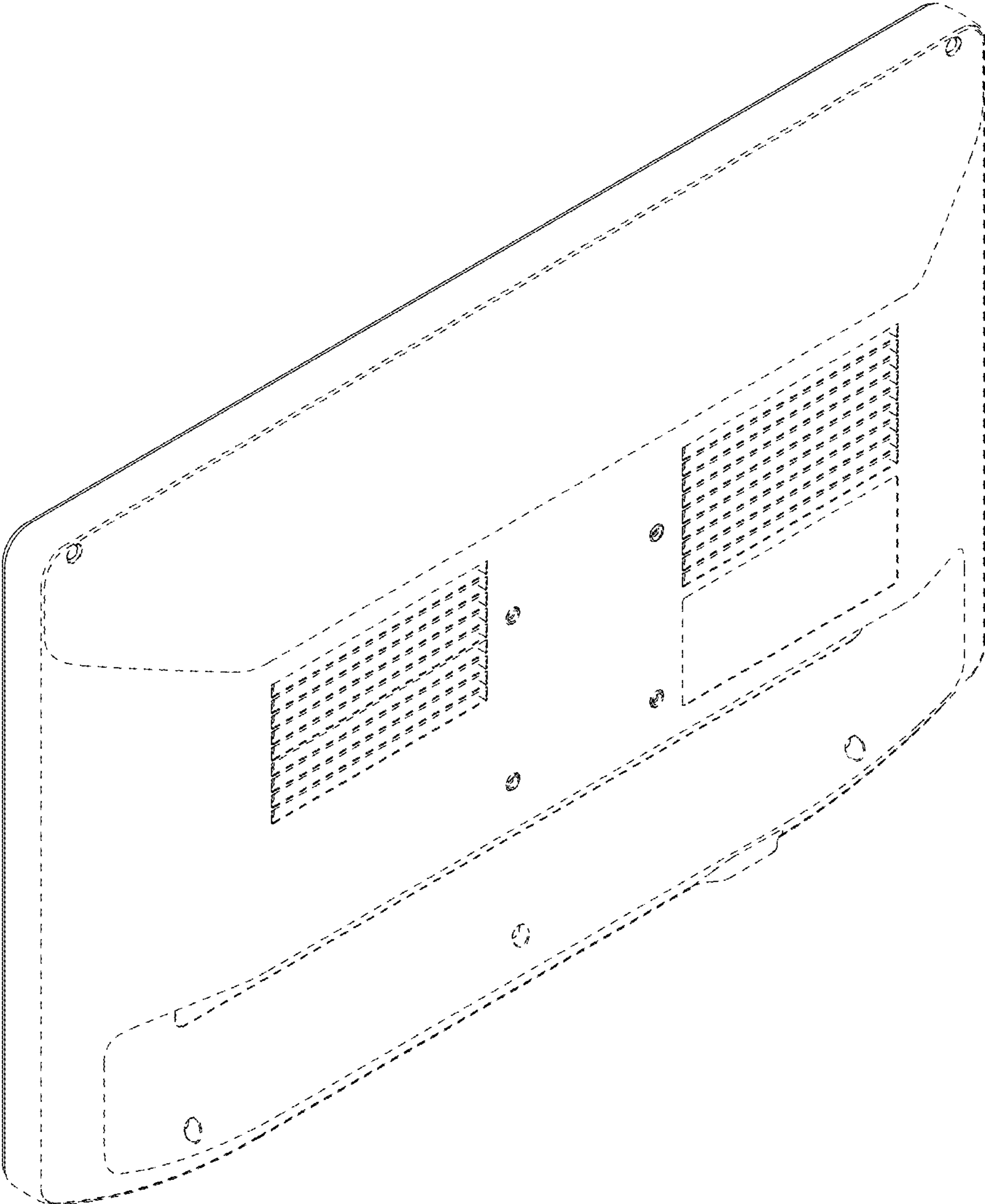

FIG.17

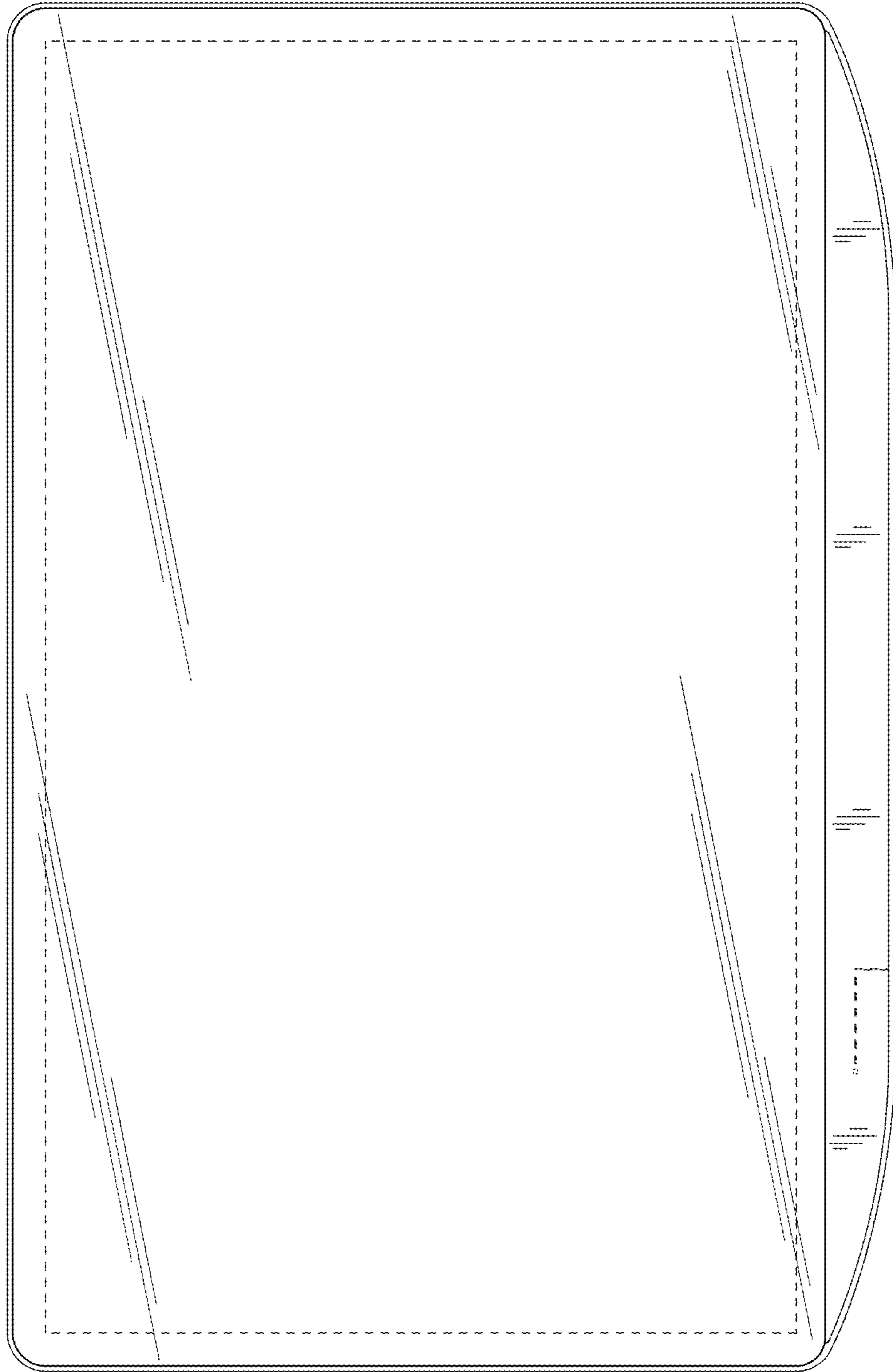

FIG.18

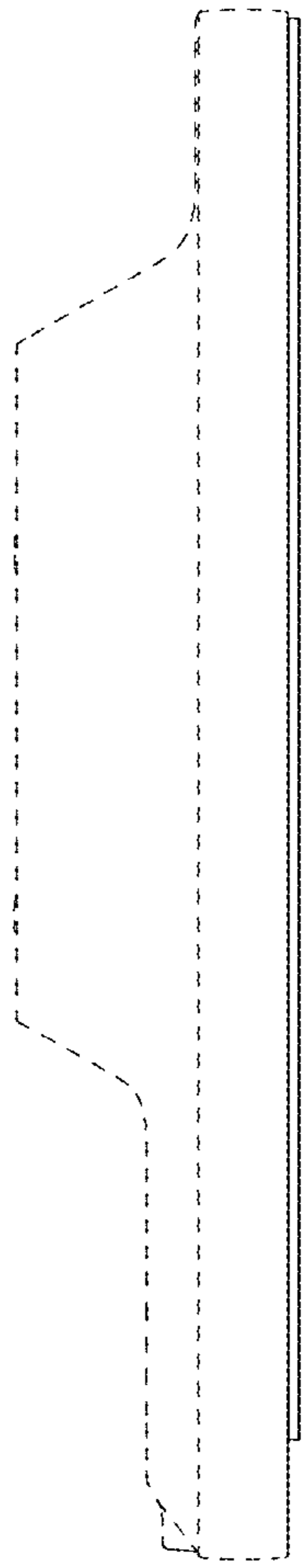

FIG.19

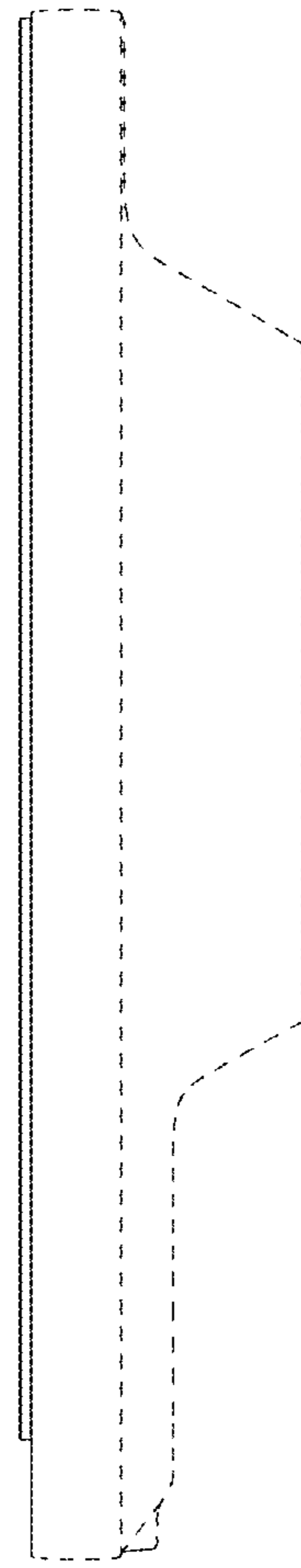

FIG.20

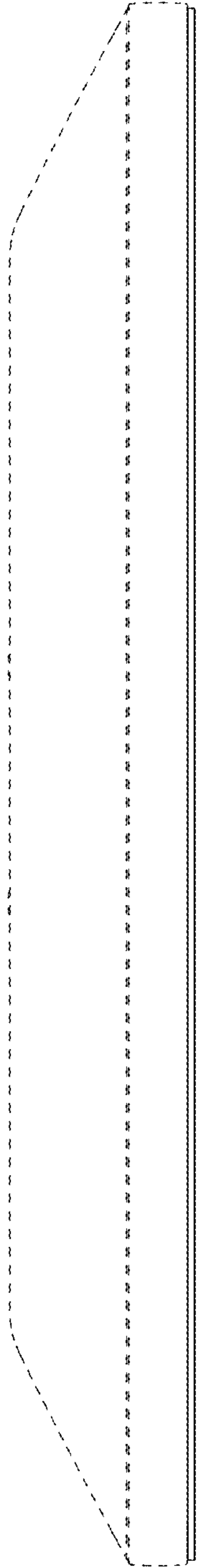

FIG.21

