



US00D821272S

(12) **United States Design Patent**
Han

(10) **Patent No.:** **US D821,272 S**
(45) **Date of Patent:** **** Jun. 26, 2018**

- (54) **RADIATOR GRILLE OF CAR**
- (71) Applicant: **GM GLOBAL TECHNOLOGY OPERATIONS LLC**, Detroit, MI (US)
- (72) Inventor: **Hongchul Han**, Incheon (KR)
- (73) Assignee: **GM GLOBAL TECHNOLOGY OPERATIONS LLC**, Detroit, MI (US)
- (**) Term: **15 Years**
- (21) Appl. No.: **29/578,077**
- (22) Filed: **Sep. 19, 2016**
- (30) **Foreign Application Priority Data**

Mar. 18, 2016 (KR) 30-2016-0012838

- (51) **LOC (11) Cl.** **12-16**
- (52) **U.S. Cl.**
USPC **D12/163**
- (58) **Field of Classification Search**
USPC D12/86, 91, 93, 163, 164, 166, 167, 169,
D12/171, 172, 173, 190, 216
CPC B62B 9/16; B60K 11/08; B60R 19/52
See application file for complete search history.

(56) **References Cited**

U.S. PATENT DOCUMENTS

- 6,328,358 B1 * 12/2001 Berweiler B60R 19/52
180/68.6
- D584,196 S * 1/2009 Ebel D12/163
- D589,853 S * 4/2009 Saridakis D12/163
- D642,964 S * 8/2011 Miyazawa D12/163
- D647,011 S * 10/2011 Verhee D12/169
- D668,590 S * 10/2012 Furst D12/163
- D679,225 S * 4/2013 Gifford D12/163
- D680,918 S * 4/2013 Yamada D12/163
- D701,151 S * 3/2014 Cartabiano D12/169

- D703,108 S * 4/2014 Futschik D12/163
- D705,699 S * 5/2014 Ware D12/91
- D711,794 S * 8/2014 Okamura D12/169
- D716,197 S * 10/2014 Terui D12/163
- D721,019 S * 1/2015 Pevovar D12/163
- D732,430 S * 6/2015 Loeb D12/91
- D748,543 S * 2/2016 Nissl D12/169
- D755,088 S * 5/2016 McMahan D12/163
- D763,152 S * 8/2016 Frascella D12/190
- 9,469,187 B1 * 10/2016 Ho B60K 11/08
- D775,003 S * 12/2016 Pevovar D12/163
- D775,554 S * 1/2017 Kapitonov D12/163
- D776,020 S * 1/2017 Kapitonov D12/163
- D780,631 S * 3/2017 Kozub D12/91
- D780,644 S * 3/2017 Kim D12/163
- D782,943 S * 4/2017 Kavaja D12/163
- D782,944 S * 4/2017 Pevovar D12/163
- D786,145 S * 5/2017 Kozub D12/163
- D787,993 S * 5/2017 McCabe D12/173
- 2004/0190985 A1 * 9/2004 Aigner B60R 19/52
403/329

(Continued)

Primary Examiner — Susan Bennett Hattan
Assistant Examiner — Suzanne E Tisdell
(74) *Attorney, Agent, or Firm* — Browdy and Neimark, PLLC

(57) **CLAIM**

The ornamental design for a radiator grille of car, as shown.

DESCRIPTION

FIG. 1 is a perspective view of a radiator grille of car, showing my new design;
FIG. 2 is a front elevation view thereof;
FIG. 3 is a rear elevation view thereof;
FIG. 4 is a first side elevation view thereof;
FIG. 5 is a second side elevation view thereof, opposite of the first side elevation view;
FIG. 6 is a top plan view thereof; and,
FIG. 7 is a bottom plan view thereof.

1 Claim, 7 Drawing Sheets

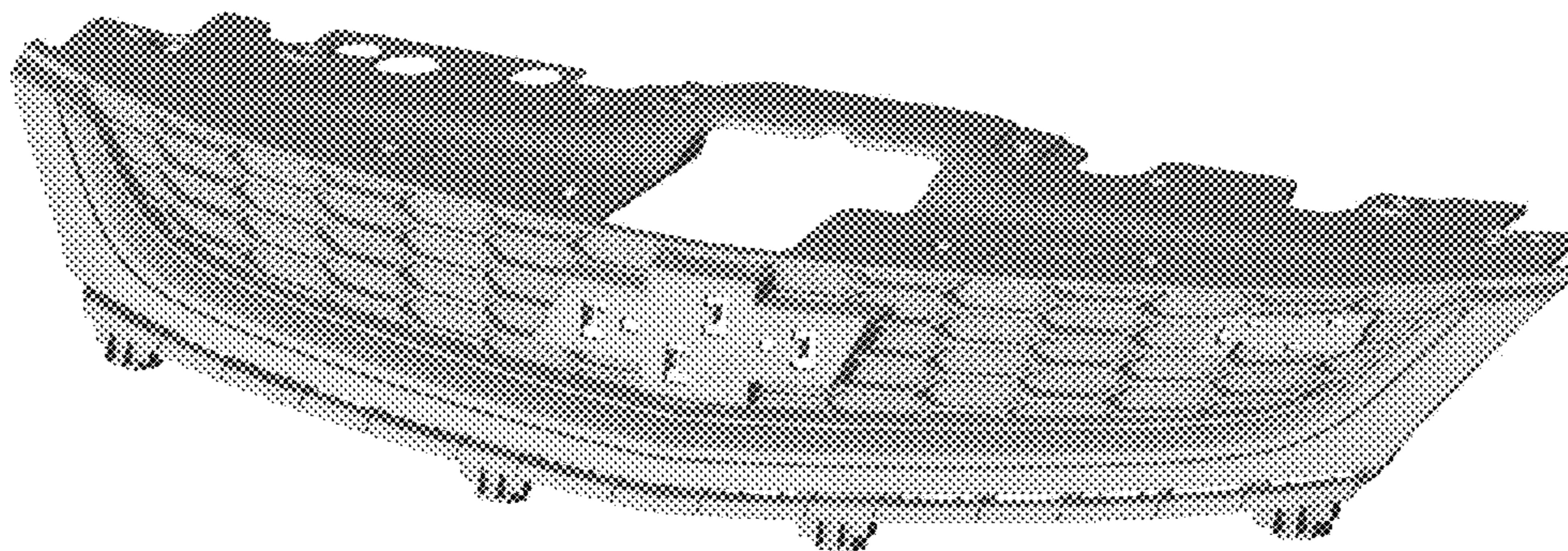

(56)

References Cited

U.S. PATENT DOCUMENTS

2005/0006913 A1* 1/2005 Otte B60R 19/52
293/115
2006/0157992 A1* 7/2006 Sakamoto B60R 19/52
293/115
2008/0079271 A1* 4/2008 Maruko B60R 19/52
293/102
2010/0148525 A1* 6/2010 Abdelnour B60R 19/52
293/115
2011/0181062 A1* 7/2011 Bernt B60K 11/085
293/102
2014/0291056 A1* 10/2014 Takanaga B60K 11/085
180/274
2016/0325790 A1* 11/2016 Murray B62D 25/02

* cited by examiner

FIG. 1

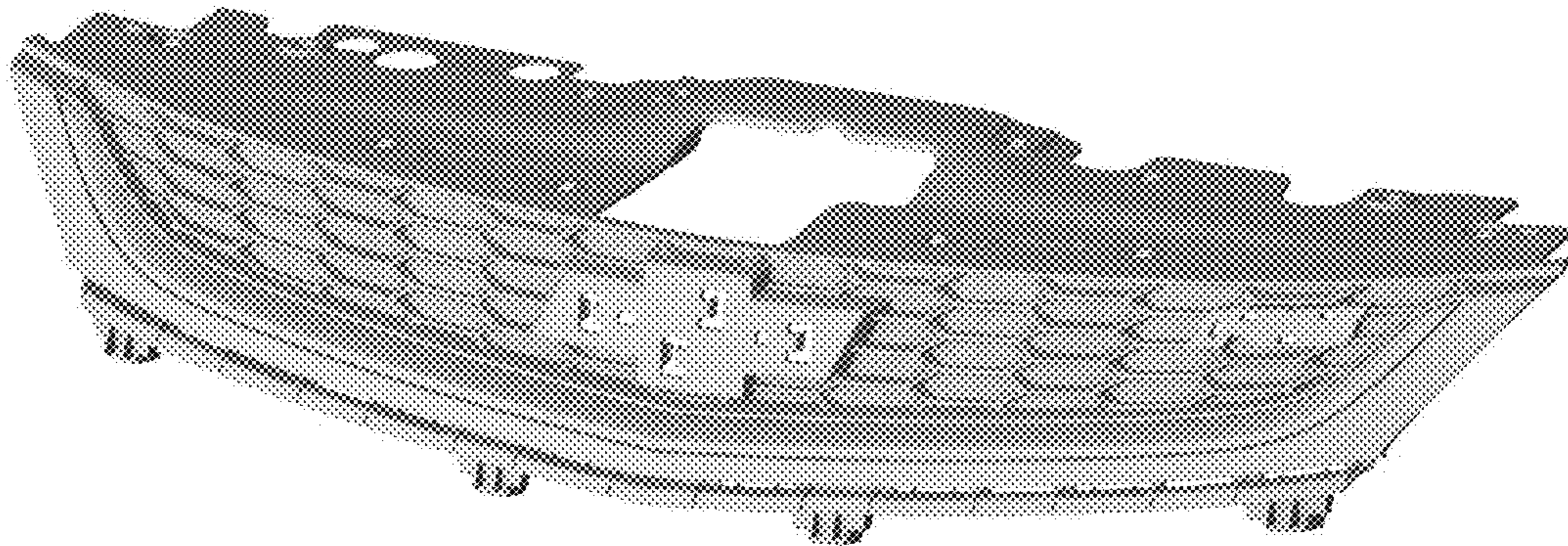

FIG. 2

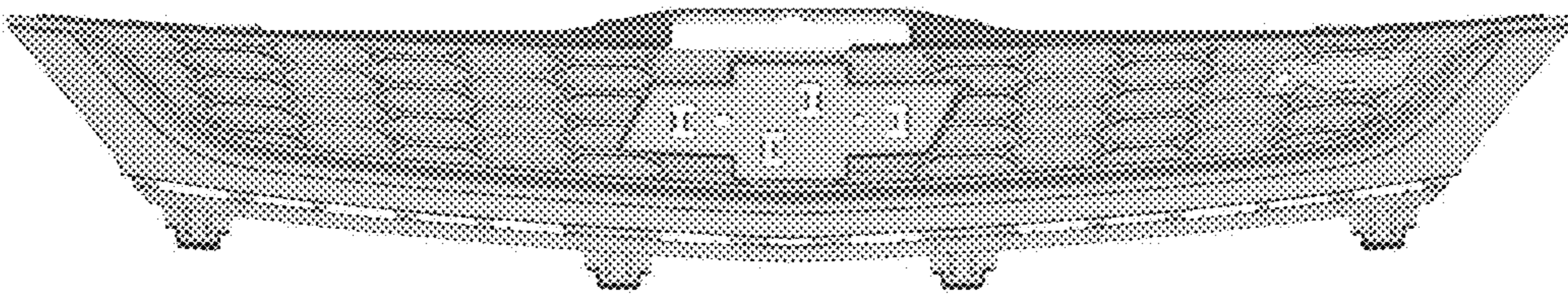

FIG. 3

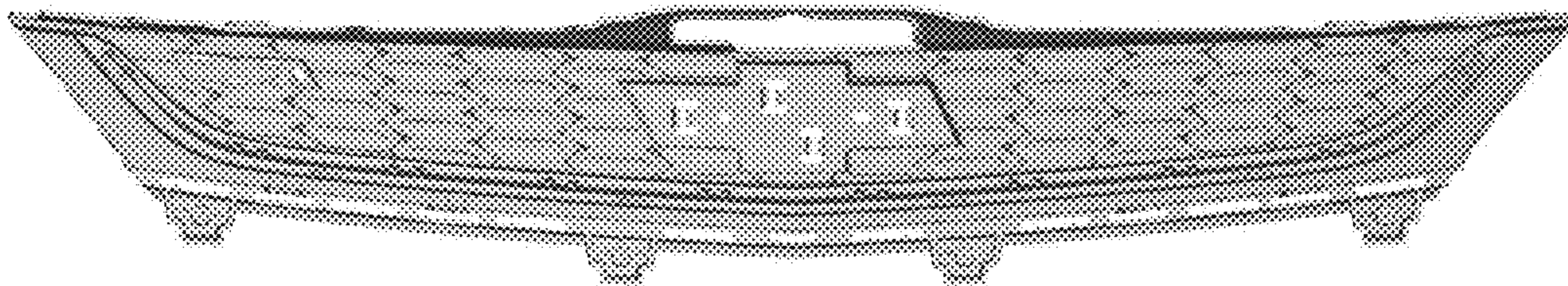

FIG. 4

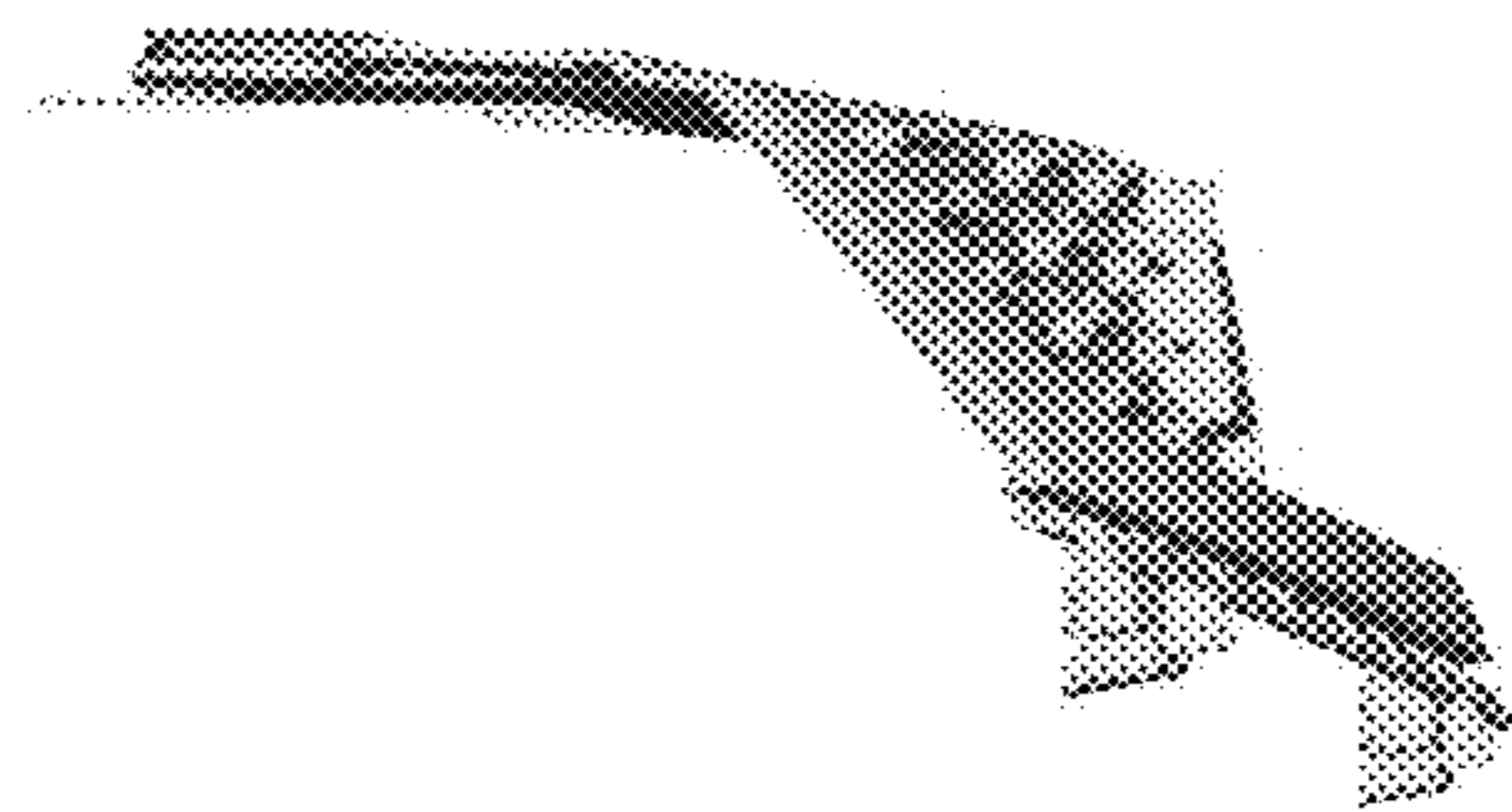

FIG. 5

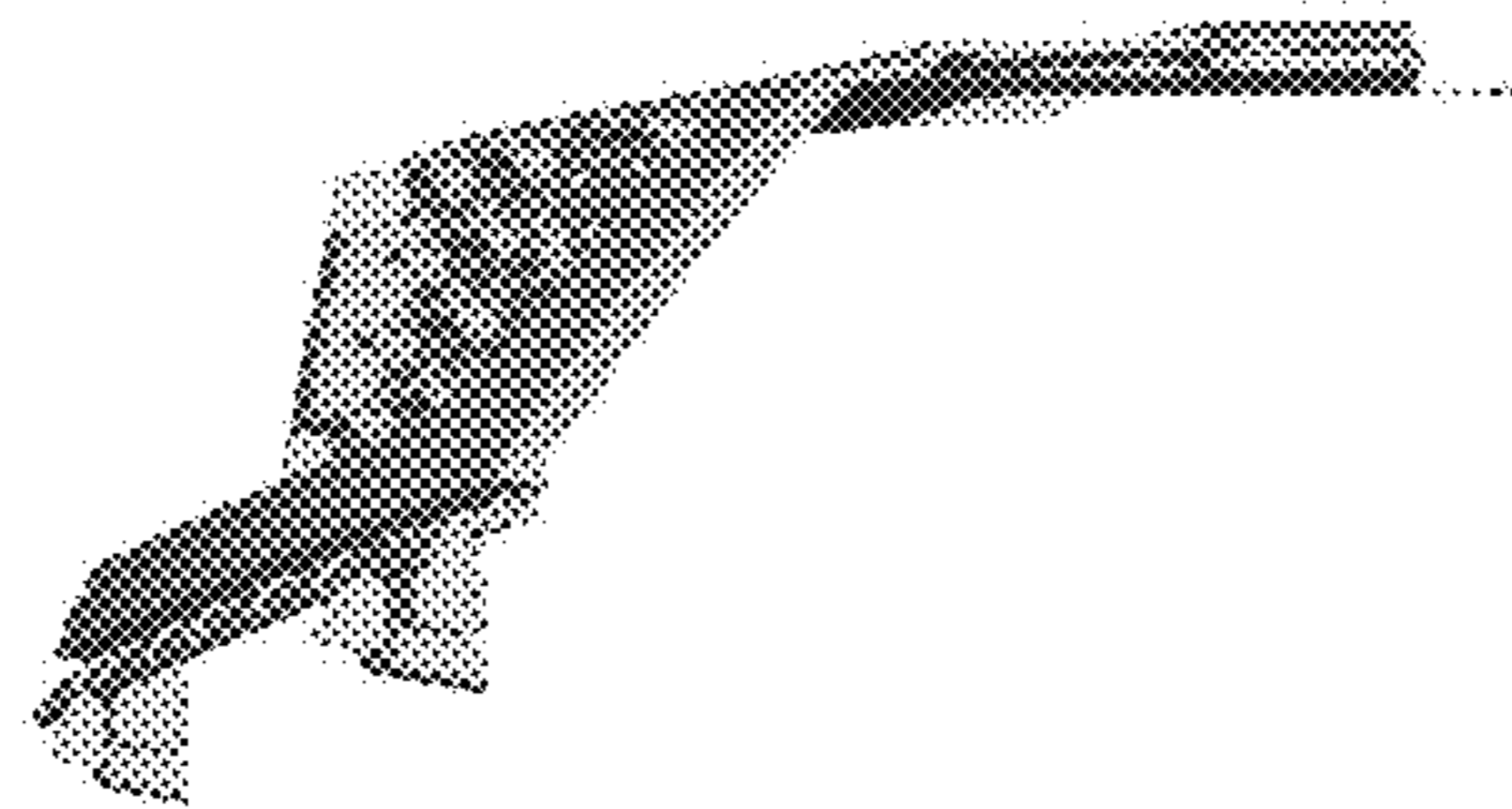

FIG. 6

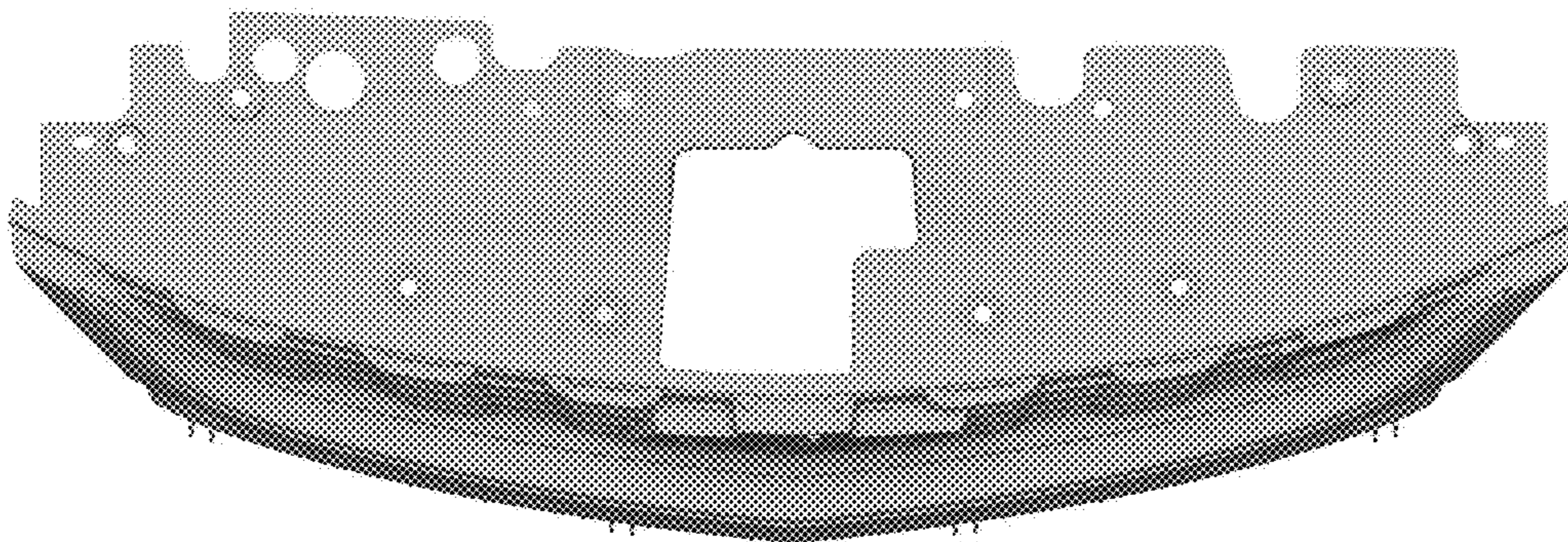

FIG. 7

