



US00D821238S

(12) **United States Design Patent**
Elmieh et al.

(10) **Patent No.:** **US D821,238 S**
(45) **Date of Patent:** **** Jun. 26, 2018**

(54) **WATER MONITORING SYSTEM**
(71) Applicant: **Facebook, Inc.**, Menlo Park, CA (US)
(72) Inventors: **Baback Elmieh**, Palo Alto, CA (US);
Alexandre Jais, Menlo Park, CA (US);
Rex Wenters Crossen, Piedmont, CA (US);
Achille Biteau, San Francisco, CA (US);
Victoria Slaker, San Francisco, CA (US);
Andrew Alexander Robberts, Redwood City, CA (US)
(73) Assignee: **Facebook, Inc.**, Menlo Park, CA (US)

D418,073 S * 12/1999 Kreutzer D10/81
D437,797 S * 2/2001 Bishop D10/103
D500,455 S * 1/2005 Munoz et al. D10/101
D750,990 S * 3/2016 Ettlin D10/81
D769,140 S * 10/2016 Park D10/81
9,863,611 B2 * 1/2018 Gutekunst F21S 8/00

FOREIGN PATENT DOCUMENTS

CN 303561804 S 1/2016
CN 303853119 S 9/2016
JP 05-99497 4/1993
JP 1551816 S 6/2016
JP 1566522 S 1/2017
TW D119361 10/2007

* cited by examiner

Primary Examiner — Antoine Duval Davis
(74) *Attorney, Agent, or Firm* — Fenwick & West LLP

(**) Term: **15 Years**
(21) Appl. No.: **29/589,304**
(22) Filed: **Dec. 29, 2016**
(51) **LOC (11) Cl.** **10-04**
(52) **U.S. Cl.**
USPC **D10/101**
(58) **Field of Classification Search**
USPC D10/81, 101
CPC G08B 21/02; G08B 21/18; G08B 21/182;
G08B 21/20; G08B 3/00; G08B 19/00;
G08B 19/02; G01D 7/00; G01D 11/24;
G01D 11/245; G01F 1/00; G01N
33/0031; G01N 33/0032; G01M 3/16;
G01M 3/38
See application file for complete search history.

(57) **CLAIM**

The ornamental design for a water monitoring system, as shown and described.

DESCRIPTION

FIG. 1 is a perspective view of a water monitoring system, showing our new design;
FIG. 2 is a front view thereof;
FIG. 3 is a rear view thereof;
FIG. 4 is a left side view thereof;
FIG. 5 is a right side view thereof;
FIG. 6 is a top view thereof; and,
FIG. 7 is a bottom view thereof.
The broken lines in the figures form no part of the claimed design.

(56) **References Cited**
U.S. PATENT DOCUMENTS
5,403,451 A * 4/1995 Riviello G01N 27/3277
204/409
5,517,174 A * 5/1996 Barrows G01F 23/60
340/431

1 Claim, 7 Drawing Sheets

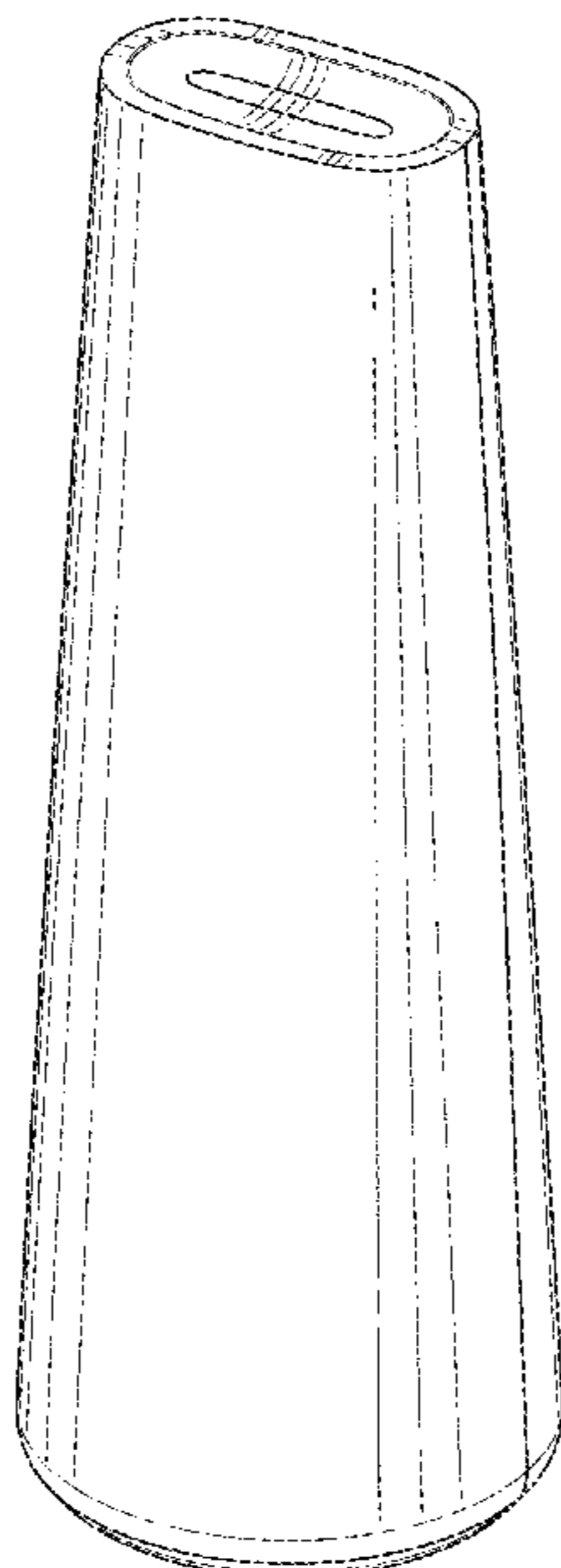

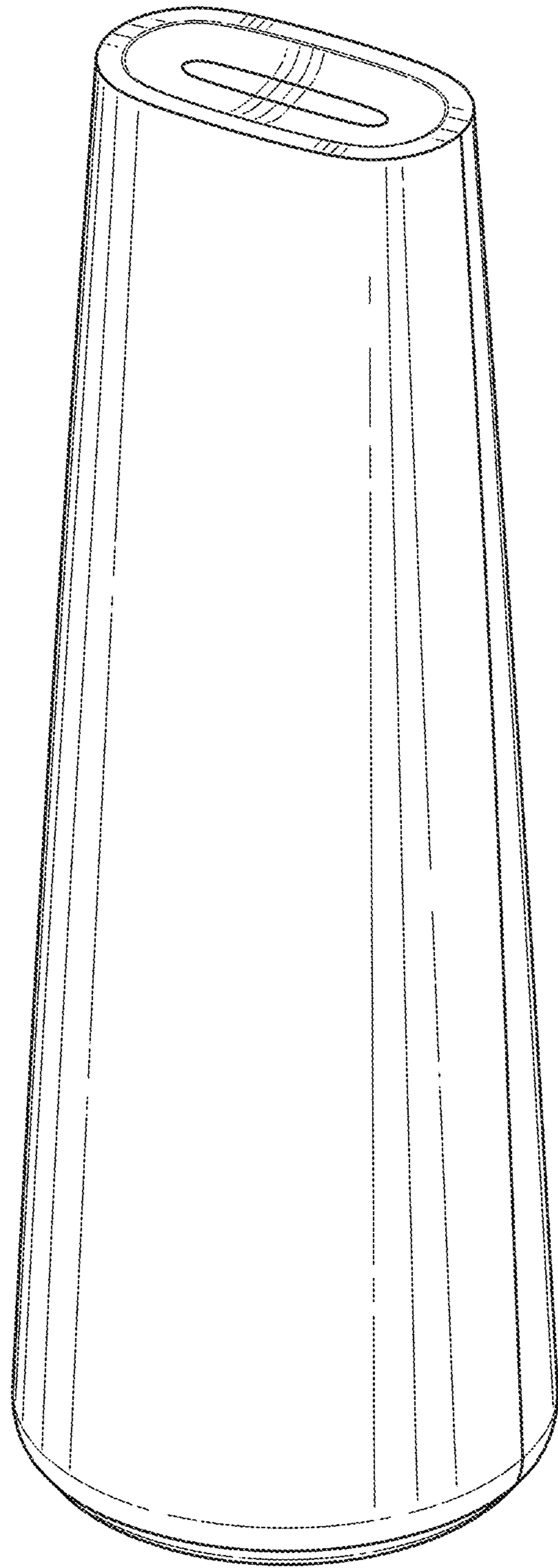

FIG. 1

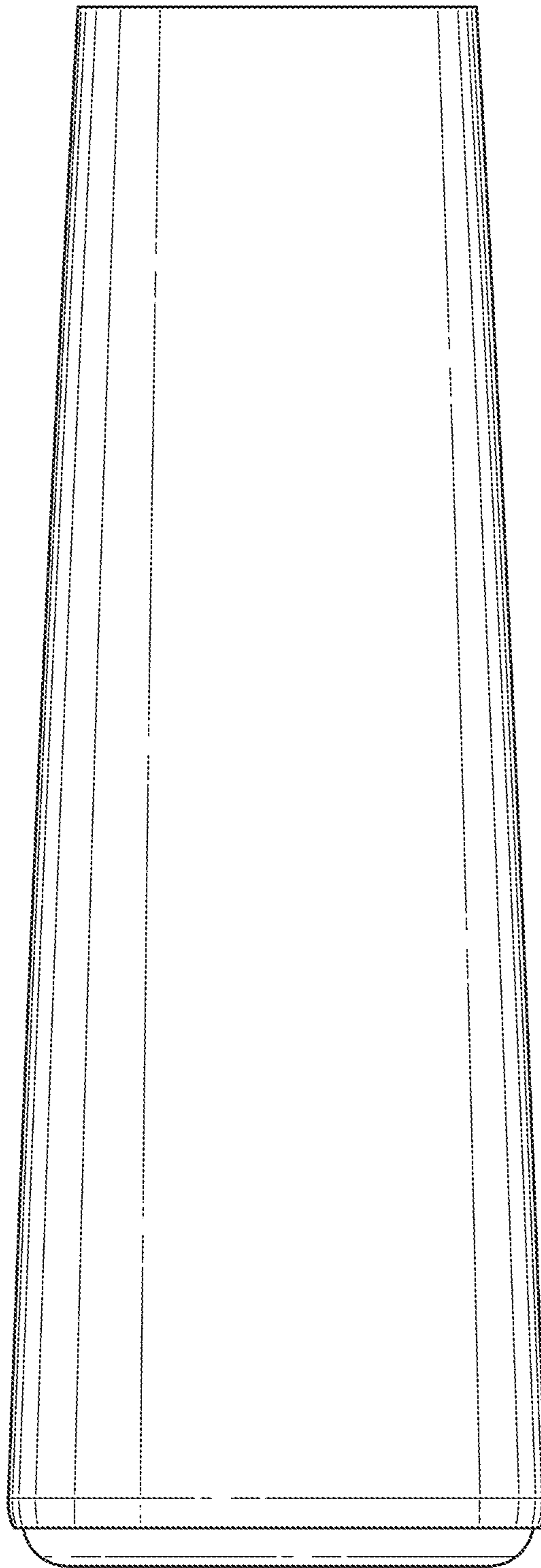

FIG. 2

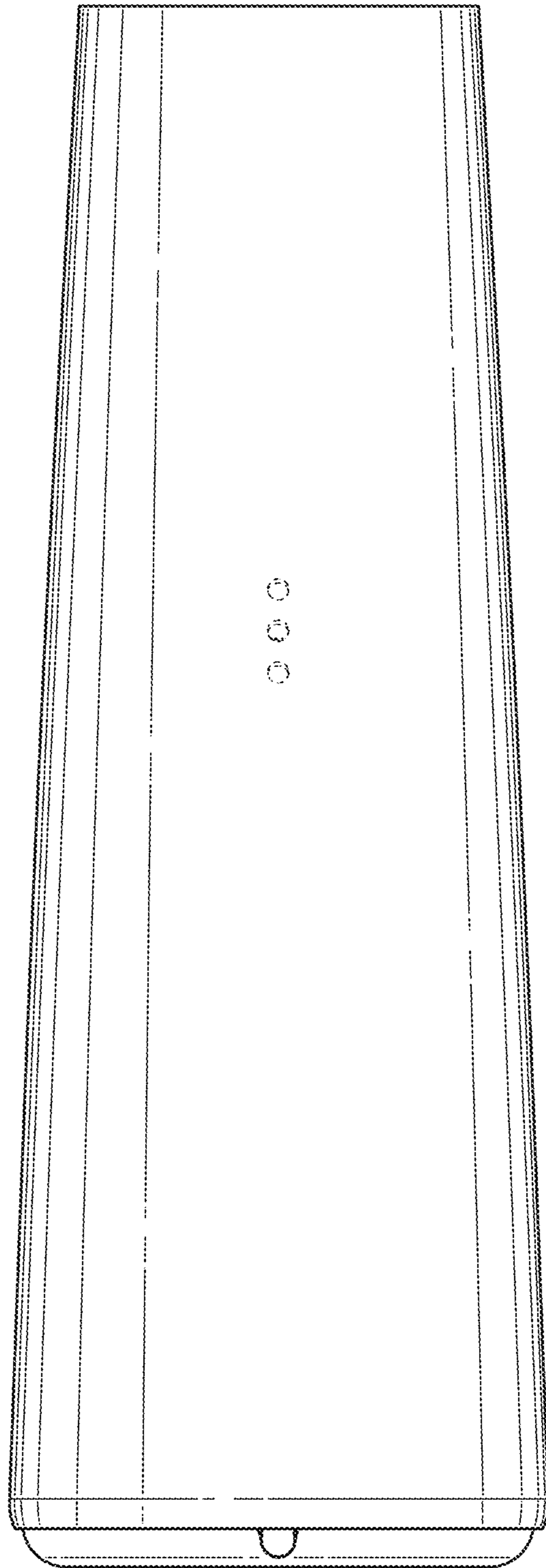

FIG. 3

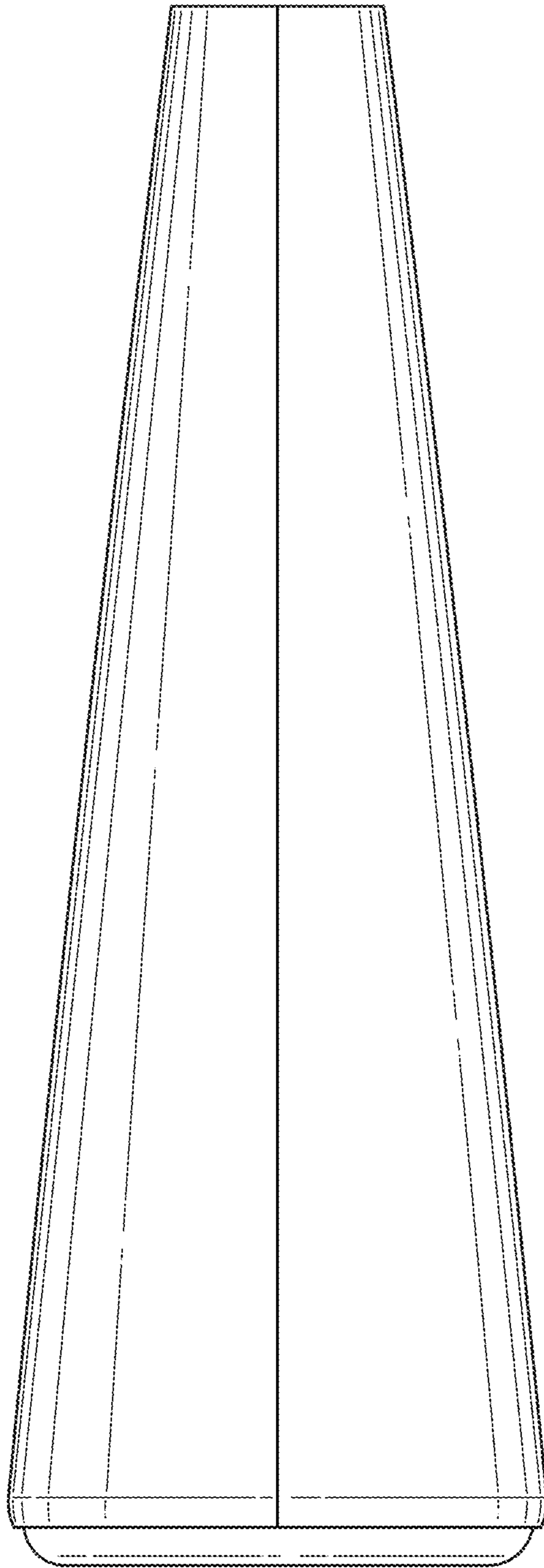

FIG. 4

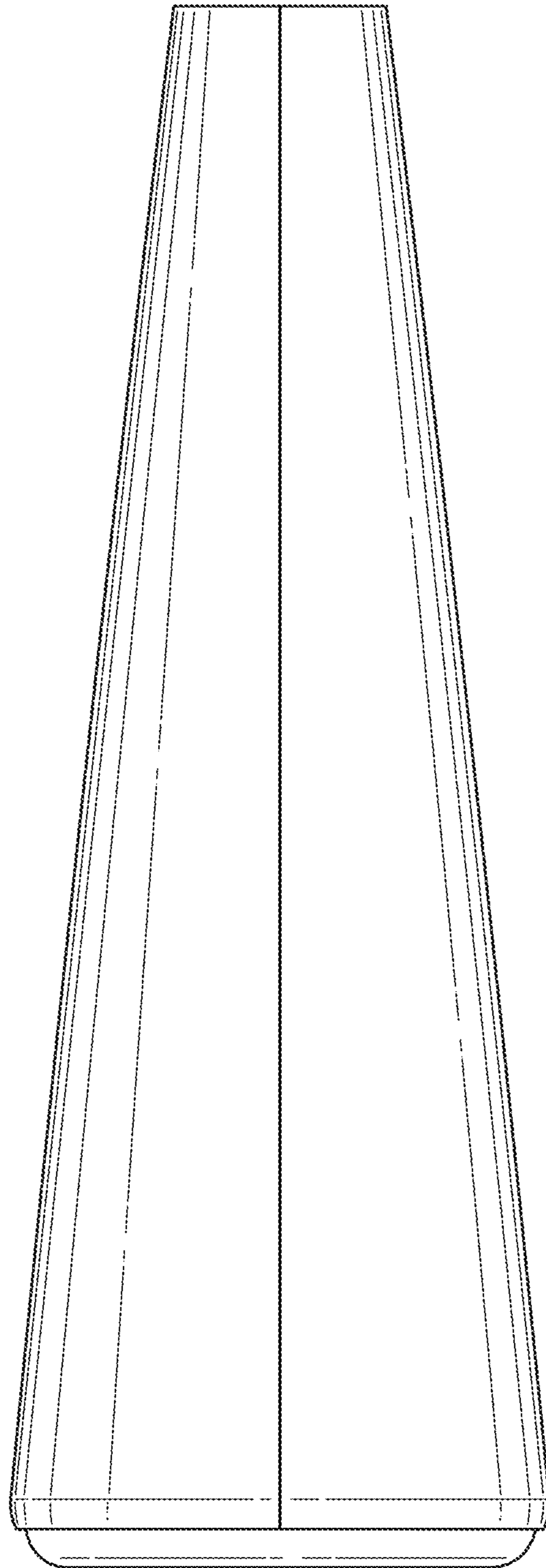

FIG. 5

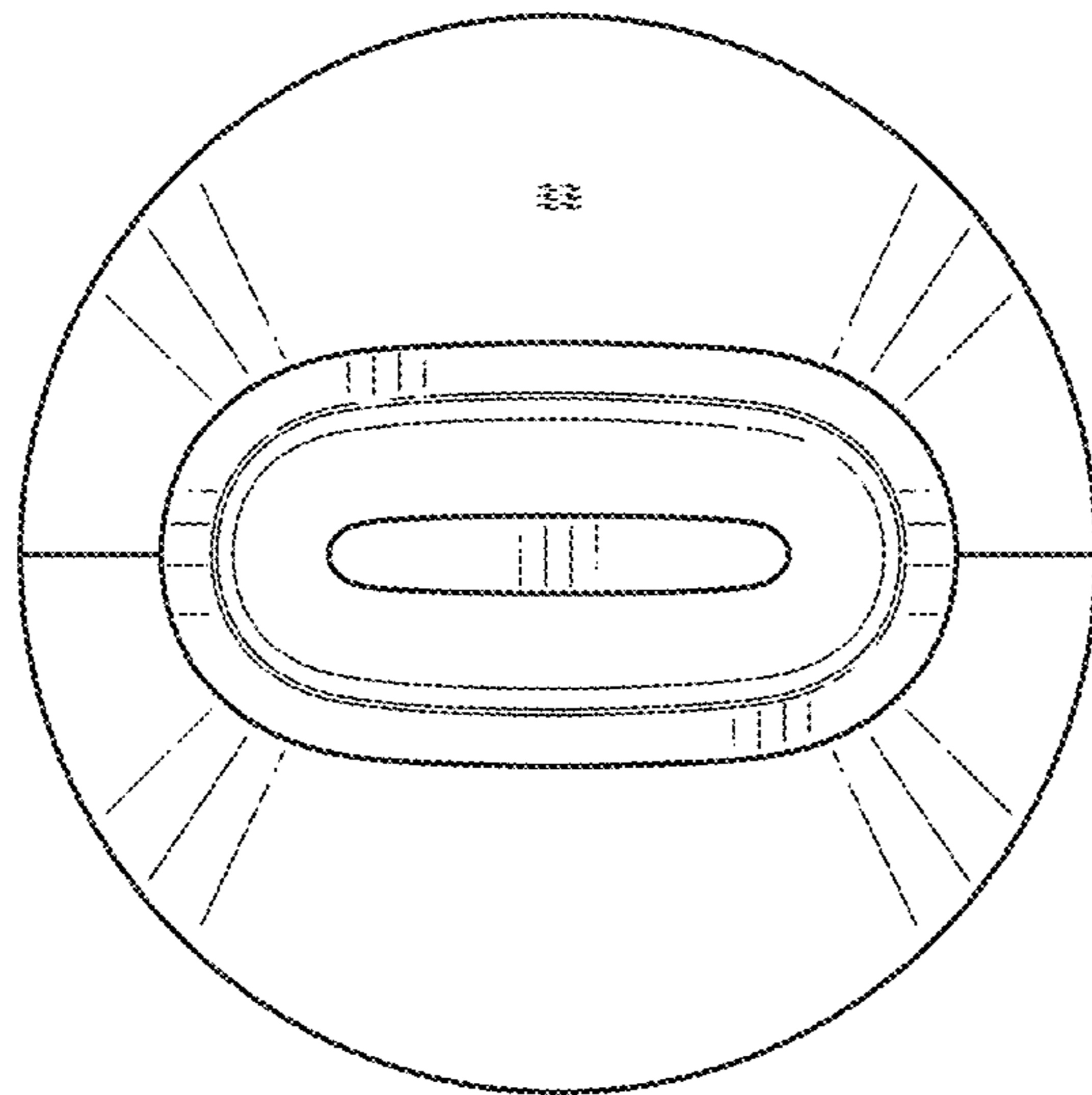

FIG. 6

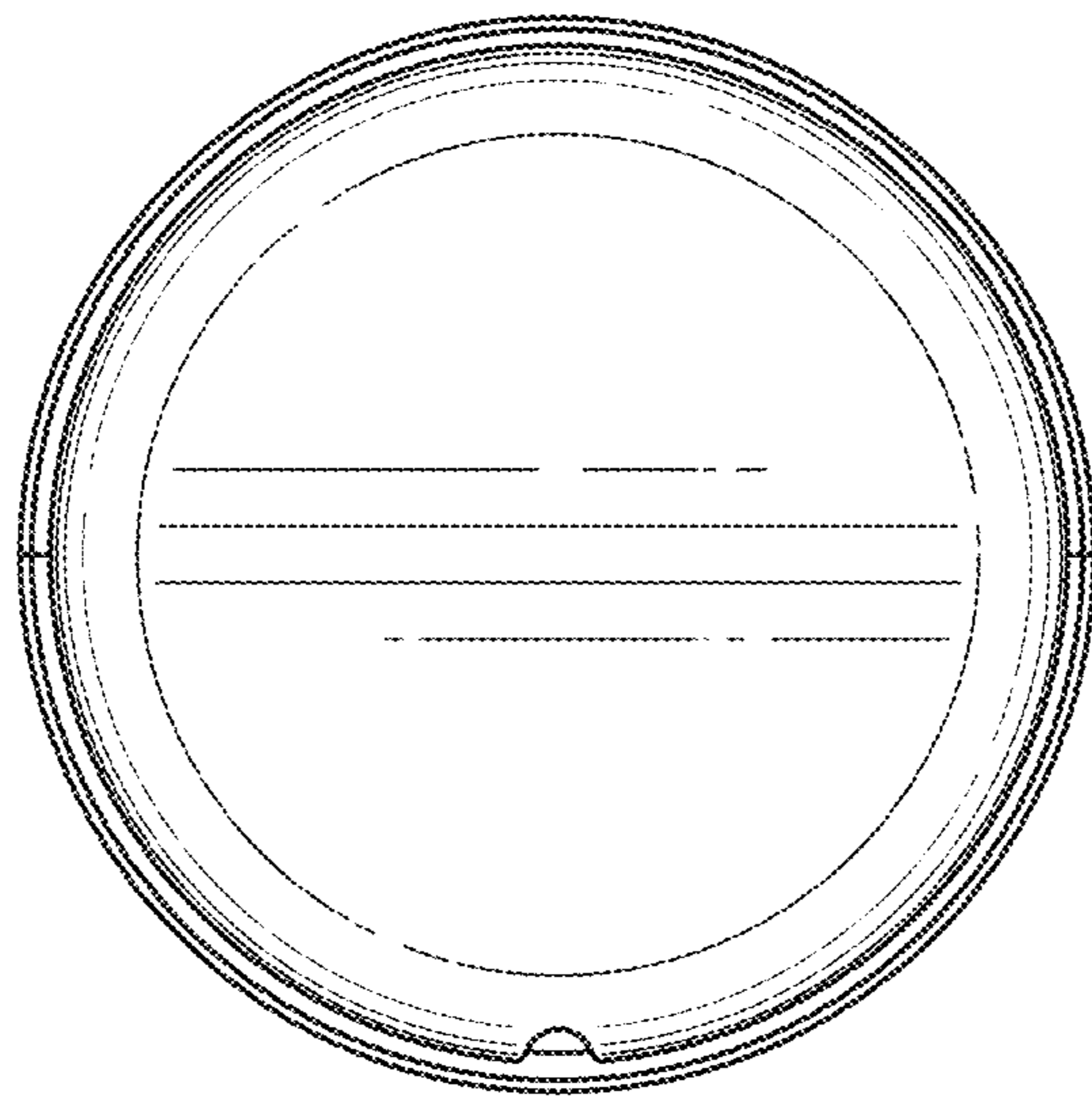

FIG. 7