



US00D821214S

(12) **United States Design Patent**  
**Mazur et al.**

(10) **Patent No.:** **US D821,214 S**  
(45) **Date of Patent:** **\*\* Jun. 26, 2018**

- (54) **BOTTLE**
- (71) Applicant: **Henkel AG & Co. KGaA**, Duesseldorf (DE)
- (72) Inventors: **Matthias Mazur**, Hamburg (DE);  
**Simon Kindler**, Hamburg (DE)
- (73) Assignee: **Henkel AG & Co. KGaA**, Henkel
- (\*\*) Term: **15 Years**
- (21) Appl. No.: **29/567,790**
- (22) Filed: **Jun. 13, 2016**

**Related U.S. Application Data**

- (62) Division of application No. 29/490,386, filed on May 9, 2014, now Pat. No. Des. 759,491.

(30) **Foreign Application Priority Data**

Nov. 13, 2013 (EM) ..... 002344614

- (51) **LOC (11) Cl.** ..... **09-01**
- (52) **U.S. Cl.**

USPC ..... **D9/543**; D9/551; D9/571; D9/575

(58) **Field of Classification Search**

USPC ..... D9/682-694, 516, 522, 529, 530,  
D9/537-543, 549-558, 563-575,  
D9/723-729, 738-739, 763, 766, 781,  
D9/434-436

CPC ..... B65D 1/00; B65D 1/0223; B65D 1/40;  
B65D 1/42; B65D 23/00; B65D 23/102;  
B65D 2501/00; B65D 2501/0009; B65D  
2501/0081

See application file for complete search history.

(56) **References Cited**

**U.S. PATENT DOCUMENTS**

- D32,104 S \* 1/1900 Dula ..... D9/650
- D203,229 S \* 12/1965 Szajna ..... D9/542

- D204,501 S \* 4/1966 Ferer ..... D9/542
- D220,561 S \* 4/1971 Quintal ..... D9/563
- D237,358 S \* 10/1975 Blank ..... D9/542
- D238,854 S \* 2/1976 Britt ..... D9/542
- D280,603 S \* 9/1985 Johnson ..... D9/453
- D346,964 S \* 5/1994 Green ..... D9/574
- D349,059 S \* 7/1994 Zogg ..... D9/542
- D353,775 S \* 12/1994 Thompson ..... D9/545
- D375,255 S \* 11/1996 Uhl ..... D24/115
- D408,742 S \* 4/1999 Goettner ..... D9/531
- D451,402 S \* 12/2001 Kokenge ..... D9/549
- D469,022 S \* 1/2003 Kuzma ..... D9/550
- D491,456 S \* 6/2004 Cagle ..... D9/687
- D557,610 S \* 12/2007 Conway ..... D9/530
- D579,778 S \* 11/2008 De Gopegui ..... D9/523
- D590,263 S \* 4/2009 Matsumura ..... D9/529
- D601,907 S \* 10/2009 Gainey ..... D9/539
- D670,174 S \* 11/2012 Hague ..... D9/563
- D703,059 S \* 4/2014 Chopdat ..... D9/529

(Continued)

*Primary Examiner* — Catherine A Tuttle

(74) *Attorney, Agent, or Firm* — Thomas G. Krivulka

(57) **CLAIM**

The ornamental design for a bottle, as shown and described.

**DESCRIPTION**

FIG. 1 is a front perspective view of a bottle according to our new design;

FIG. 2 is a front elevation view thereof;

FIG. 3 is a rear elevation view thereof;

FIG. 4 is a right side elevation view thereof;

FIG. 5 is a left side elevation view thereof;

FIG. 6 is a top plan view thereof; and,

FIG. 7 is a bottom plan view thereof.

The broken lines are included for the purpose of illustrating the portions of the bottle that form no part of the claimed design.

**1 Claim, 7 Drawing Sheets**

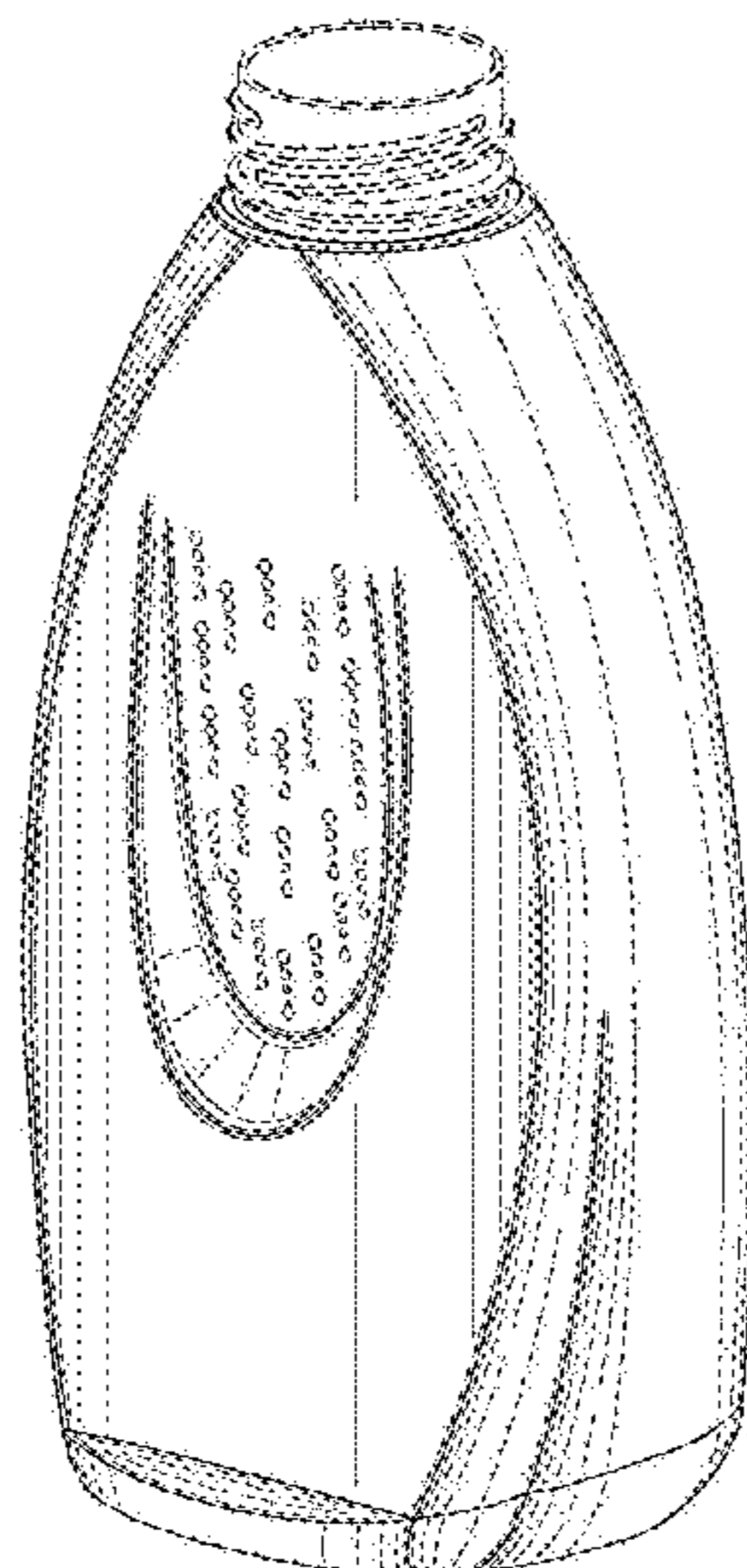

(56)

**References Cited**

U.S. PATENT DOCUMENTS

D714,152 S \* 9/2014 Rhodes ..... D9/529  
D759,491 S \* 6/2016 Mazur ..... D9/542  
2014/0331416 A1\* 11/2014 Akinbobola ..... A61K 8/22  
8/405

\* cited by examiner

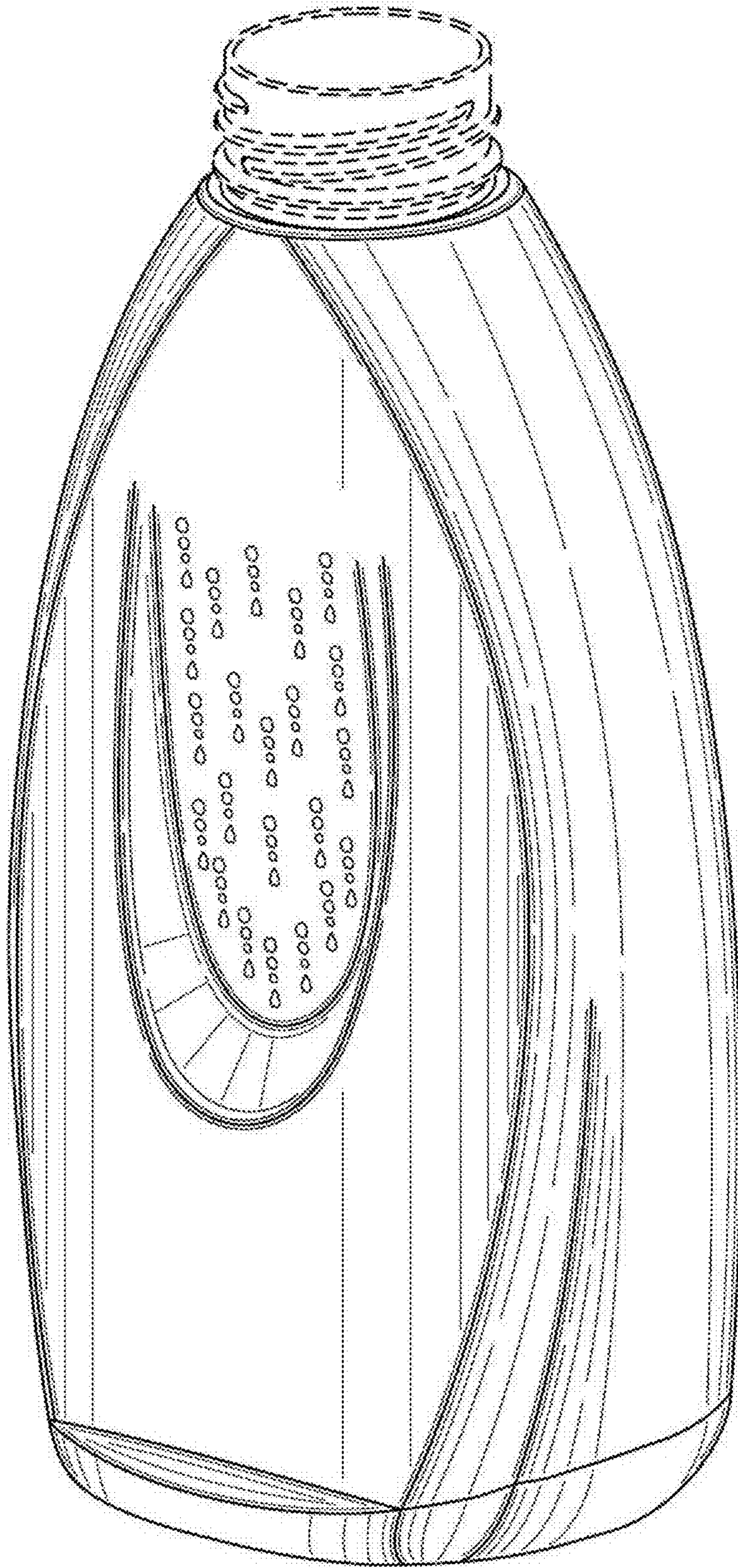

FIG. 1



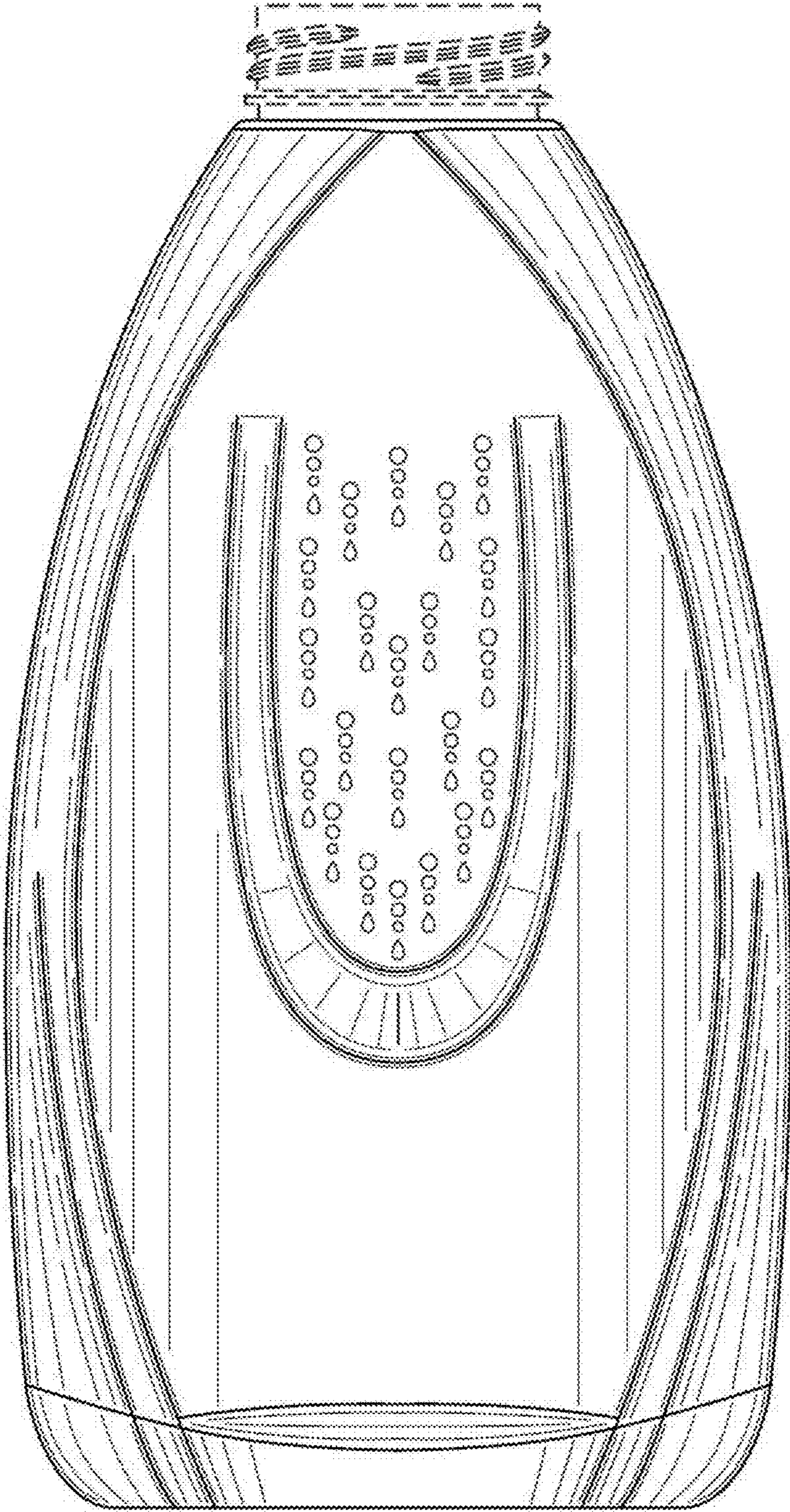

FIG. 2



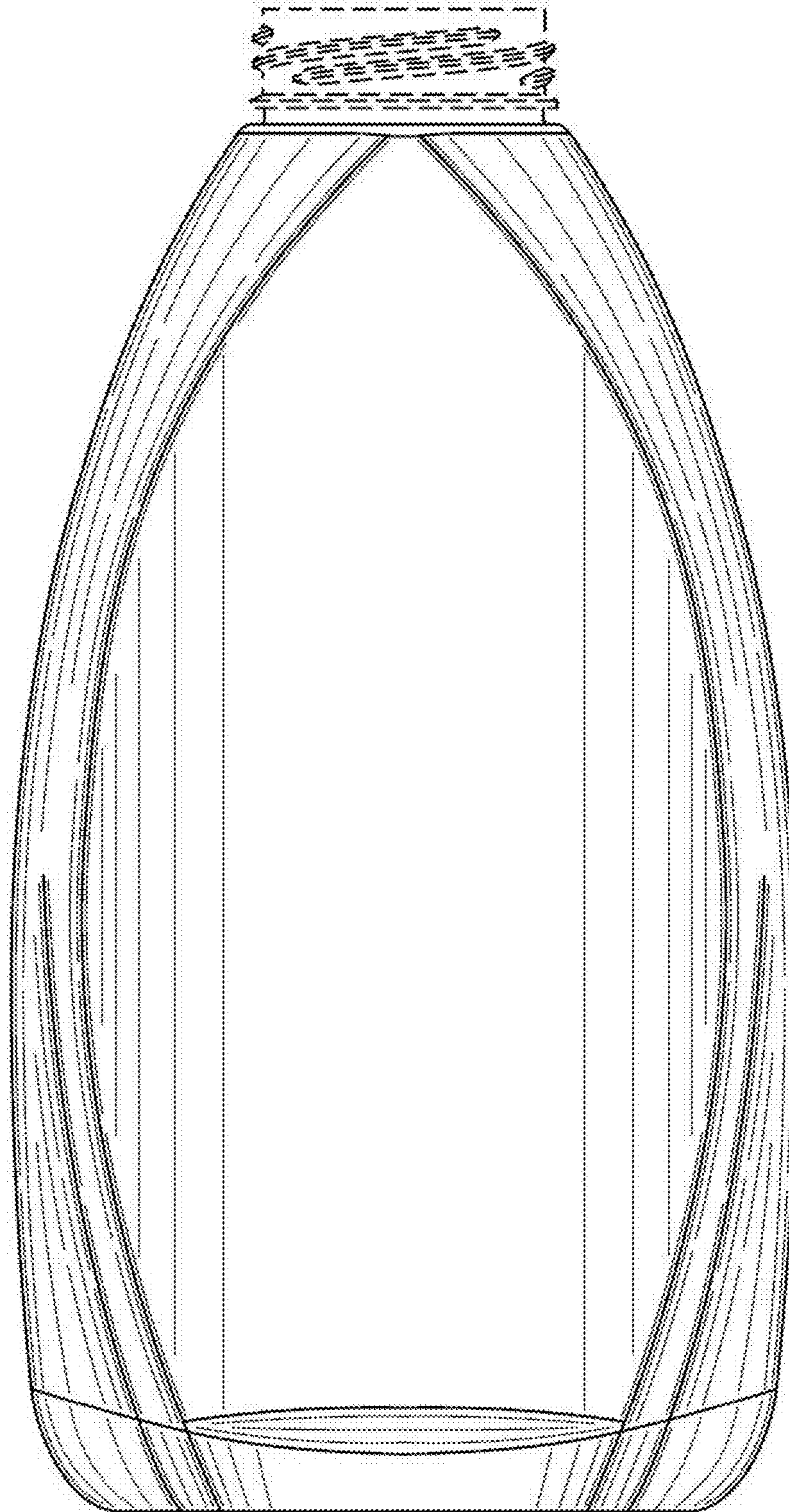

FIG. 3

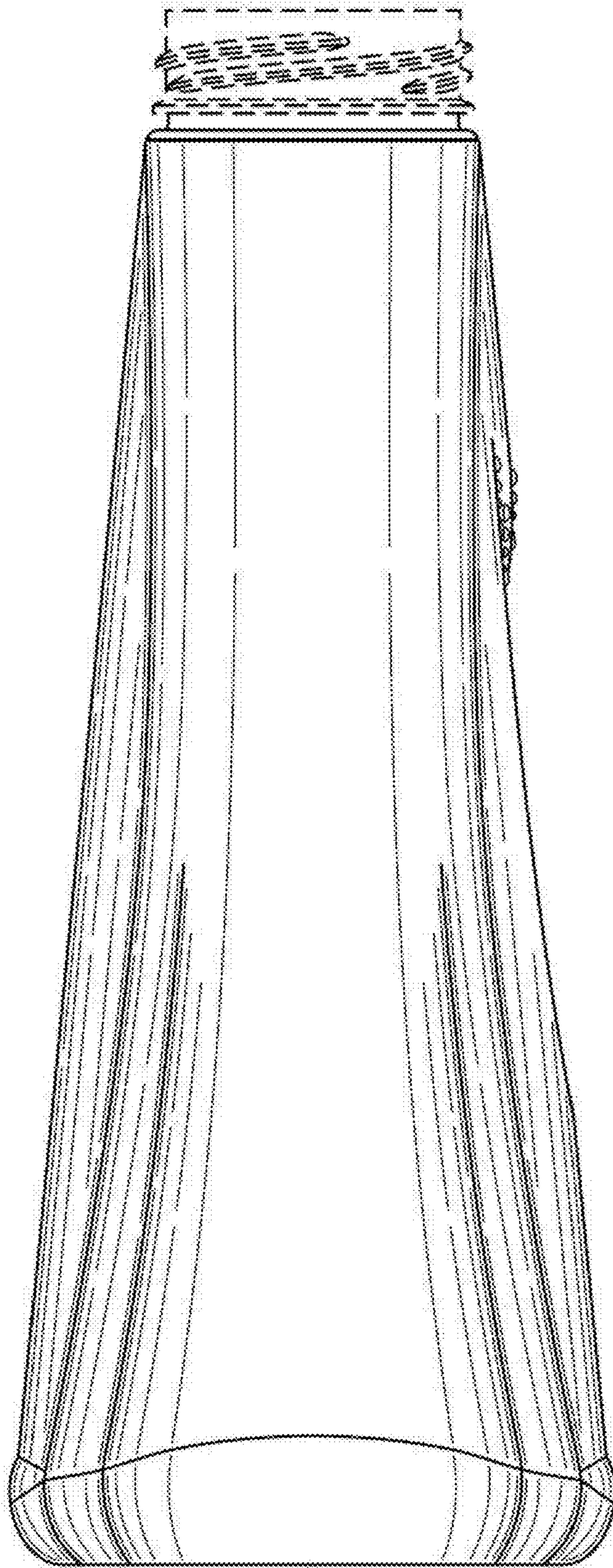

FIG. 4



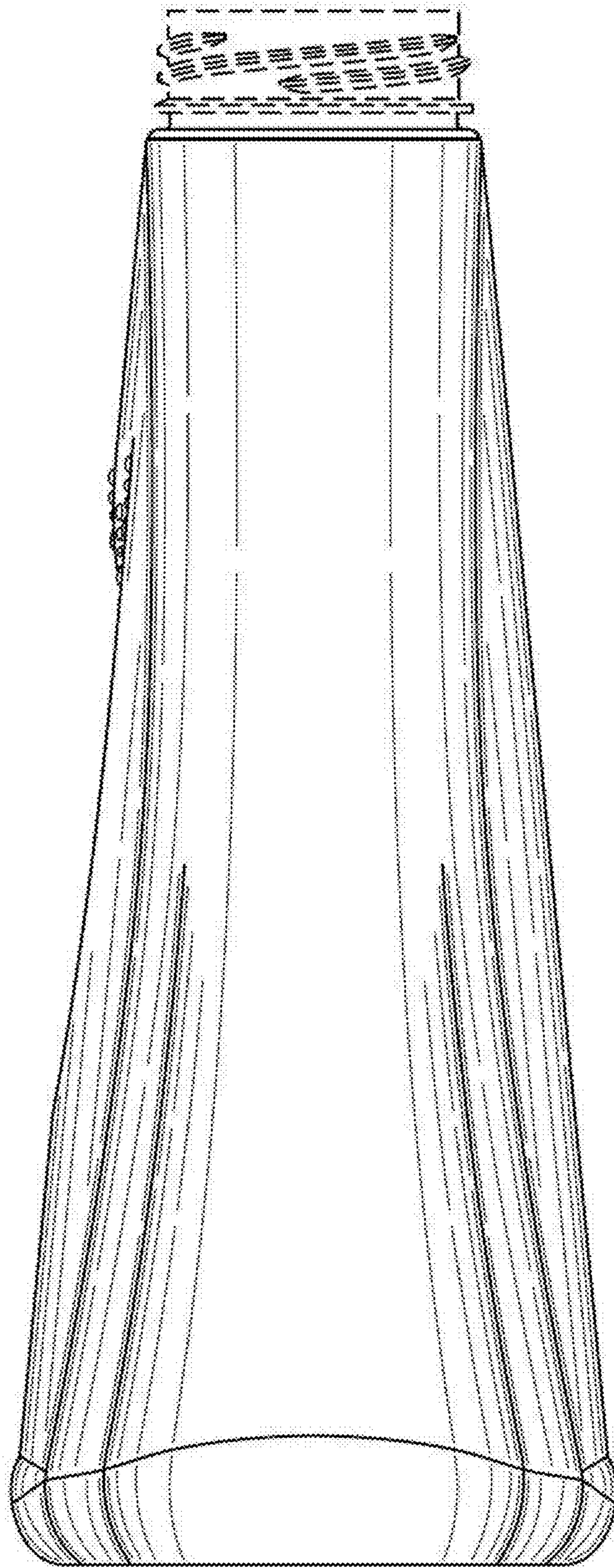

FIG. 5

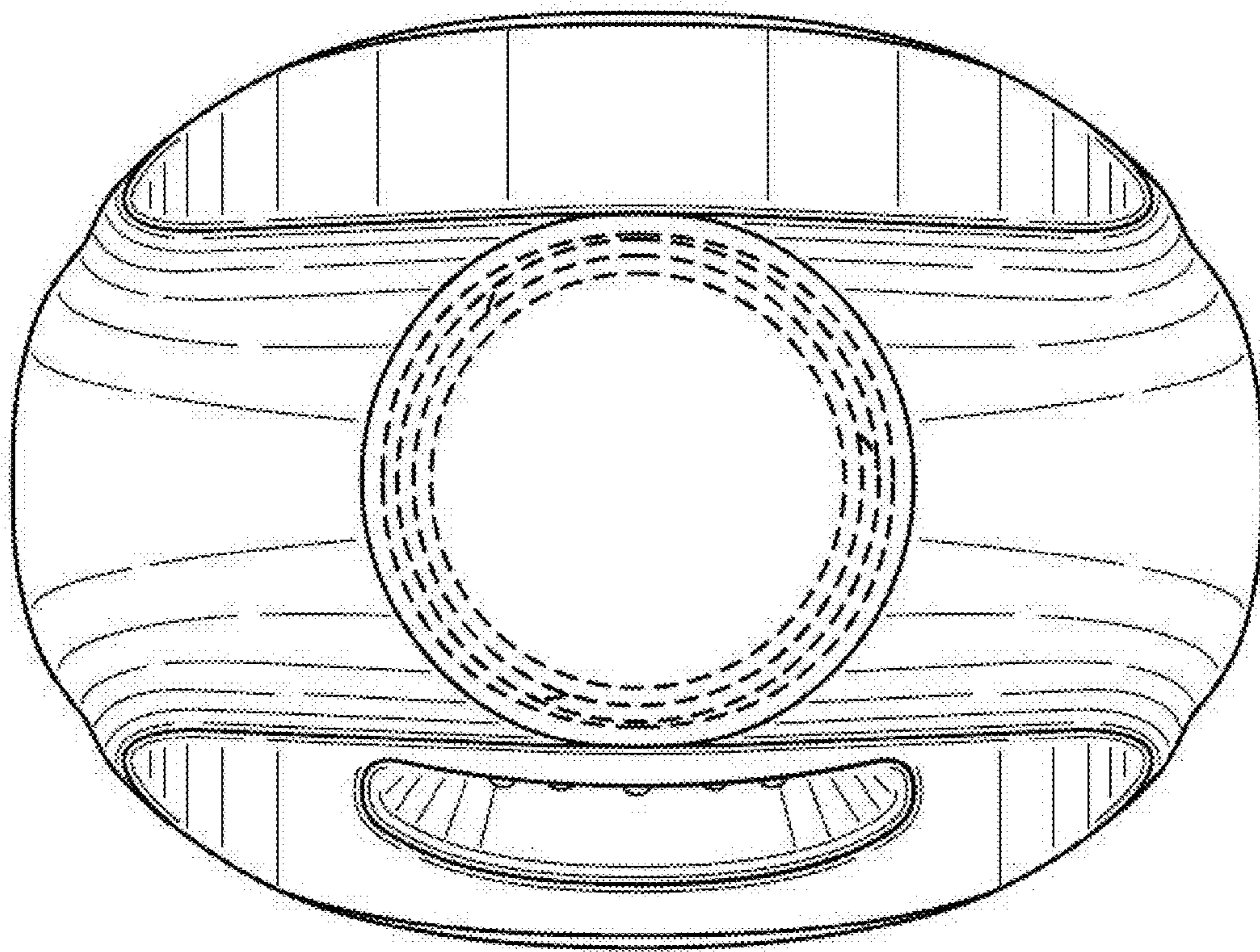

FIG. 6



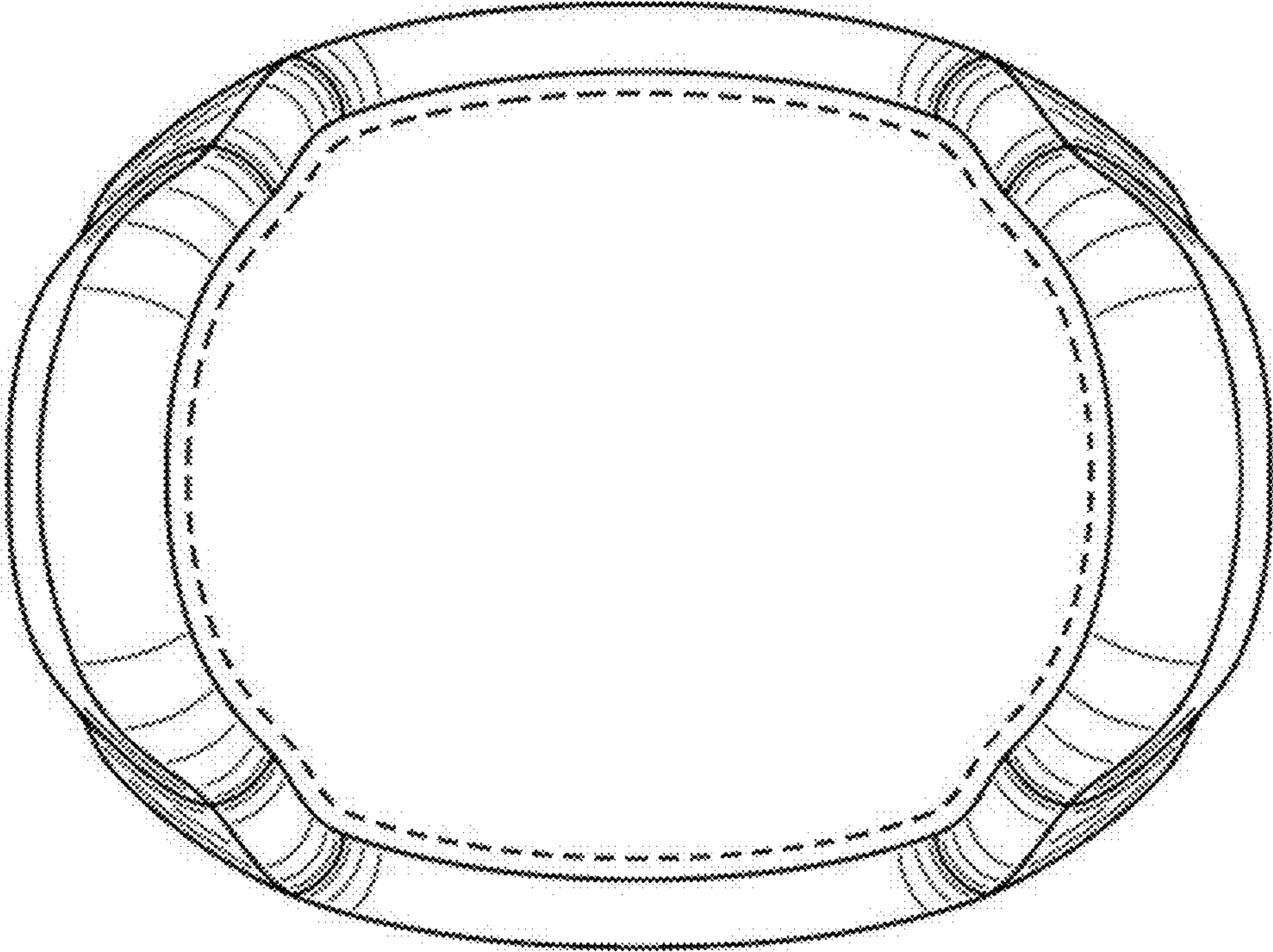

FIG. 7