



US00D821056S

(12) **United States Design Patent**
Nezat et al.

(10) **Patent No.:** **US D821,056 S**

(45) **Date of Patent:** **** Jun. 26, 2018**

(54) **ODOR BLOCKING PAIR OF TRUNKS**

(71) Applicants: **Louis Bayne Nezat**, Wilmer, AL (US);
Hunter Bayne Wyse, Wilmer, AL (US)

(72) Inventors: **Louis Bayne Nezat**, Wilmer, AL (US);
Hunter Bayne Wyse, Wilmer, AL (US)

(**) Term: **15 Years**

(21) Appl. No.: **29/577,559**

(22) Filed: **Sep. 14, 2016**

Related U.S. Application Data

(63) Continuation-in-part of application No. 29/506,447,
filed on Oct. 15, 2014, now abandoned.

(51) **LOC (11) Cl.** **02-01**

(52) **U.S. Cl.**
USPC **D2/712**

(58) **Field of Classification Search**
USPC D2/700, 705, 712, 713, 714, 715, 716,
D2/731, 738, 742

CPC A41B 9/00; A41B 9/02; A41B 9/04; A41B
9/001; A41B 9/004; A41B 9/12; A41D
7/00; A41D 7/005; A61F 13/496; A61F
13/4963; A61F 13/49007; A61F
13/49009; A61F 13/49014; A61F 13/8405
See application file for complete search history.

(56) **References Cited**

U.S. PATENT DOCUMENTS

1,425,794 A * 8/1922 Sacks A41B 9/04
2/407
D137,924 S * 5/1944 Brodigan D2/712
2,437,511 A * 3/1948 Donaldson A41B 9/04
2/407
2,459,043 A * 1/1949 Owenby A41B 9/02
2/401

2,960,987 A * 11/1960 Rockwell A41C 1/00
2/DIG. 9
D192,915 S * 5/1962 Bayer D2/704
3,213,855 A * 10/1965 Greco A41C 1/003
450/104
D207,162 S * 3/1967 Glines D2/704
D208,247 S * 8/1967 Blenenfeld D2/704
3,946,579 A * 3/1976 Heinig A41B 9/004
66/177
4,449,254 A * 5/1984 Fogg A41D 7/005
2/407
D401,328 S * 11/1998 Anderson D24/124
6,817,030 B2 * 11/2004 Desai A41B 9/00
2/67
D537,525 S * 2/2007 Buchanan D2/712
D631,540 S * 1/2011 Venable D24/126
D735,444 S * 8/2015 Harris D2/712
9,163,906 B2 * 10/2015 Hirsch F41H 1/02
D761,520 S * 7/2016 Klein D2/712

(Continued)

Primary Examiner — Thomas Johannes

Assistant Examiner — Jasmine Mlinarcik

(74) *Attorney, Agent, or Firm* — AdamsIP, LLC; J.
Hunter Adams; Gary N. Stewart

(57) **CLAIM**

The omental design for an odor blocking pair of trunks, as
shown.

DESCRIPTION

FIG. 1 is a front perspective view of an odor blocking pair
of trunks incorporating our new design with the wearer's left
side adhesive strips disengaged;
FIG. 2 is a back perspective view thereof;
FIG. 3 is a front elevation view of the odor blocking garment
with the adhesive strips engaged;
FIG. 4 is a back elevation view thereof;
FIG. 5 is a top plan view thereof;
FIG. 6 is a bottom plan view thereof; and,
FIG. 7 is a side elevation view thereof.

1 Claim, 3 Drawing Sheets

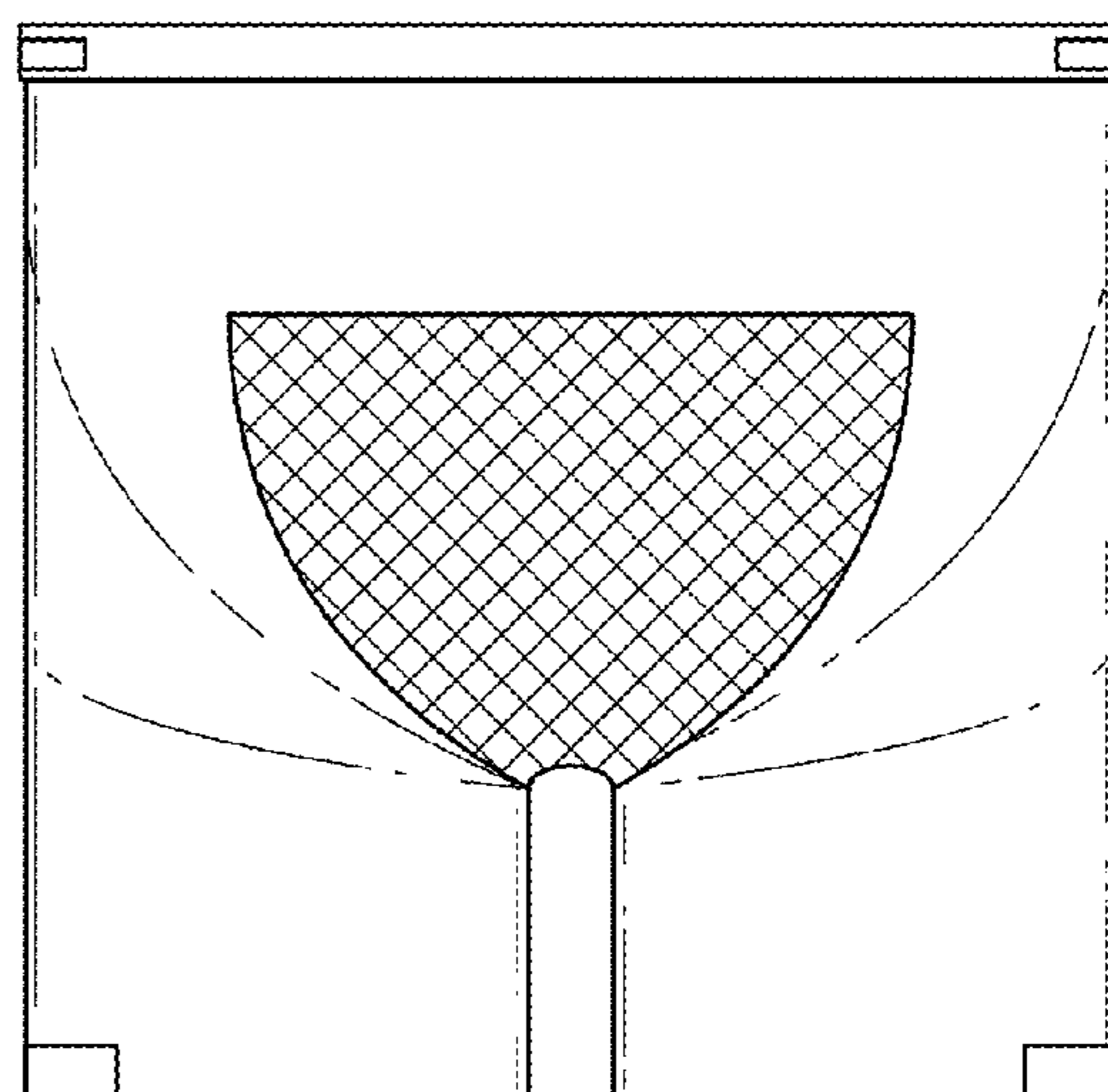
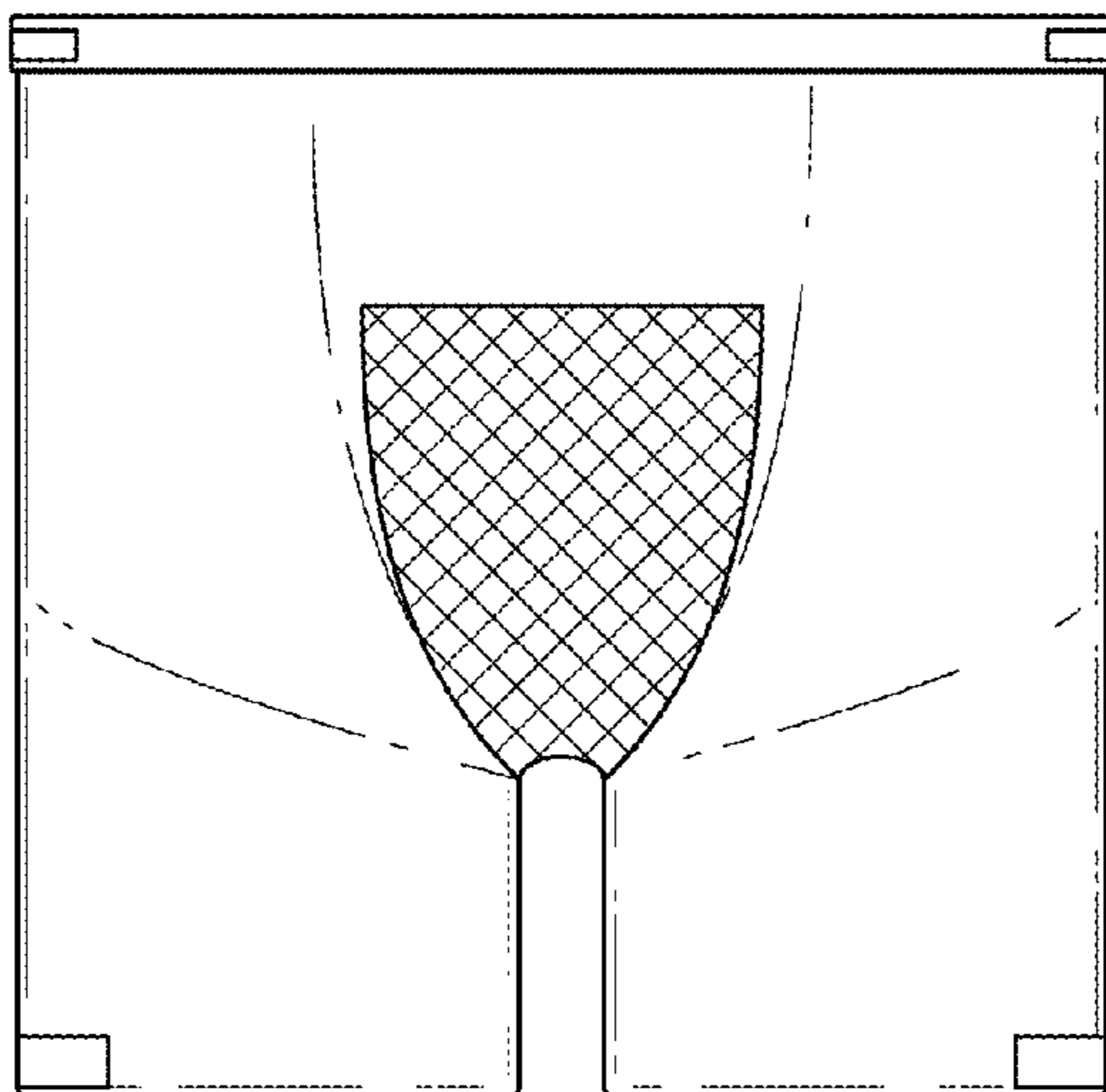

(56)

References Cited

U.S. PATENT DOCUMENTS

2006/0005301 A1* 1/2006 Taylor A41B 9/02
2/403
2007/0032771 A1* 2/2007 Abed A41B 9/001
604/385.22
2008/0229487 A1* 9/2008 Kweon A41B 9/001
2/405
2016/0073697 A1* 3/2016 Nezat A41B 17/00
2/113

* cited by examiner

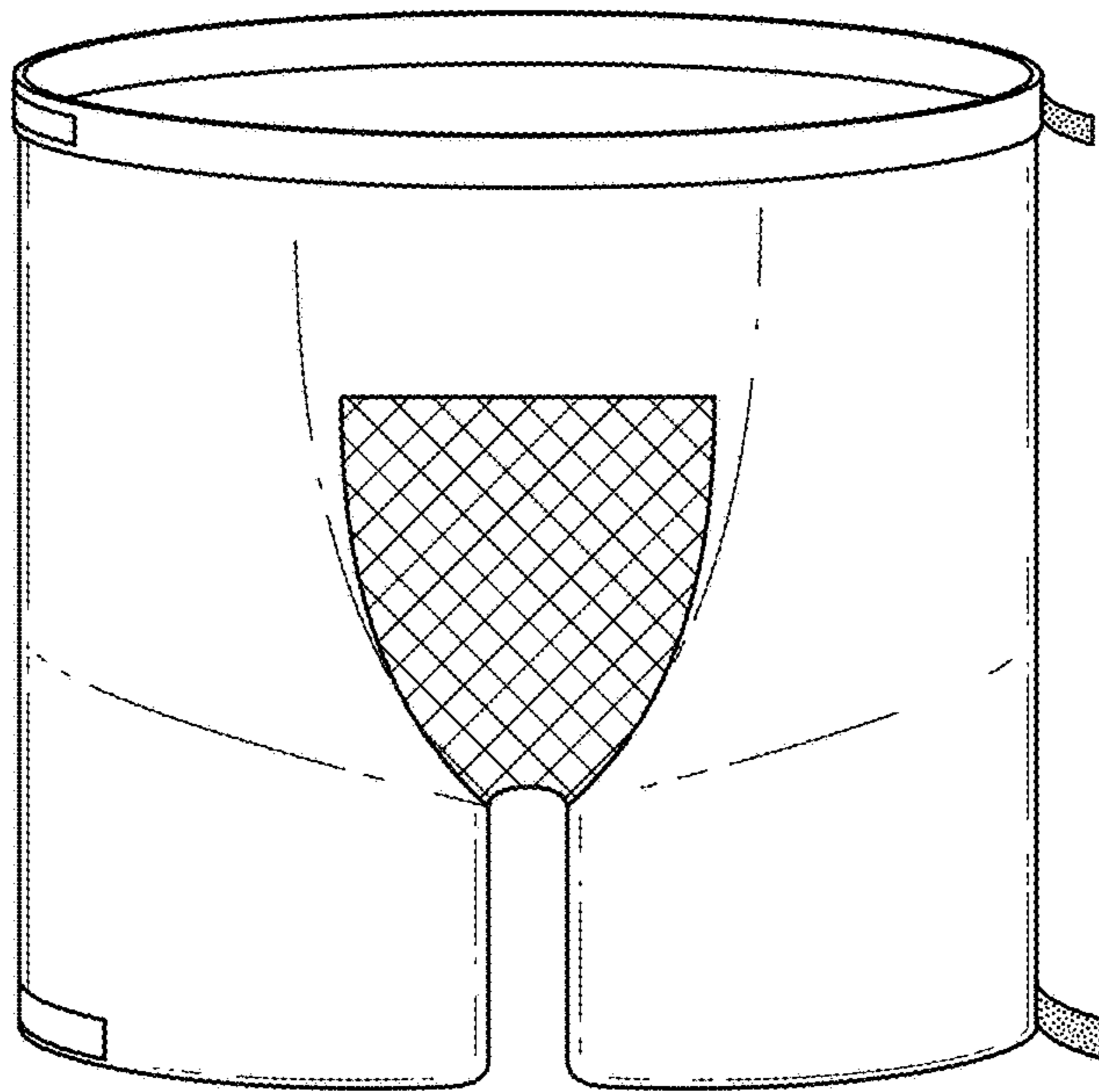

FIG. 1

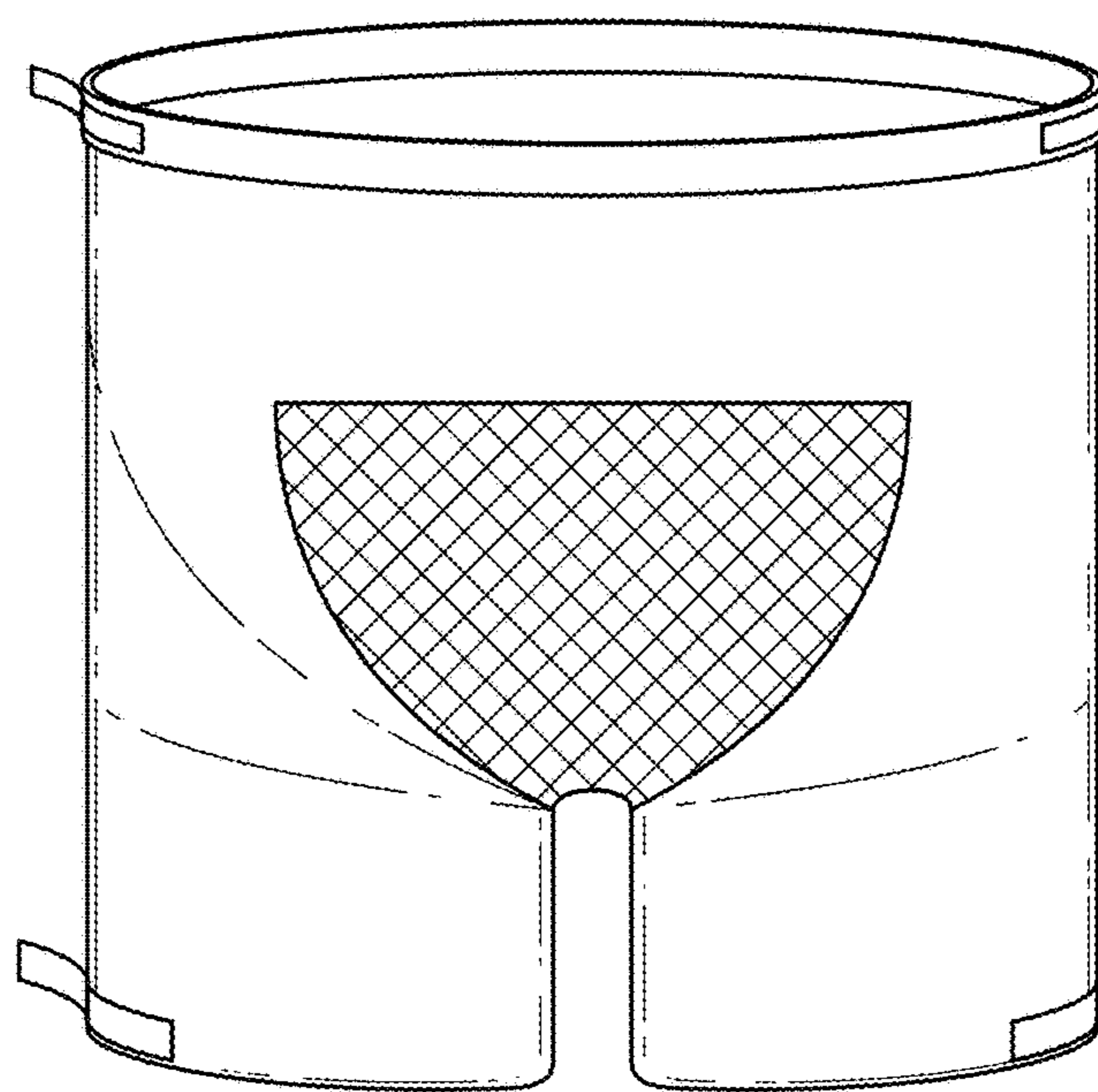

FIG. 2

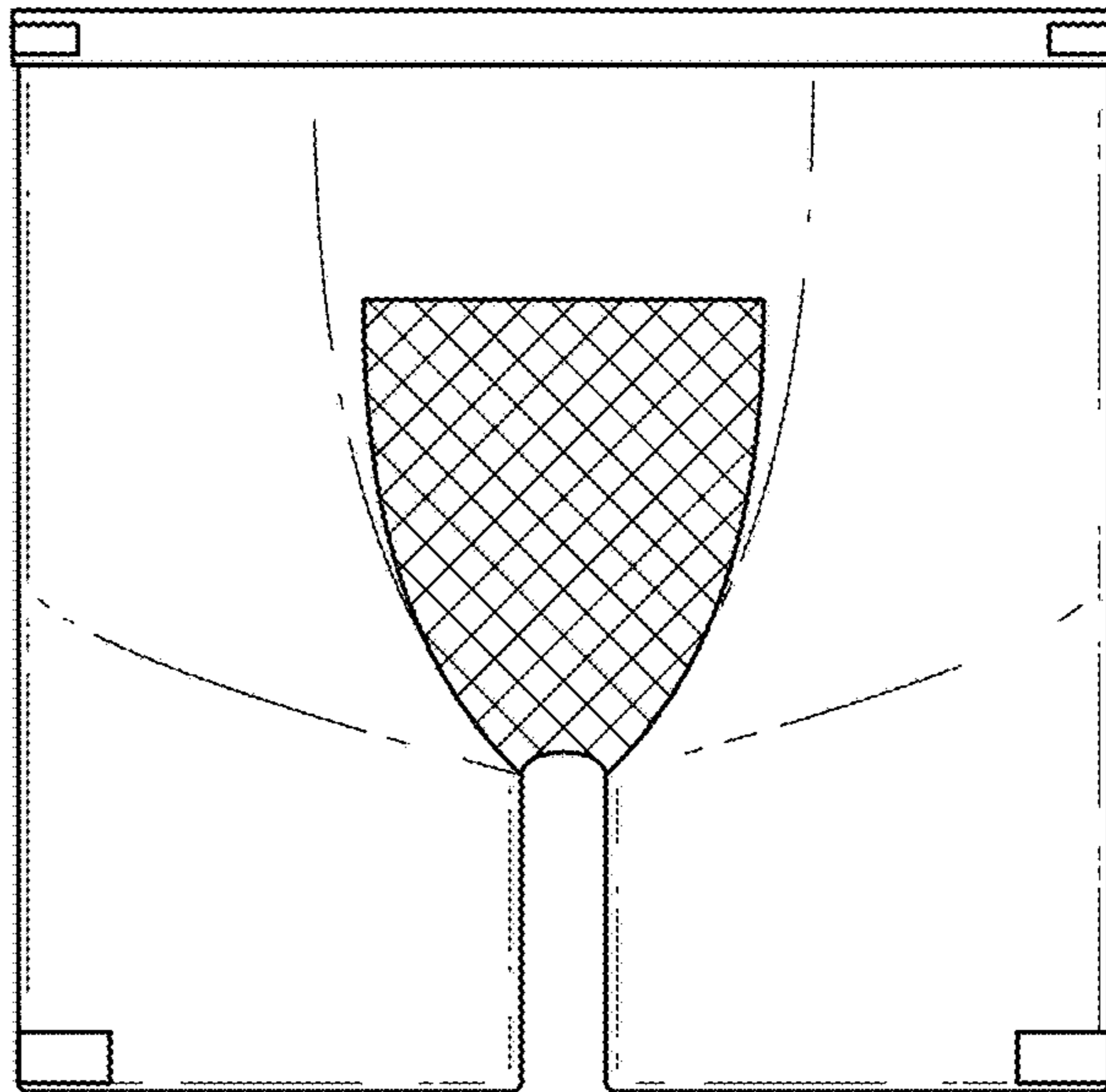

FIG. 3

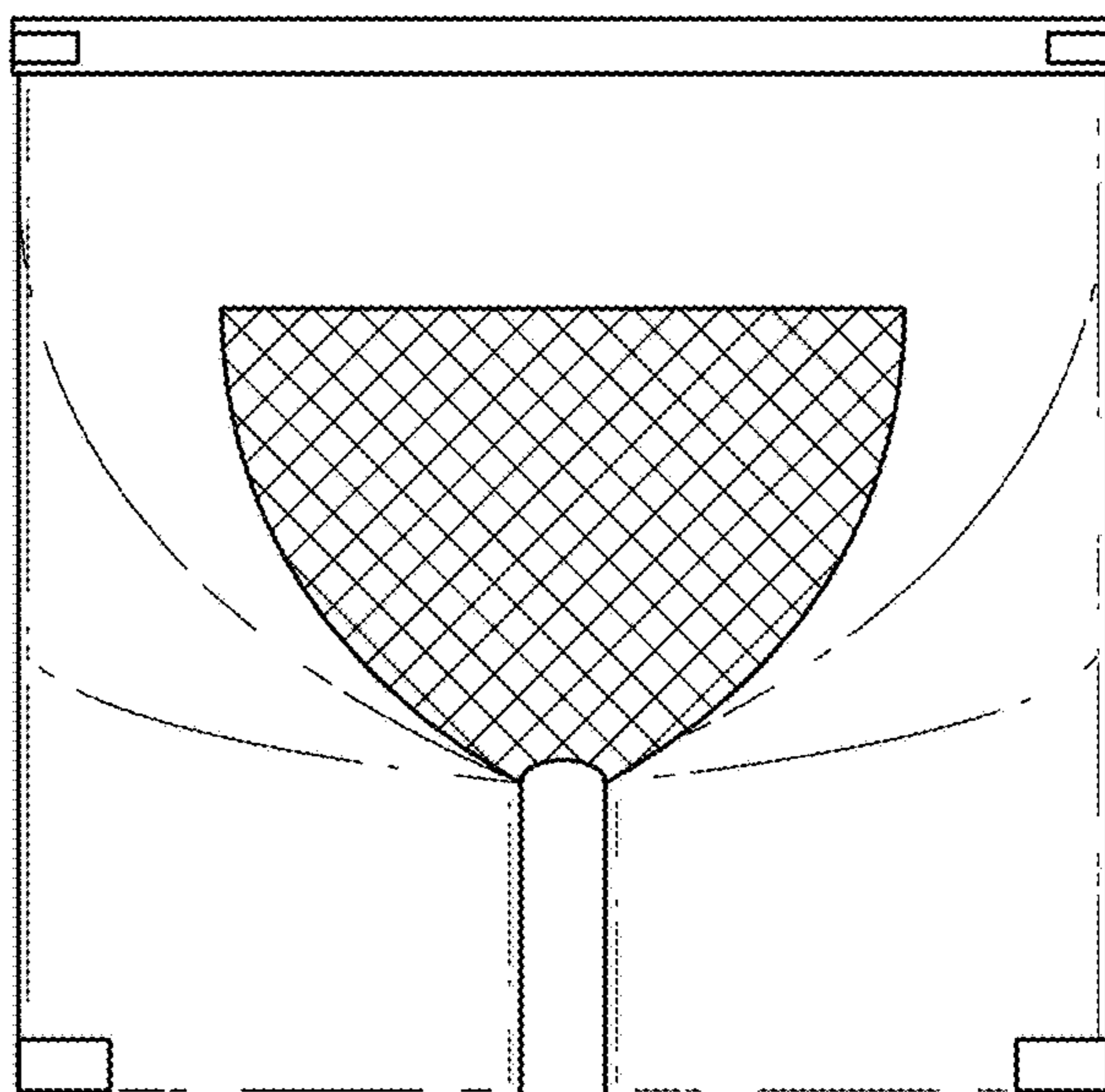

FIG. 4

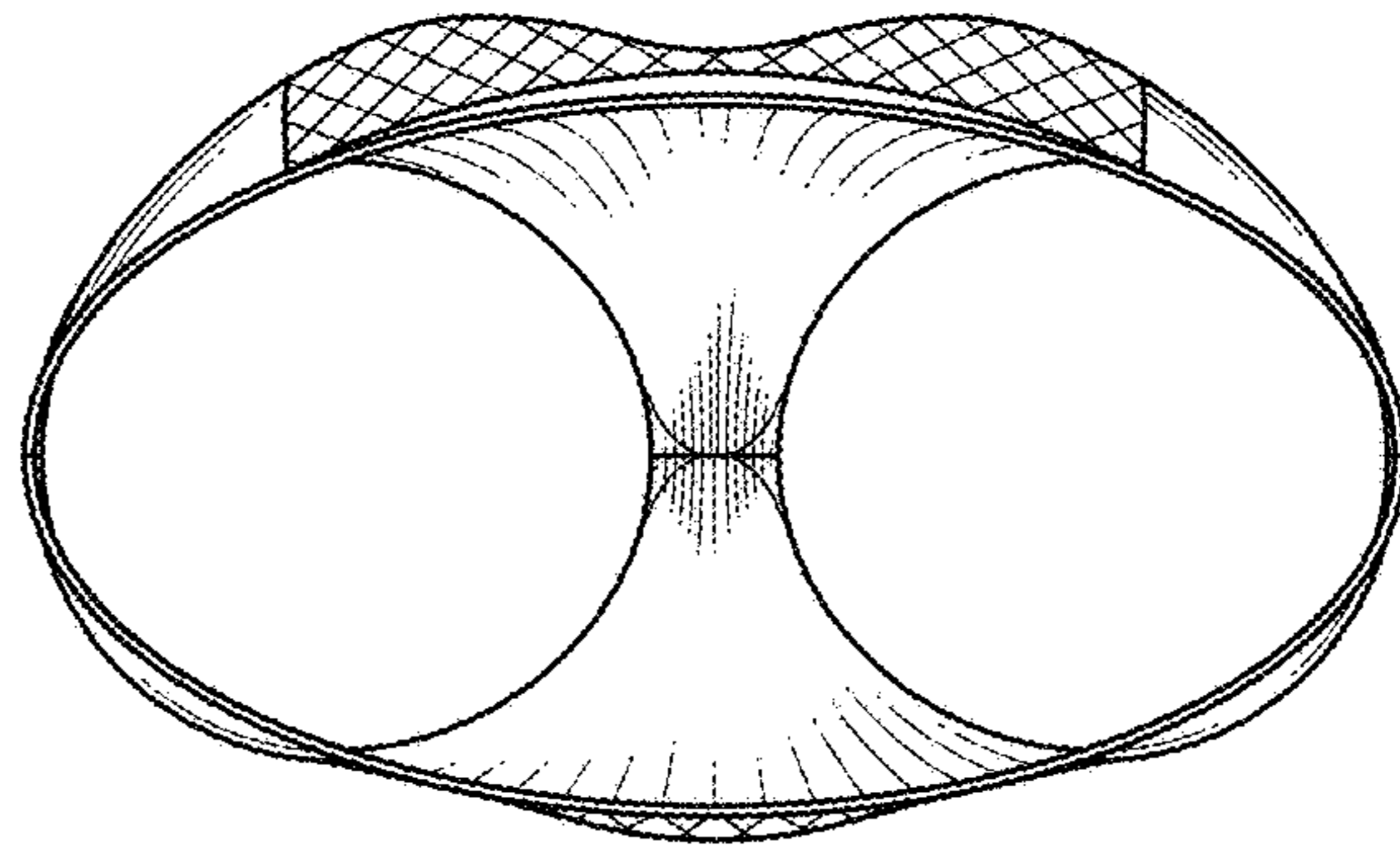

FIG. 5

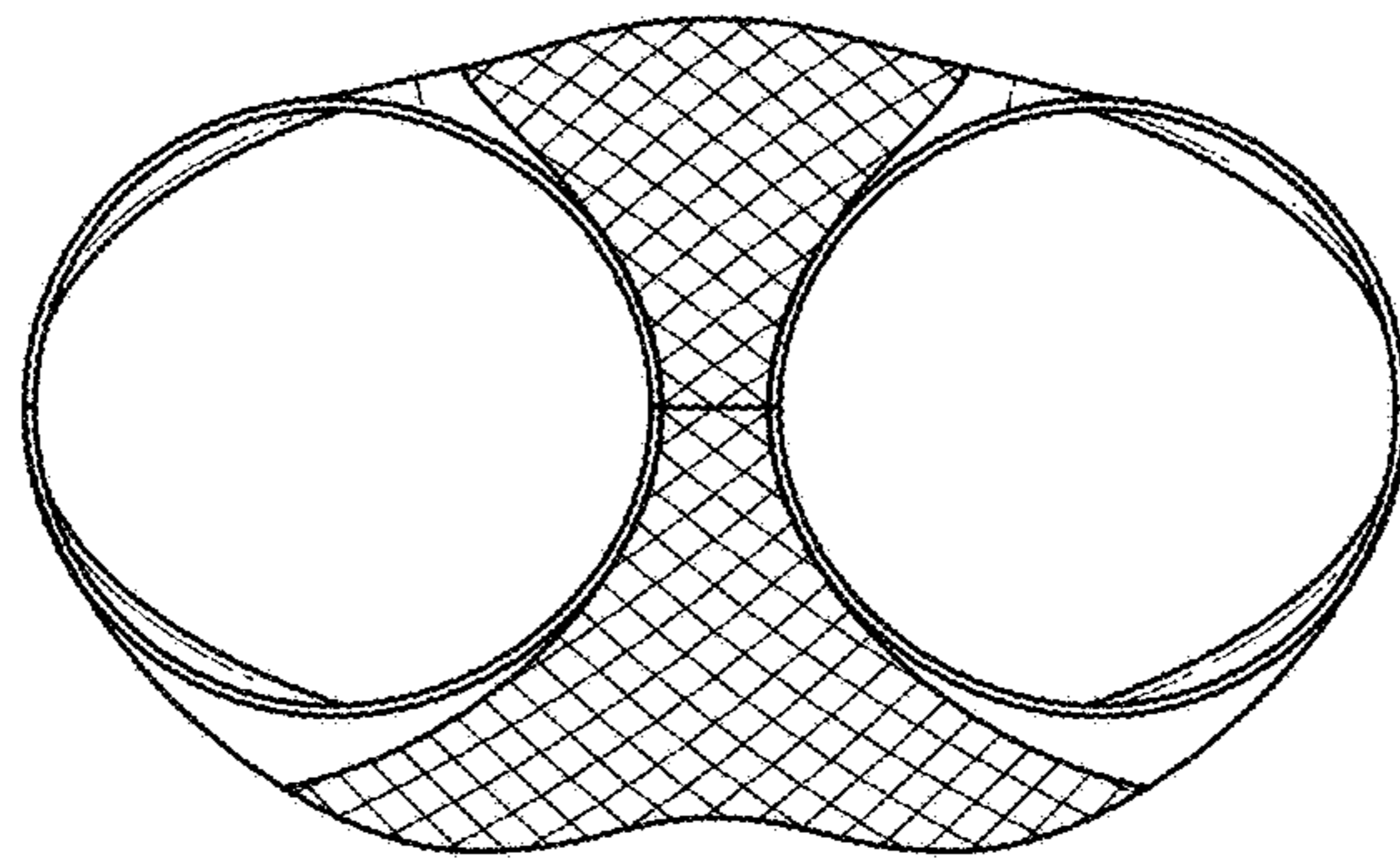

FIG. 6

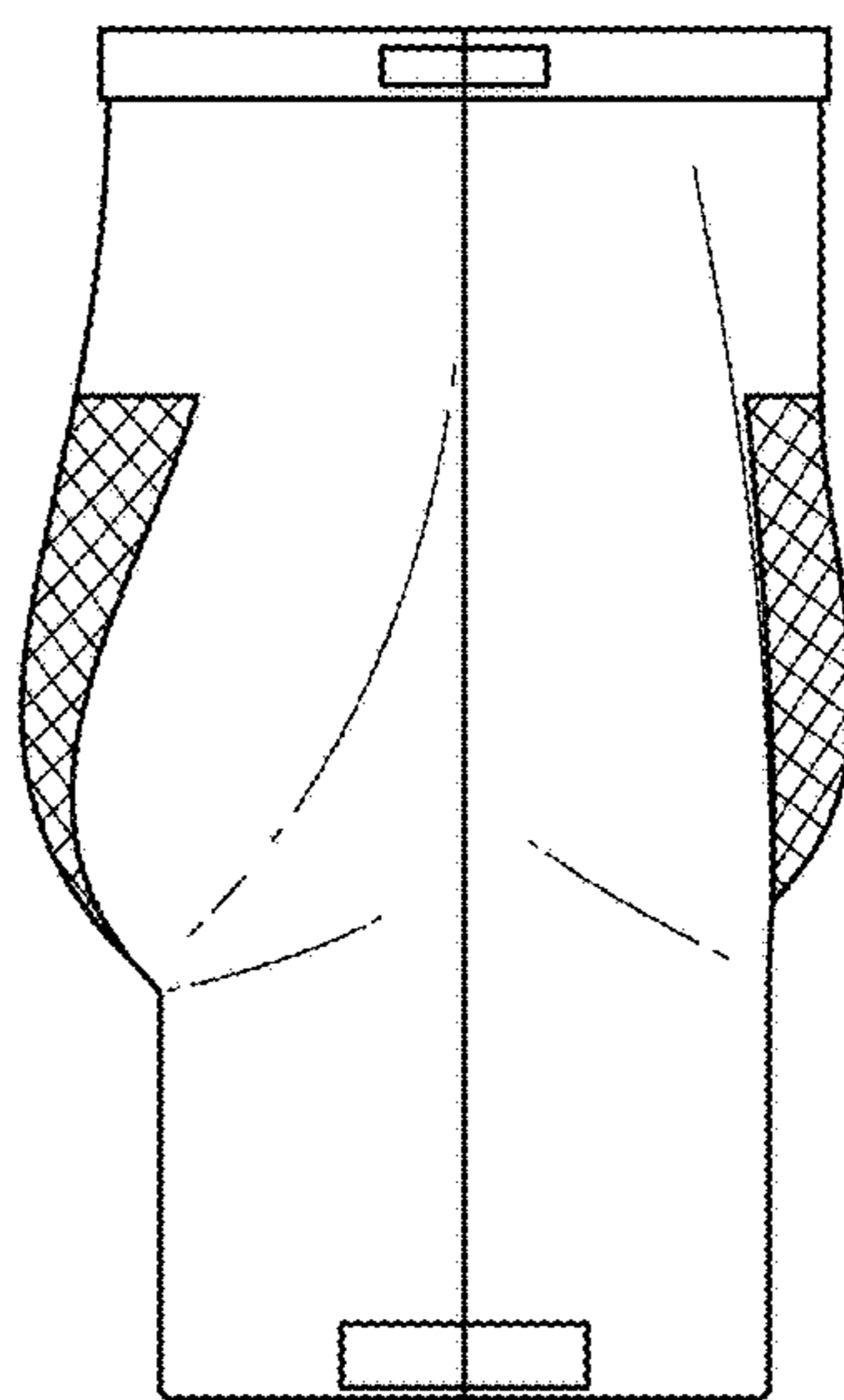

FIG. 7