

US00D821043S

(12) **United States Design Patent**
Yoo et al.

(10) **Patent No.:** **US D821,043 S**
(45) **Date of Patent:** **** Jun. 19, 2018**

(54) **CLOTHES DRYER MACHINE**
(71) Applicant: **LG ELECTRONICS INC.**, Seoul (KR)
(72) Inventors: **Taewoo Yoo**, Seoul (KR); **Junghwan Lee**, Seoul (KR); **Kyungah Lee**, Seoul (KR); **Hyewon Kim**, Seoul (KR); **Jeaseok Seong**, Seoul (KR)
(73) Assignee: **LG Electronics Inc.**, Seoul (KR)
(**) Term: **15 Years**

(21) Appl. No.: **35/502,042**
(22) Filed: **Jun. 3, 2016**

(80) **Hague Agreement Data**
Int. Filing Date: **Jun. 3, 2016**
Int. Reg. No.: **DM/091936**
Int. Reg. Date: **Jun. 3, 2016**
Int. Reg. Pub. Date: **Dec. 9, 2016**

(30) **Foreign Application Priority Data**
Dec. 3, 2015 (KR) 30-2015-0061624
(51) **LOC (11) Cl.** **15-05**
(52) **U.S. Cl.**
USPC **D32/8**
CPC **D06F 33/02** (2013.01)
(58) **Field of Classification Search**
USPC D32/1-10, 25-29
CPC D06F 33/02; D06F 2204/065; D06F 25/00;
D06F 35/006; D06F 37/28; D06F 39/14;
D06F 58/00; D06F 58/02; D06F 58/04;
D06F 58/20; D06F 19/042; D06F 23/04
See application file for complete search history.

(56) **References Cited**
U.S. PATENT DOCUMENTS
4,682,424 A * 7/1987 Irving D06F 58/10
211/123

5,305,484 A * 4/1994 Fitzpatrick D06F 73/02
223/70
5,555,640 A * 9/1996 Ou A47L 19/00
211/133.6
7,235,109 B2 * 6/2007 Kleker D06F 17/04
34/106
D574,115 S * 7/2008 Jeon D32/9
D637,369 S * 5/2011 Mangano D32/8
D638,592 S * 5/2011 Suh D32/8
D640,430 S * 6/2011 Jee D32/6
D643,165 S * 8/2011 Song D32/8
D644,383 S * 8/2011 Mangano D32/8
8,058,588 B2 * 11/2011 Gagas A47J 36/2483
219/400
D659,917 S * 5/2012 Jeon D32/10
D663,495 S * 7/2012 Song D32/8
8,262,741 B2 * 9/2012 Estes C11D 11/0064
134/34

(Continued)

Primary Examiner — Richard E Chilcot
(74) *Attorney, Agent, or Firm* — Birch, Stewart, Kolasch & Birch, LLP

(57) **CLAIM**

The ornamental design for a clothes dryer machine, as shown and described.

DESCRIPTION

1. Clothes dryer machine
1.1 is a perspective view of a clothes dryer machine showing our new design;
1.2 is a front elevation view thereof;
1.3 is a rear elevation view thereof;
1.4 is a left-side elevation view thereof;
1.5 is a right-side elevation view thereof;
1.6 is a top plan view thereof;
1.7 is a bottom plan view thereof; and
1.8 is another perspective view thereof, in a use condition.
The broken lines in the drawing figures are included for the purpose of illustrating environment and form no part of the claimed design.

1 Claim, 8 Drawing Sheets

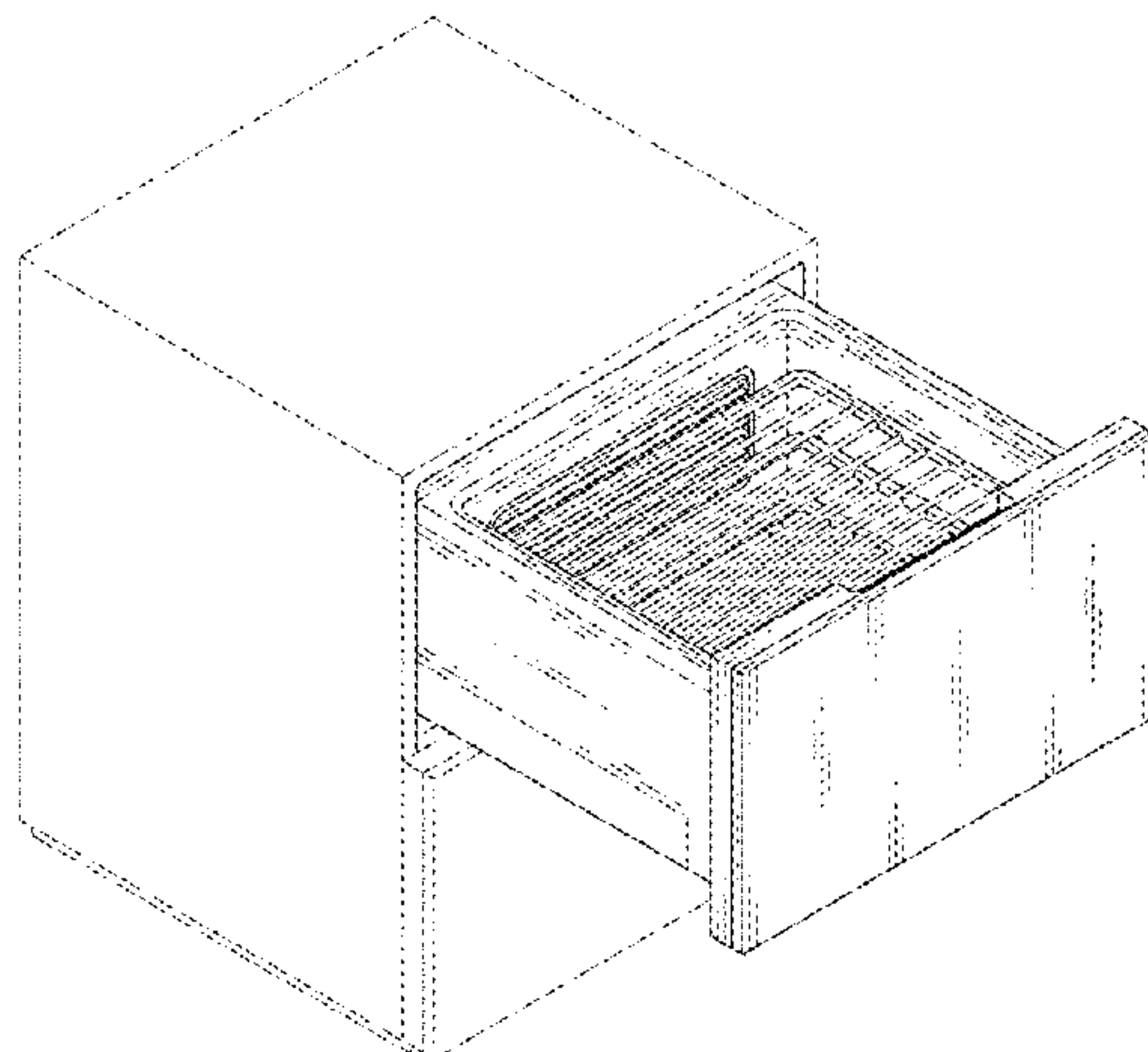

(56)

References Cited

U.S. PATENT DOCUMENTS

D669,236 S *	10/2012	Jeon	D32/25
D671,282 S *	11/2012	Jeon	D32/10
8,539,694 B2 *	9/2013	Moon	D06F 58/10 34/606
8,997,372 B2 *	4/2015	Cennon	D06F 58/20 34/201
D796,753 S *	9/2017	Prado Costa	D32/10
2004/0134087 A1 *	7/2004	Meyer	D06F 58/10 34/90

* cited by examiner

1.1

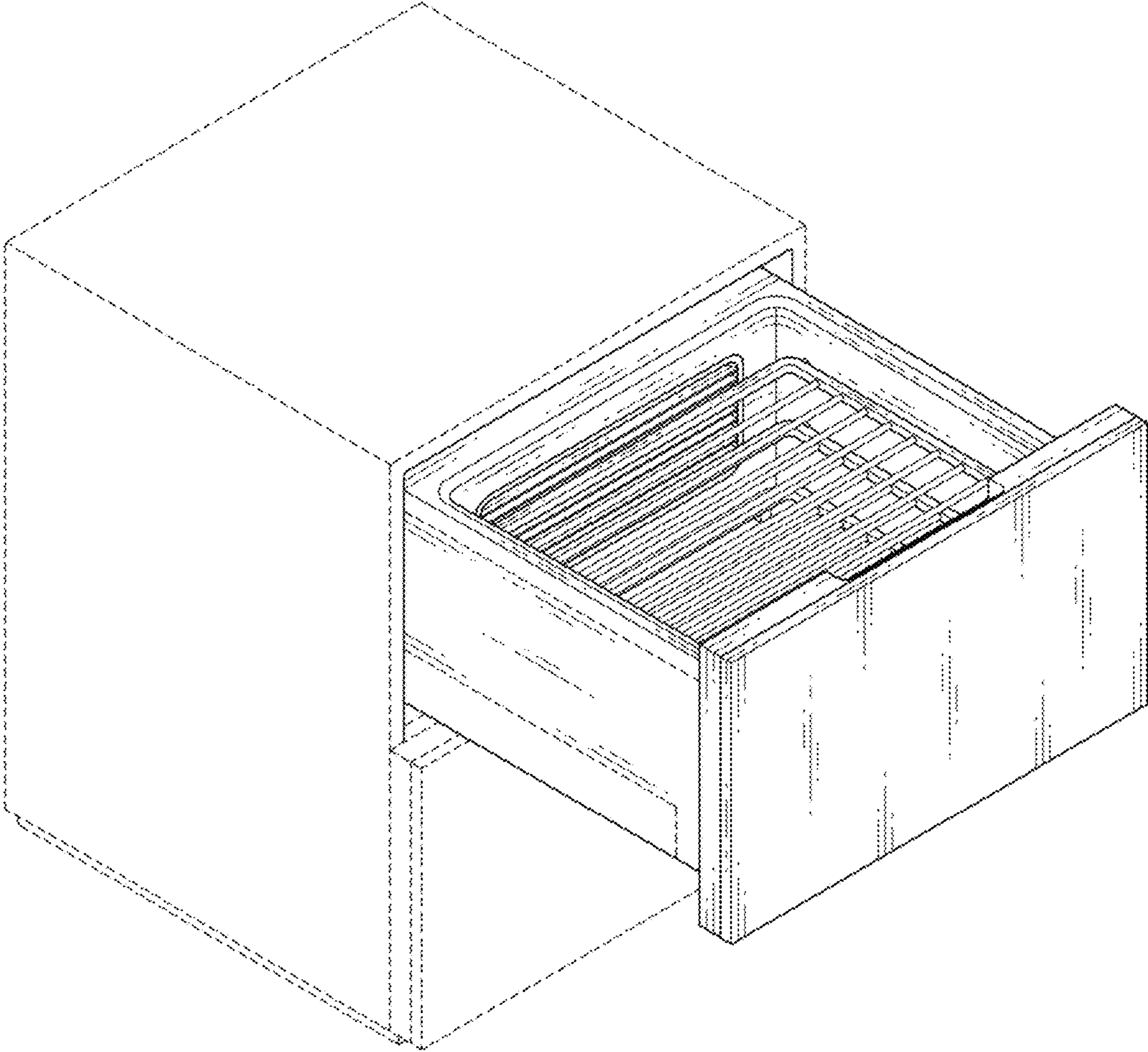

1.2

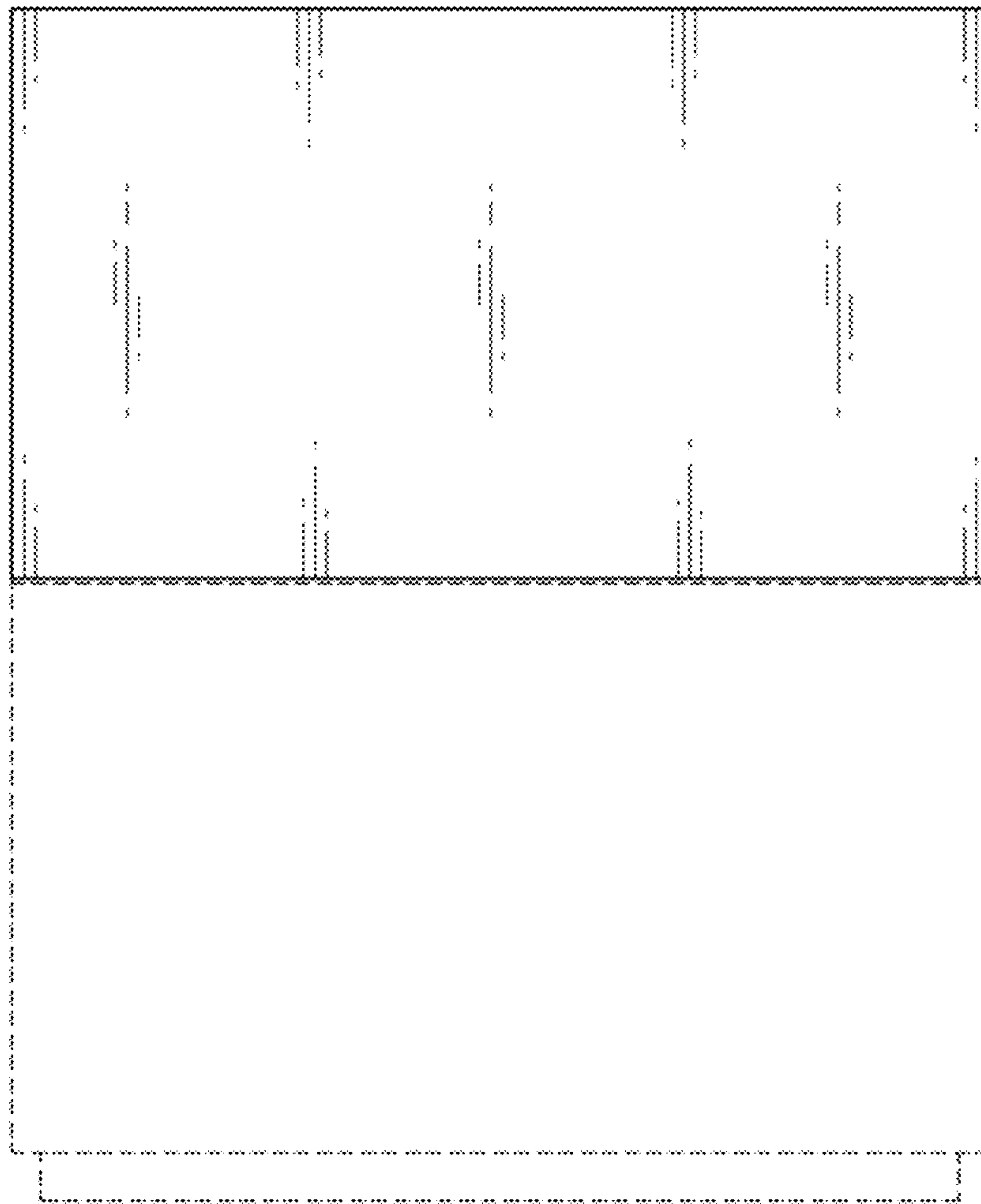

1.3



1.4

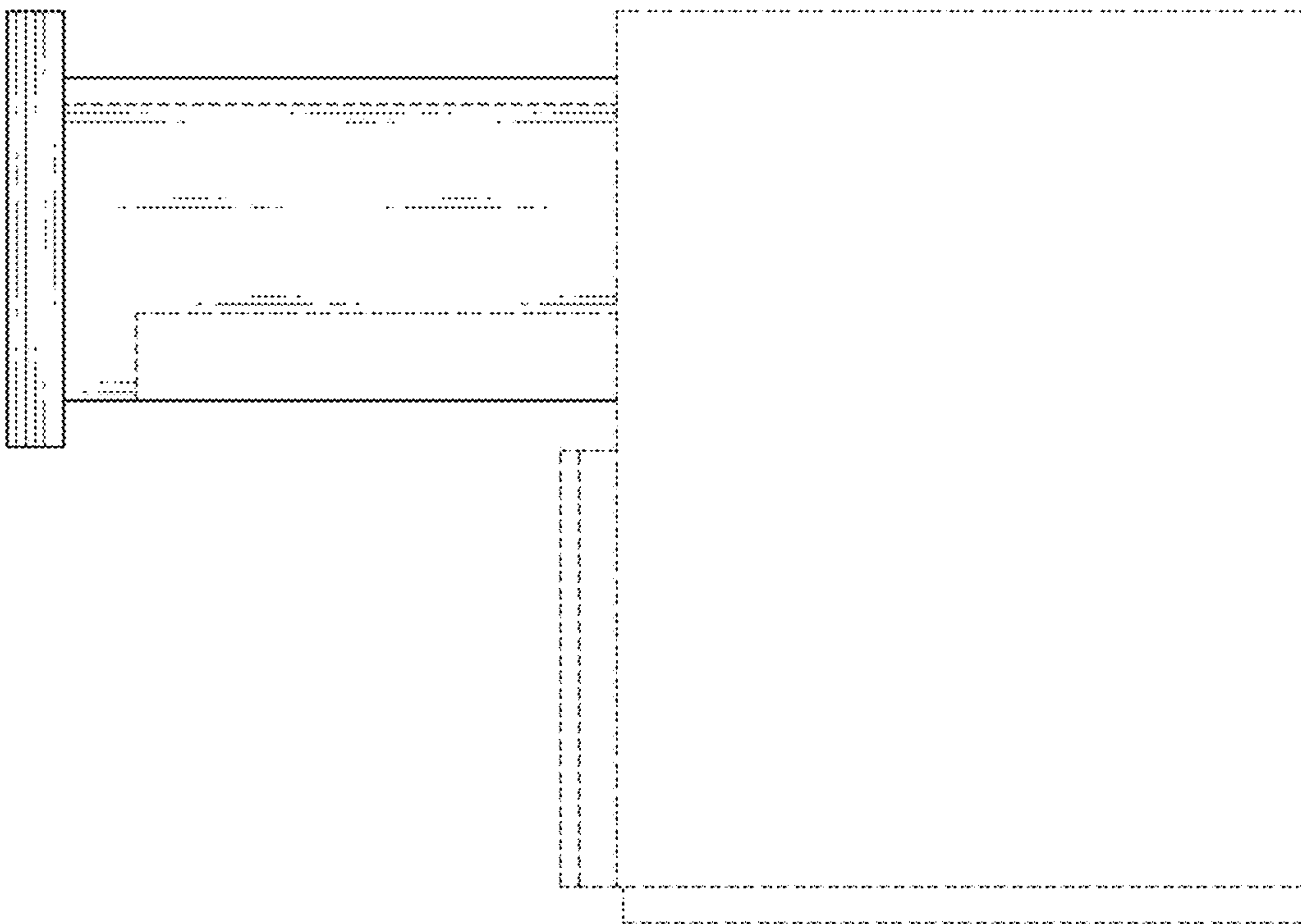

1.5

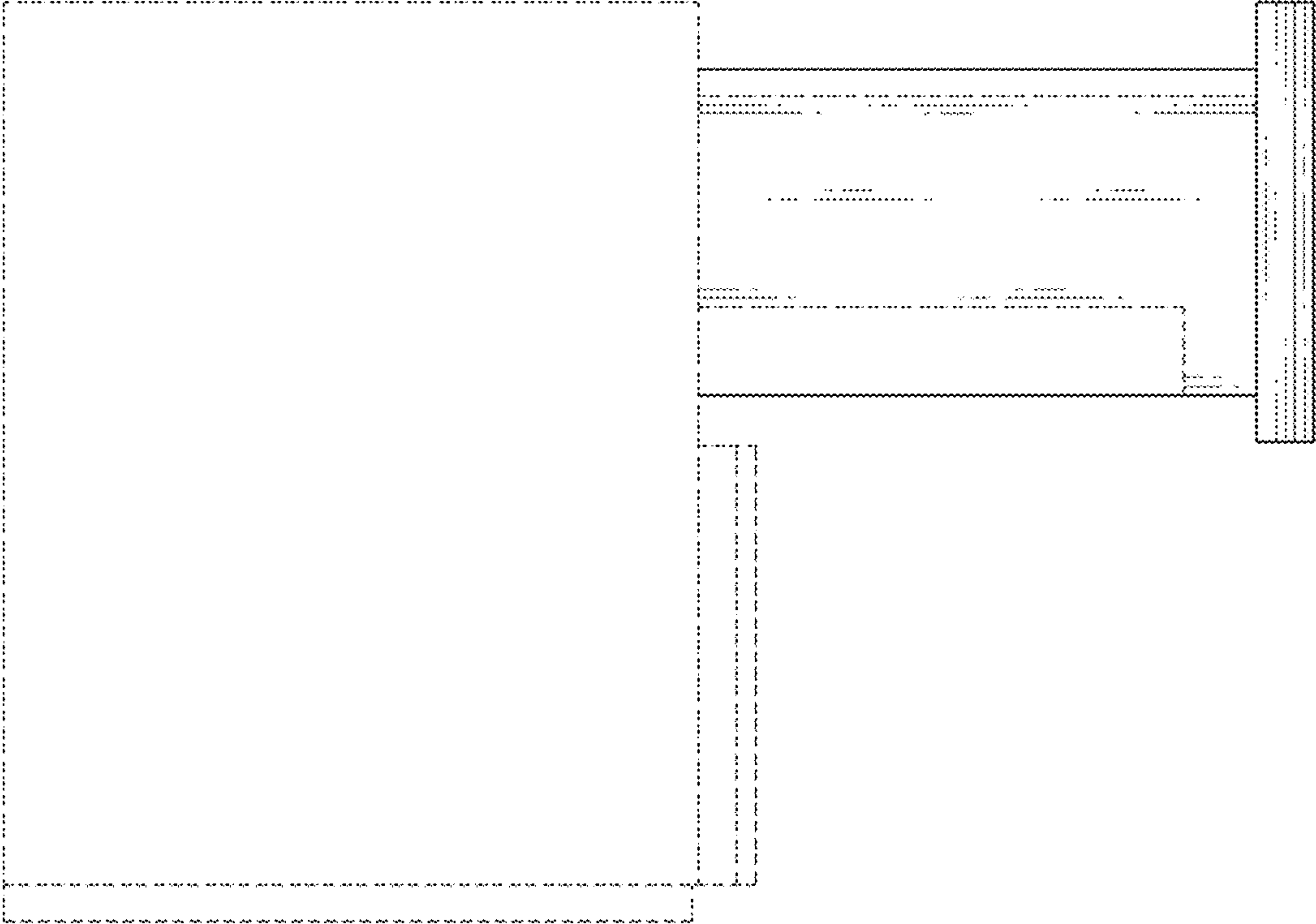

1.6

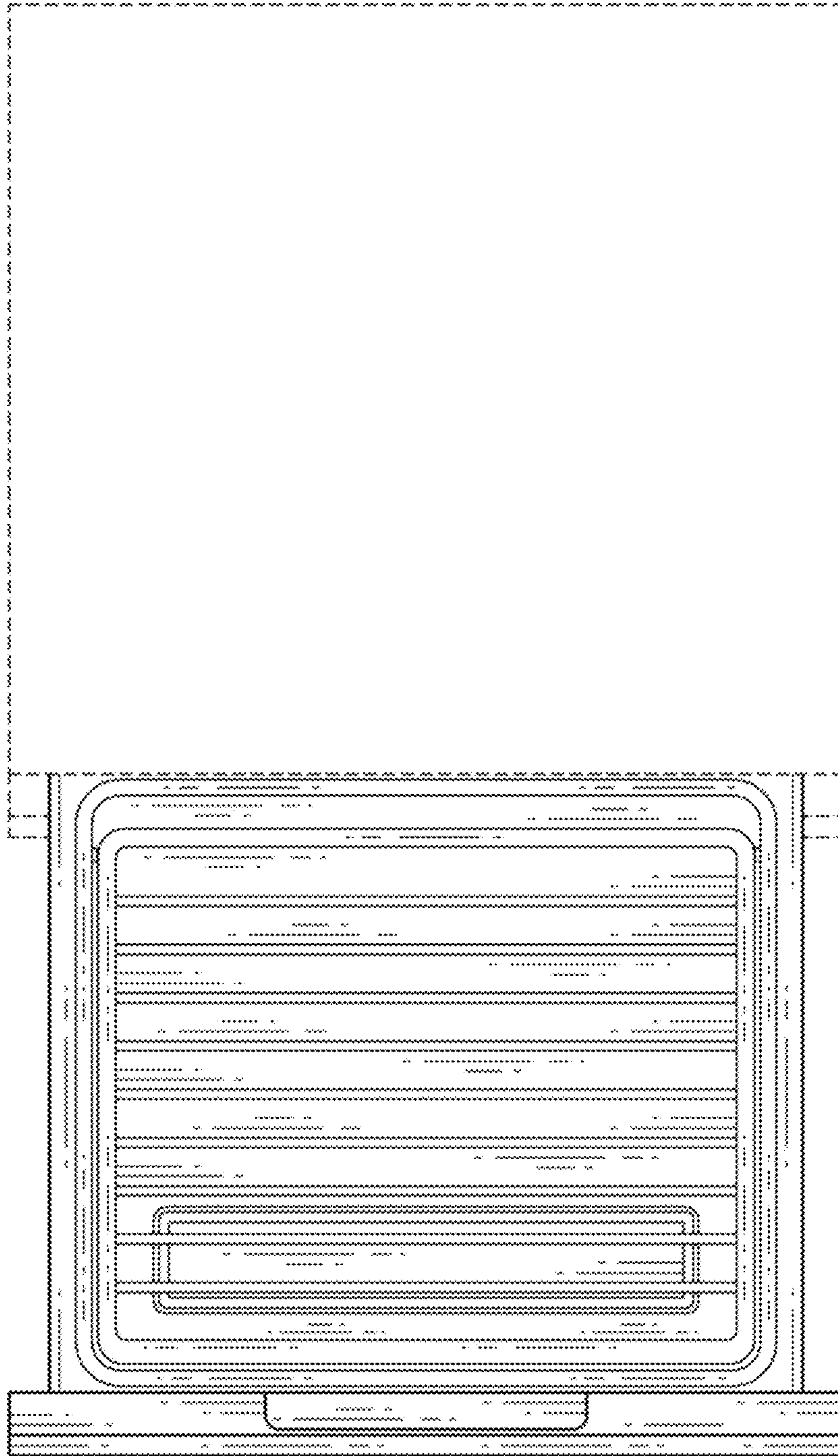

1.7

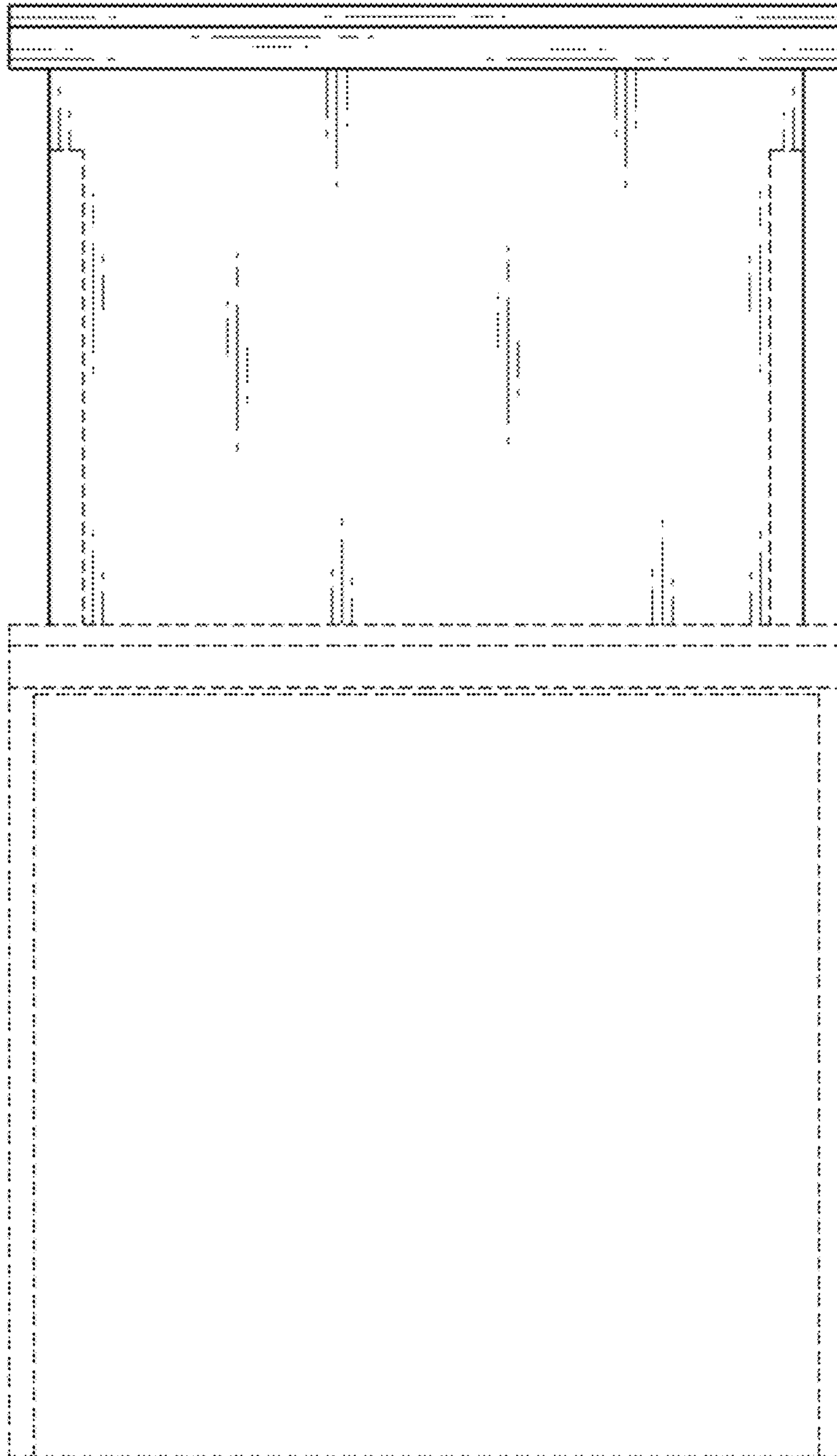

1.8

