



US00D821032S

(12) **United States Design Patent**
Prat-Pfister

(10) **Patent No.:** **US D821,032 S**
(45) **Date of Patent:** **** Jun. 19, 2018**

(54) **TWO HEAD DRY SHAVER**

(71) Applicant: **KONINKLIJKE PHILIPS N.V.**,
Eindhoven (NL)

(72) Inventor: **Gaël Louis Jacques Prat-Pfister**,
Amersfoort (NL)

(73) Assignee: **KONINKLIJKE PHILIPS N.V.**,
Eindhoven (NL)

(**) Term: **15 Years**

(21) Appl. No.: **35/502,583**

(22) Filed: **Sep. 7, 2016**

(80) **Hague Agreement Data**

Int. Filing Date: **Sep. 7, 2016**
Int. Reg. No.: **DM/092745**
Int. Reg. Date: **Sep. 7, 2016**
Int. Reg. Pub. Date: **Mar. 10, 2017**

(30) **Foreign Application Priority Data**

Mar. 20, 2016 (EM) 003036136

(51) **LOC (11) Cl.** **28-03**

(52) **U.S. Cl.**
USPC **D28/50**

(58) **Field of Classification Search**
USPC D28/44.1, 49-54
CPC B26B 19/00; B26B 19/02-19/107
See application file for complete search history.

(56) **References Cited**

U.S. PATENT DOCUMENTS

D383,247 S * 9/1997 Schulz D28/50
D423,719 S * 4/2000 De Visser D28/50

D608,053 S * 1/2010 Vetu D28/50
D675,778 S * 2/2013 Vetu D28/50
D675,779 S * 2/2013 Vetu D28/50
D695,961 S * 12/2013 Prat-Pfister D28/50
D695,962 S * 12/2013 Prat-Pfister D28/50
D758,660 S * 6/2016 Prat-Pfister D28/50

* cited by examiner

Primary Examiner — Zenia Bennett

(57) **CLAIM**

The ornamental design for a two head dry shaver, as shown and described.

DESCRIPTION

1.-2. Two head dry shaver
Fig. 1.1 is a front elevation view;
Fig. 1.2 is a perspective view;
Fig. 1.3 is a rear view;
Fig. 1.4 is a left side elevation view;
Fig. 1.5 is a right side elevation view;
Fig. 1.6 is a top plan view;
Fig. 1.7 is a bottom plan view;
Fig. 2.1 is a front elevation view;
Fig. 2.2 is a perspective view;
Fig. 2.3 is a rear view;
Fig. 2.4 is a left side elevation view;
Fig. 2.5 is a right side elevation view;
Fig. 2.6 is a top plan view;
Fig. 2.7 is a bottom plan view.

1 Claim, 14 Drawing Sheets

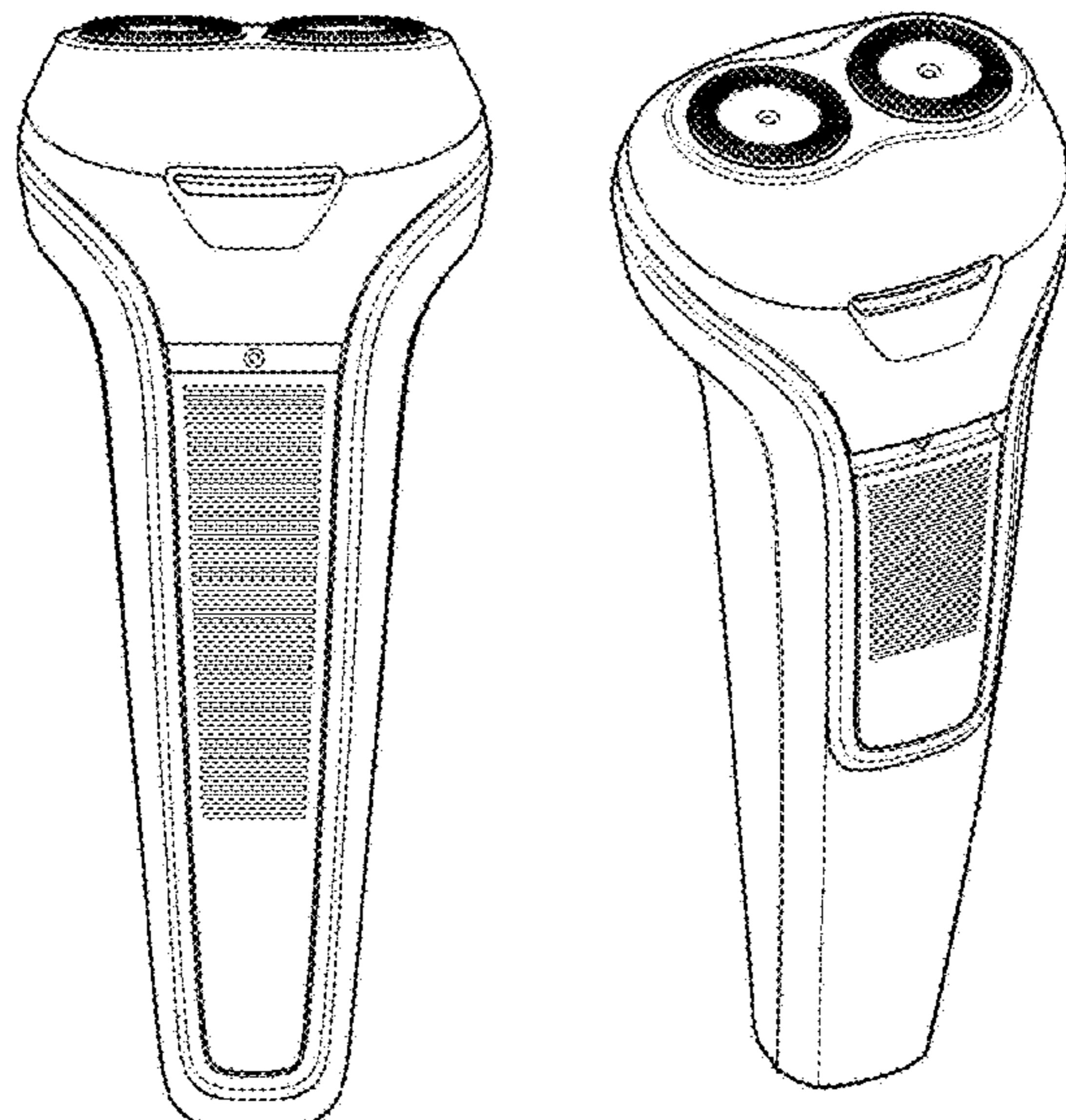

1.1

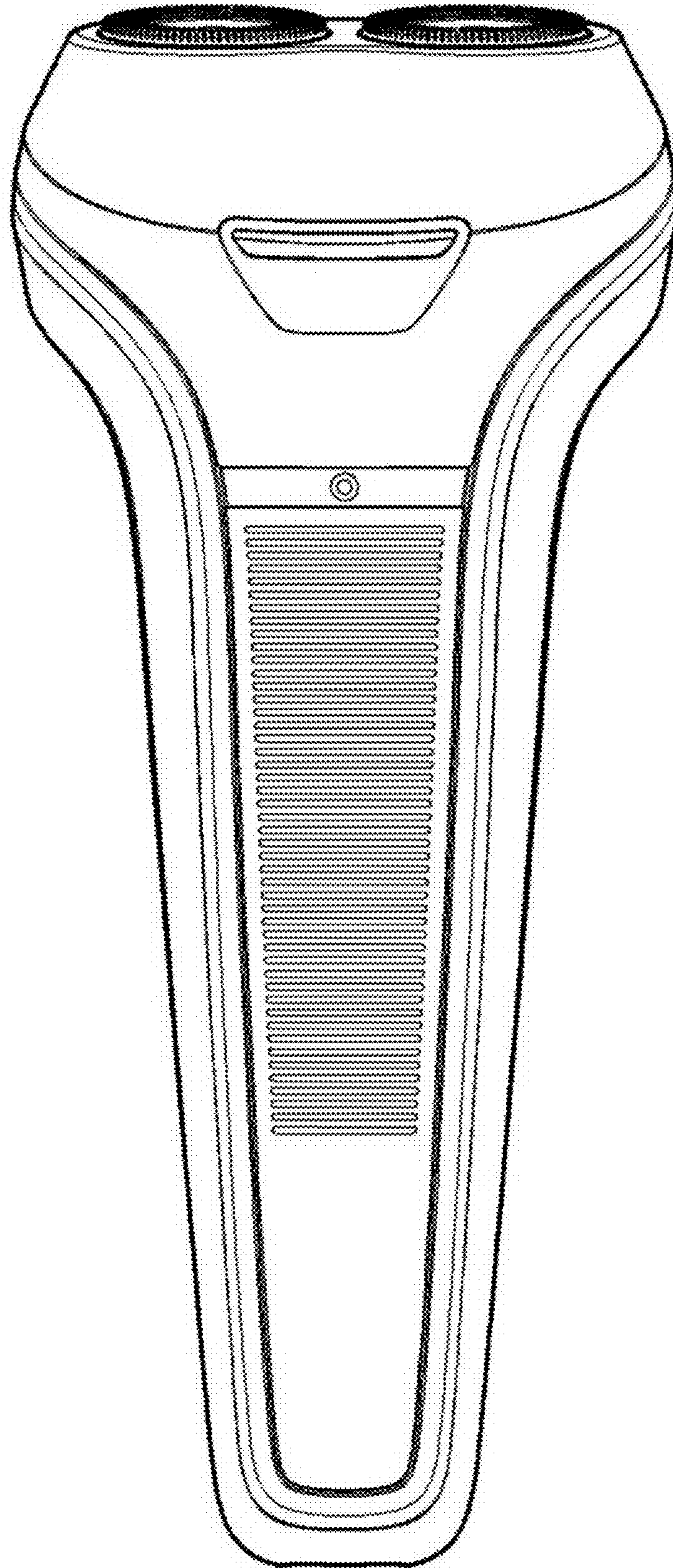

1.2

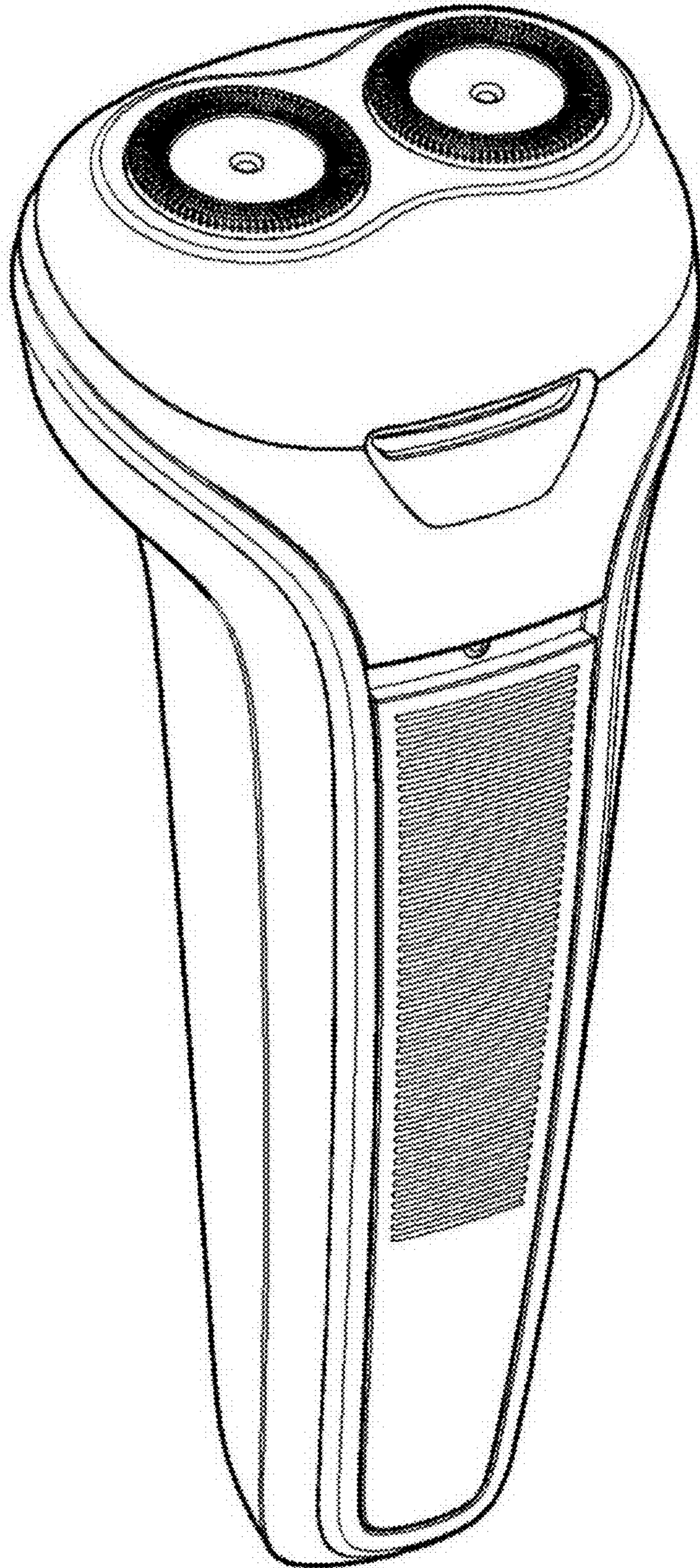

1.3

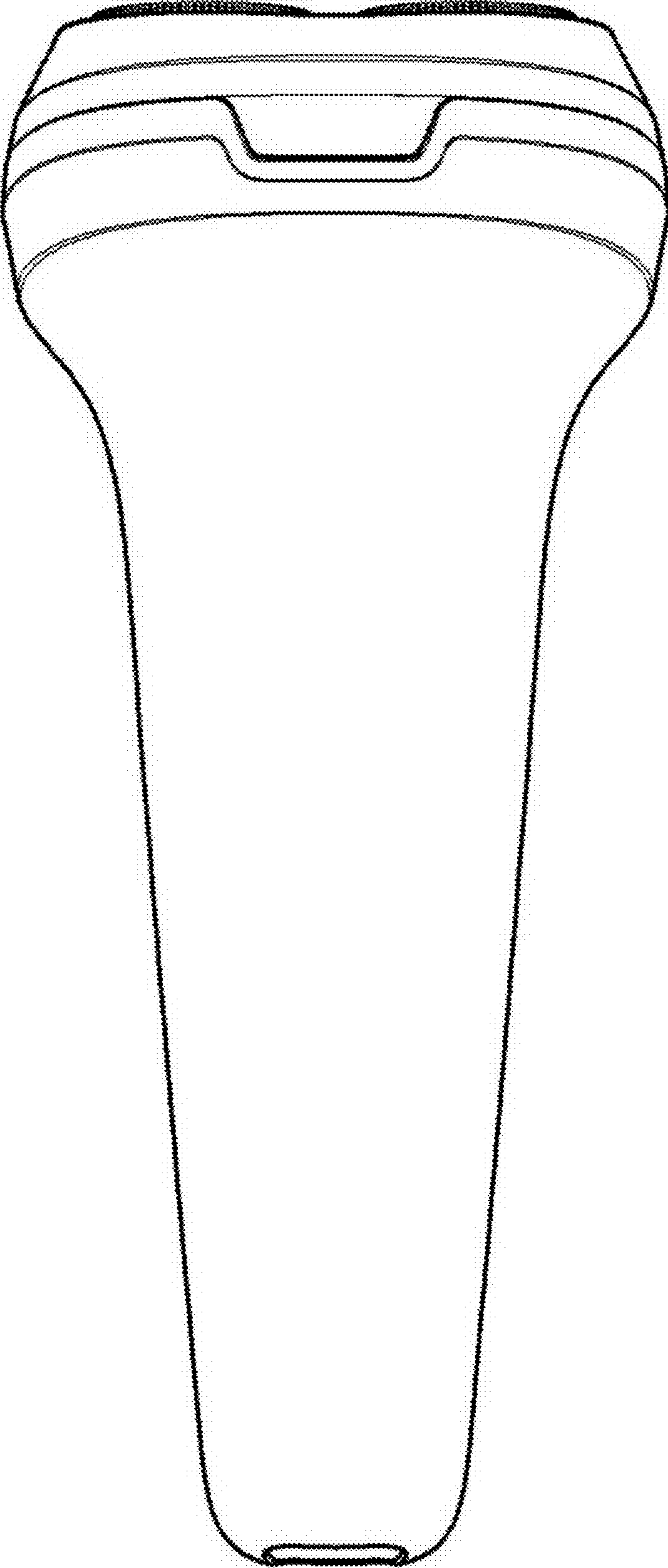

1.4

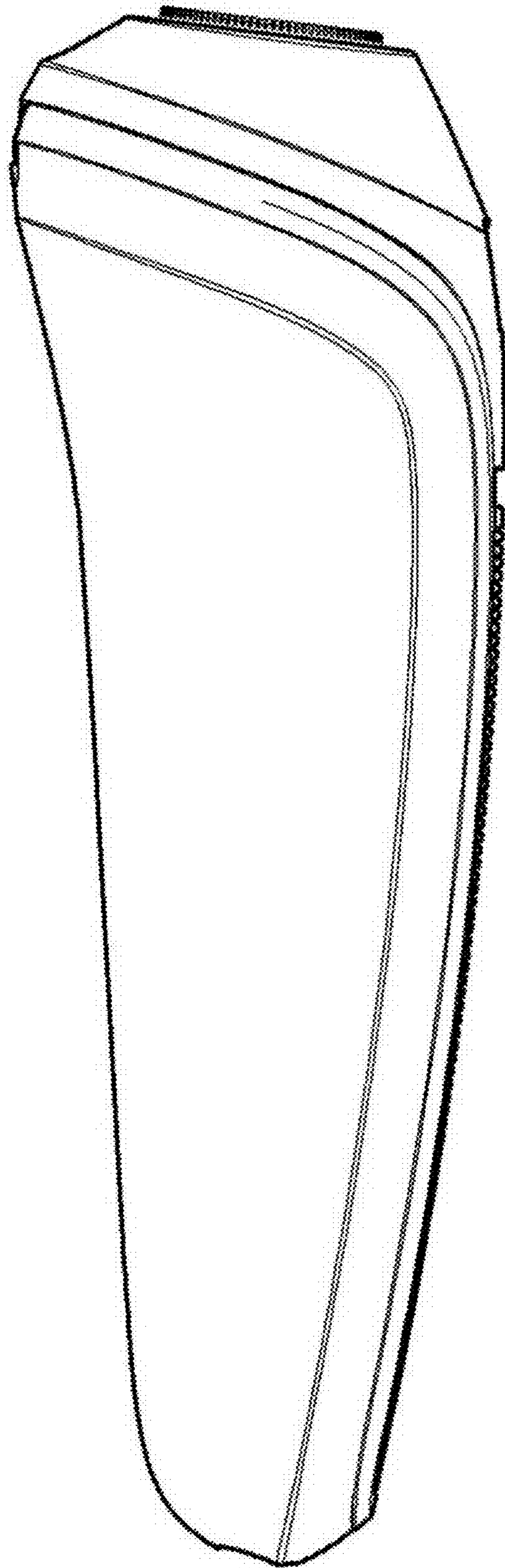

1.5

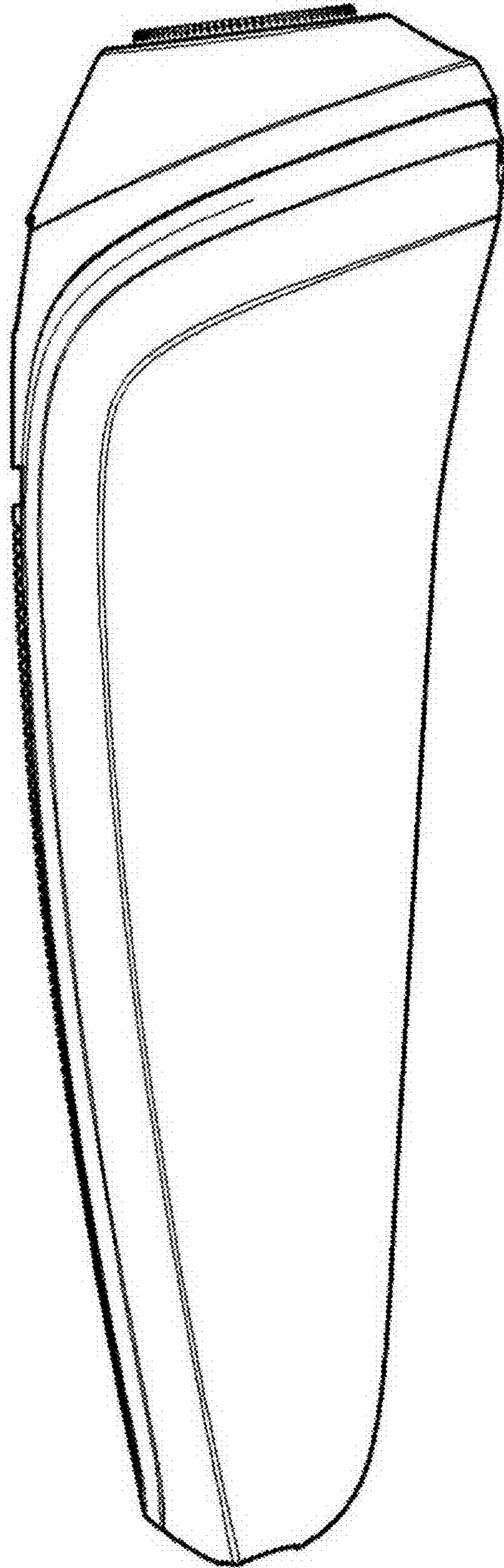

1.6

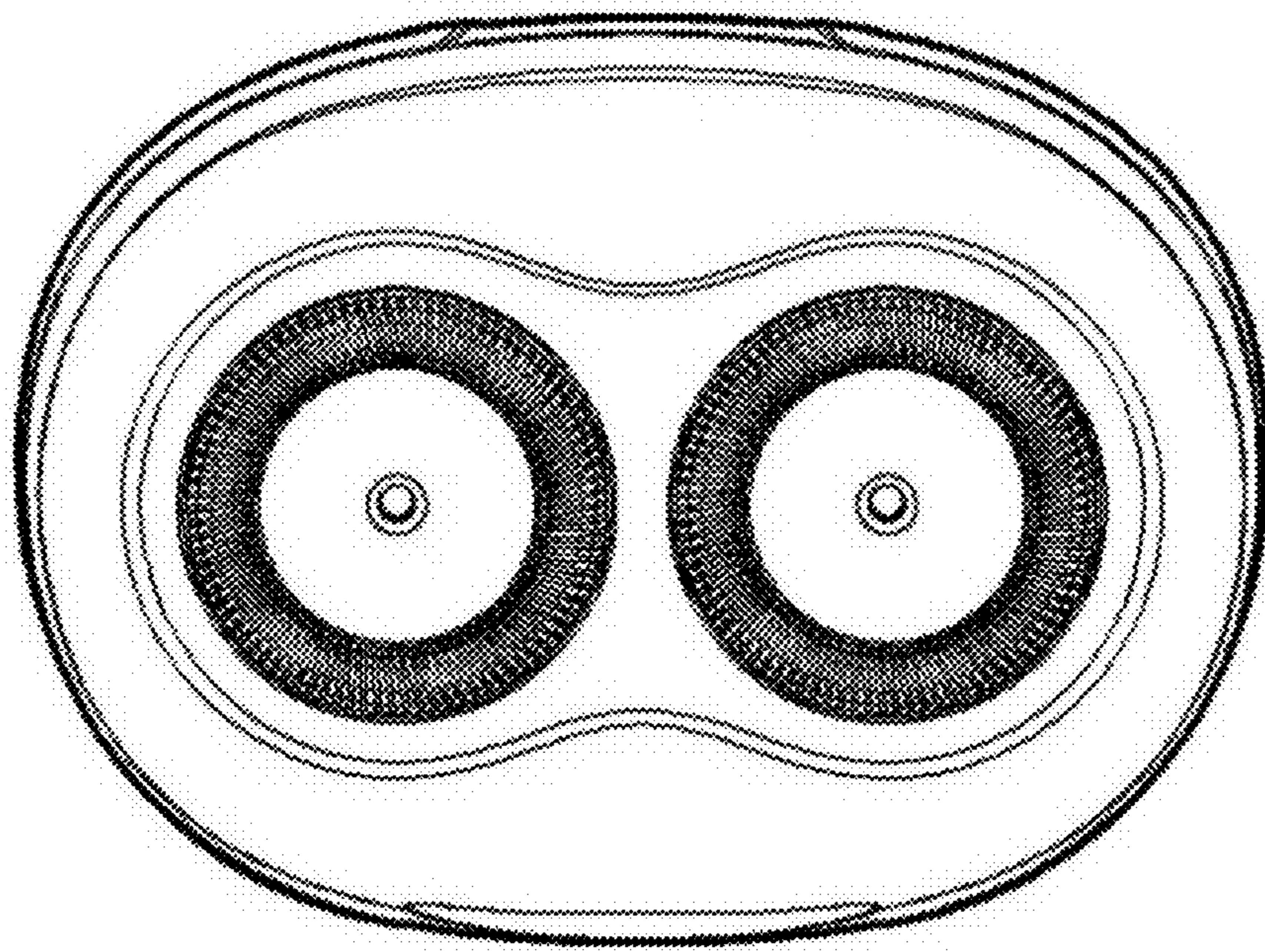

1.7

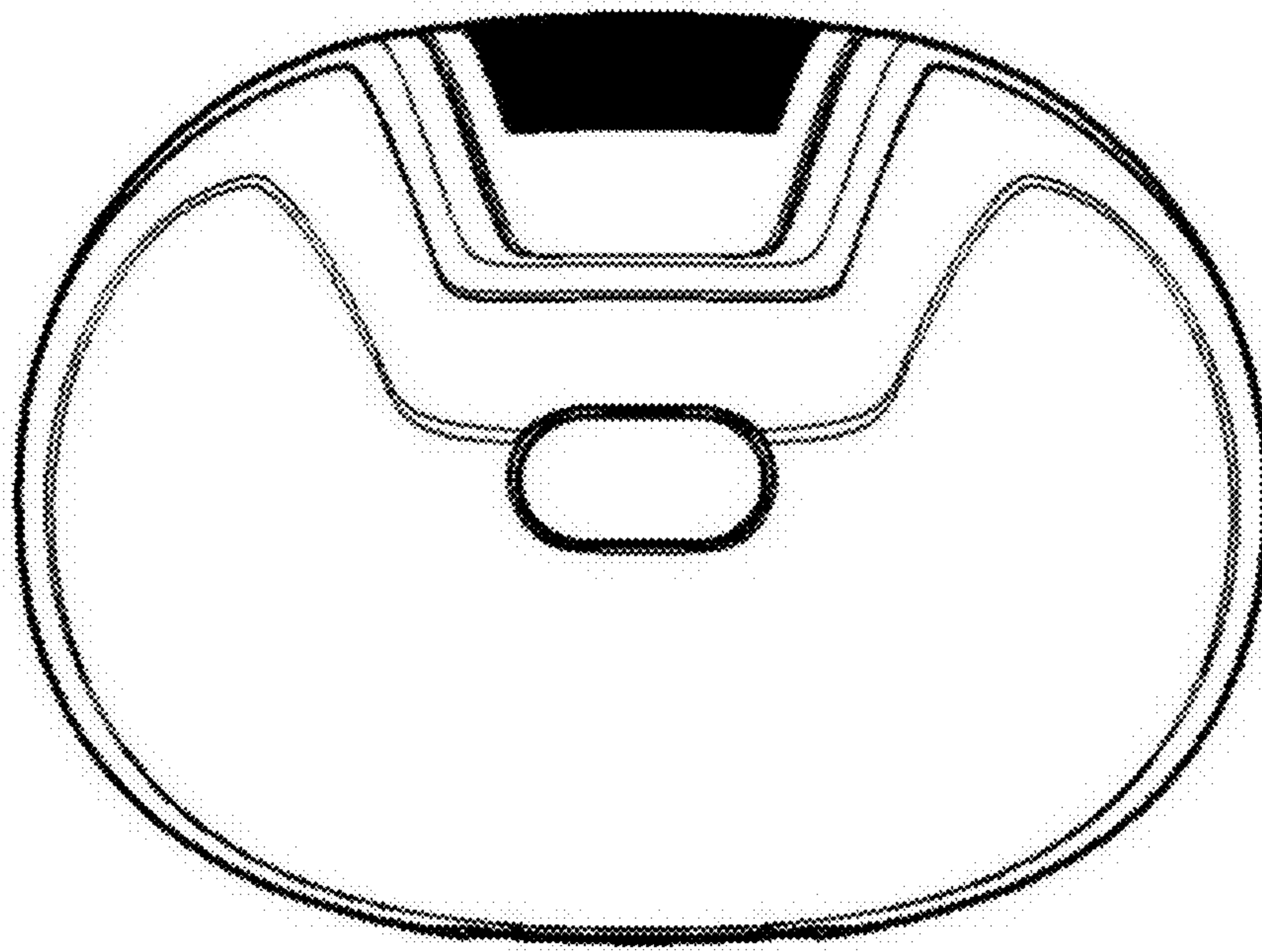

2.1

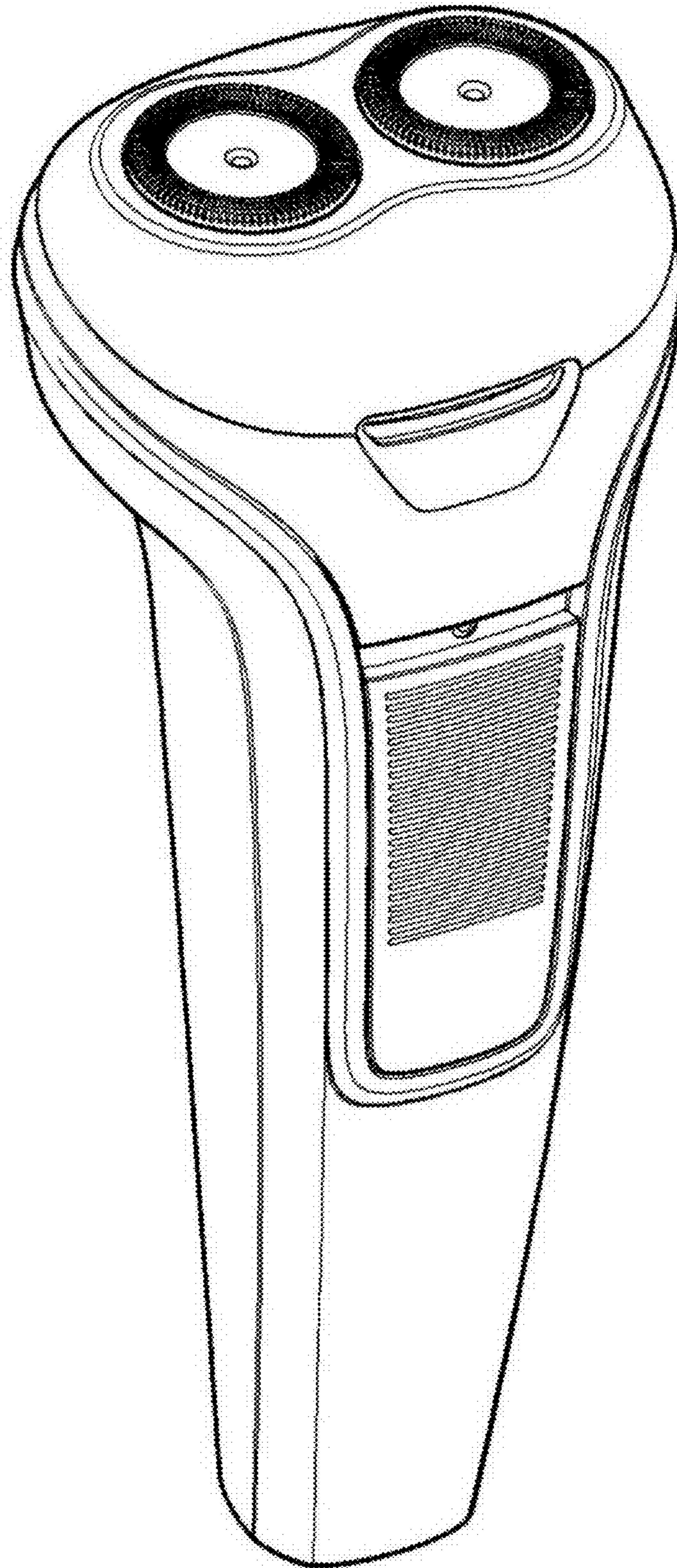

2.2

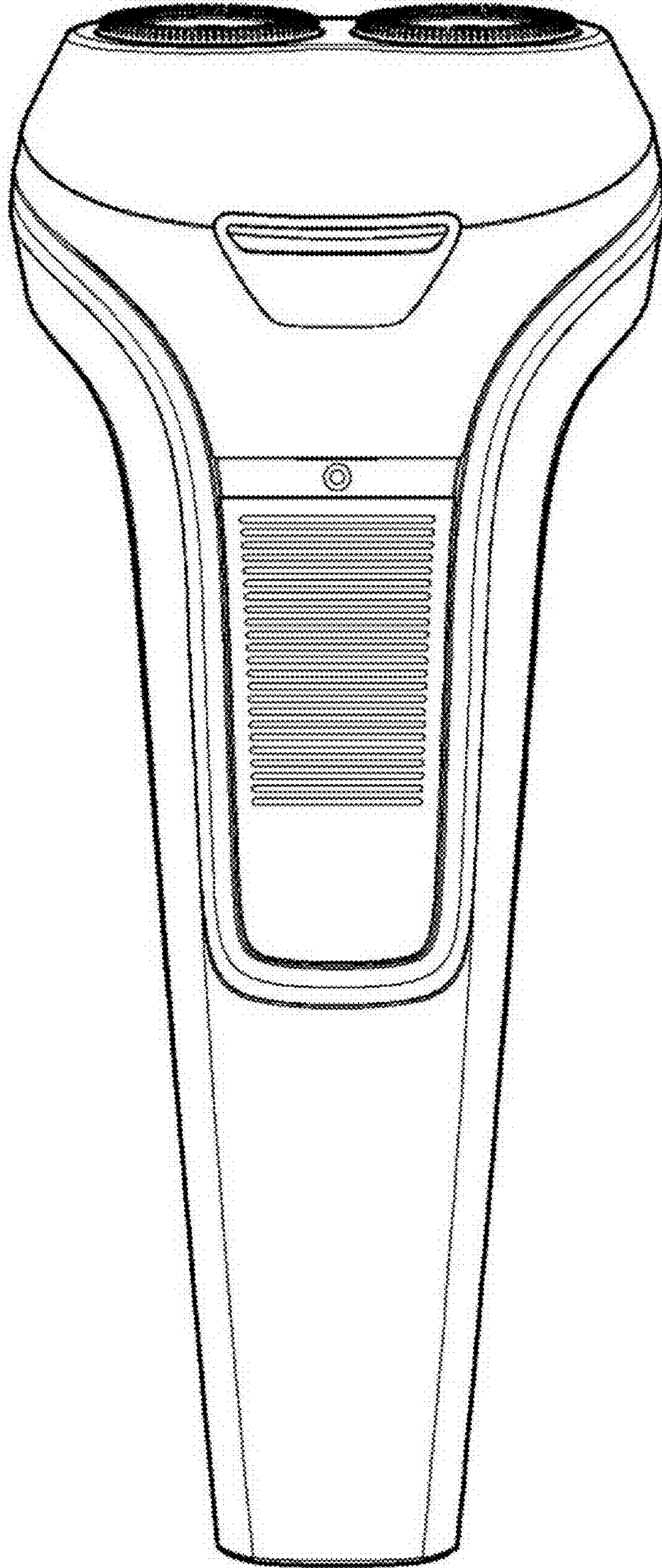

2.3

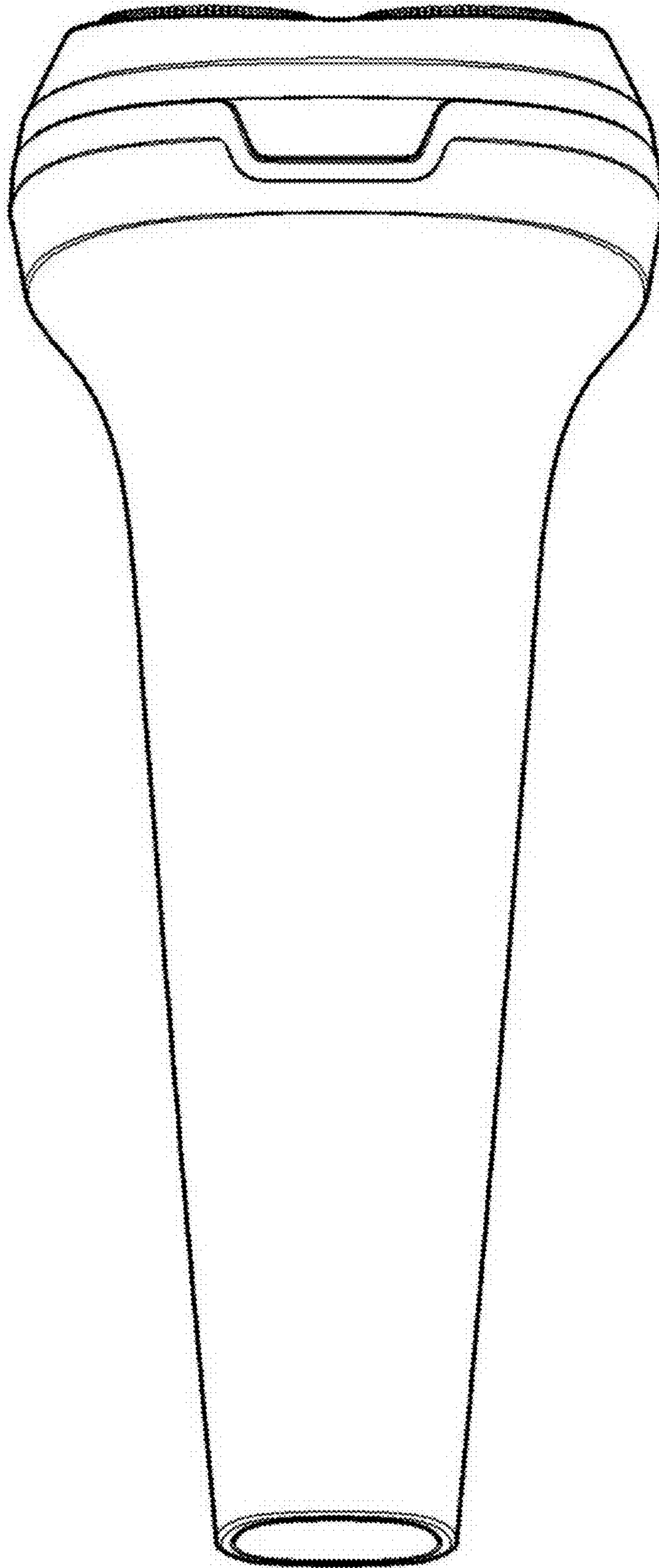

2.4

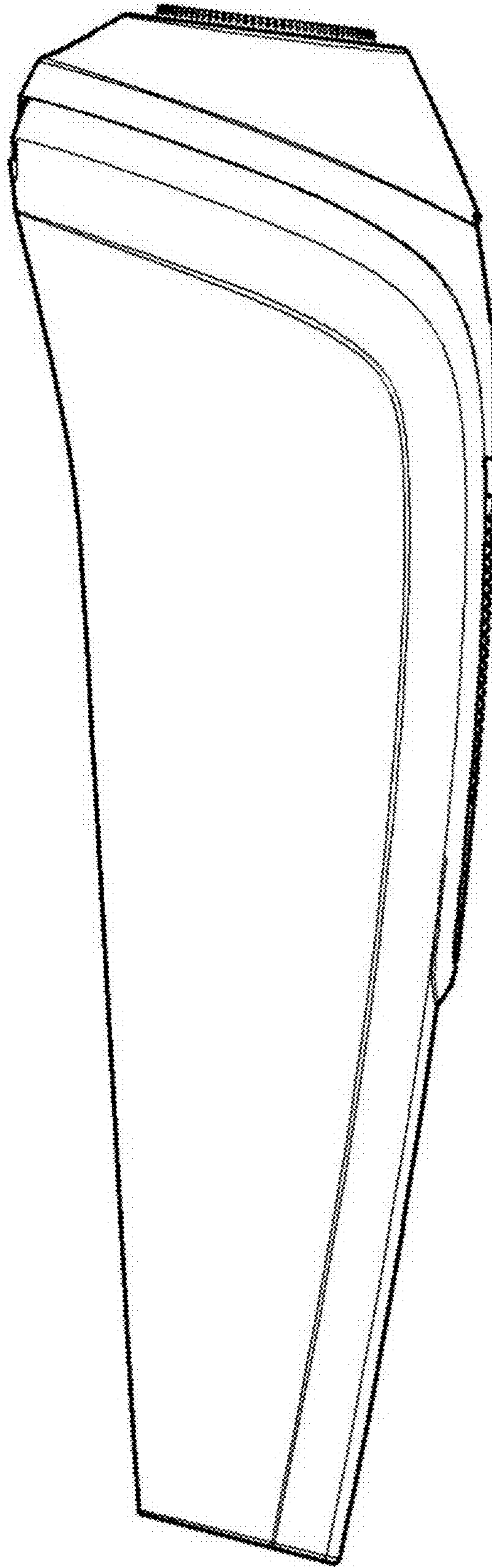

2.5

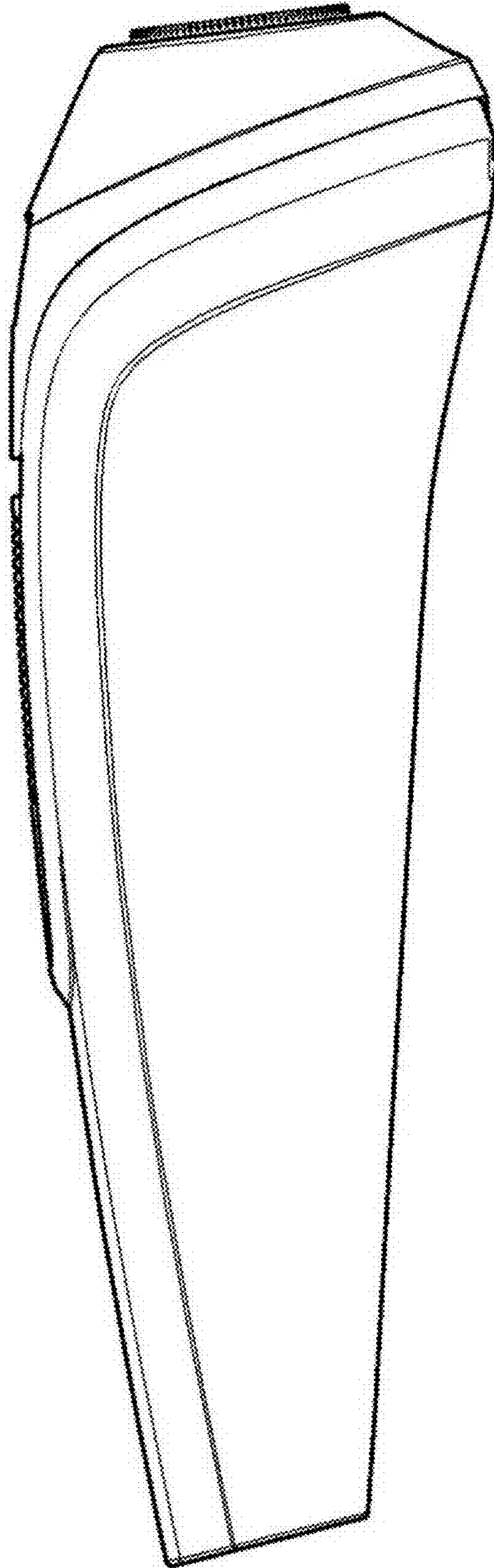

2.6

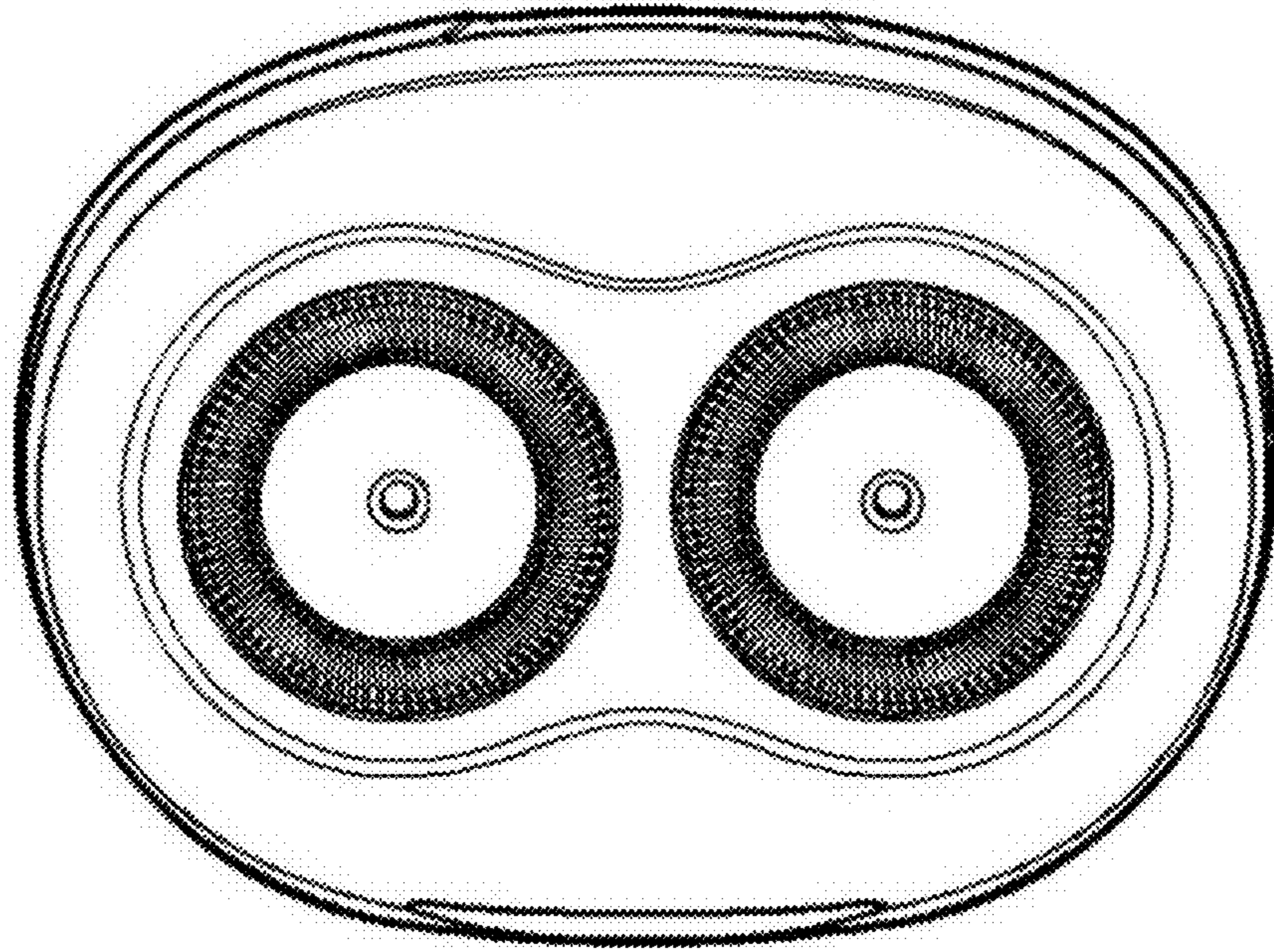

2.7

