



US00D820989S

(12) **United States Design Patent** (10) **Patent No.:** **US D820,989 S**
Wightman et al. (45) **Date of Patent:** **** Jun. 19, 2018**

(54) **BLOOD TESTING APPARATUS**

2560/0462; A61M 25/0606; A61M 25/0631

(71) Applicant: **Roche Diagnostics Operations, Inc.**,
Indianapolis, IN (US)

See application file for complete search history.

(72) Inventors: **Craig Ian Wightman**, Bristol (GB);
Johann Florian Wassermann, Horgen (CH); **Michael John Unwin**,
Bishopston Bristol (GB)

(56) **References Cited**

U.S. PATENT DOCUMENTS

(73) Assignee: **Roche Diagnostics Operations, Inc.**,
Indianapolis, IN (US)

5,281,395 A	1/1994	Markart et al.	
D406,895 S	3/1999	Byrd et al.	
D493,536 S *	7/2004	Jaeck	D24/169
D545,436 S	6/2007	Padain	
D627,068 S	11/2010	Brauer et al.	
D648,029 S	11/2011	Presta et al.	
8,427,817 B2	4/2013	Lewis et al.	
8,515,775 B2	8/2013	Galley et al.	
D690,422 S	9/2013	Oka	
D721,177 S	1/2015	Ahlstrom et al.	
D721,178 S *	1/2015	Harkin	D24/169
D723,695 S *	3/2015	Chung	D24/169
D724,223 S	3/2015	Nishiyama et al.	
9,022,931 B2	5/2015	Brauer et al.	
D734,468 S	7/2015	Murakami et al.	

(**) Term: **15 Years**

(21) Appl. No.: **29/607,658**

(22) Filed: **Jun. 15, 2017**

(Continued)

Related U.S. Application Data

Primary Examiner — Anhdao Doan

(60) Continuation of application No. 29/583,390, filed on
Nov. 4, 2016, now Pat. No. Des. 804,033, which is a
division of application No. 29/512,655, filed on Dec.
22, 2014, now Pat. No. Des. 787,067.

(74) *Attorney, Agent, or Firm* — Dinsmore & Shohl, LLP

(30) **Foreign Application Priority Data**

(57) **CLAIM**

Jun. 27, 2014 (EP) 002492397-0001
Jun. 27, 2014 (EP) 002492397-0002

The ornamental design for a blood testing apparatus, as
shown and described.

(51) **LOC (11) Cl.** **24-01**

DESCRIPTION

(52) **U.S. Cl.**
USPC **D24/169**

(58) **Field of Classification Search**
USPC D24/164–169, 186, 107, 216; D10/75,
D10/70, 98, 103
CPC A61B 5/14532; A61B 1/14865; A61B
2560/0412; A61B 2560/0443; A61B

FIG. 1 is a right side, front perspective view of a blood
testing apparatus illustrating our new design;
FIG. 2 is a left side, rear perspective view of FIG. 1 thereof;
FIG. 3 is a front view of FIG. 1 thereof;
FIG. 4 is a rear view of FIG. 1 thereof;
FIG. 5 is a bottom plan view of FIG. 1 thereof;
FIG. 6 is a top plan view of FIG. 1 thereof; and,
FIG. 7 is a left side view of FIG. 1 thereof, the right side
being the same.

(Continued)

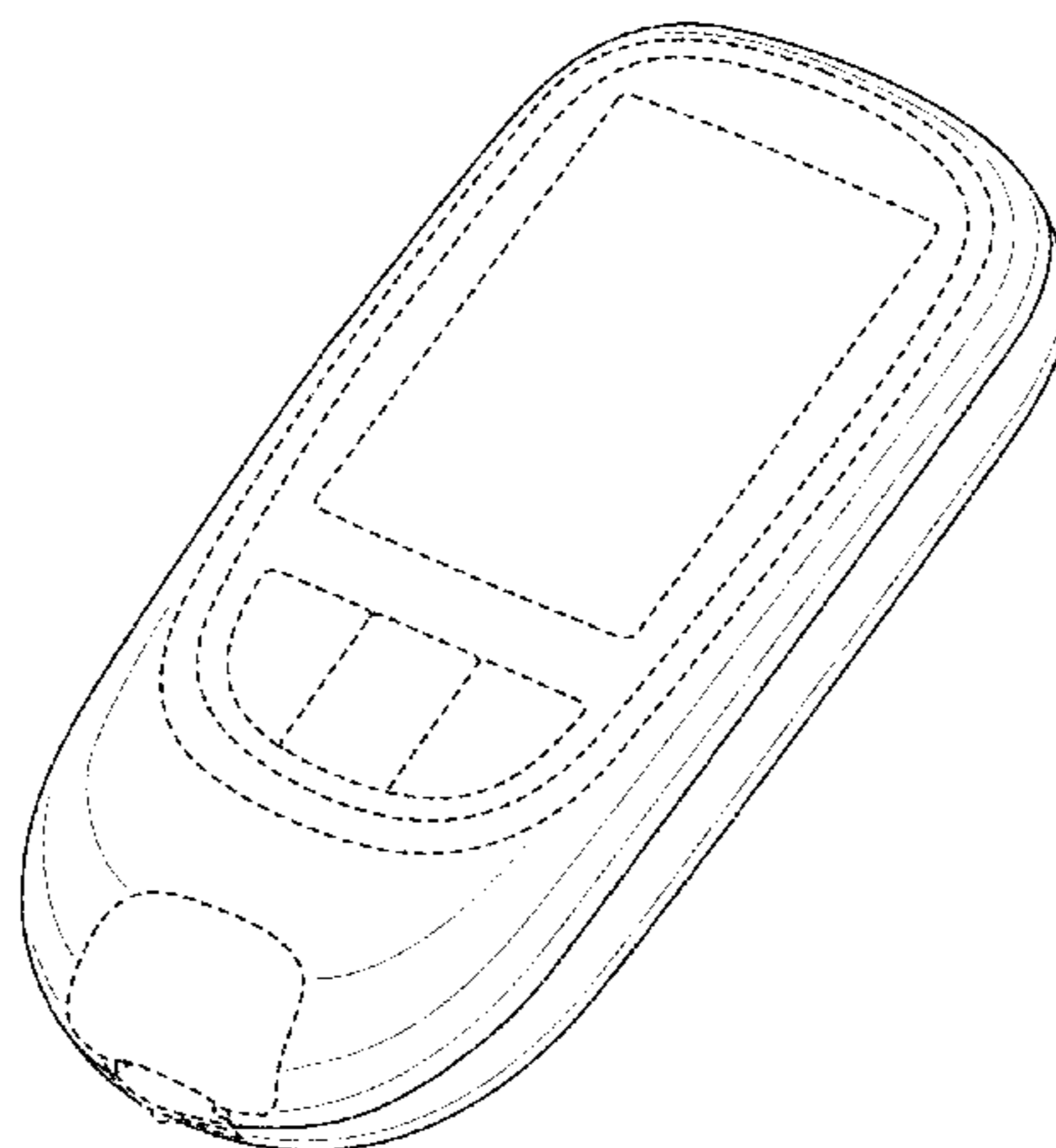

The broken lines in the drawing views illustrate portions of the blood testing apparatus that form no part of the claimed design.

1 Claim, 7 Drawing Sheets

(56) **References Cited**

U.S. PATENT DOCUMENTS

D739,945	S *	9/2015	Cadio	D24/169
D747,490	S *	1/2016	Harkin	D24/169
D766,442	S *	9/2016	Prais	D24/169
D794,803	S *	8/2017	Thom	D24/169
2012/0095316	A1	4/2012	Lewis et al.	
2012/0095318	A1	4/2012	Galley et al.	
2012/0095691	A1	4/2012	Galley et al.	
2012/0165640	A1	6/2012	Galley et al.	
2012/0266251	A1	10/2012	Birtwhistle et al.	

* cited by examiner

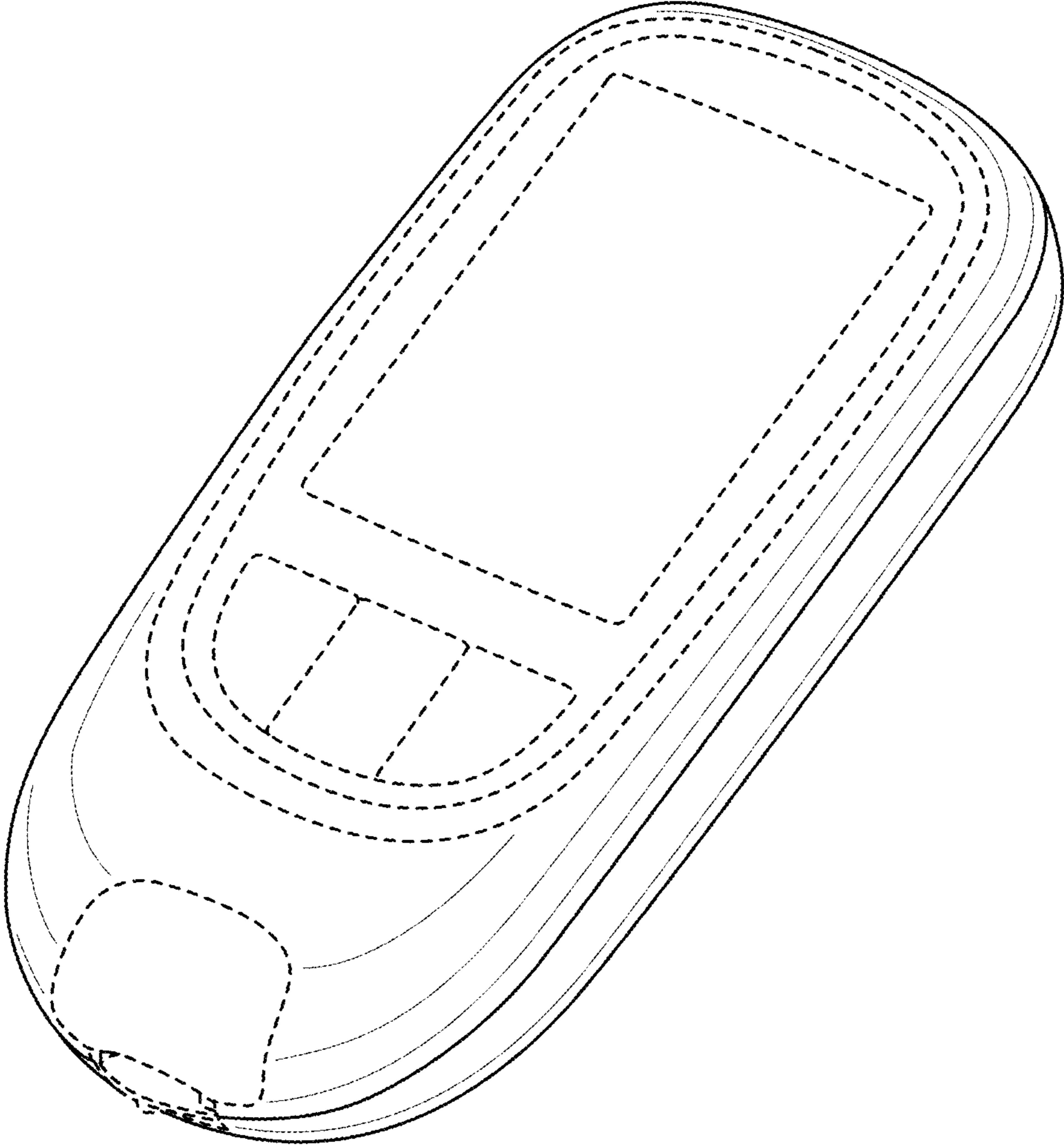

FIG. 1

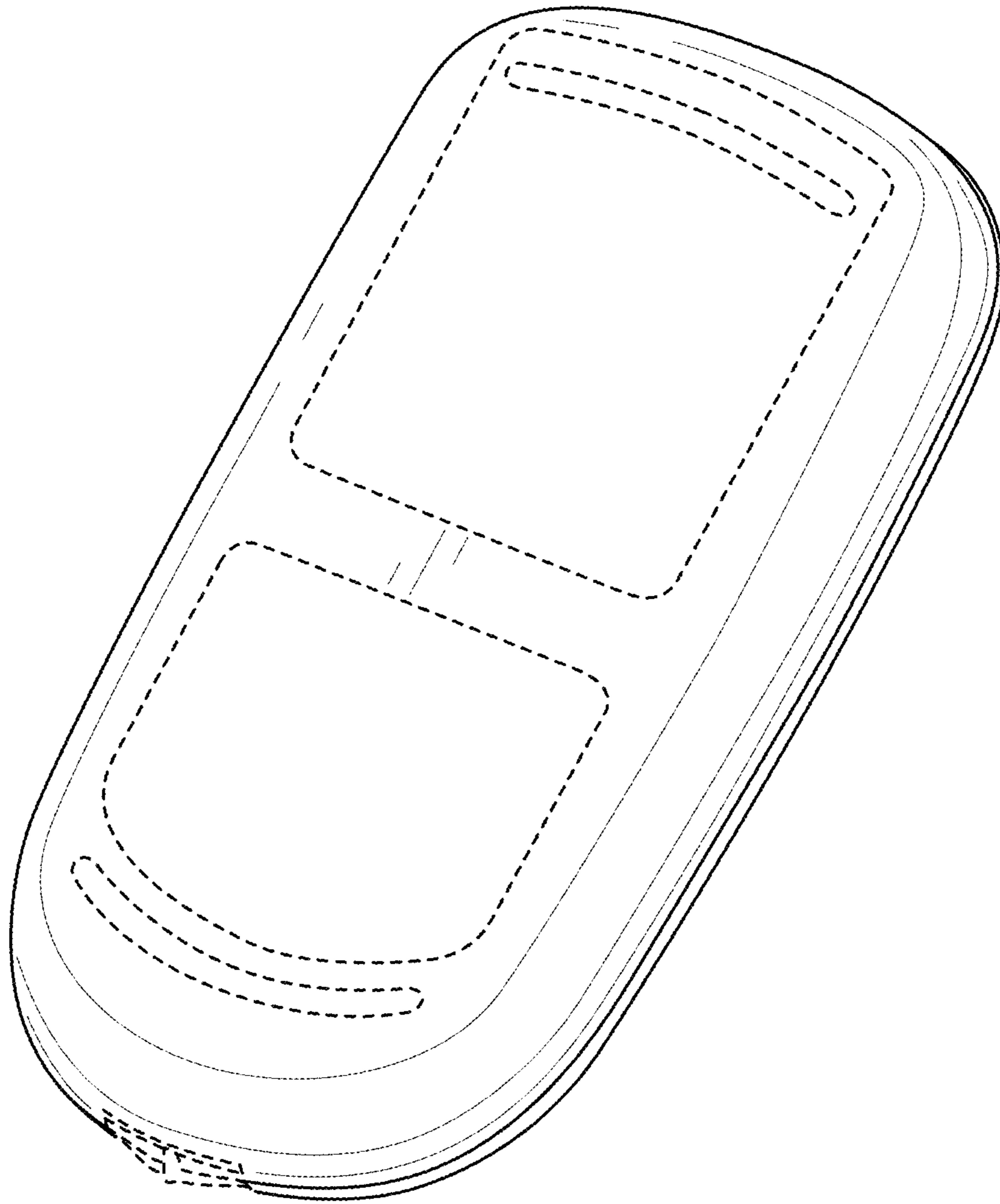

FIG. 2

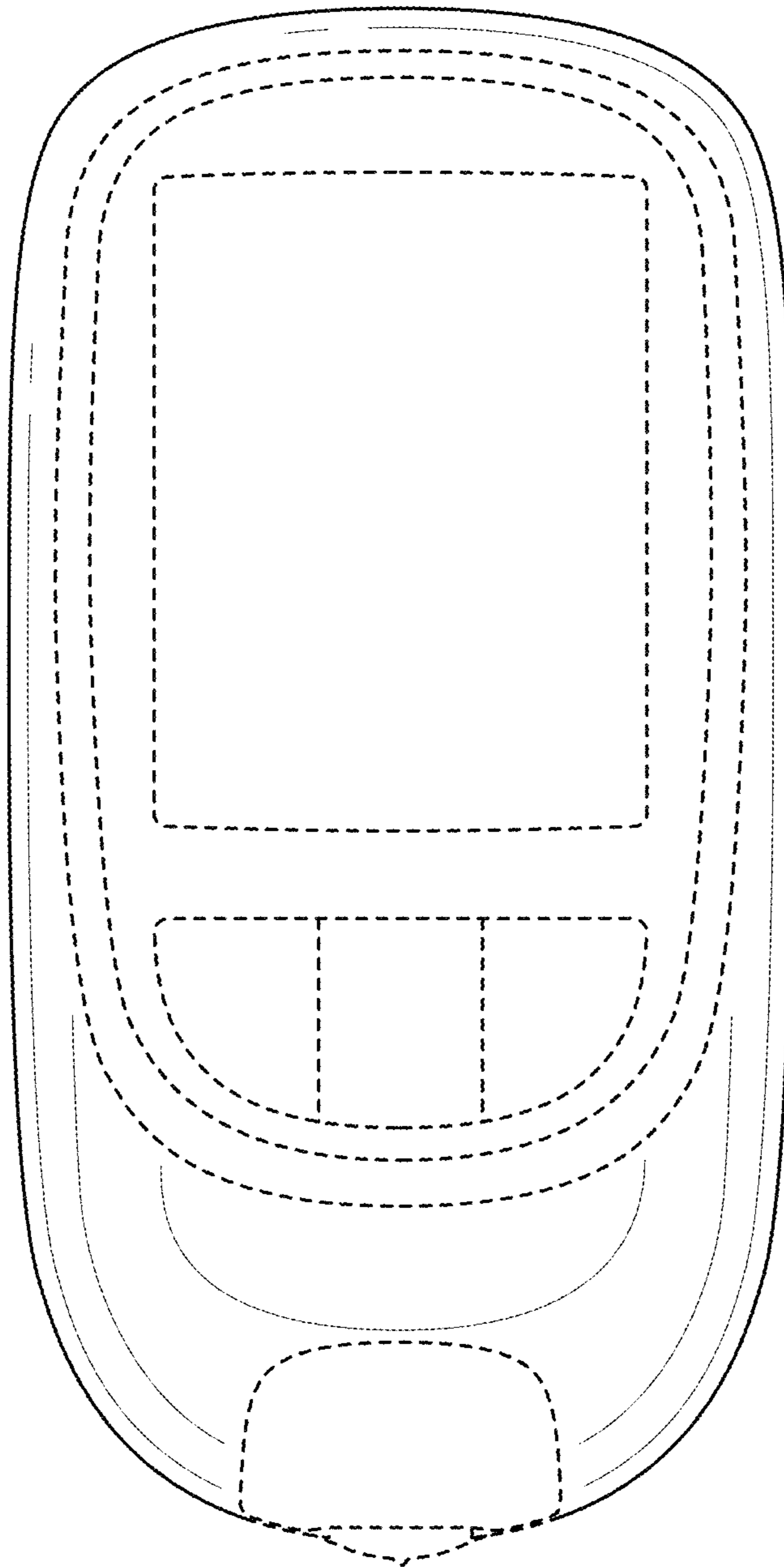

FIG. 3

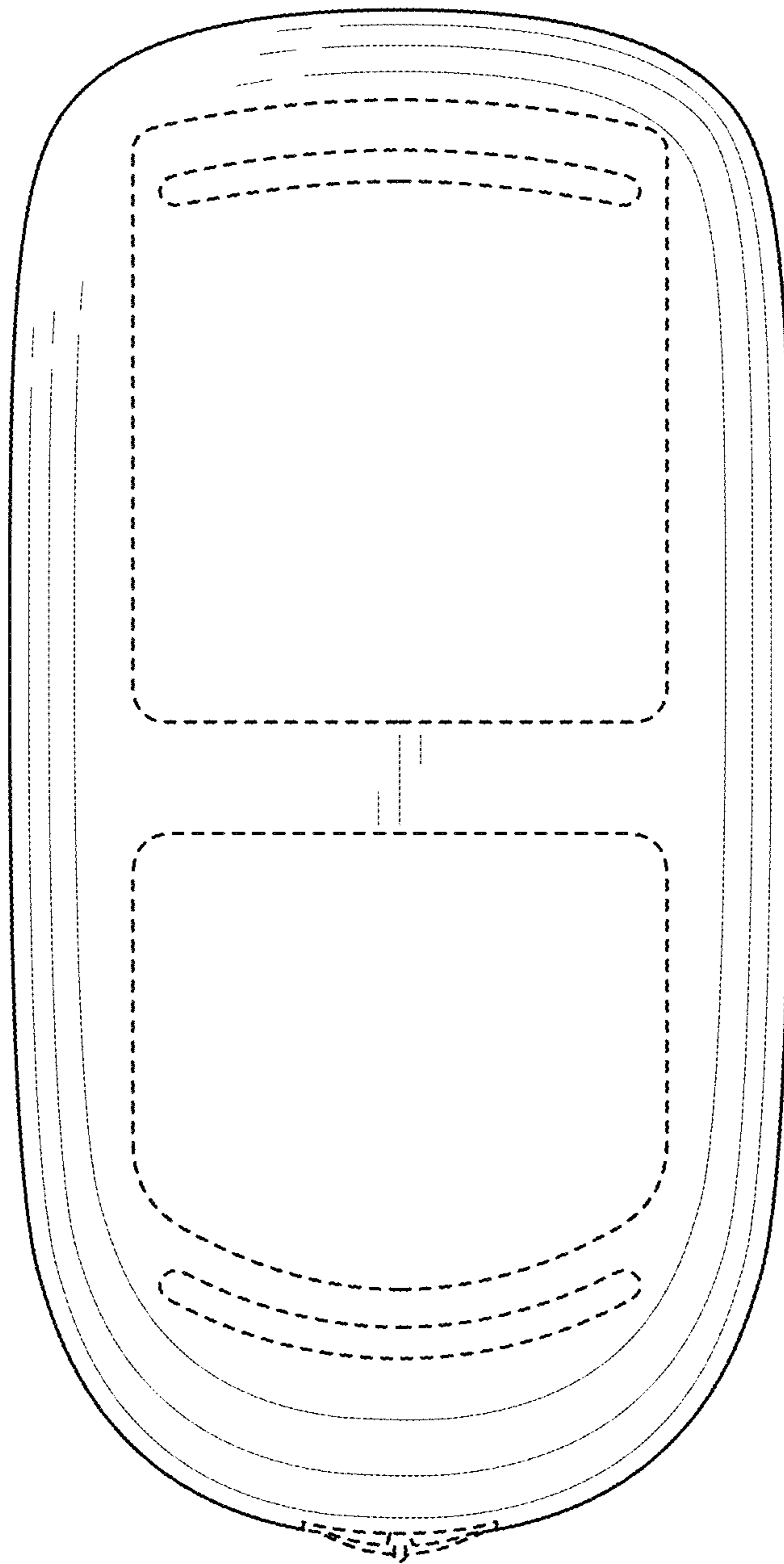

FIG. 4

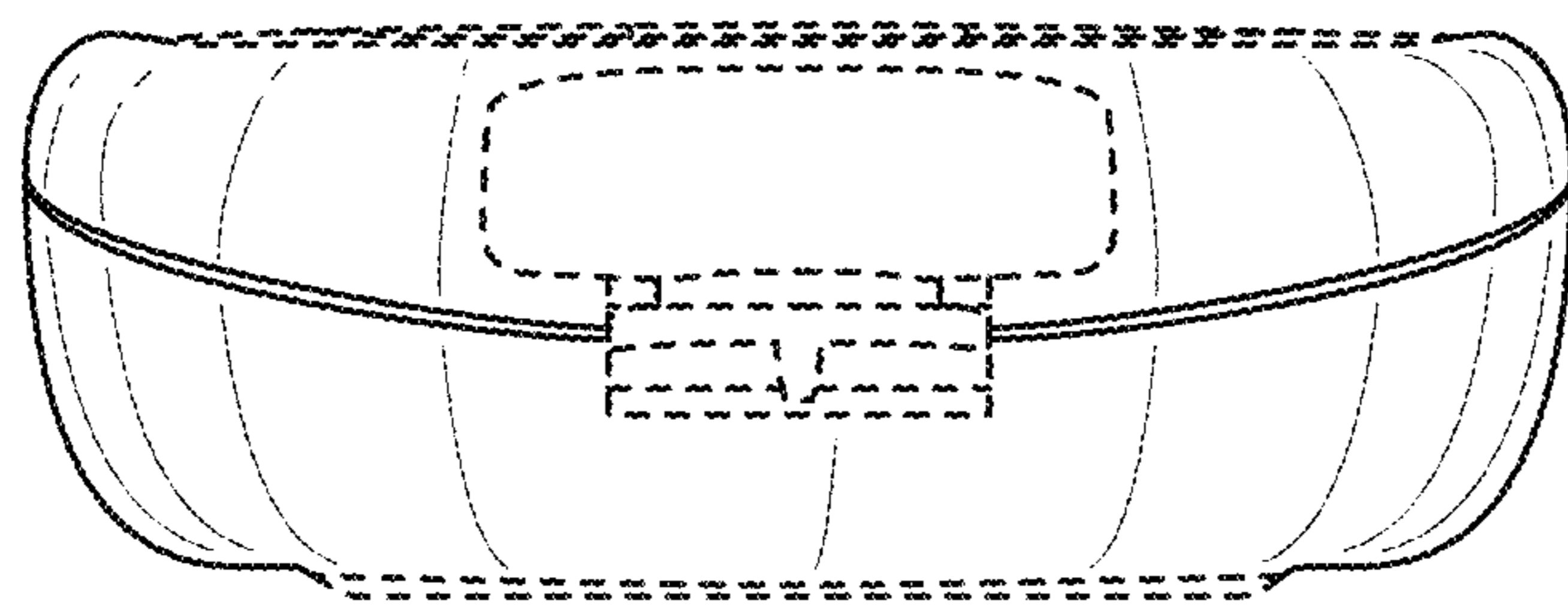

FIG. 5

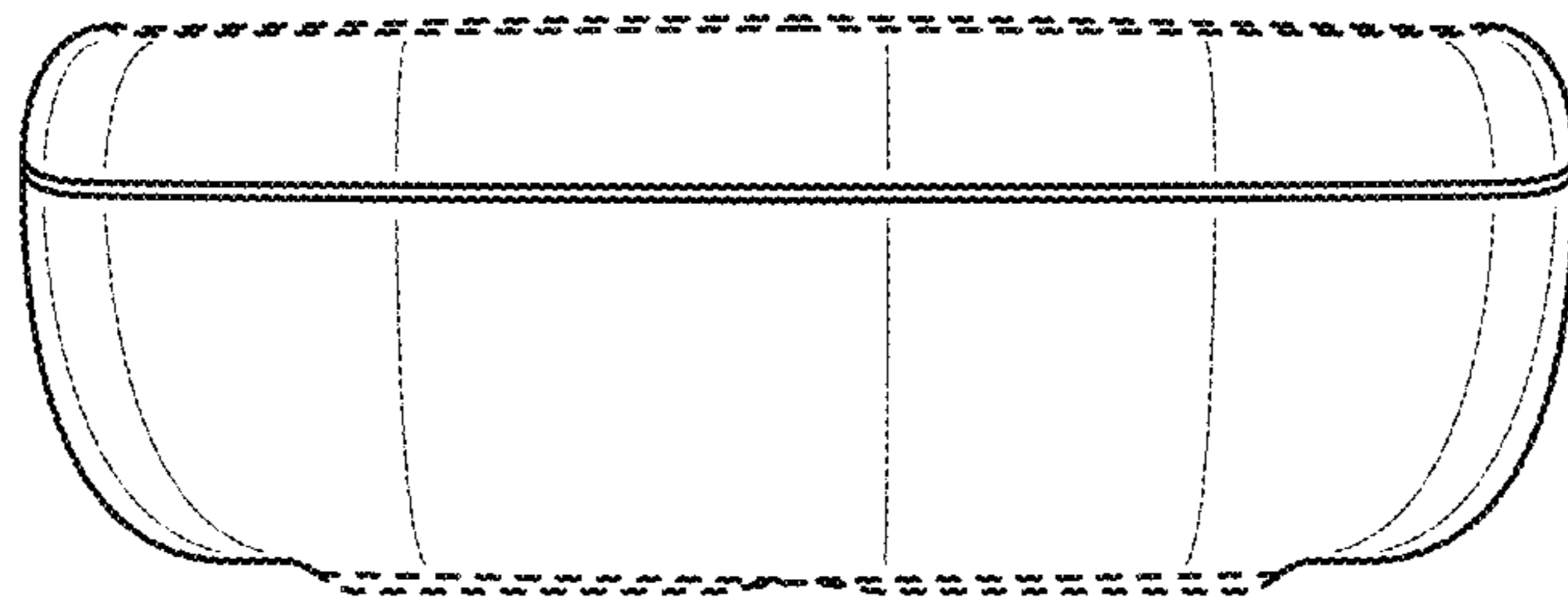

FIG. 6

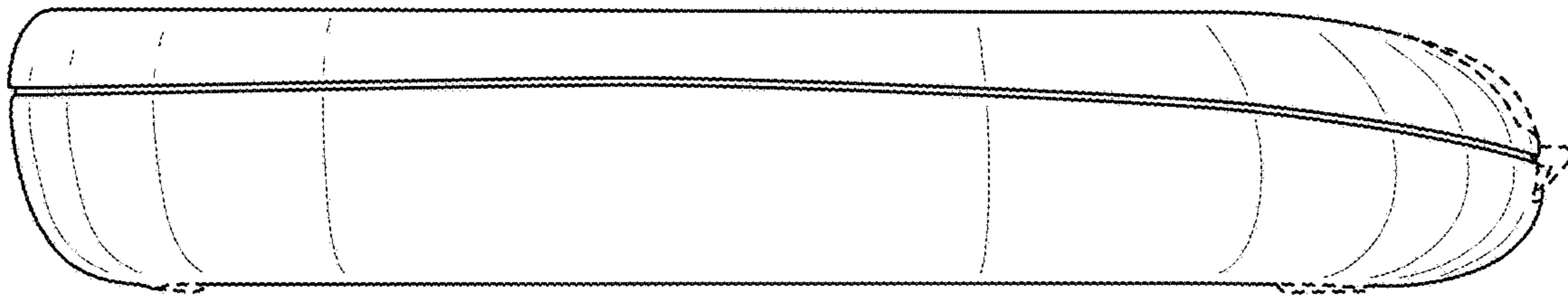

FIG. 7