



US00D820958S

(12) **United States Design Patent**
Gage

(10) **Patent No.:** **US D820,958 S**

(45) **Date of Patent:** **** Jun. 19, 2018**

(54) **FAUCET**

(71) Applicant: **DELTA FAUCET COMPANY,**
Indianapolis, IN (US)

(72) Inventor: **Logan Gage,** Milwaukee, WI (US)

(73) Assignee: **DELTA FAUCET COMPANY,**
Indianapolis, IN (US)

(**) Term: **15 Years**

(21) Appl. No.: **29/601,549**

(22) Filed: **Apr. 24, 2017**

(51) **LOC (11) Cl.** **23-01**

(52) **U.S. Cl.**
USPC **D23/238**

(58) **Field of Classification Search**
USPC D23/238-243, 249-250, 252, 254-255,
D23/257; D08/307-308
CPC Y10T 137/9464
See application file for complete search history.

(56) **References Cited**

U.S. PATENT DOCUMENTS

D525,679 S * 7/2006 Gilbert D23/238
D653,732 S * 2/2012 Romero D23/238

D665,877 S * 8/2012 Fritz D23/238
D667,933 S * 9/2012 Kwok D23/238
D805,604 S * 12/2017 Bennett D23/238
D805,610 S * 12/2017 Bennett D23/255

* cited by examiner

Primary Examiner — Robert A Delehanty

(74) *Attorney, Agent, or Firm* — Edgar A. Zarins; Nirav
D. Parikh

(57) **CLAIM**

The ornamental design for a faucet, as shown and described.

DESCRIPTION

FIG. 1 is a perspective view of a faucet showing my new design;
FIG. 2 is a rear perspective view thereof;
FIG. 3 is a top plan view thereof;
FIG. 4 is a left side view thereof;
FIG. 5 is a right side view thereof;
FIG. 6 is a bottom view thereof;
FIG. 7 is a front elevational view thereof; and,
FIG. 8 is a rear view thereof.
The broken-line disclosure in the view represents a portion of the faucet in which the claimed design is embodied, but which forms no part of the claimed design.

1 Claim, 4 Drawing Sheets

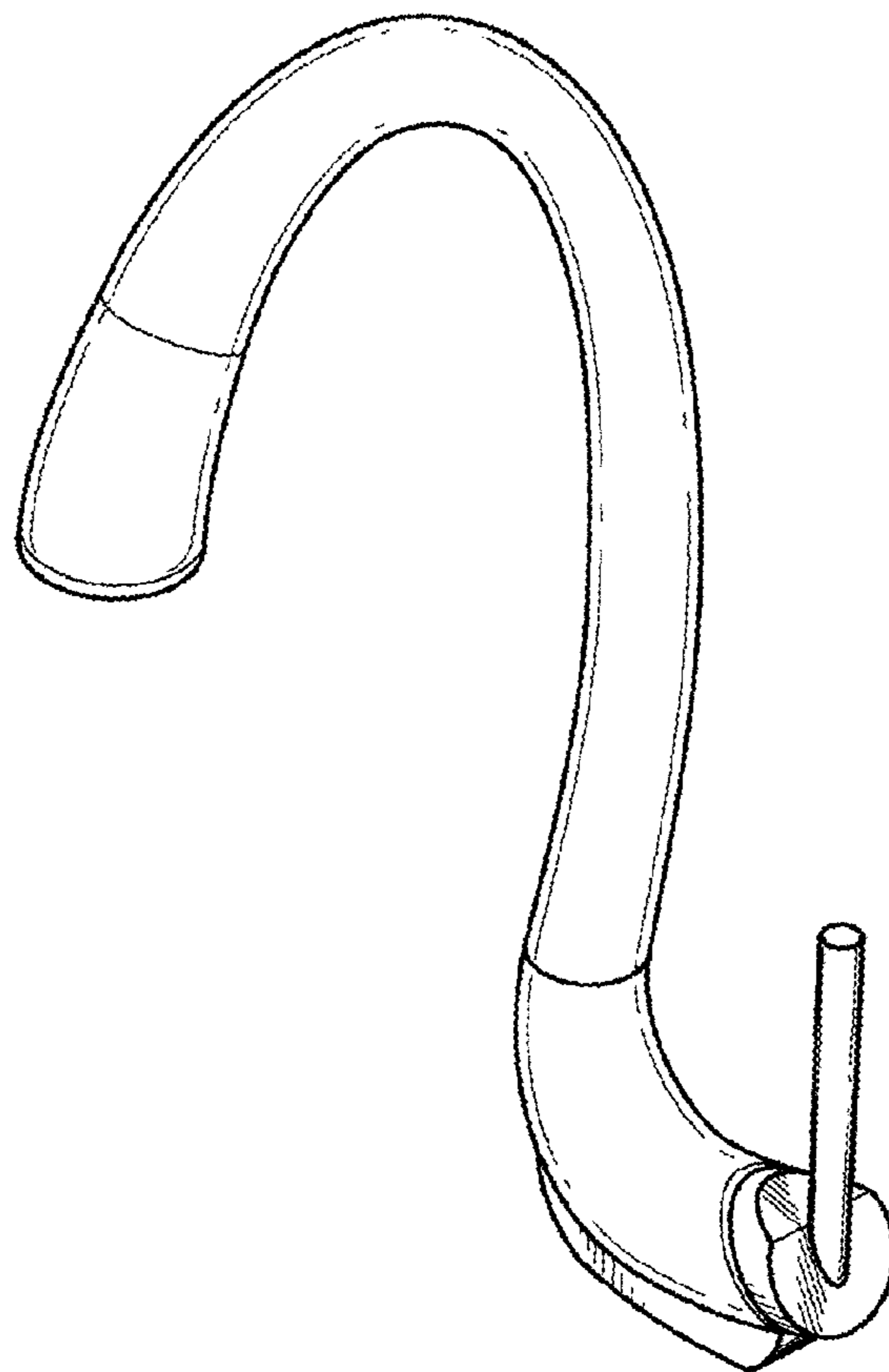

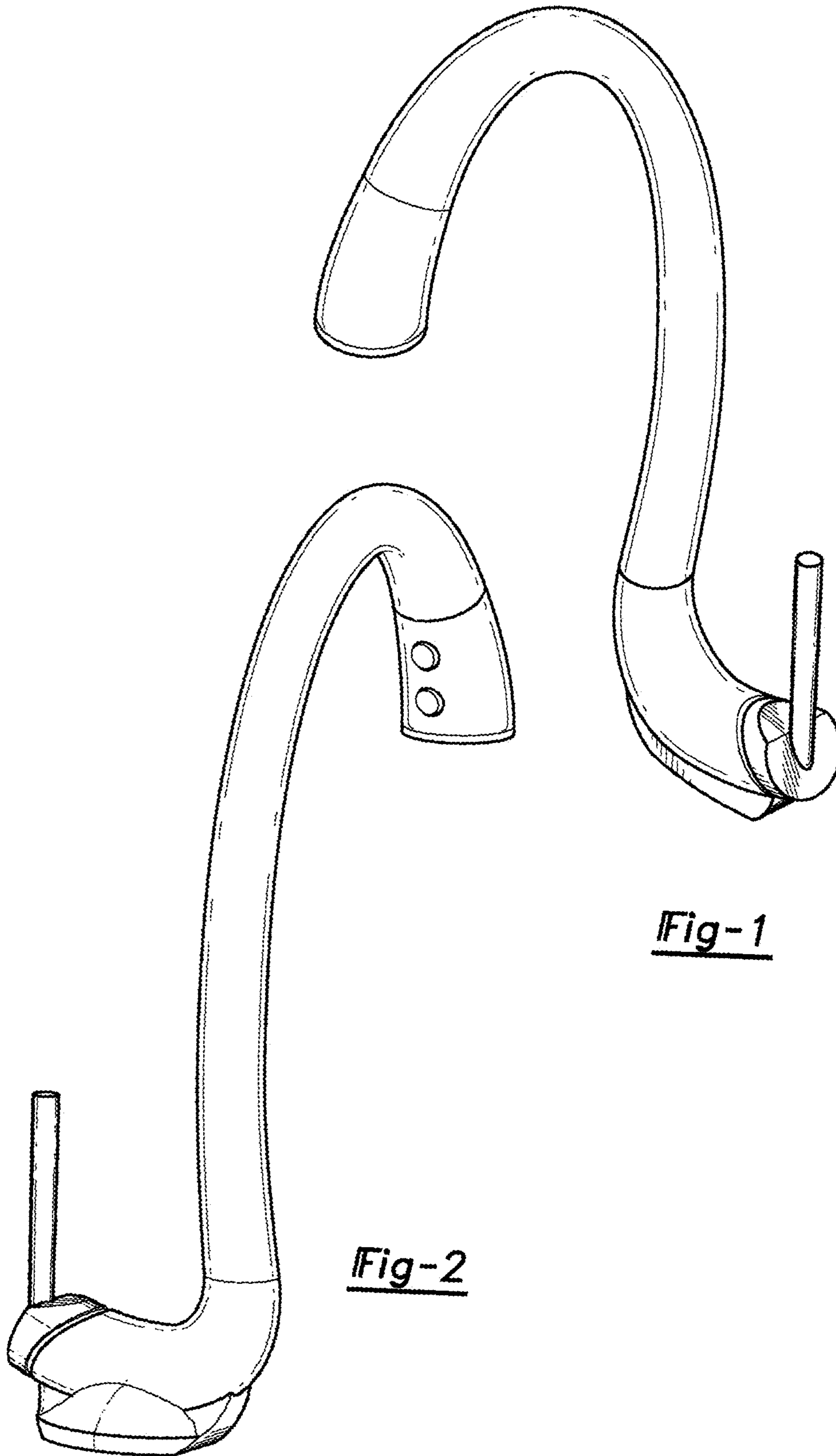

Fig-1

Fig-2

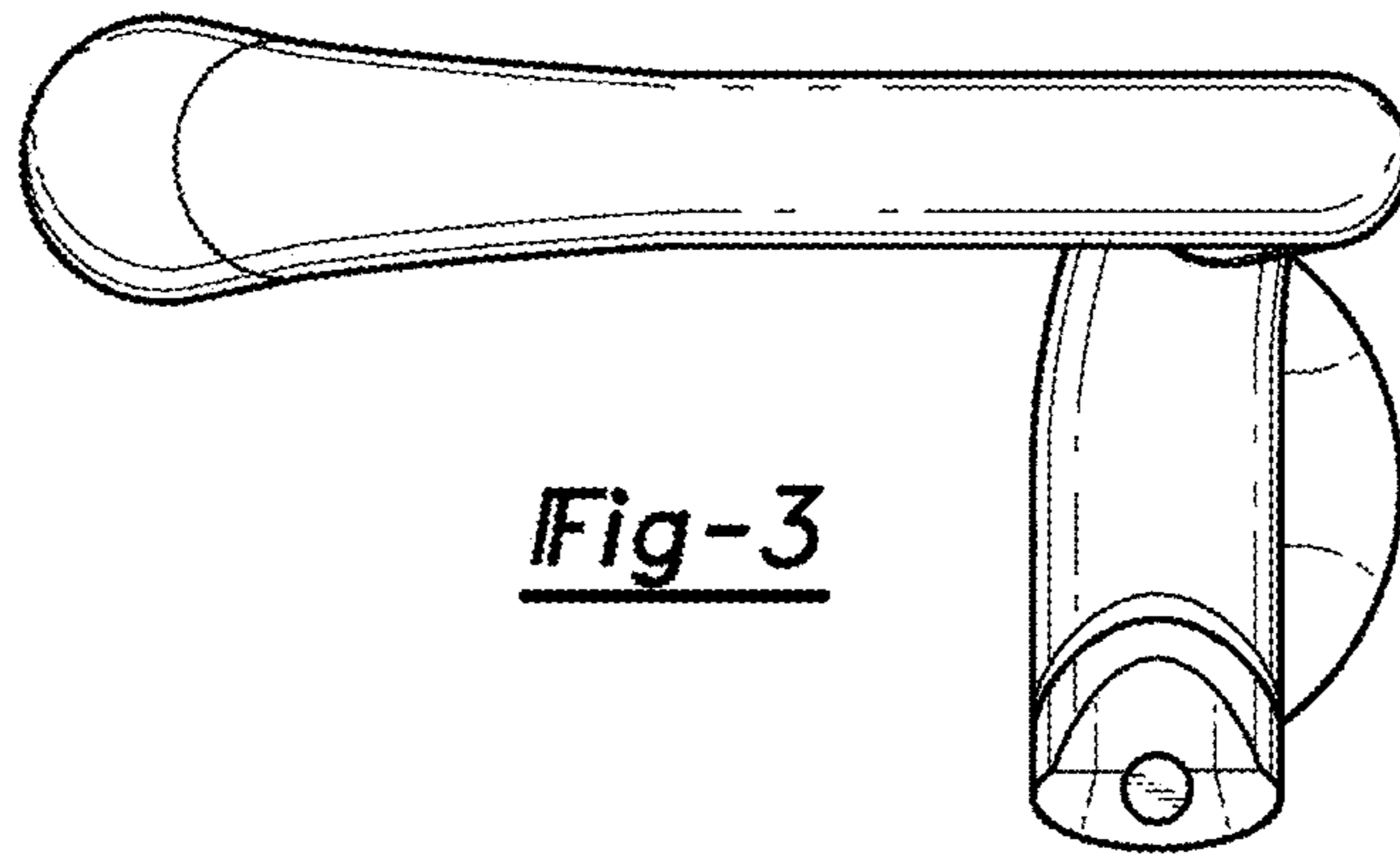

Fig-3

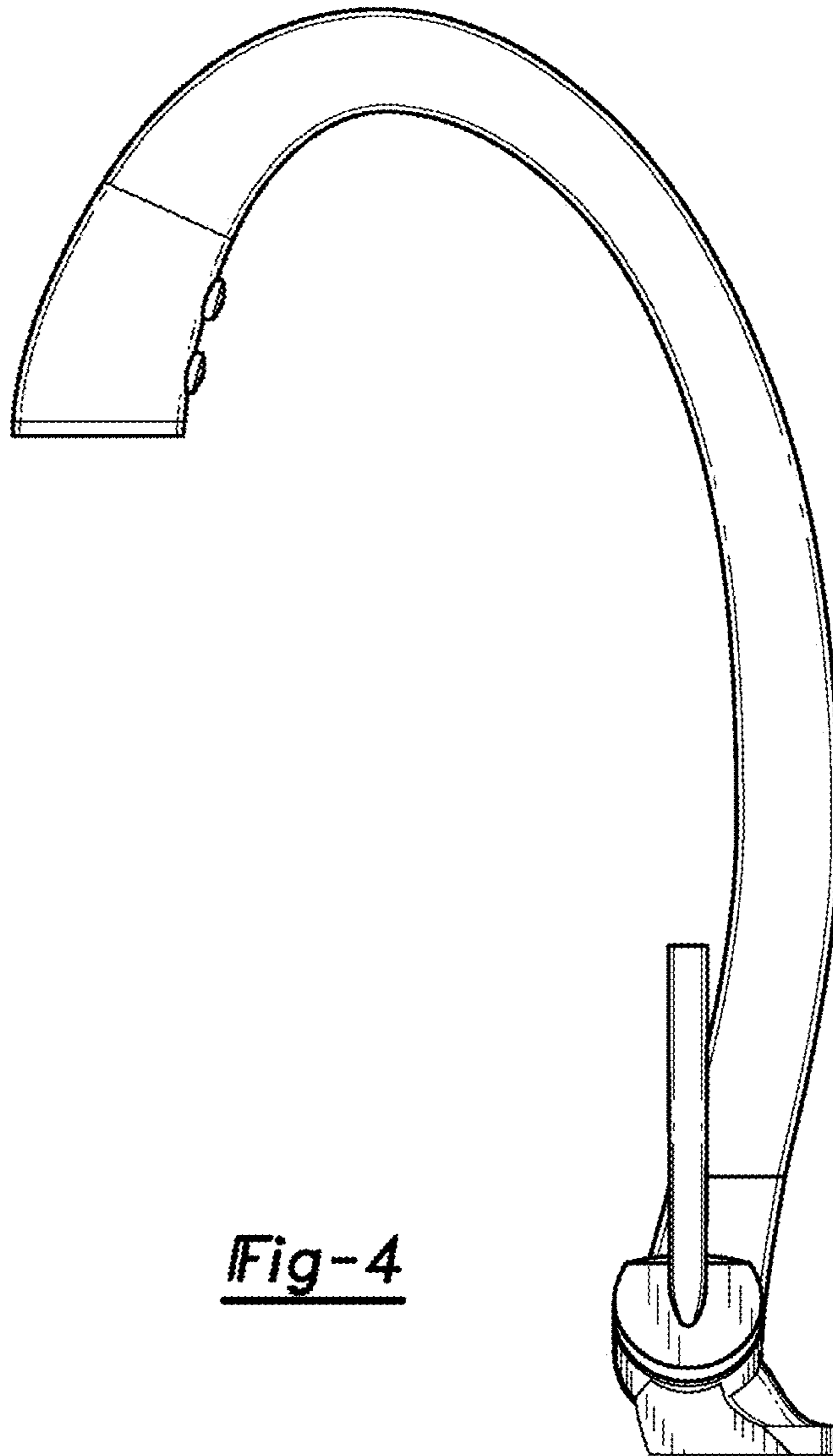

Fig-4

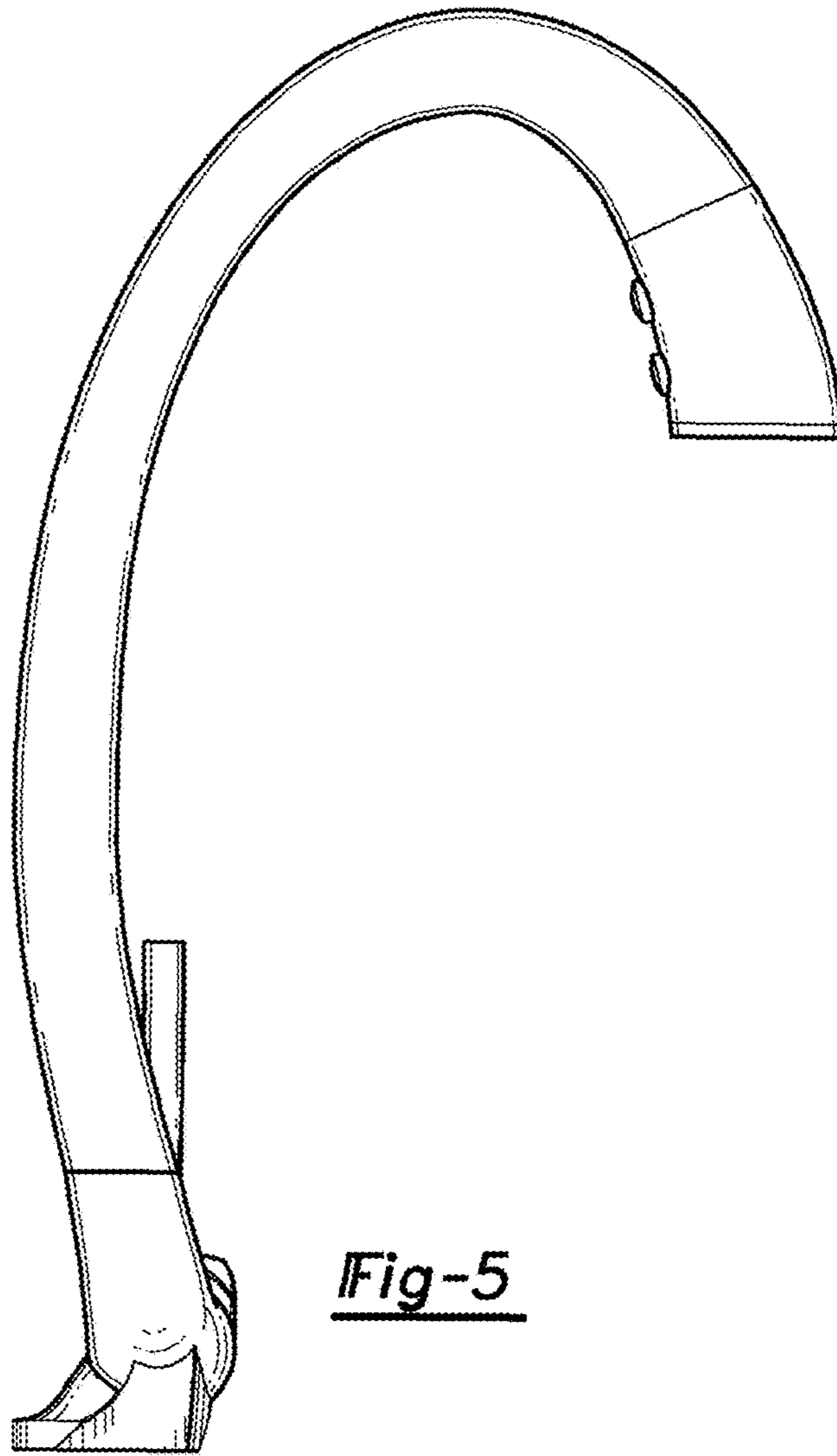

Fig-5

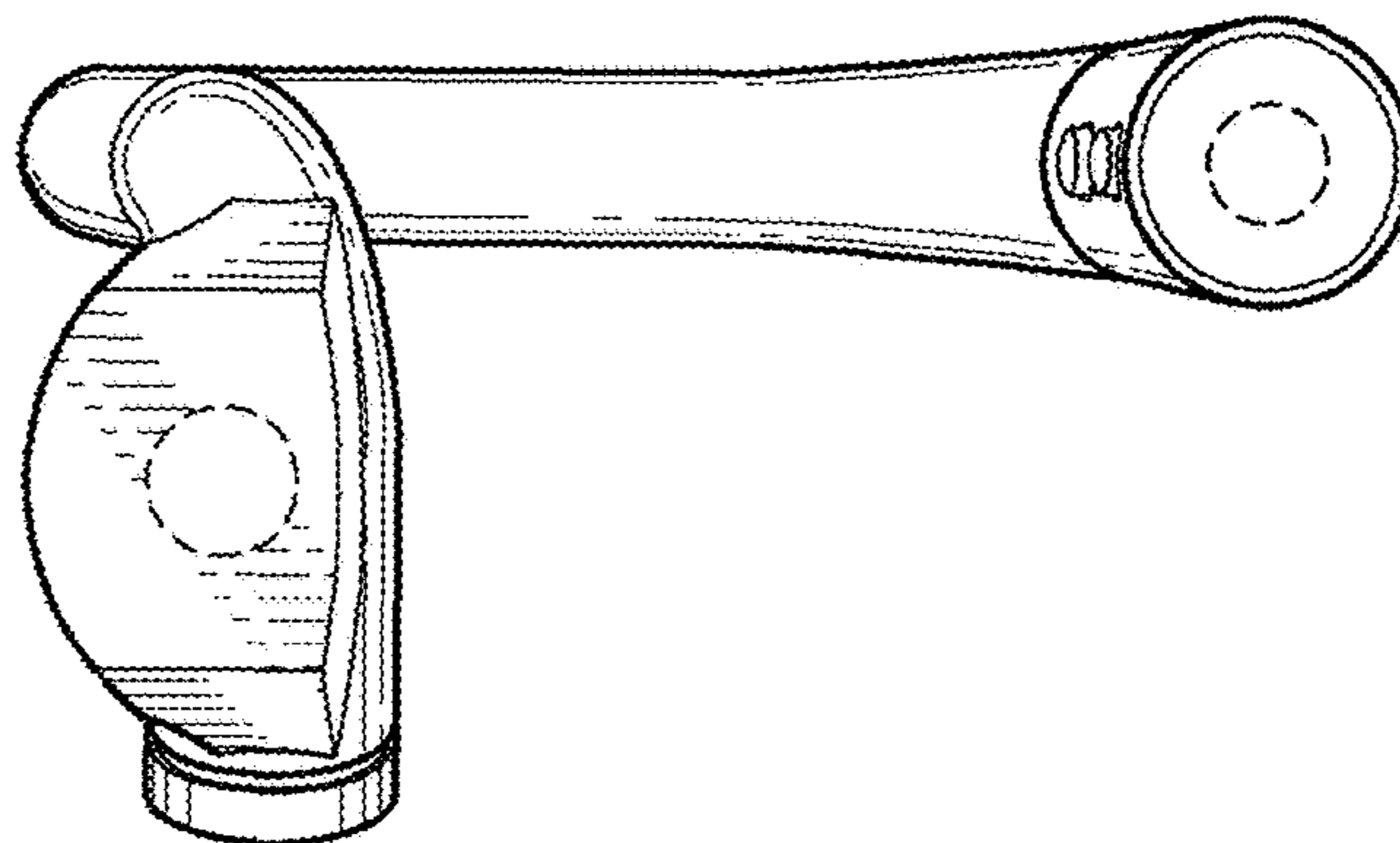

Fig-6

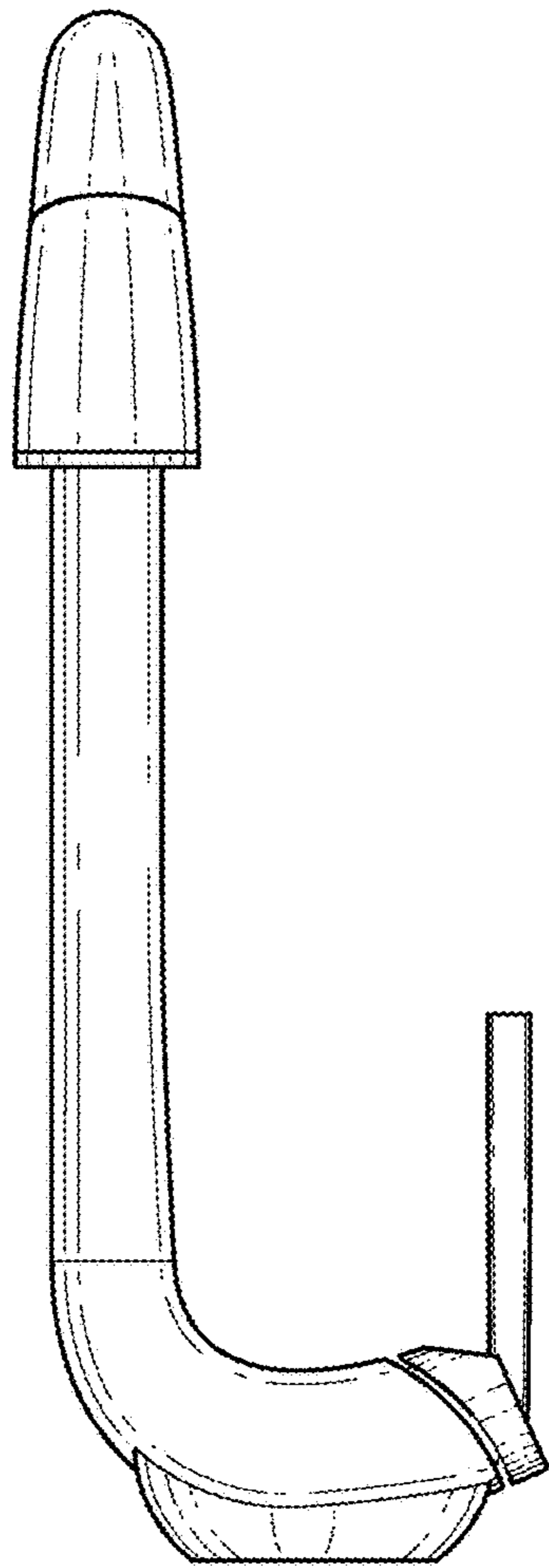

Fig-7

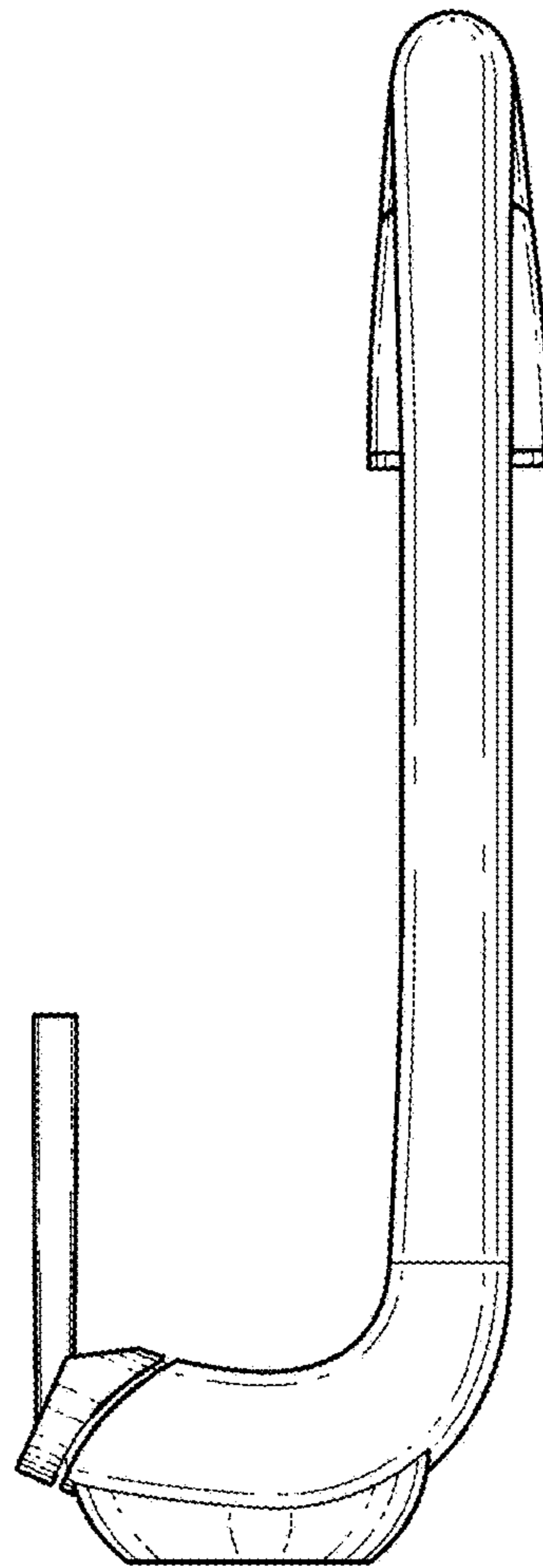

Fig-8