



US00D820692S

(12) **United States Design Patent**
Antifora

(10) **Patent No.:** **US D820,692 S**
(45) **Date of Patent:** **** Jun. 19, 2018**

(54) **WATCH**

(71) Applicant: **Montblanc-Simplo GmbH**, Hamburg
(DE)

(72) Inventor: **Valerie Antifora**, La Chaux-de-Fonds
(CH)

(73) Assignee: **Montblanc-Simplo GmbH**, Hamburg
(DE)

(**) Term: **15 Years**

(21) Appl. No.: **29/587,781**

(22) Filed: **Dec. 15, 2016**

(51) **LOC (11) Cl.** **10-02**

(52) **U.S. Cl.**
USPC **D10/39**

(58) **Field of Classification Search**
USPC D10/14, 30-39, 65, 70, 122-132;
D14/344, 138 R; 368/127
CPC ... G04F 1/00; G04F 1/06; G04F 1/063; G04F
7/06; G04F 7/0861; G04F 7/0871; G04F
7/08; G04F 7/0804; G04F 7/0842; G04F
7/0876; G04B 19/00; G04B 19/02; G04B
19/04; G04B 19/06; G04B 19/08; G04B
19/26; G04B 19/24; G04B 39/00; G04B
39/002; G04B 39/004; G04B 39/006;
A01G 25/165; B05B 12/02

See application file for complete search history.

(56) **References Cited**

U.S. PATENT DOCUMENTS

D284,356 S *	6/1986	Porsche	D10/32
D327,851 S *	7/1992	Besson	D10/32
D356,042 S *	3/1995	Nakanishi	D10/30
D398,544 S *	9/1998	Lai	D10/31
D506,685 S *	6/2005	Yamamoto	D10/32
D517,432 S *	3/2006	Laucella	D10/39
D540,195 S *	4/2007	Nussbaumer	D10/31

D564,930 S *	3/2008	Kume	D10/126
D585,768 S *	2/2009	Loth	D10/39
D609,120 S *	2/2010	Lalo	D10/39
D615,879 S *	5/2010	Monachon	D10/32
D619,486 S *	7/2010	Cerrato	D10/126
D619,916 S *	7/2010	Tedeschi	D10/126
D640,146 S *	6/2011	Tedeschi	D10/39
D650,710 S *	12/2011	Laucella	D10/39
D652,328 S *	1/2012	Laucella	D10/39
D657,704 S *	4/2012	Cerrato	D10/126
D659,554 S *	5/2012	Yurman	D10/32

(Continued)

OTHER PUBLICATIONS

Rolex Explorer II | posted at bobswatches.com No posting date given; Serial/year 2007/2008 Copyright Bob's Watches [online][site visited Sep. 25, 2017]. Available from Internet: <<https://www.bobswatches.com/rolex-explorer-ii-stainless-steel.html>>.*

(Continued)

Primary Examiner — Sandra S Snapp
Assistant Examiner — Katherine Glennon
(74) *Attorney, Agent, or Firm* — Taft Stettinius & Hollister LLP

(57) **CLAIM**

The ornamental design for a watch, as shown and described.

DESCRIPTION

FIG. 1 is a top plan view of a watch showing my new design; FIG. 2 is a bottom plan view thereof; FIG. 3 is a right side elevational view thereof; FIG. 4 is a left side elevational view thereof; FIG. 5 is a front elevational view thereof; FIG. 6 is a rear elevational view thereof; and, FIG. 7 is a right, top perspective view thereof. The broken lines in the drawing figures depict unclaimed subject matter that form no part of the claimed design.

1 Claim, 7 Drawing Sheets

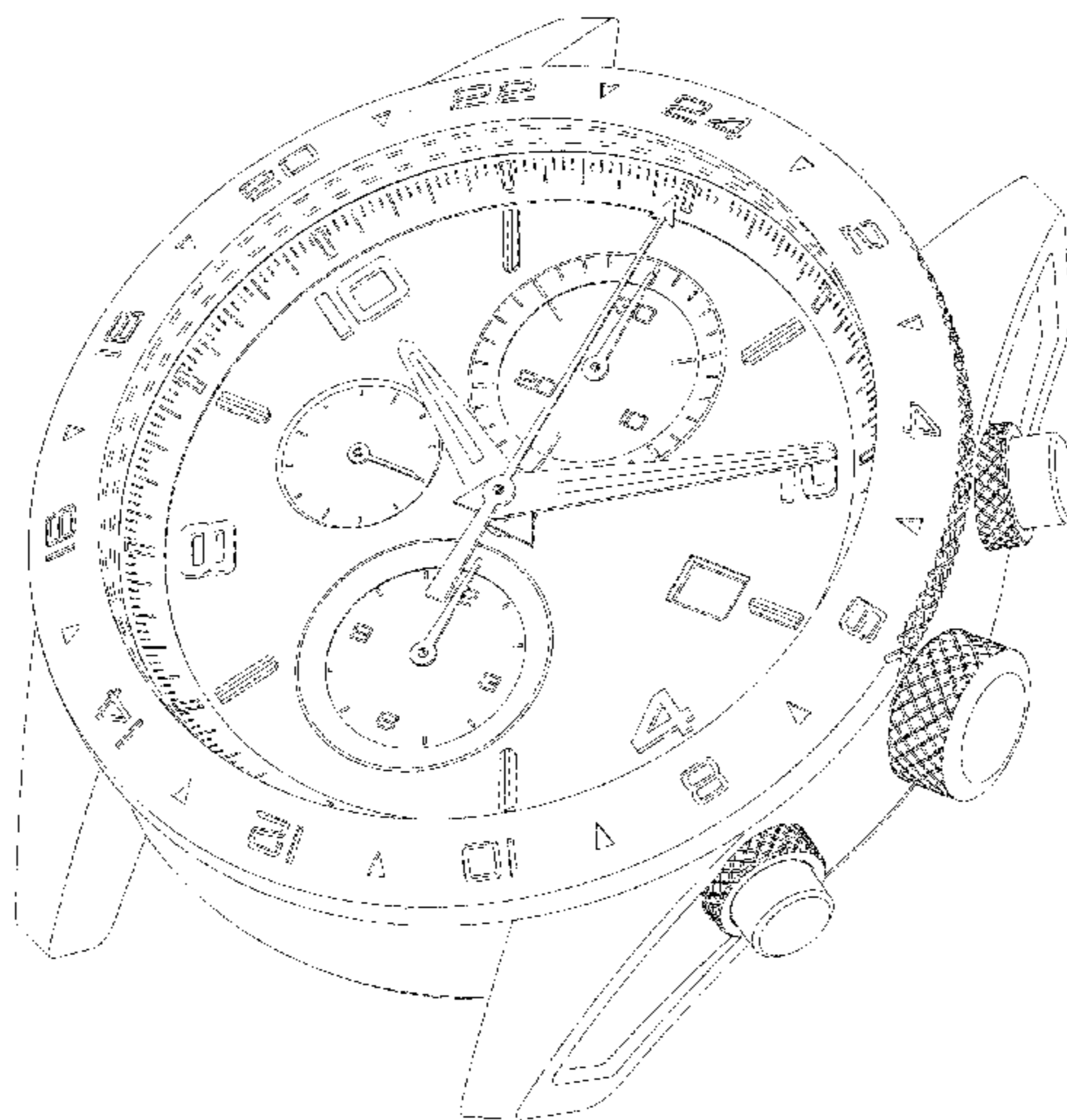

(56)

References Cited

U.S. PATENT DOCUMENTS

D684,486 S * 6/2013 Messmer D10/39
D702,136 S * 4/2014 Monachon D10/39
D712,754 S * 9/2014 Loth D10/32
D715,163 S * 10/2014 Jamin D10/126
D725,501 S * 3/2015 Jamin D10/124
D729,638 S * 5/2015 Favre D10/38
D730,201 S * 5/2015 Giannini D10/39
D736,654 S * 8/2015 Monachon D10/126
D759,510 S * 6/2016 Belamich D10/126
9,411,320 B1 * 8/2016 Liang G04R 20/26
D772,728 S * 11/2016 Nicotra D10/32
D773,333 S * 12/2016 Monachon D10/126
D787,954 S * 5/2017 Morimoto D10/30
D793,882 S * 8/2017 Kuroda D10/30
D795,116 S * 8/2017 Kamilindi D10/123
D795,117 S * 8/2017 Monachon D10/126
D796,982 S * 9/2017 Muller D10/126
2004/0052162 A1 * 3/2004 Takahashi G04F 7/08
368/101
2012/0182838 A1 * 7/2012 Farron G04B 27/026
368/18

OTHER PUBLICATIONS

Tudor Heritage Chronograph Blue 2013 | posted at watchinghorology.blogspot.com Sep. 15, 2013 [online][site visited Sep. 25, 2017]. Available from Internet: <<http://watchinghorology.blogspot.com/2013/09/tudor-heritage-chronograph-blue-most.html>>.*

* cited by examiner

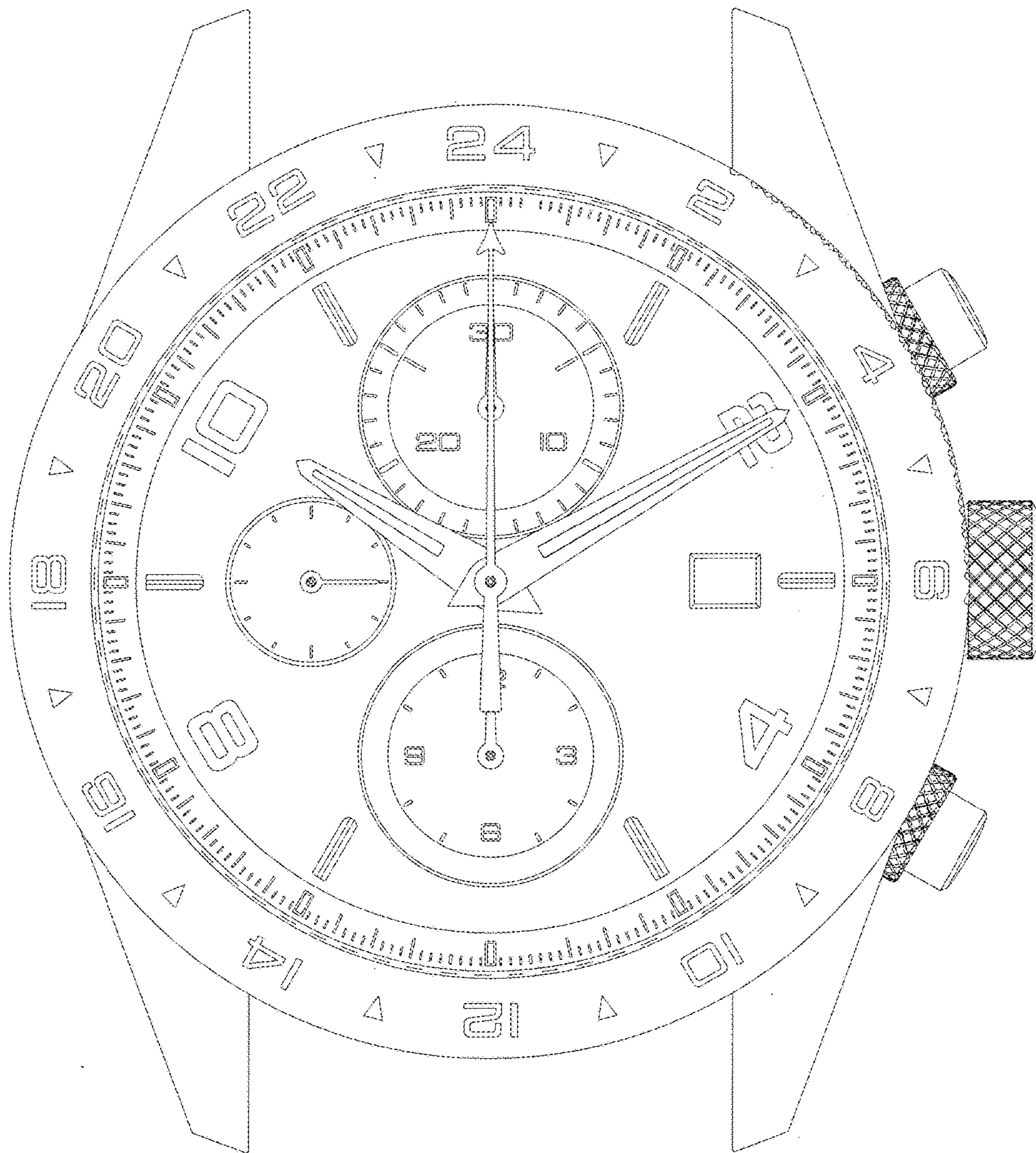

Fig. 1

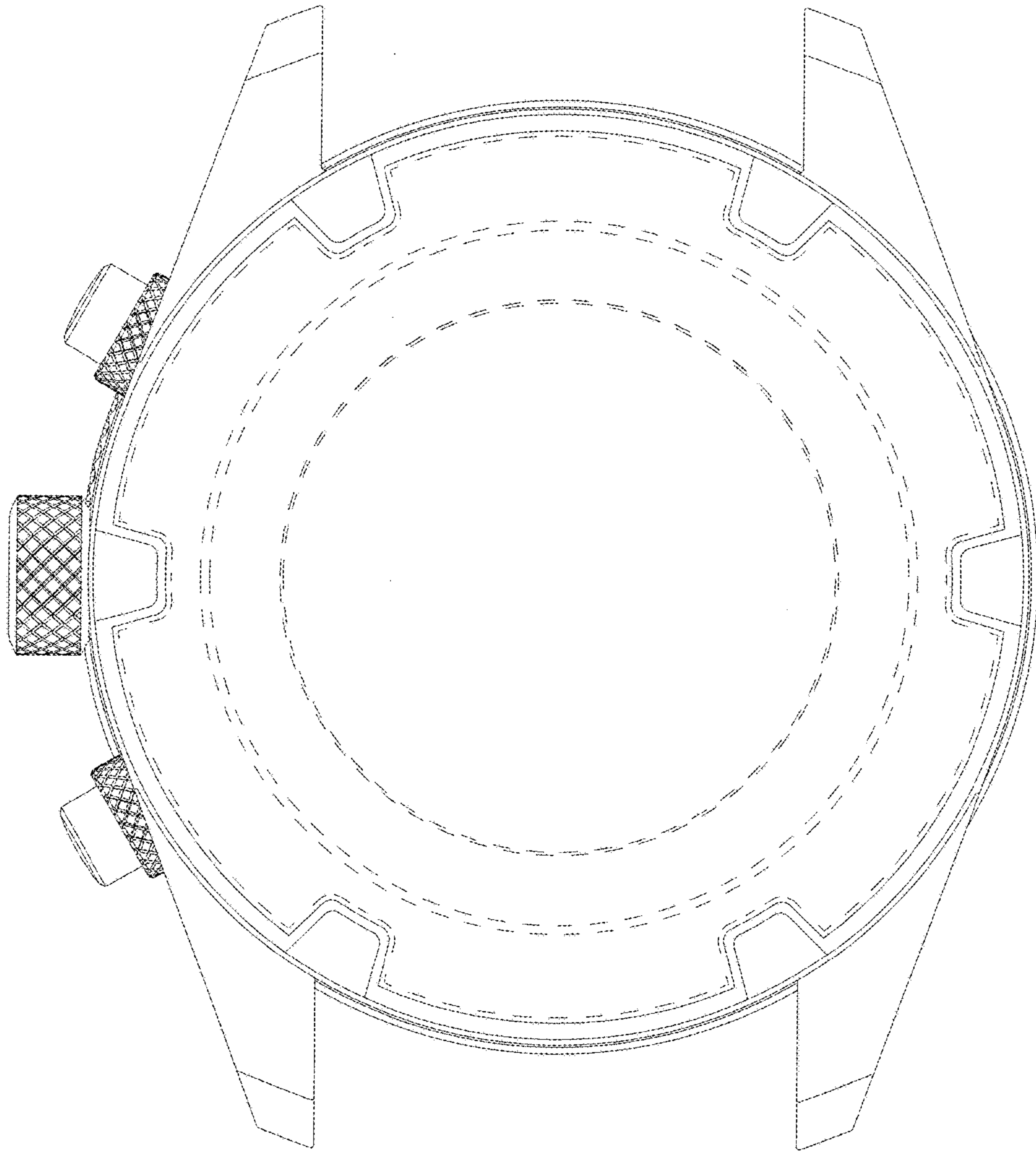

Fig. 2

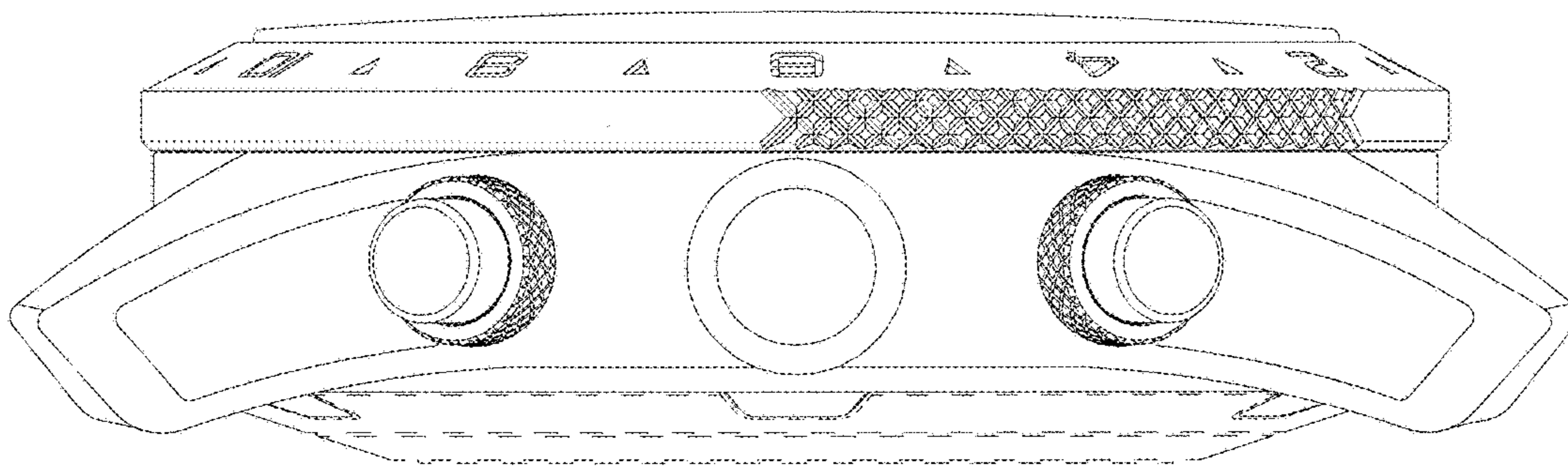

Fig. 3

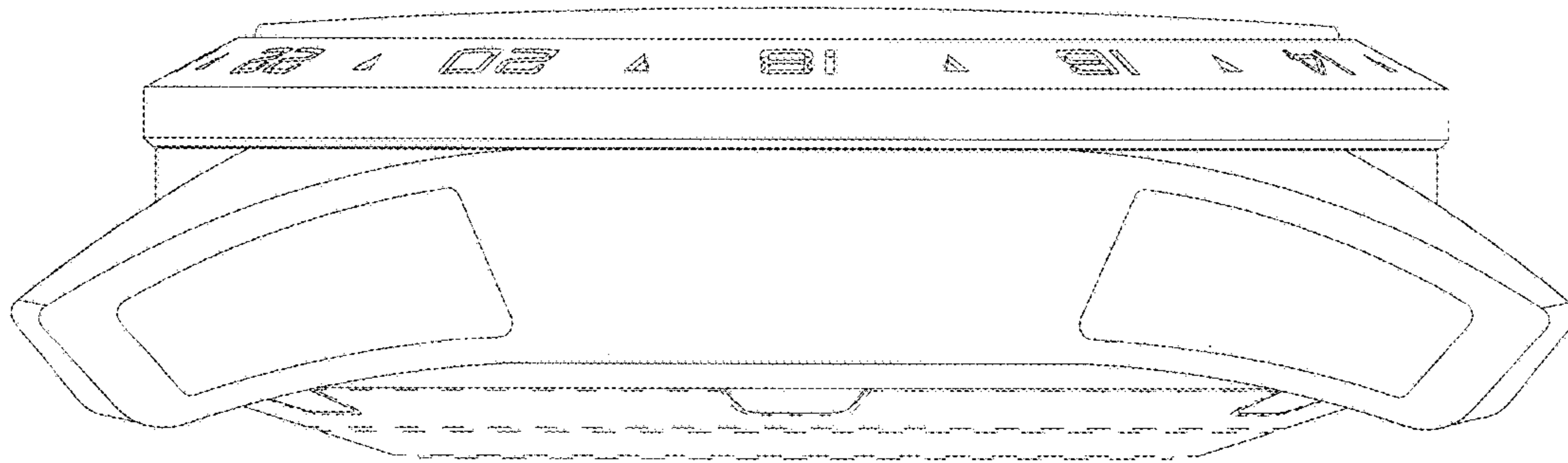

Fig. 4

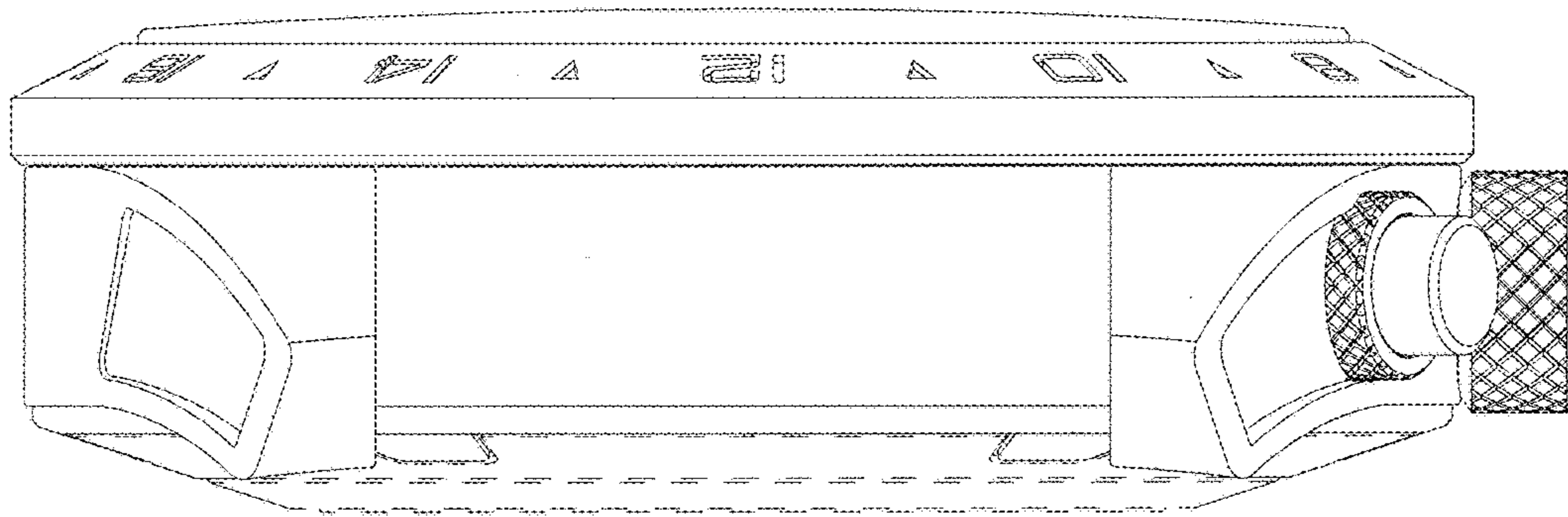

Fig. 5

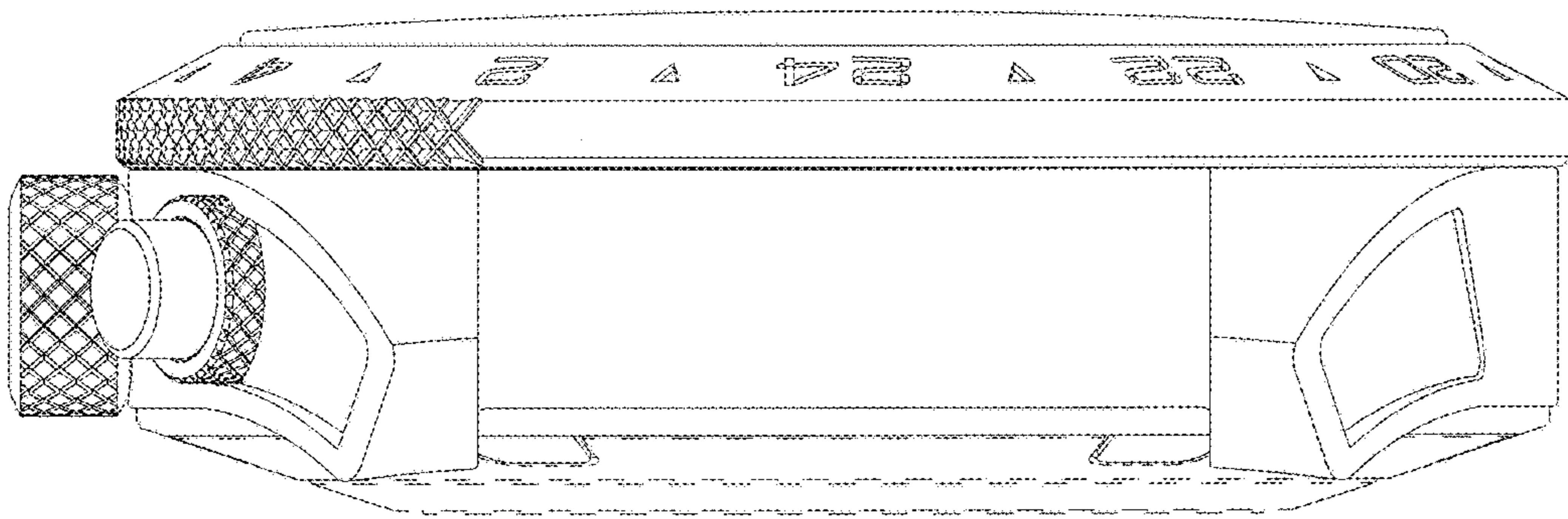

Fig. 6

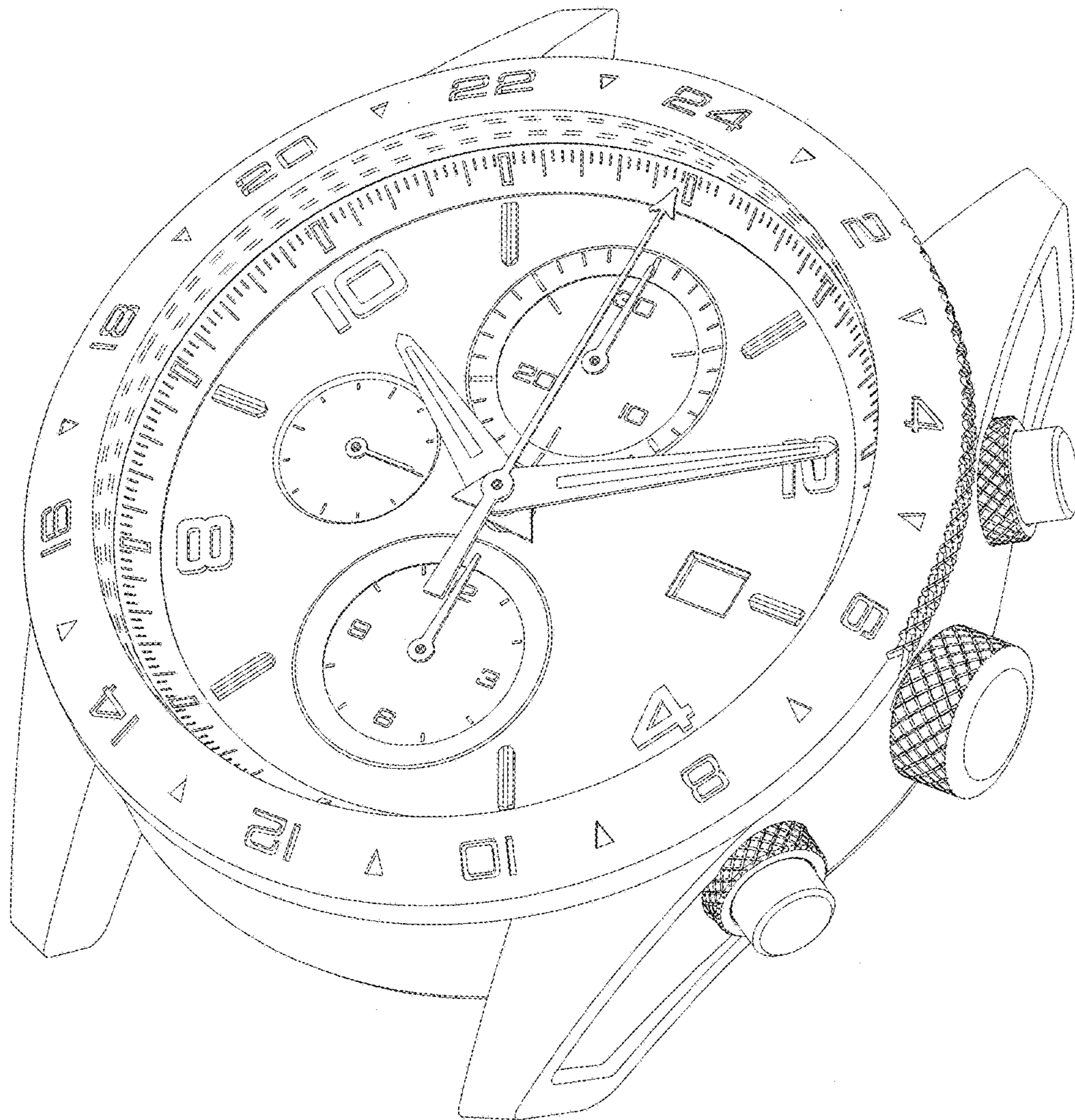

Fig. 7