

US00D820649S

(12) **United States Design Patent**
Sisson

(10) **Patent No.:** **US D820,649 S**
(45) **Date of Patent:** **** Jun. 19, 2018**

(54) **PORTABLE COOLER**

(71) Applicant: **Michael T. Sisson**, Leawood, KS (US)

(72) Inventor: **Michael T. Sisson**, Leawood, KS (US)

(**) Term: **15 Years**

(21) Appl. No.: **29/600,548**

(22) Filed: **Apr. 13, 2017**

(51) **LOC (11) Cl.** **07-01**

(52) **U.S. Cl.**
USPC **D7/607**

(58) **Field of Classification Search**

USPC D7/603-608, 709; D3/201, 203.1-203.8,
D3/202, 232, 254, 273, 274

CPC A45F 3/16; F25D 3/08; F25D 3/14; A45C
11/20; B65D 81/3886; B65D 81/3834;
B65D 81/3897; B65D 81/3813; B65D

(Continued)

(56) **References Cited**

U.S. PATENT DOCUMENTS

2,954,891 A * 10/1960 Imber B65D 81/3834
220/592.2
4,514,993 A * 5/1985 Johnson F25D 3/08
383/110

(Continued)

Primary Examiner — Terry A Wallace

(74) *Attorney, Agent, or Firm* — Hovey Williams LLP

(57) **CLAIM**

The ornamental design for a portable cooler, as shown and described.

DESCRIPTION

FIG. 1 is a top perspective view of an embodiment of the portable cooler of the present invention with its lid closed;

FIG. 2 is a bottom perspective view of the portable cooler of FIG. 1;

FIG. 3 is a front elevational view of the portable cooler of FIG. 1;

FIG. 4 is rear elevational view of the portable cooler of FIG. 1;

FIG. 5 is a left side elevational view of the portable cooler of FIG. 1;

FIG. 6 is a right side elevational view of the portable cooler of FIG. 1;

FIG. 7 is a top plan view of the portable cooler of FIG. 1;

FIG. 8 is a bottom plan view of the portable cooler of FIG. 1;

FIG. 9 is a top perspective view of the portable cooler of FIG. 1 with its lid opened;

FIG. 10 is a top perspective view of the portable cooler of FIG. 1 with its inner container shown being removed from or inserted into its outer sleeve;

FIG. 11 is a top perspective view of another embodiment of the portable cooler of the present invention with its lid closed;

FIG. 12 is a bottom perspective view of the portable cooler of FIG. 11;

FIG. 13 is a front elevational view of the portable cooler of FIG. 11;

FIG. 14 is rear elevational view of the portable cooler of FIG. 11;

FIG. 15 is a left side elevational view of the portable cooler of FIG. 11;

FIG. 16 is a right side elevational view of the portable cooler of FIG. 11;

FIG. 17 is a top plan view of the portable cooler of FIG. 11;

FIG. 18 is a bottom plan view of the portable cooler of FIG. 11;

FIG. 19 is a top perspective view of the portable cooler of FIG. 11 with its lid opened; and,

FIG. 20 is a top perspective view of the portable cooler of FIG. 11 with its inner container shown being removed from or inserted into its outer sleeve.

1 Claim, 12 Drawing Sheets

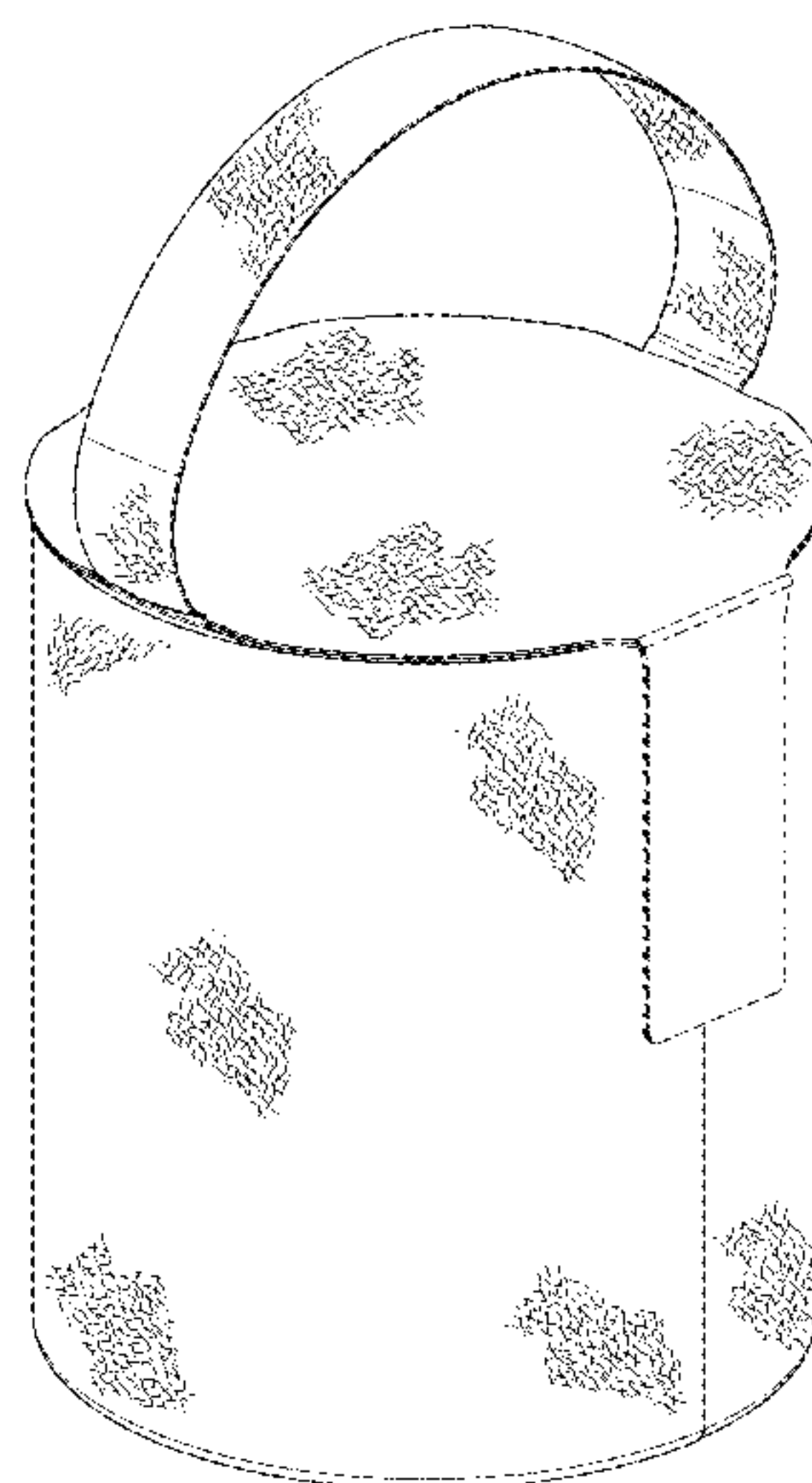

(58) **Field of Classification Search**

CPC 81/3823; B65D 81/3816; B65D 81/3888;
B65D 21/086

See application file for complete search history.

(56) **References Cited**

U.S. PATENT DOCUMENTS

4,802,344 A * 2/1989 Livingston A45F 3/16
62/372
6,082,896 A * 7/2000 Pulli B65D 81/3897
383/110
7,815,069 B1 * 10/2010 Bellofatto B65D 81/3886
190/903
D671,372 S * 11/2012 Zou D7/608
8,662,413 B2 * 3/2014 Rotondo B05B 9/0861
239/152
2003/0106895 A1 * 6/2003 Kalal B65D 21/086
220/9.2

* cited by examiner

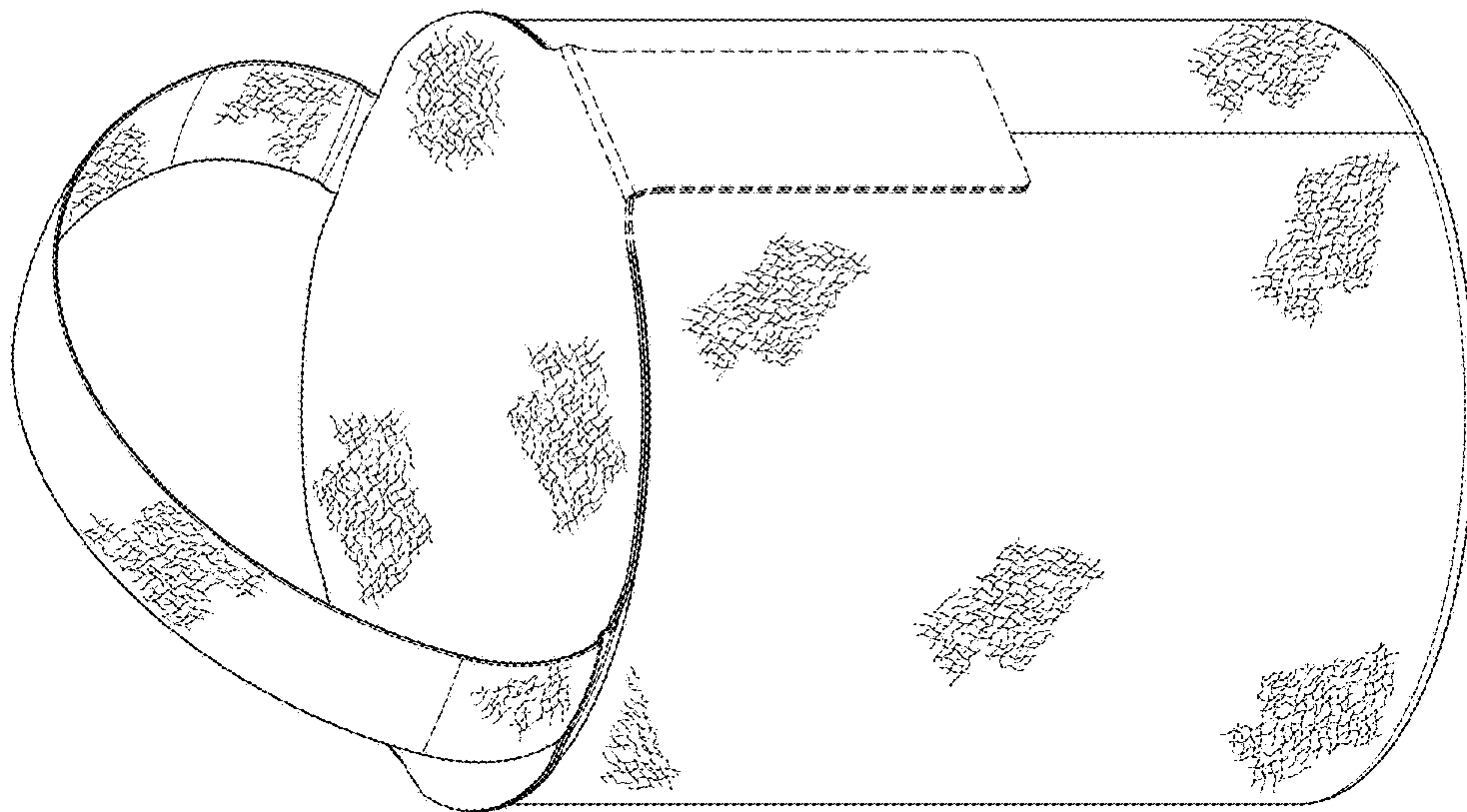

Fig. 1.

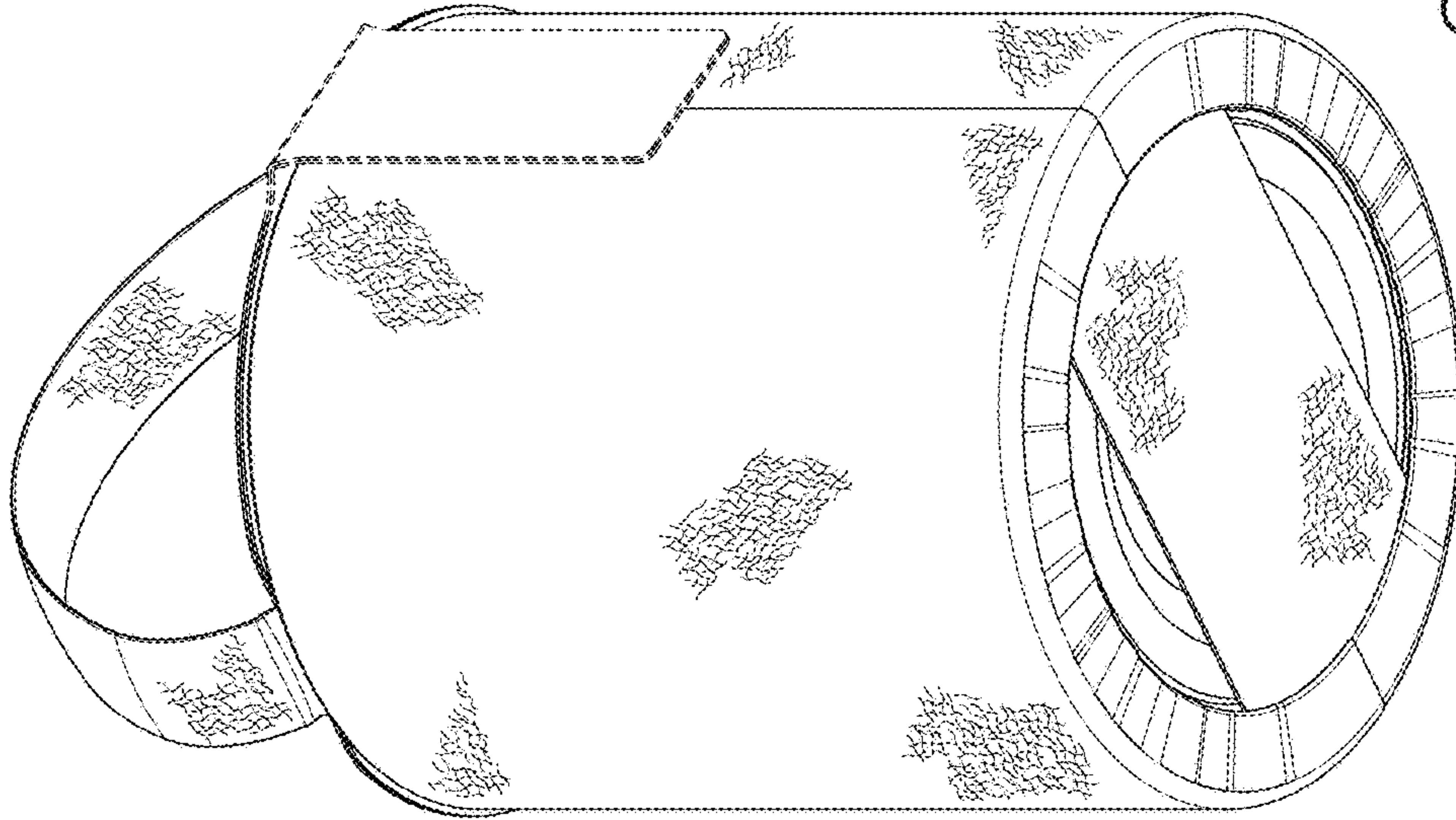

Fig. 2.

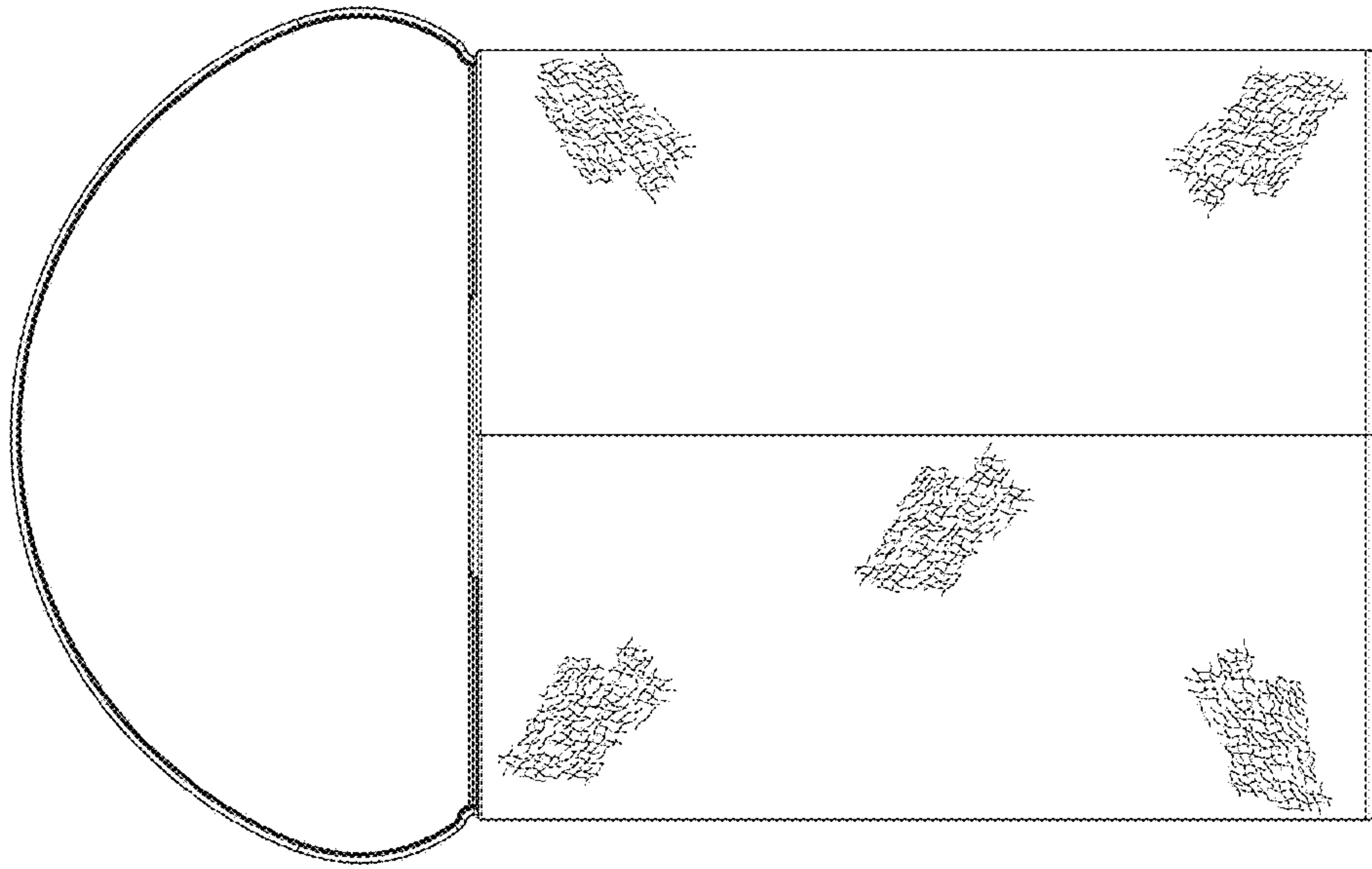

Fig. 4.

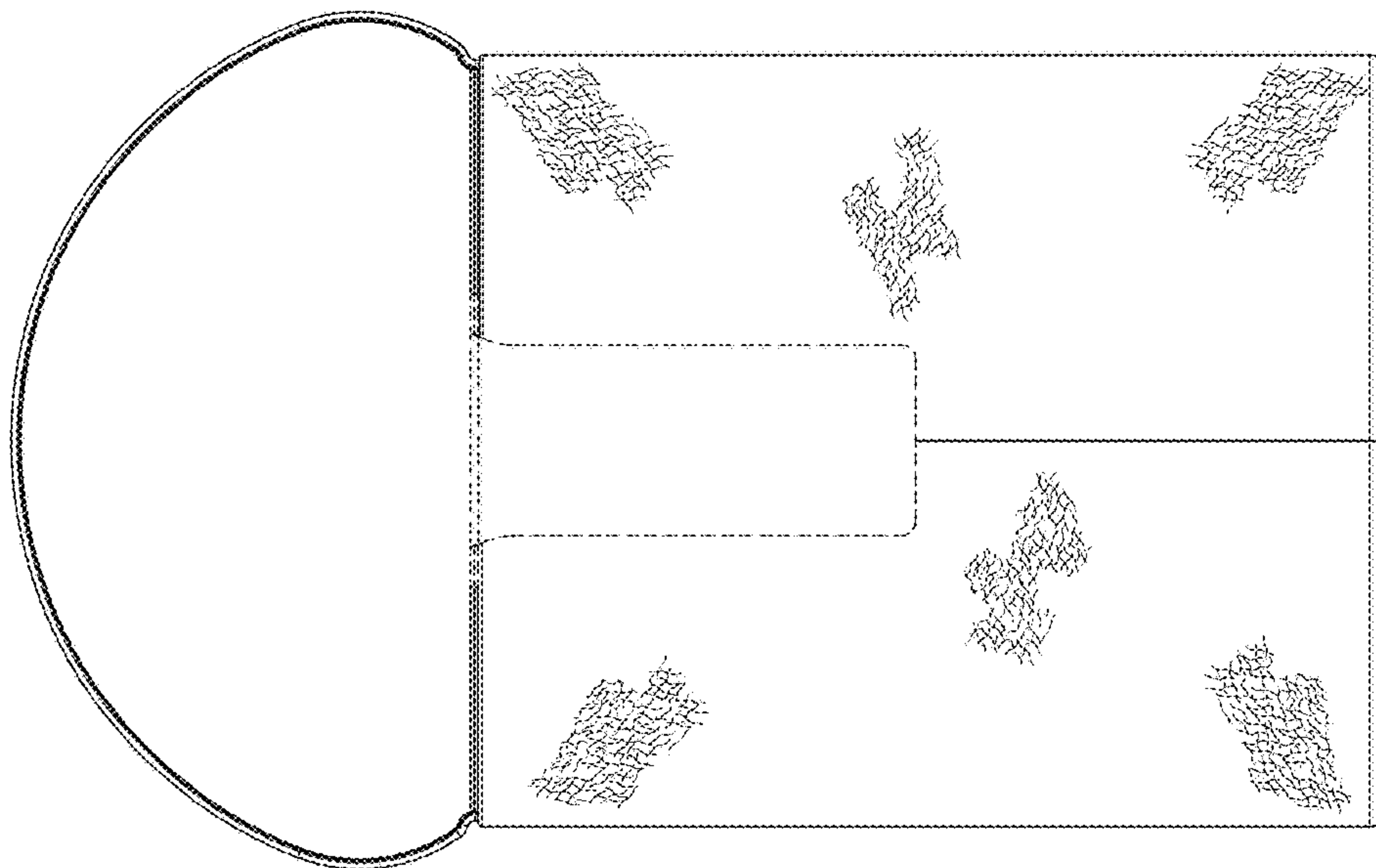

Fig. 3.

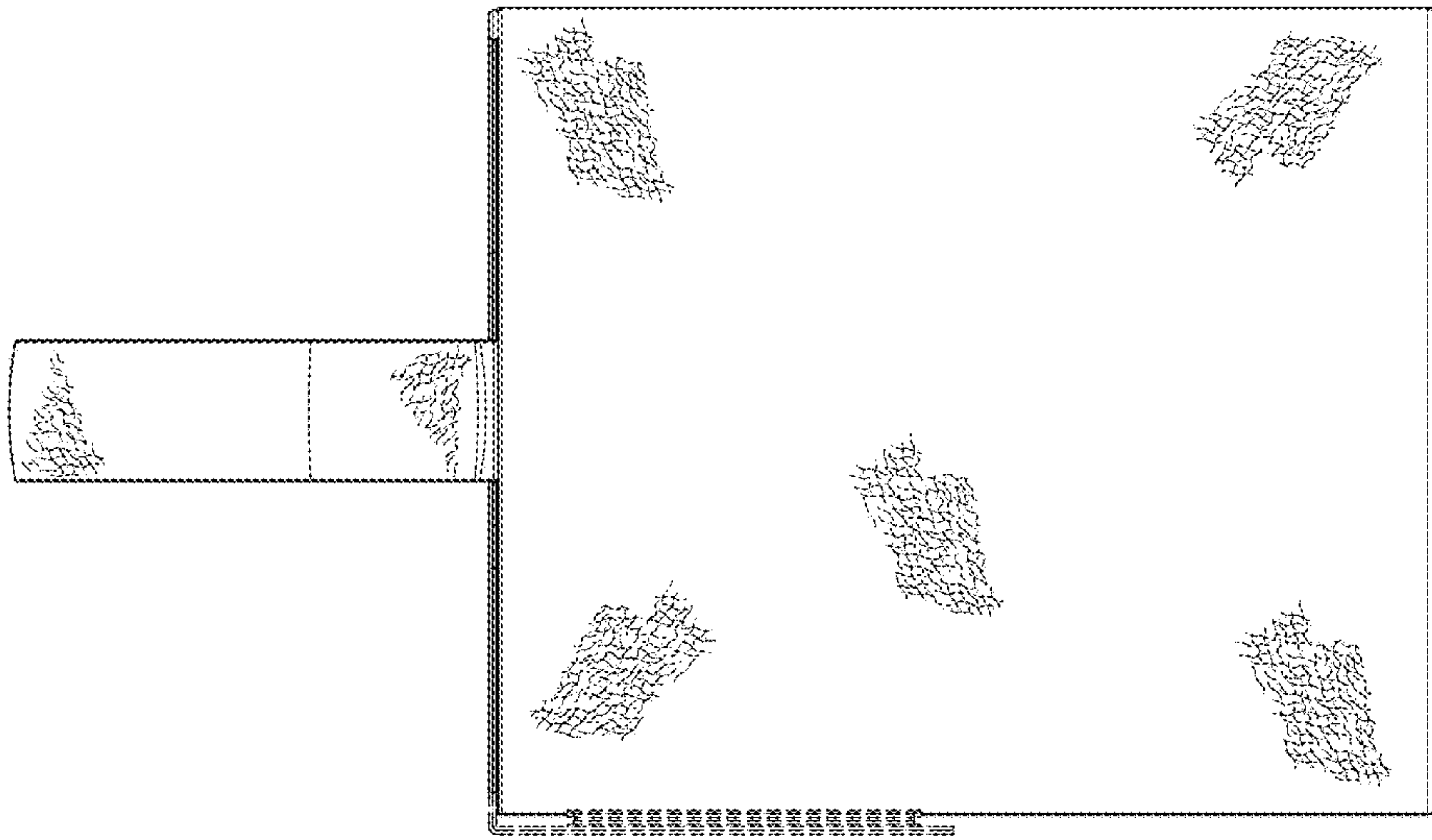

Fig. 5.

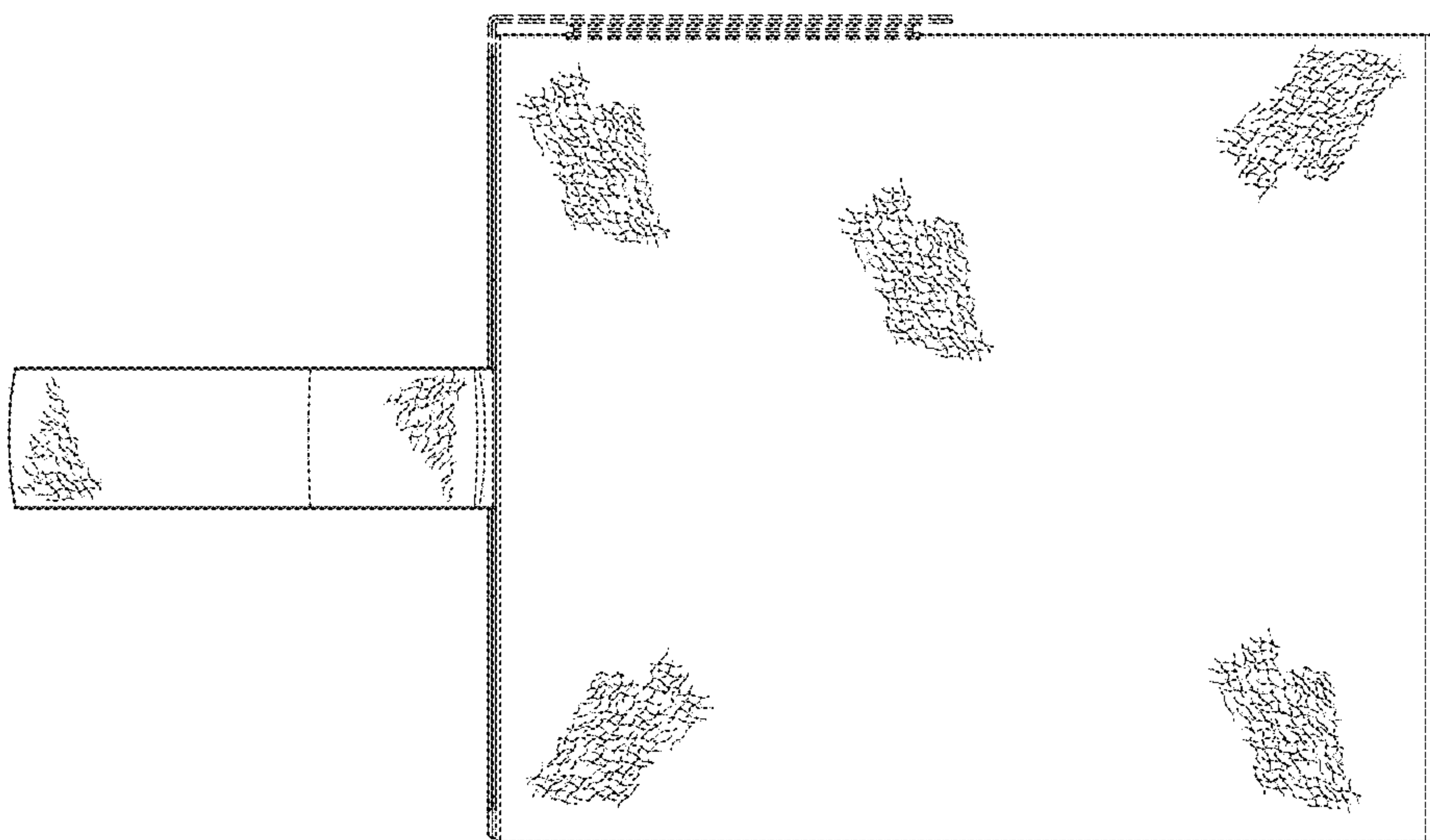

Fig. 6.

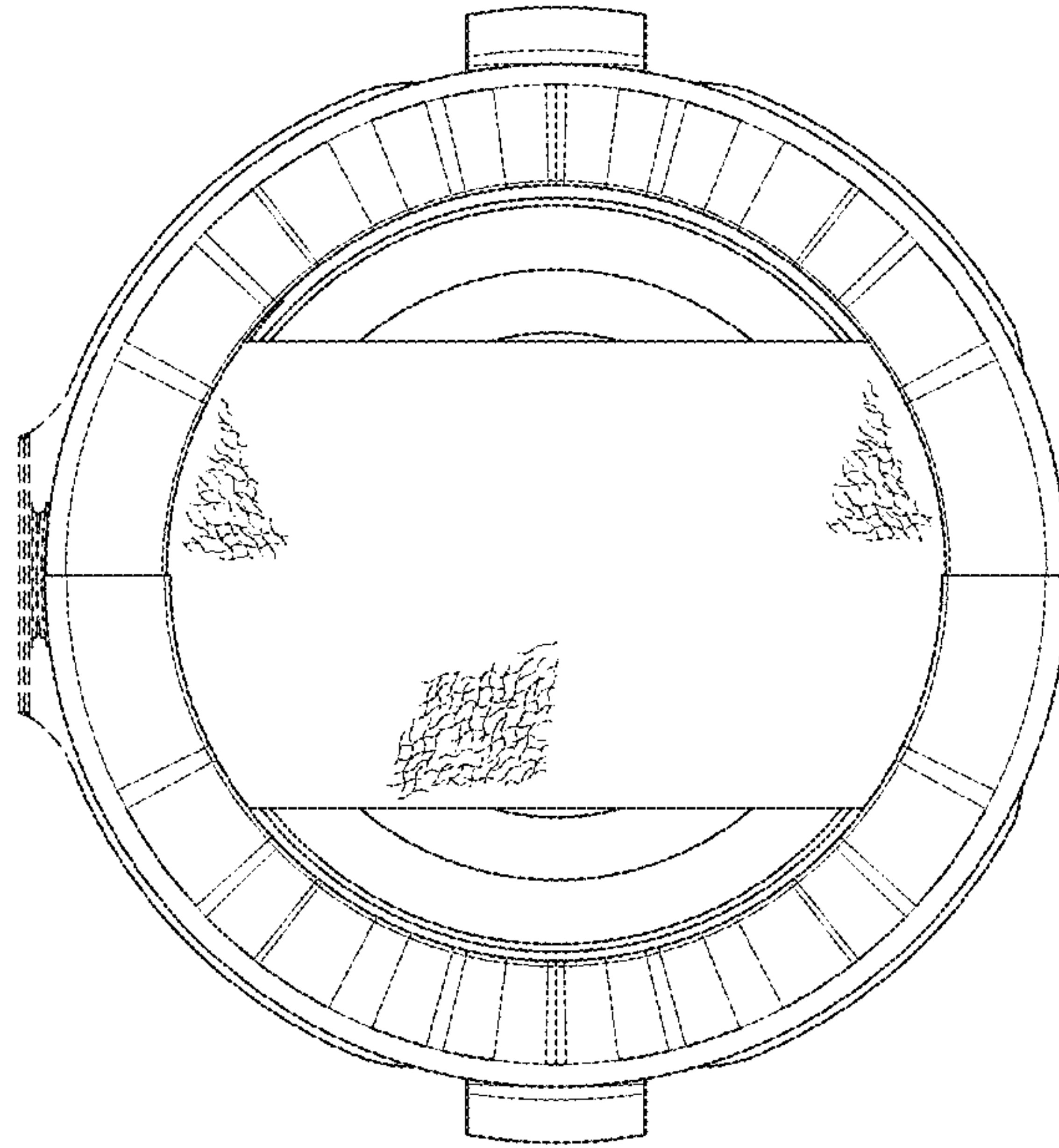

Fig. 8.

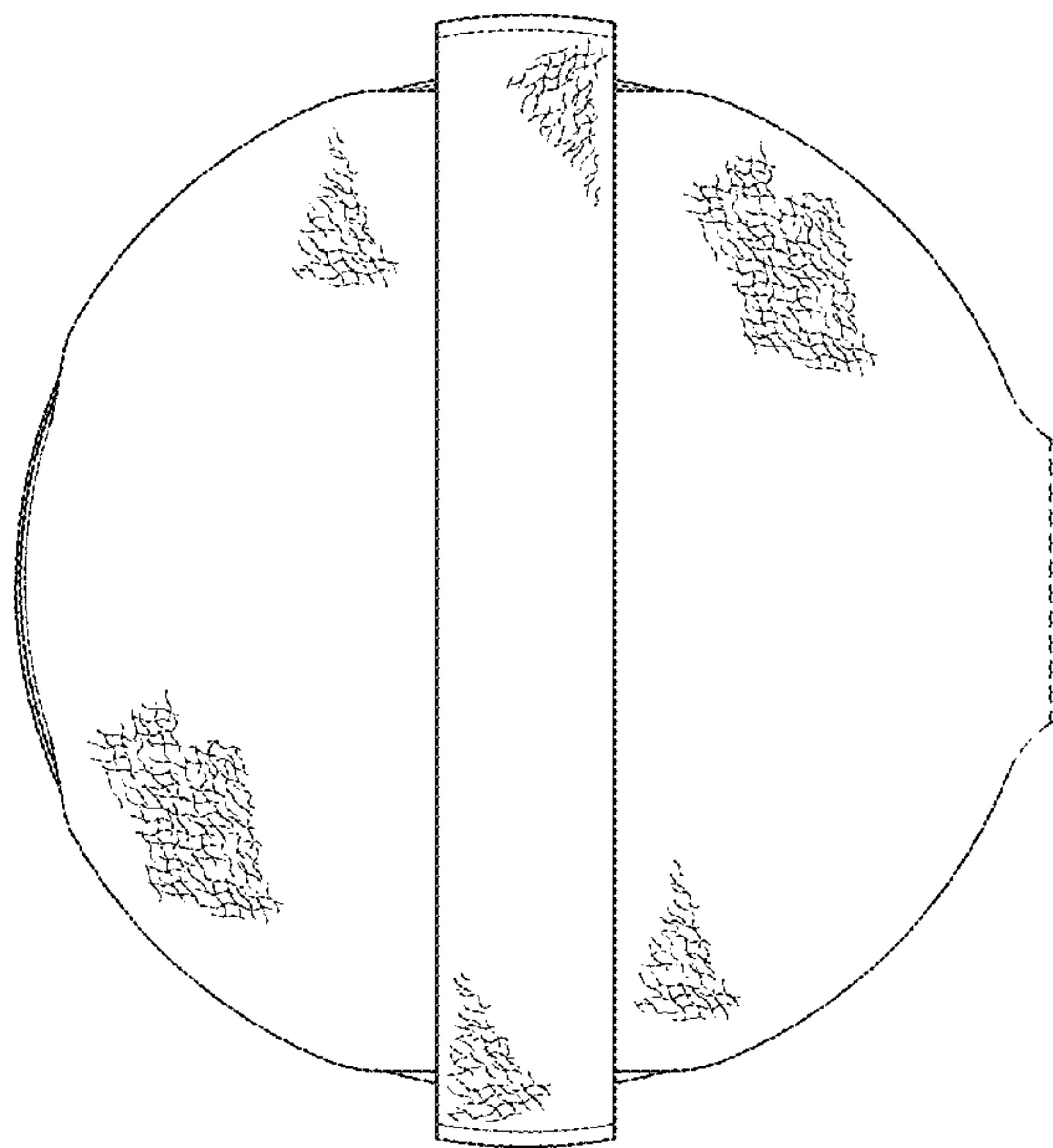

Fig. 7.

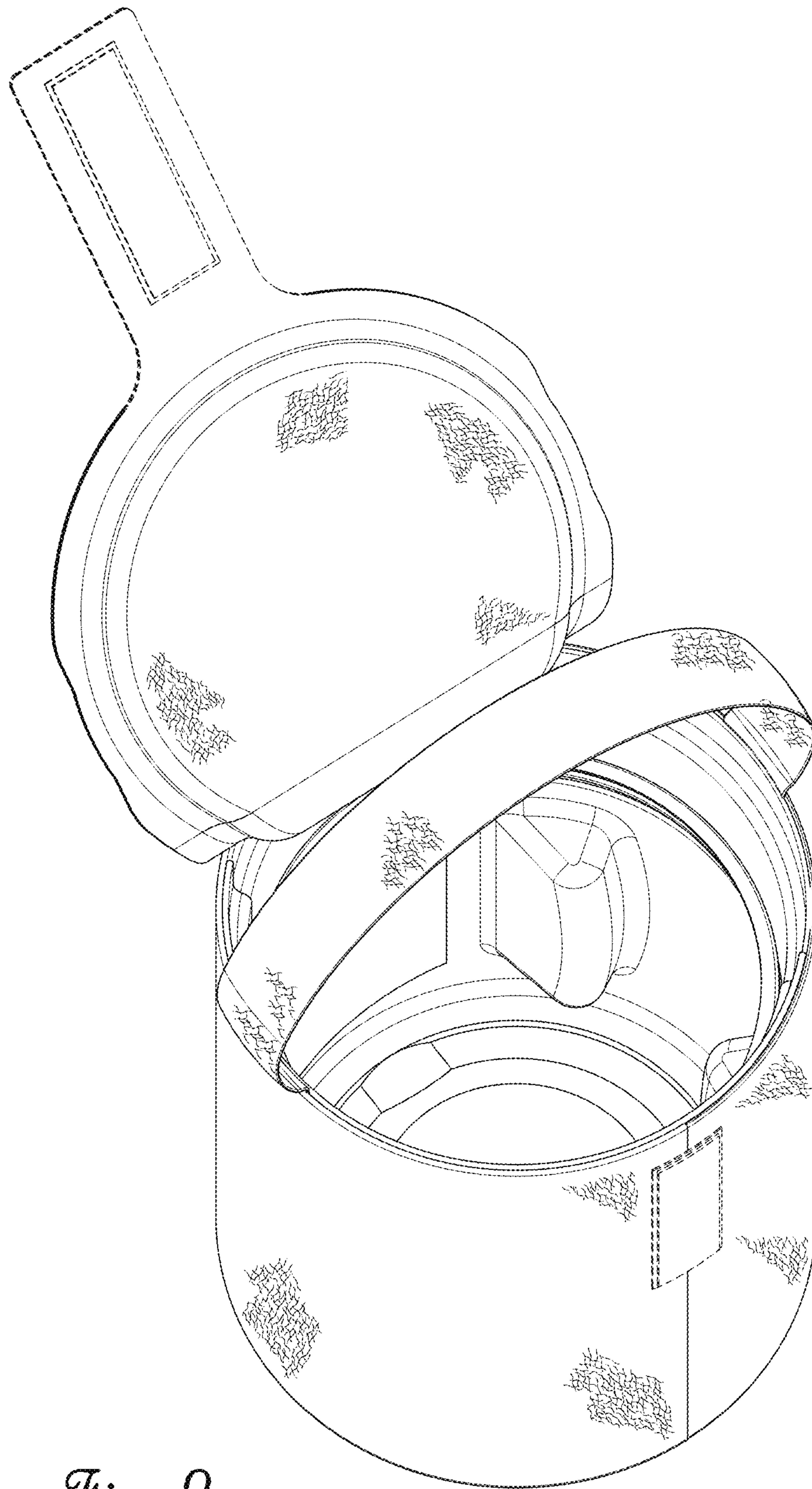

Fig. 9.

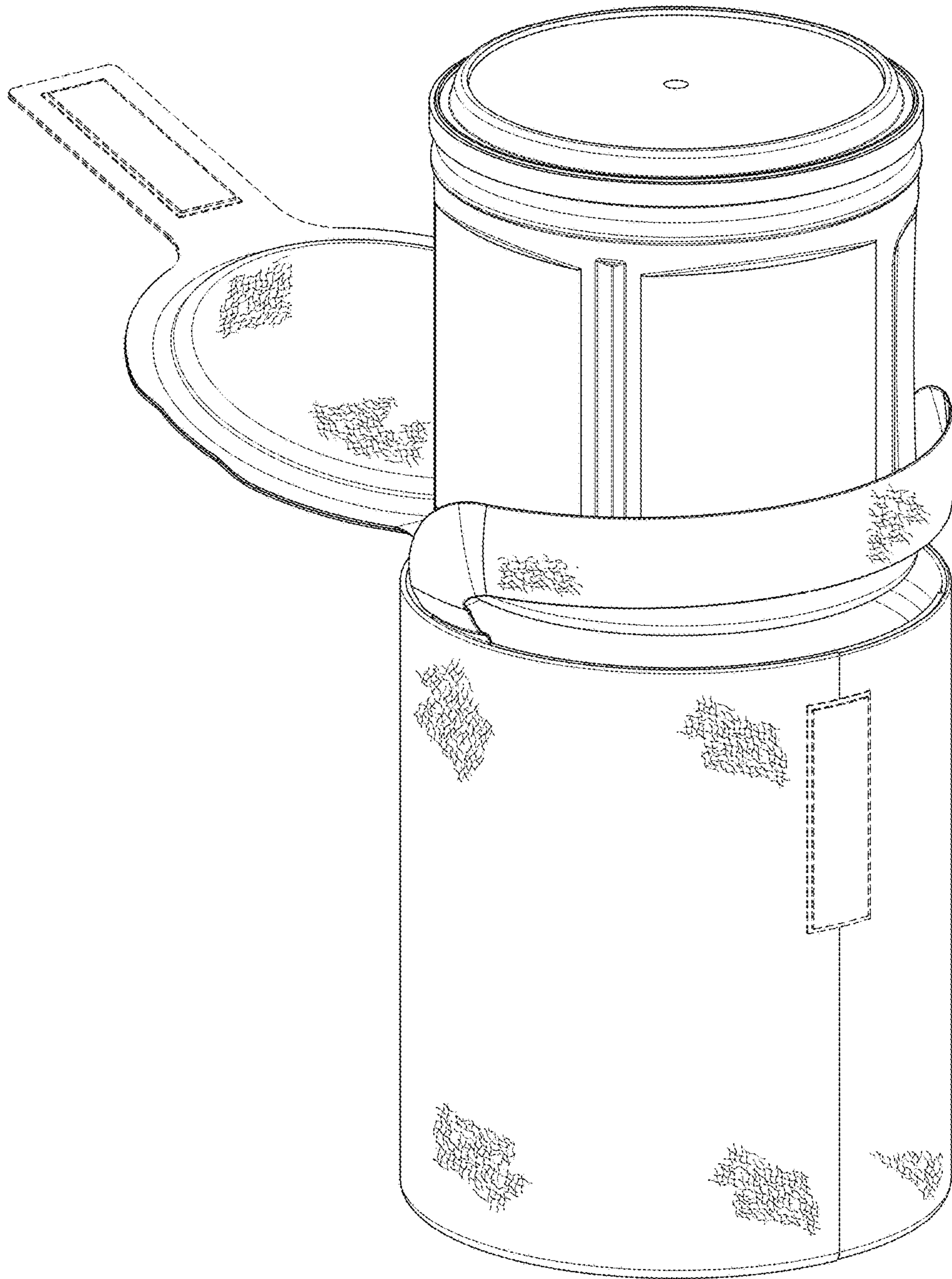

Fig. 10.

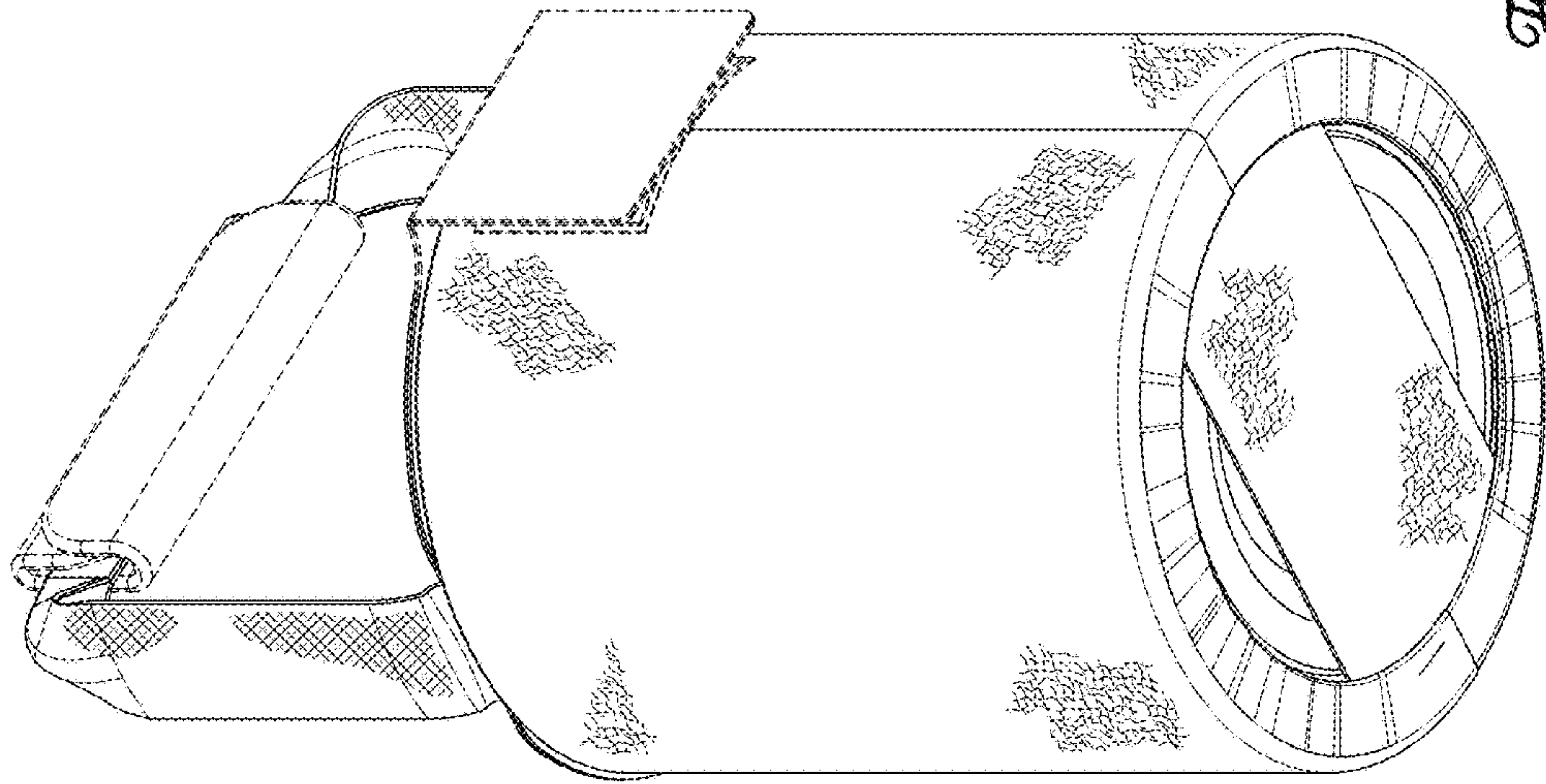

Fig. 12.

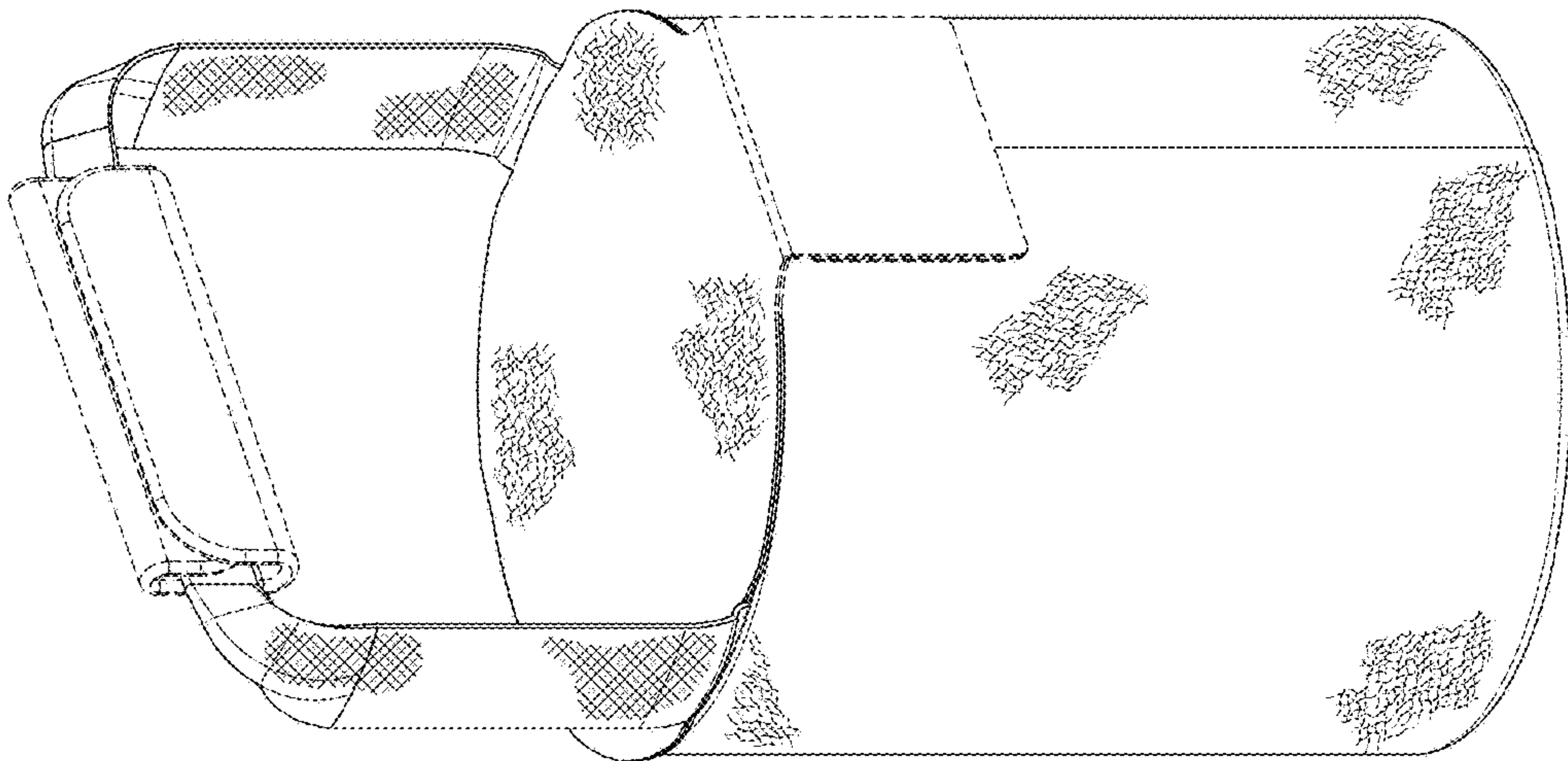

Fig. 11.

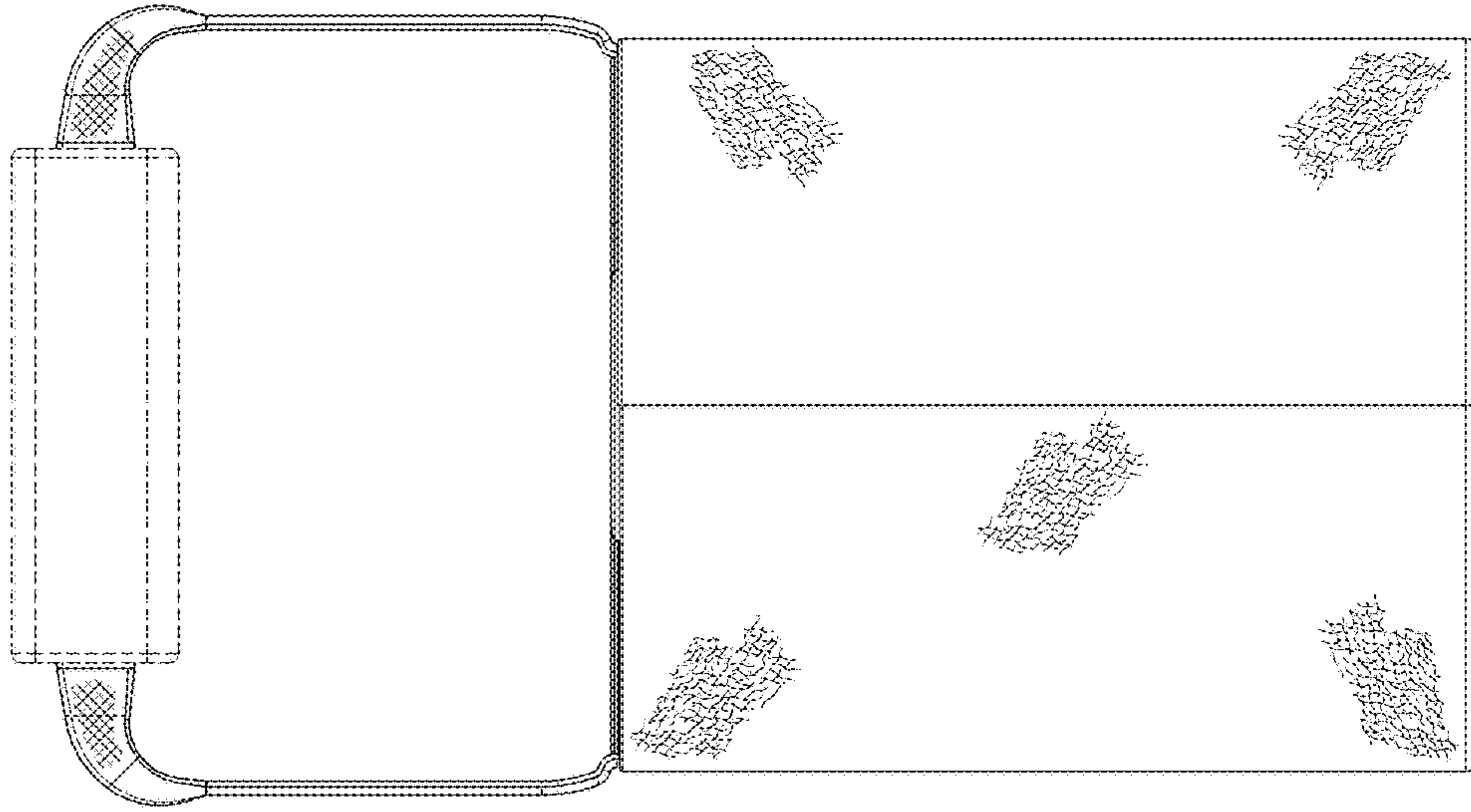

Fig. 14.

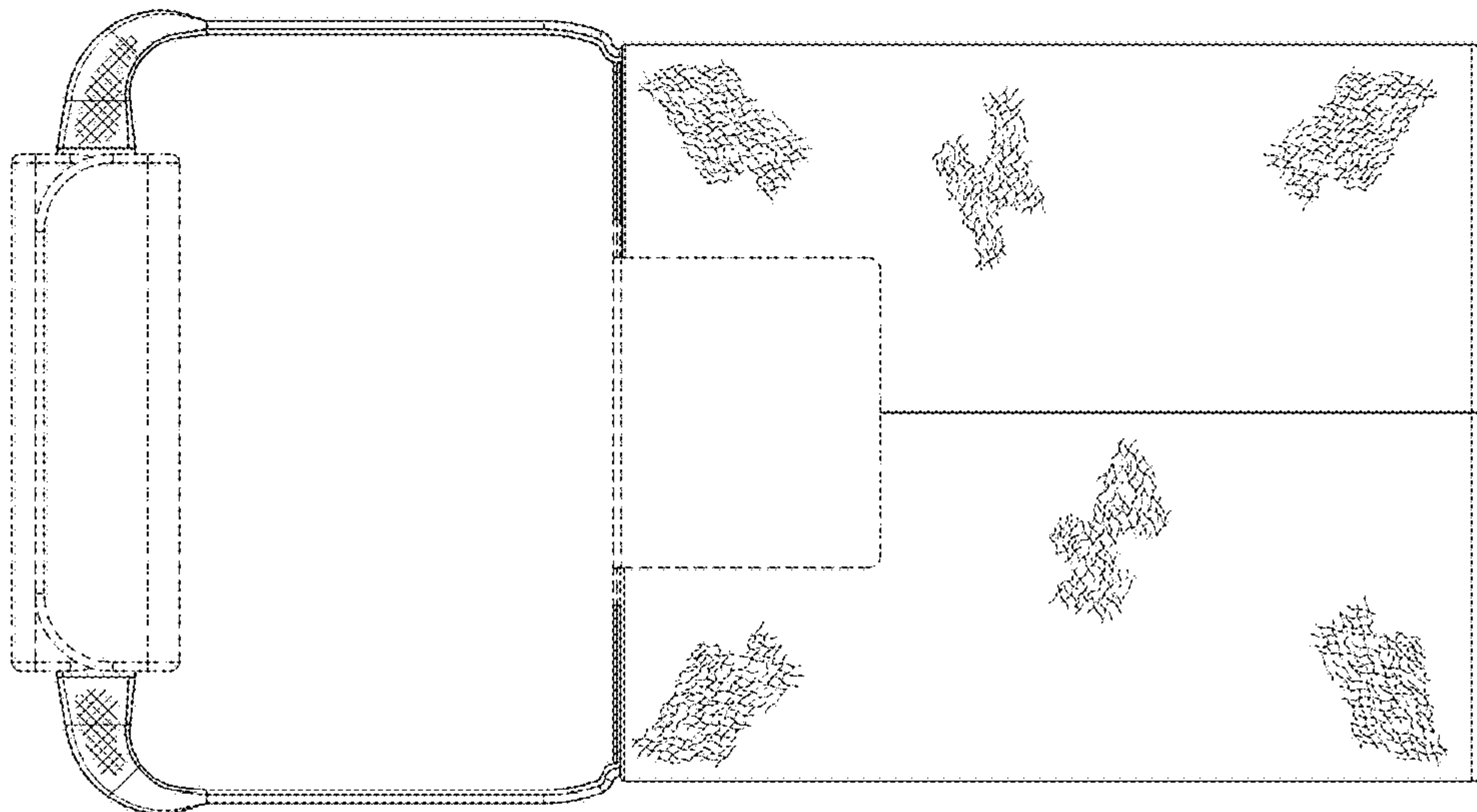

Fig. 13.

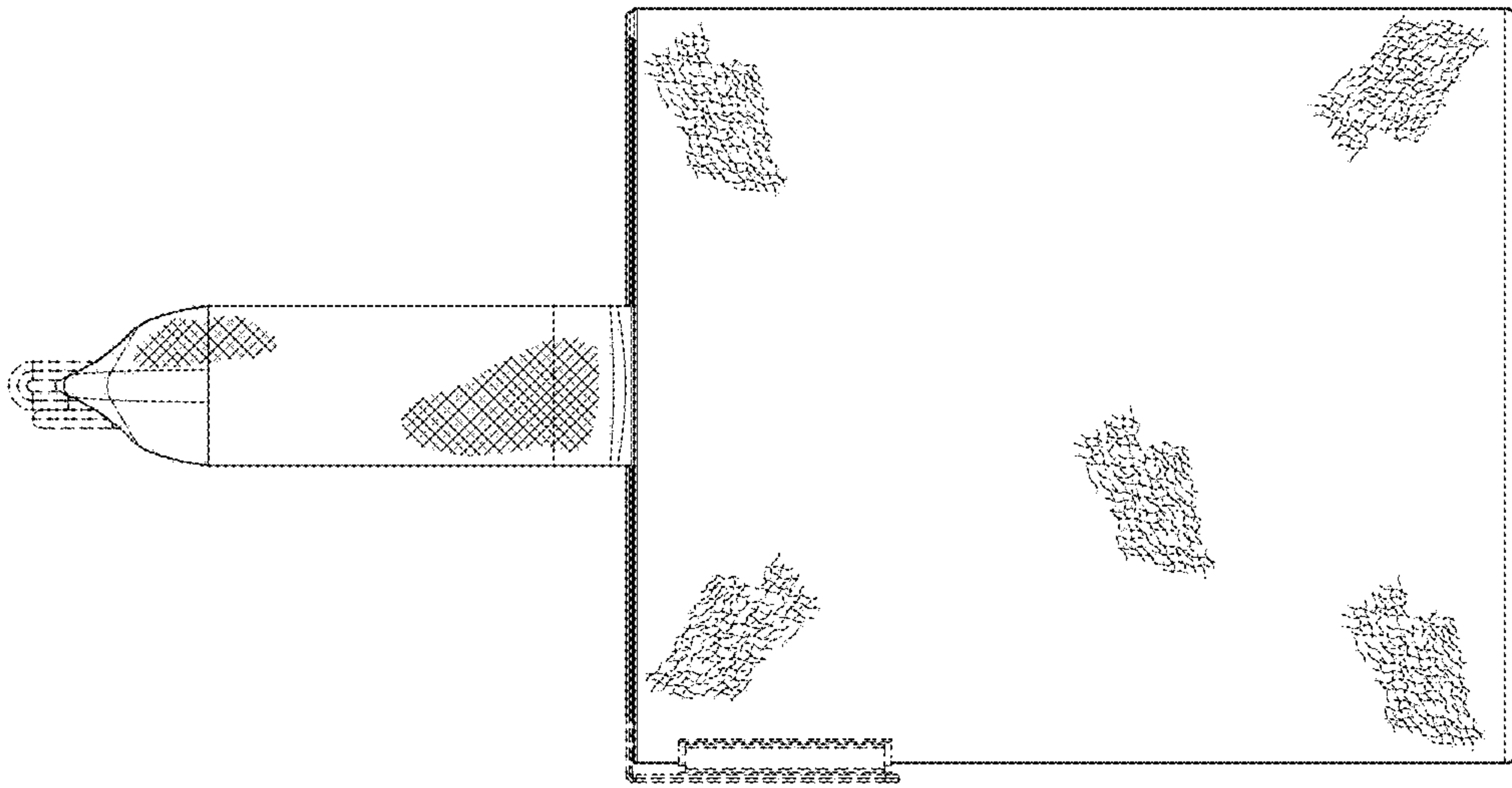

Fig. 15.

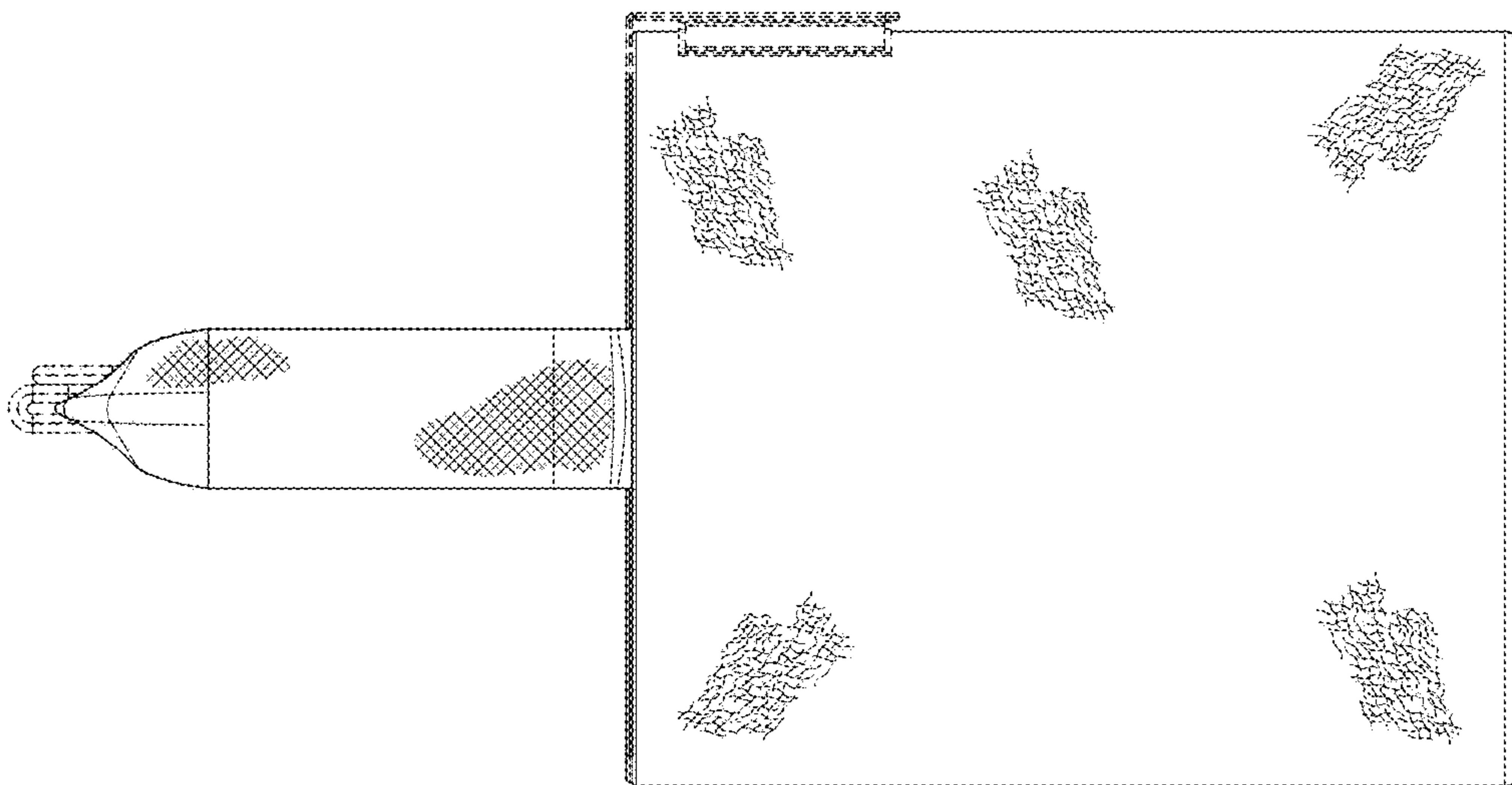

Fig. 16.

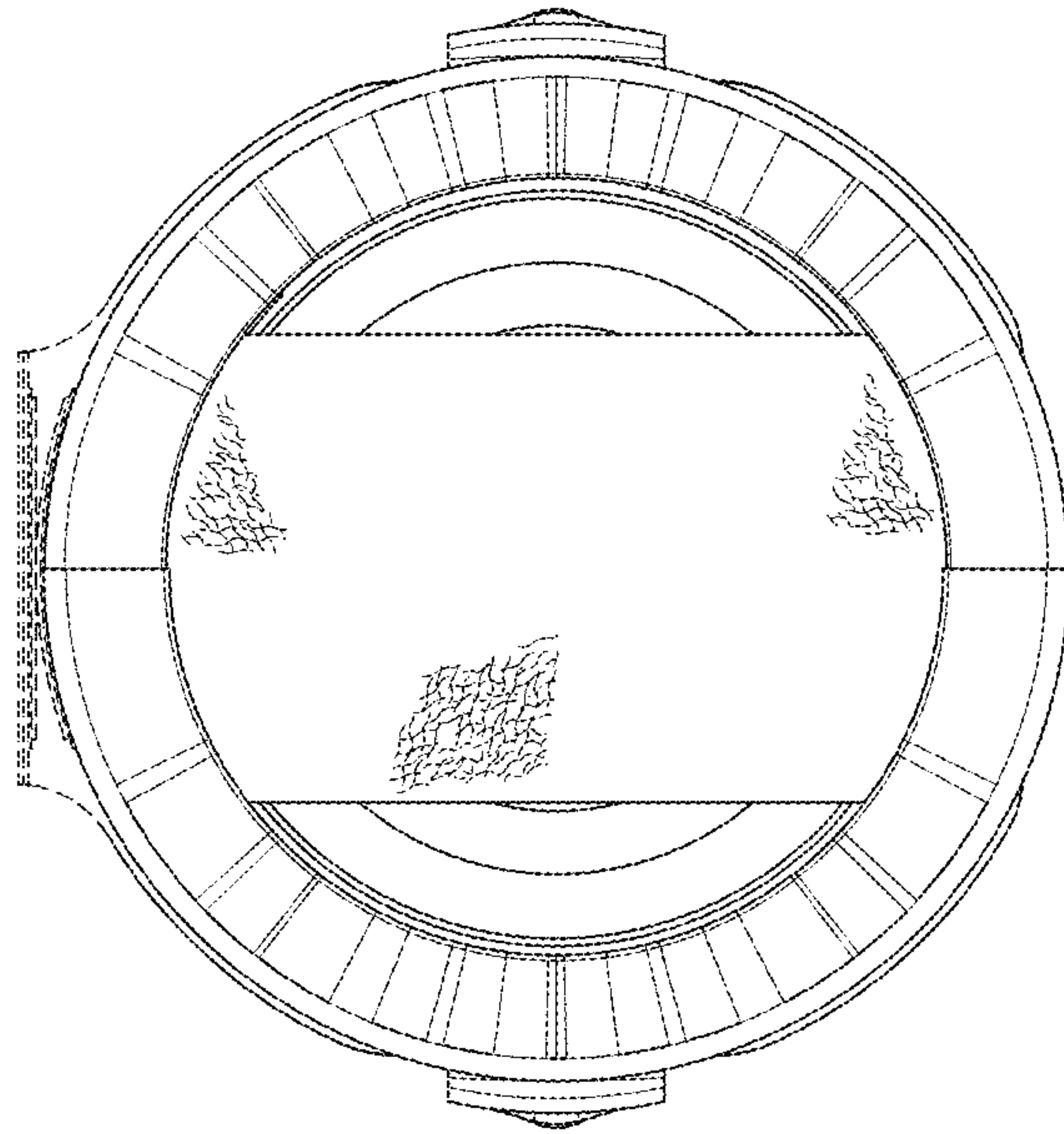

Fig. 17.

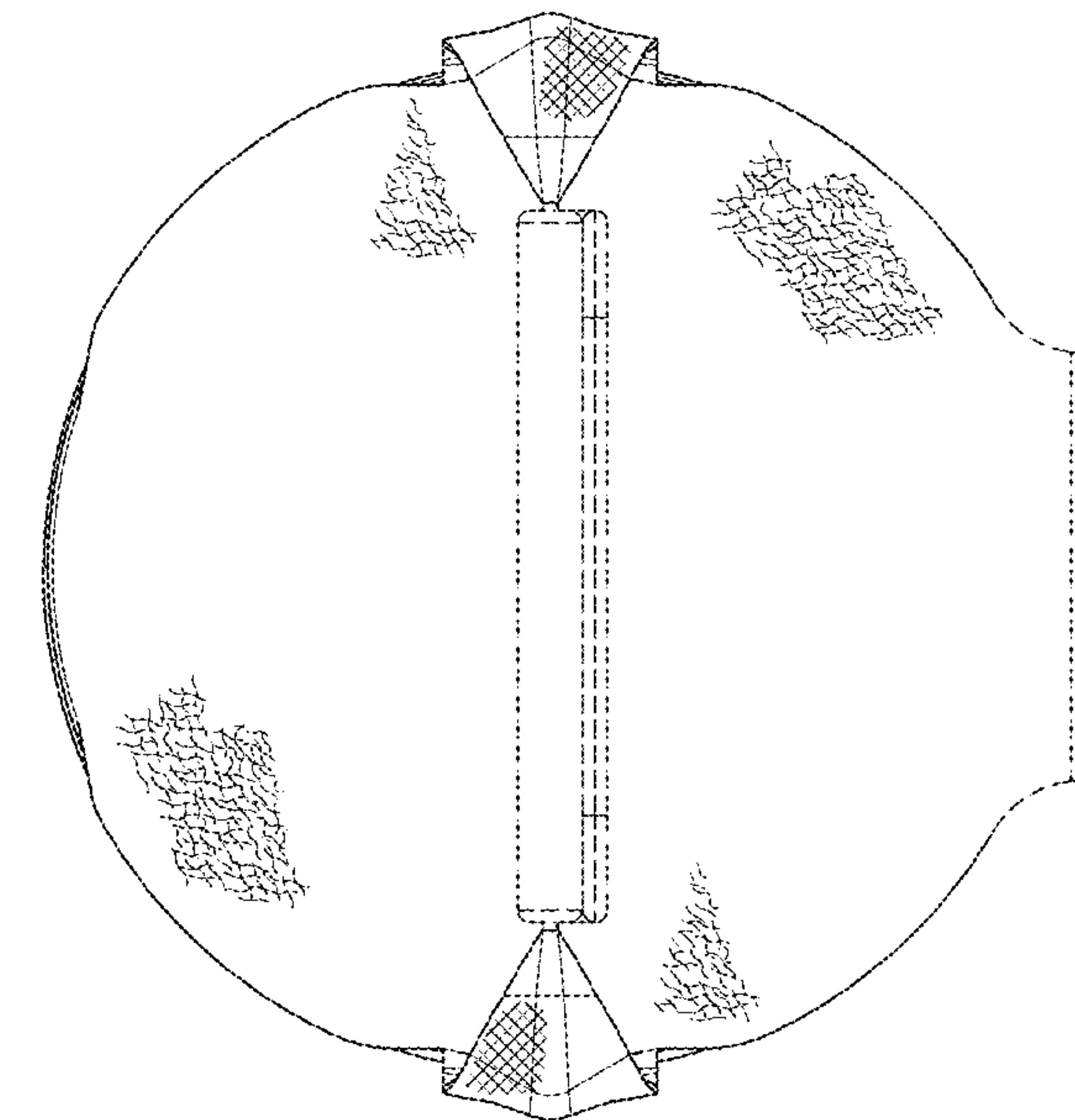

Fig. 18.

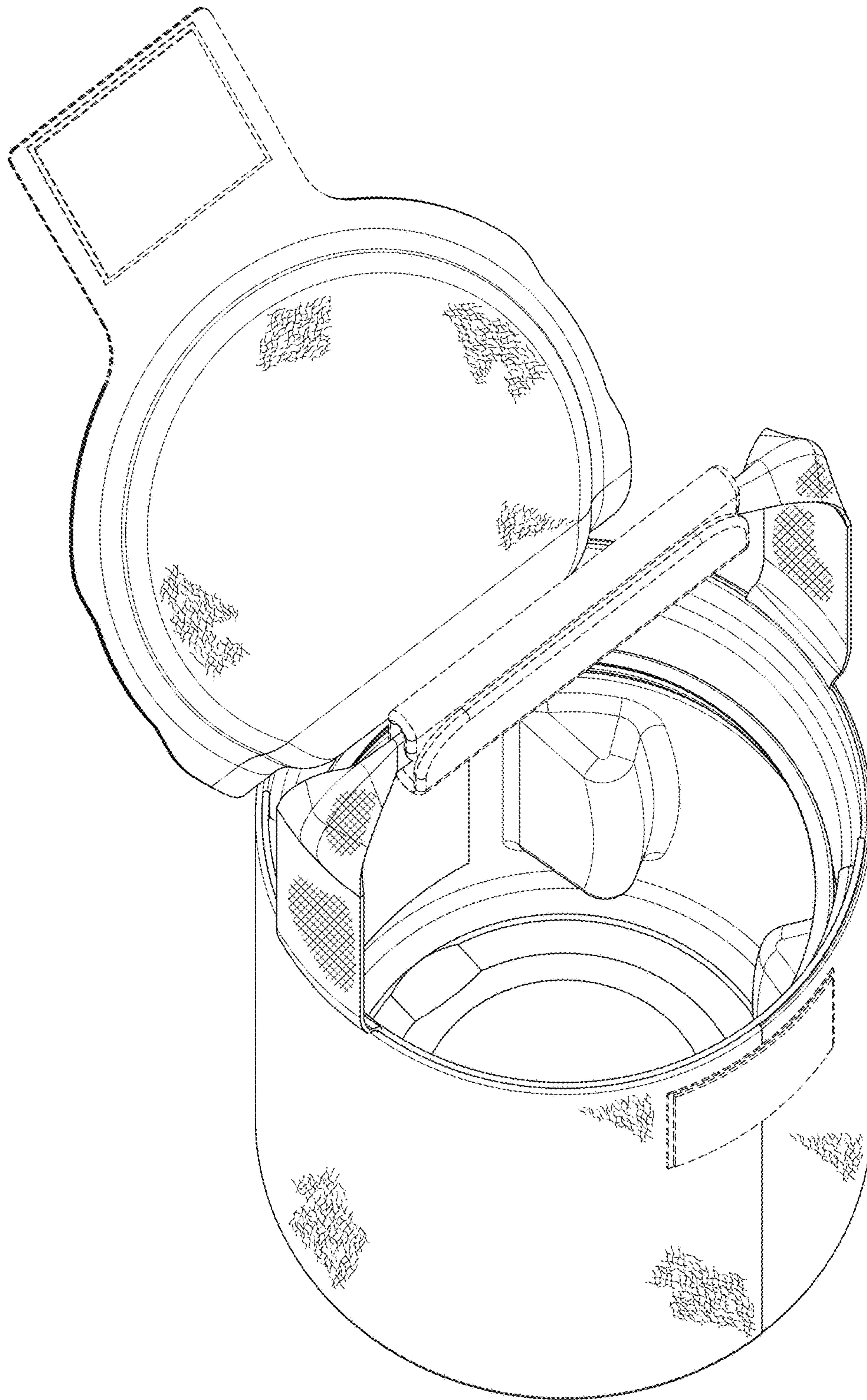

Fig. 19.

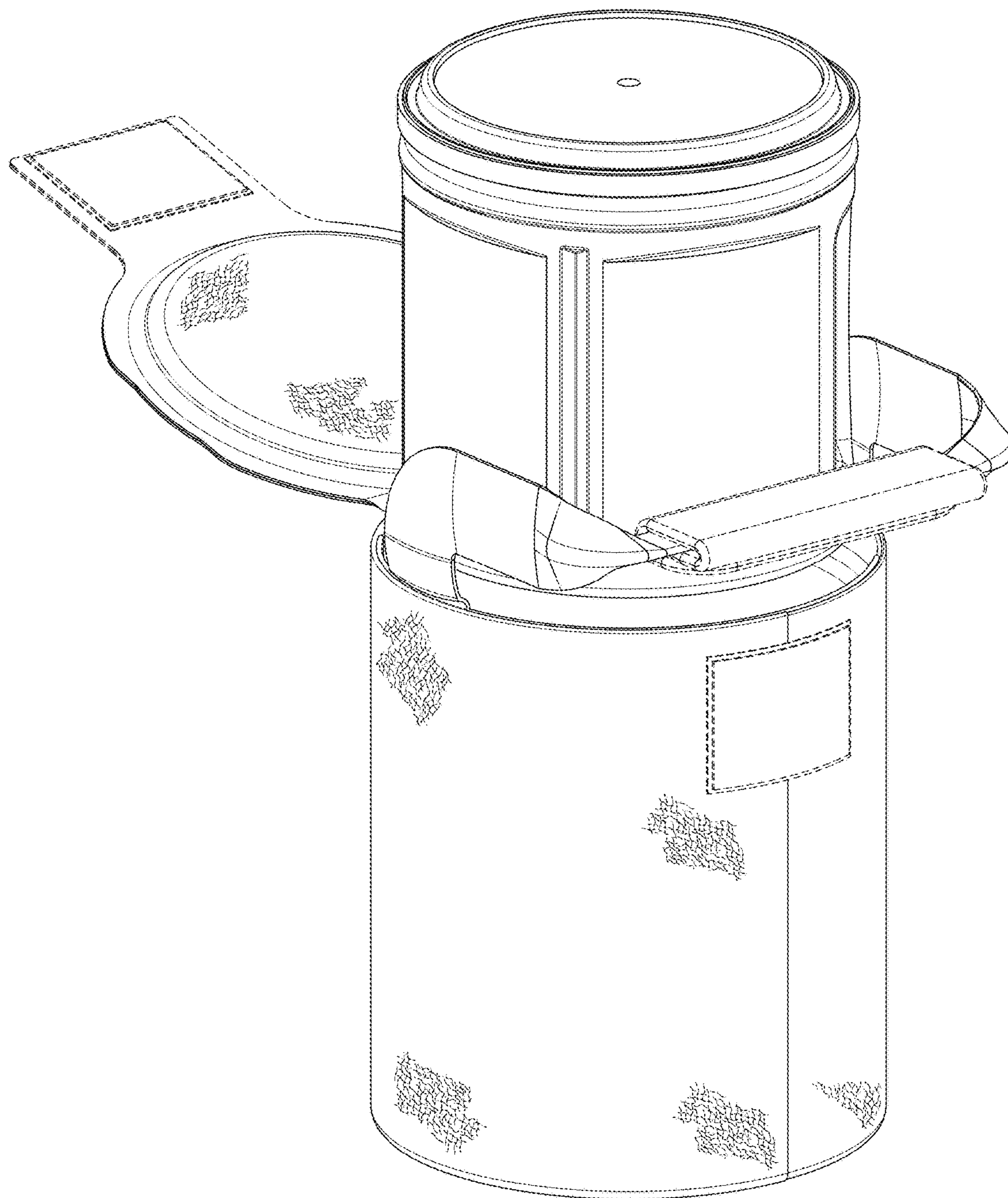

Fig. 20.