



US00D820432S

(12) **United States Design Patent**  
**Scheiner et al.**

(10) **Patent No.:** **US D820,432 S**  
(45) **Date of Patent:** **\*\* Jun. 12, 2018**

(54) **MASK**

(75) Inventors: **Rupert Christian Scheiner**, Davidson (AU); **Steven John Lubke**, Stanmore (AU); **James William Charles Vandyke**, Glebe (AU); **Christopher Scott Skipper**, West Ryde (AU); **Gregory Scott Smart**, Randwick (AU); **Timothy Shawn Nelson**, Amsterdam (NL)

(73) Assignee: **RESMED LIMITED**, Bella Vista (AU)

(\*\*) Term: **14 Years**

(21) Appl. No.: **29/425,101**

(22) Filed: **Jun. 20, 2012**

**Related U.S. Application Data**

(60) Continuation of application No. 29/371,116, filed on Oct. 27, 2010, now Pat. No. Des. 664,250, which is a  
(Continued)

(51) **LOC (11) Cl.** ..... **24-02**

(52) **U.S. Cl.**  
USPC ..... **D24/110**

(58) **Field of Classification Search**  
USPC ..... D24/108–110.5; 128/206.12, 206.19,  
128/206.27, 205.25  
See application file for complete search history.

(56) **References Cited**

**U.S. PATENT DOCUMENTS**

443,191 A 12/1890 Illing  
D439,326 S \* 3/2001 Hecker et al. .... D24/110.5  
(Continued)

*Primary Examiner* — Charles D Hanson

(74) *Attorney, Agent, or Firm* — Nixon & Vanderhye,  
P.C.

(57) **CLAIM**

The ornamental design for a mask, as shown and described.

**DESCRIPTION**

FIG. 1 is an enlarged front perspective view of a mask according to a first embodiment of our new design; FIG. 2 is an enlarged reverse perspective view thereof; FIG. 3 is an enlarged front view thereof; FIG. 4 is an enlarged rear view thereof; FIG. 5 is an enlarged top view thereof; FIG. 6 is an enlarged bottom view thereof; FIG. 7 is an enlarged left side view thereof; FIG. 8 is an enlarged right side view thereof; FIG. 9 is an enlarged front perspective view of a mask according to a second embodiment of our new design; FIG. 10 is an enlarged reverse perspective view thereof; FIG. 11 is an enlarged front view thereof; FIG. 12 is an enlarged rear view thereof; FIG. 13 is an enlarged top view thereof; FIG. 14 is an enlarged bottom view thereof; FIG. 15 is an enlarged left side view thereof; and FIG. 16 is an enlarged right side view thereof. FIG. 17 is a front perspective view of a mask according to the first embodiment of our new design; FIG. 18 is a reverse perspective view thereof; FIG. 19 is a front view thereof; FIG. 20 is a rear view thereof; FIG. 21 is a top view thereof; FIG. 22 is a bottom view thereof; FIG. 23 is a left side view thereof; FIG. 24 is a right side view thereof; FIG. 25 is a front perspective view of a mask according to the second embodiment of our new design; FIG. 26 is a reverse perspective view thereof; FIG. 27 is a front view thereof; FIG. 28 is a rear view thereof; FIG. 29 is a top view thereof; FIG. 30 is a bottom view thereof; FIG. 31 is a left side view thereof; and, FIG. 32 is a right side view thereof.

(Continued)

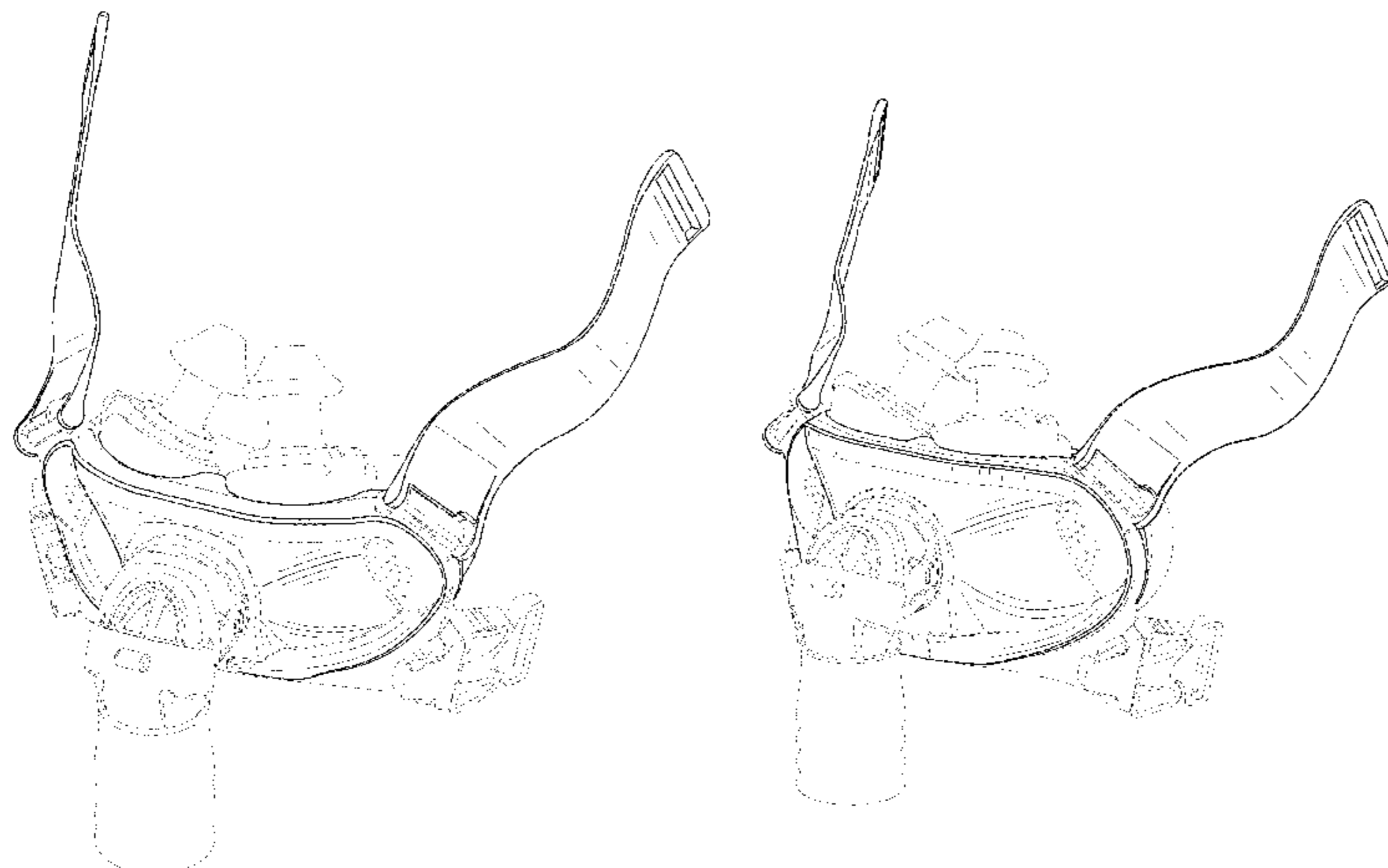

The broken lines indicate unclaimed structure or environment and do not form a part of the claimed design.

**1 Claim, 30 Drawing Sheets**

**Related U.S. Application Data**

division of application No. 29/266,941, filed on Oct. 2, 2006, now Pat. No. Des. 635,247.

(56) **References Cited**

U.S. PATENT DOCUMENTS

6,644,315	B2	11/2003	Ziaee	
D568,985	S *	5/2008	Chandran et al. ....	D24/110.1
D583,048	S *	12/2008	Chandran et al. ....	D24/110.1
D583,049	S *	12/2008	Chandran et al. ....	D24/110.1
D586,910	S *	2/2009	Chandran et al. ....	D24/110.1
D594,111	S *	6/2009	Reid et al. ....	D24/110.1
D595,840	S *	7/2009	Davidson et al. ....	D24/110.1
D597,199	S	7/2009	Smart et al.	
D597,659	S *	8/2009	Chandran et al. ....	D24/110.1
D614,288	S *	4/2010	Judson et al. ....	D24/110.1
D614,763	S *	4/2010	Maurer et al. ....	D24/110.1
D623,288	S *	9/2010	Lubke et al. ....	D24/110.1
D635,247	S	3/2011	Scheiner et al.	
2006/0124131	A1	6/2006	Chandran et al.	

\* cited by examiner

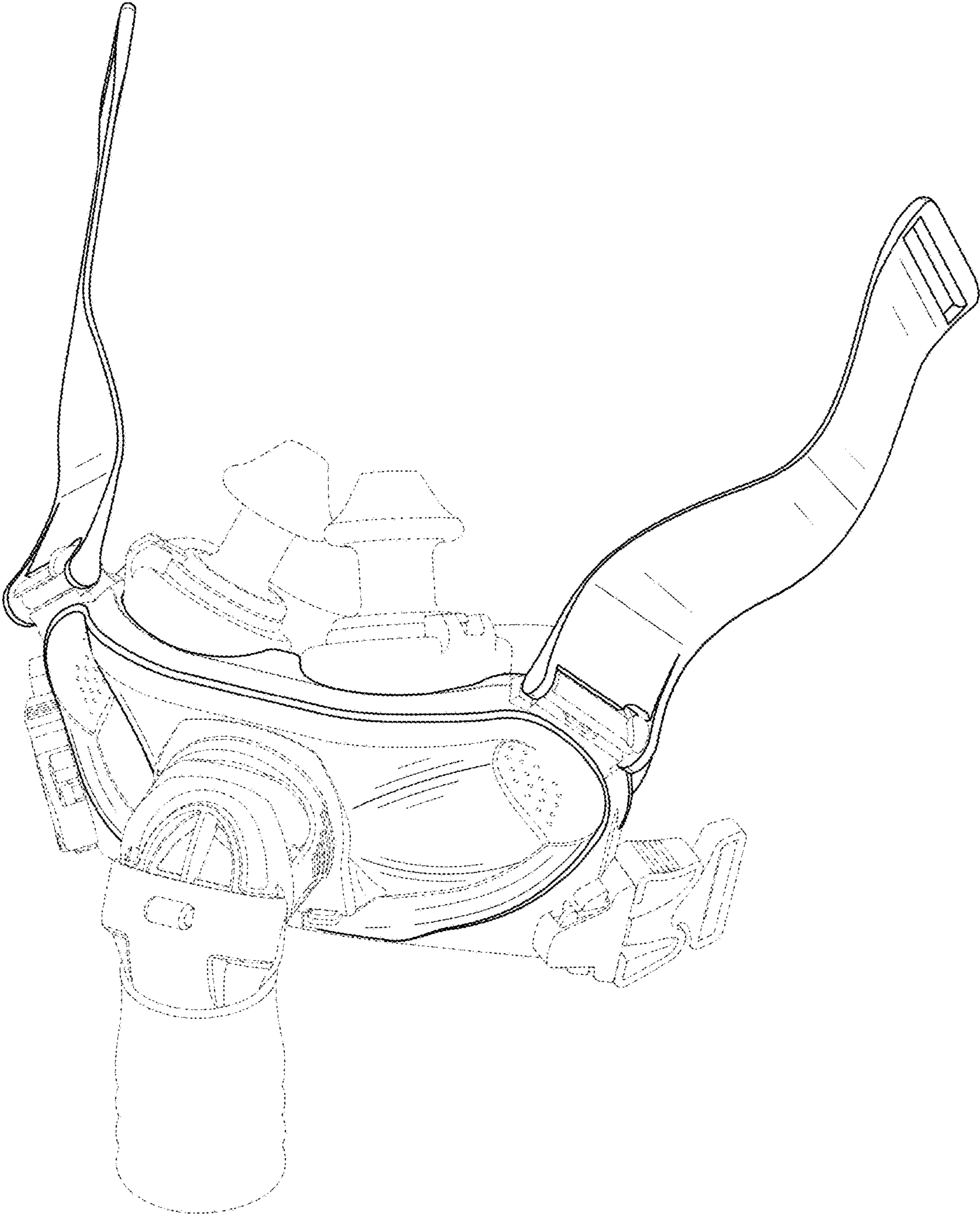

Fig. 1

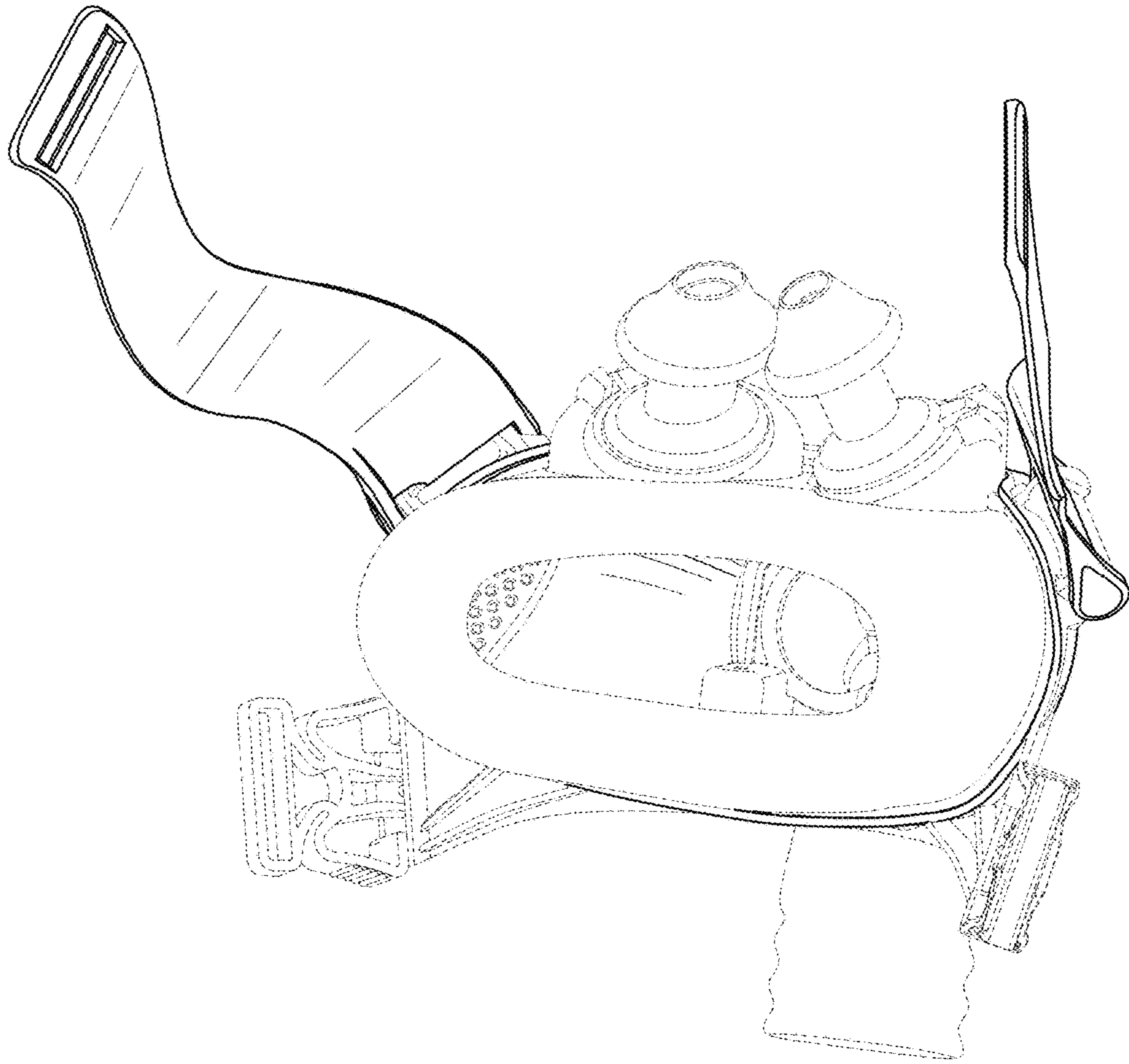

Fig. 2

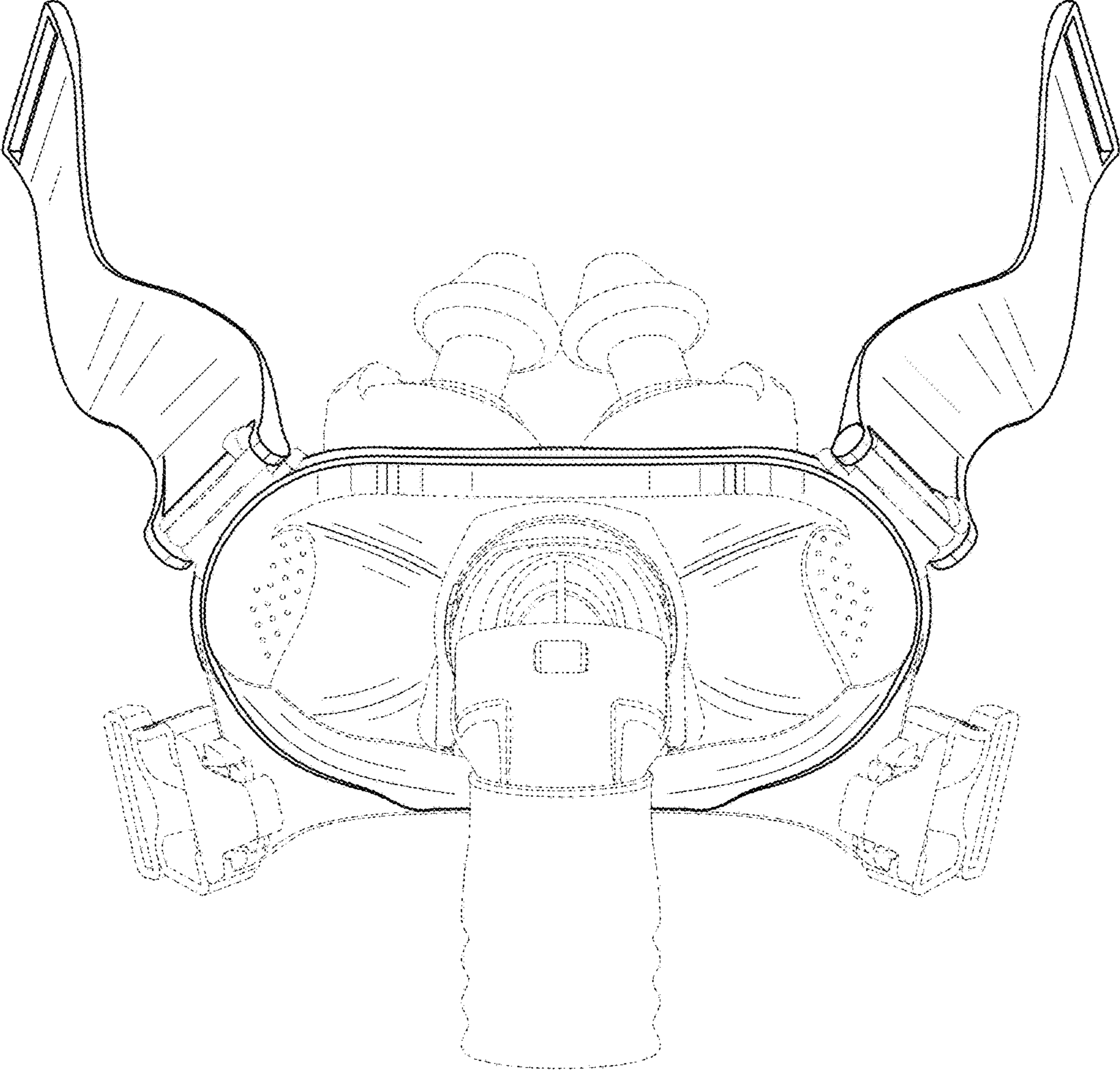

Fig. 3

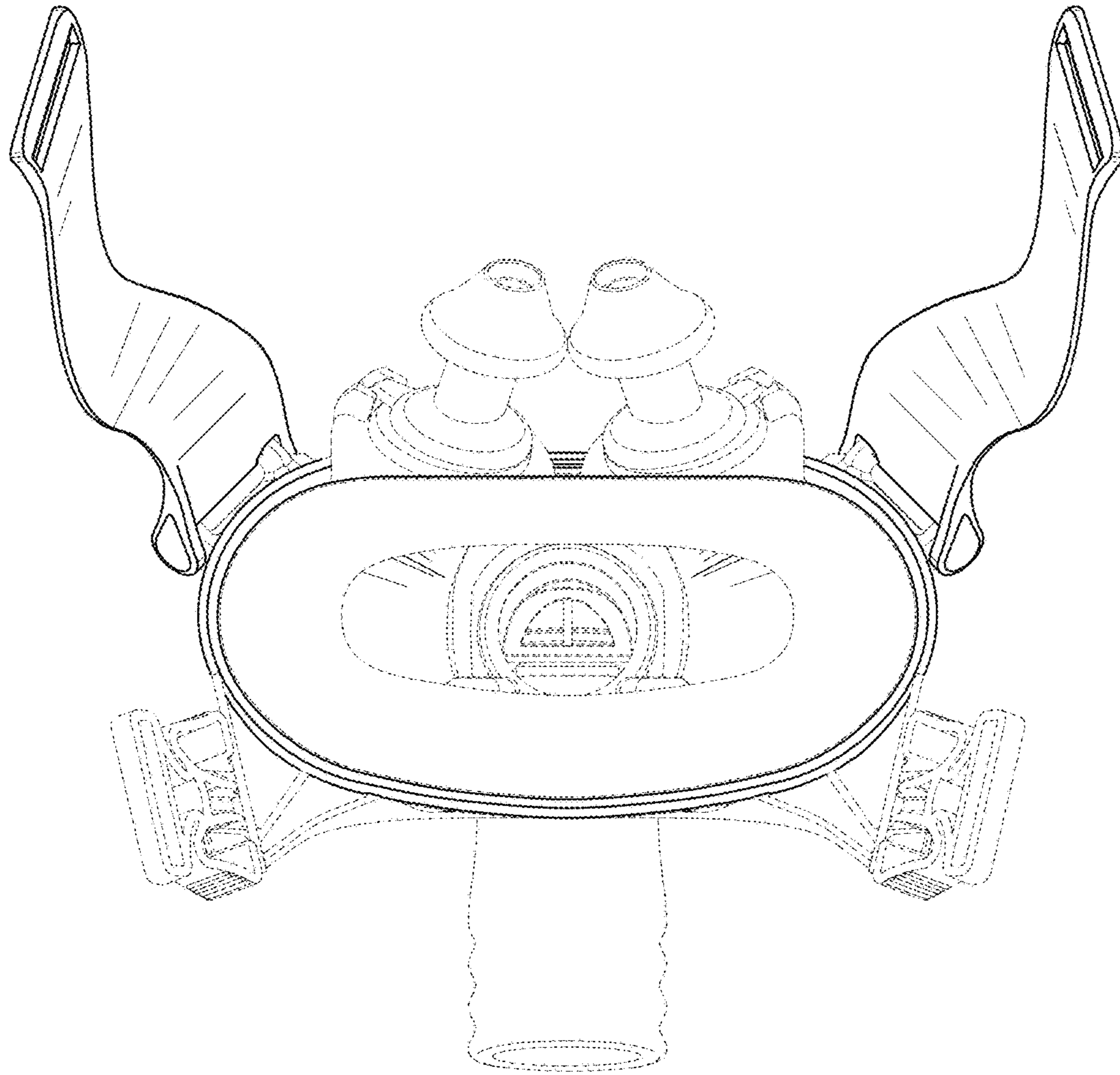

Fig. 4

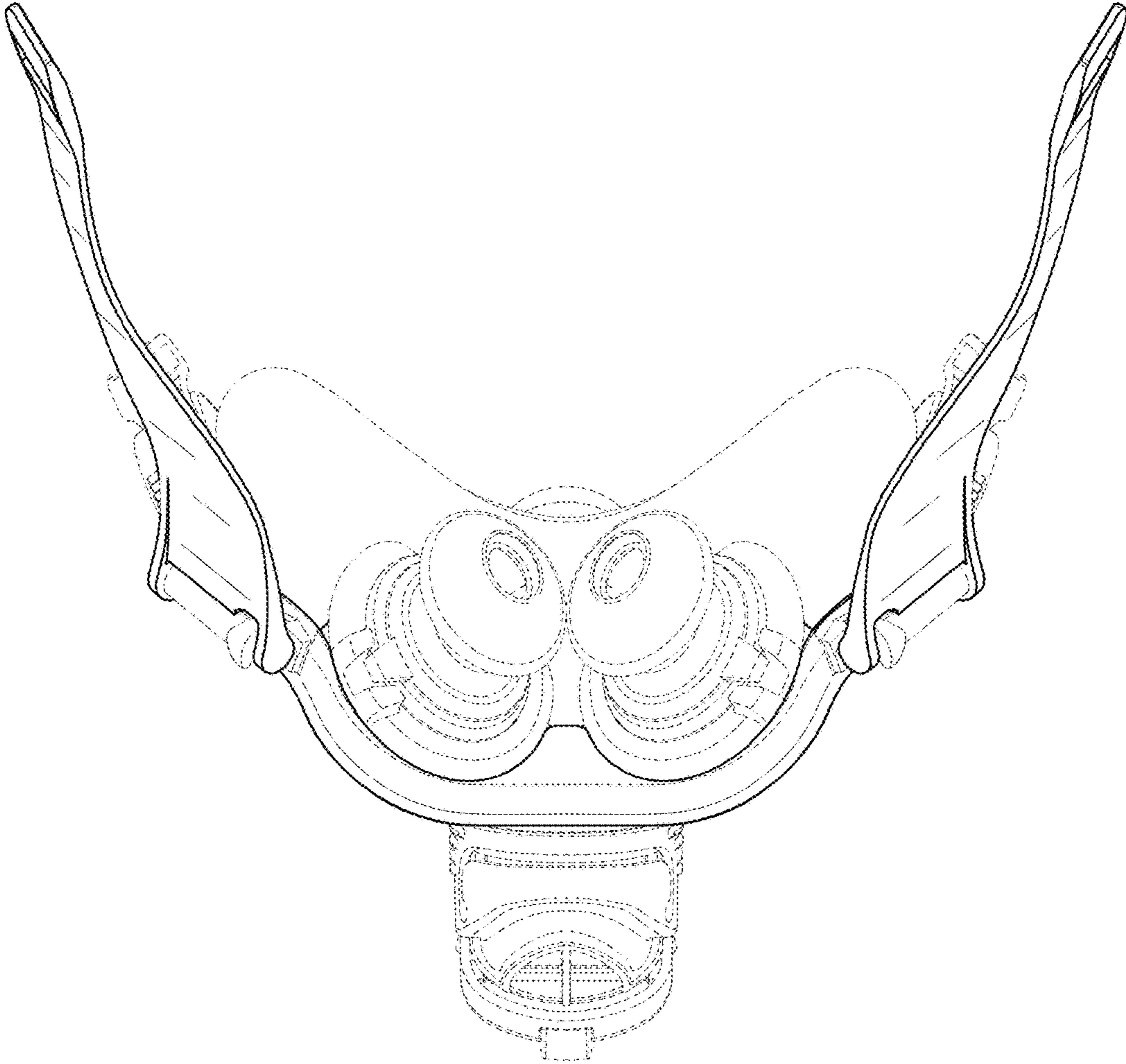

Fig. 5

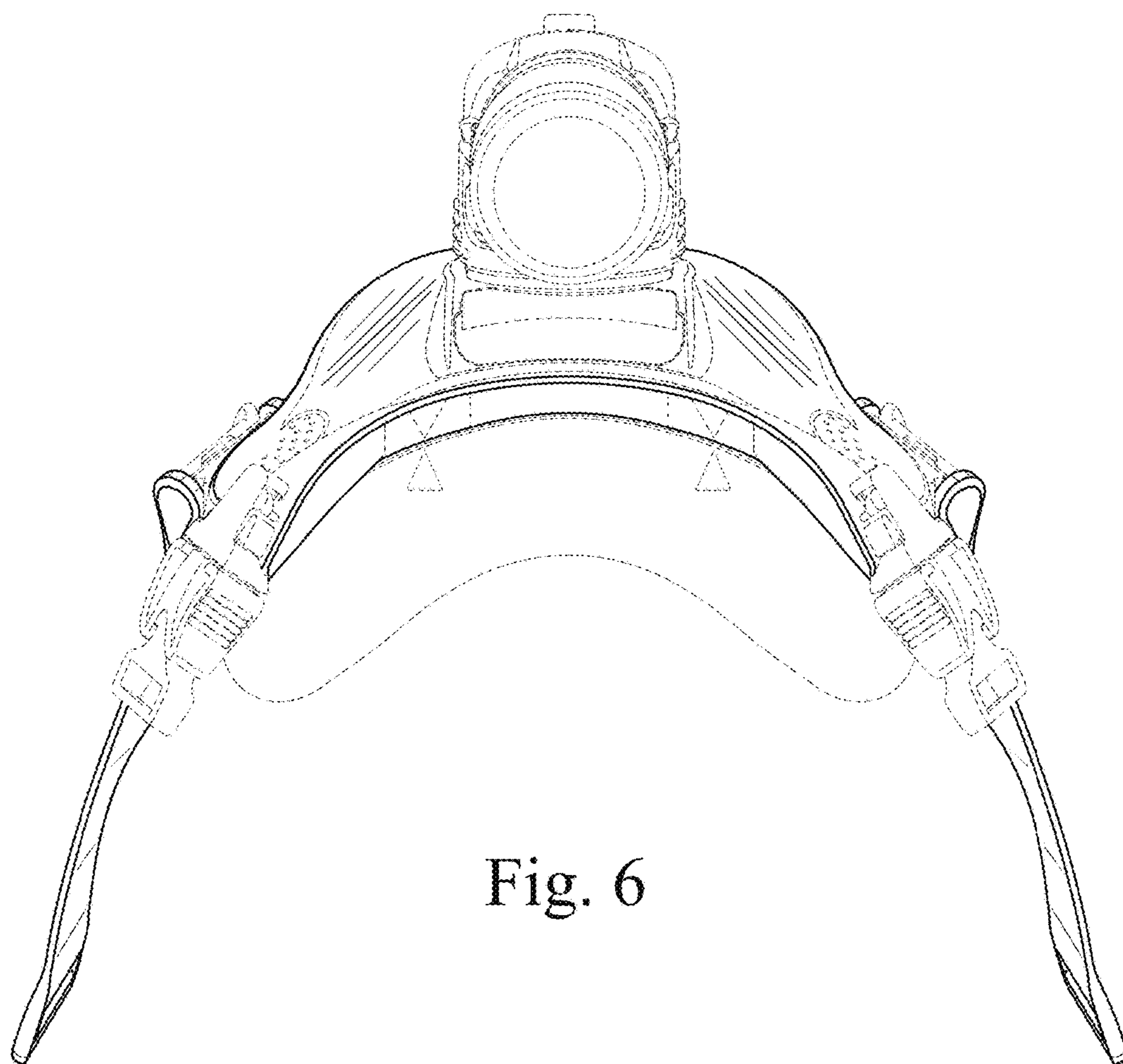

Fig. 6



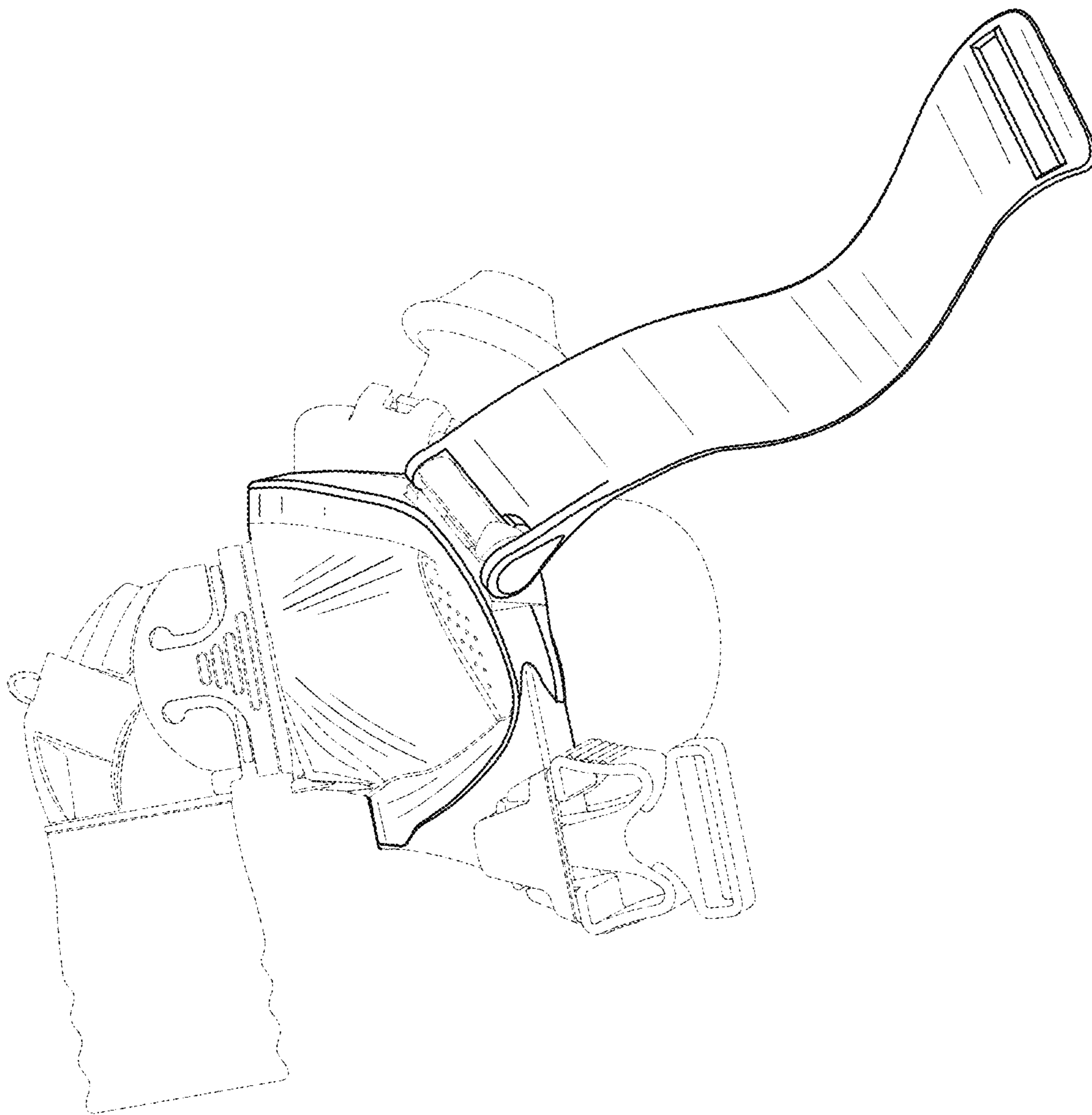

Fig. 7

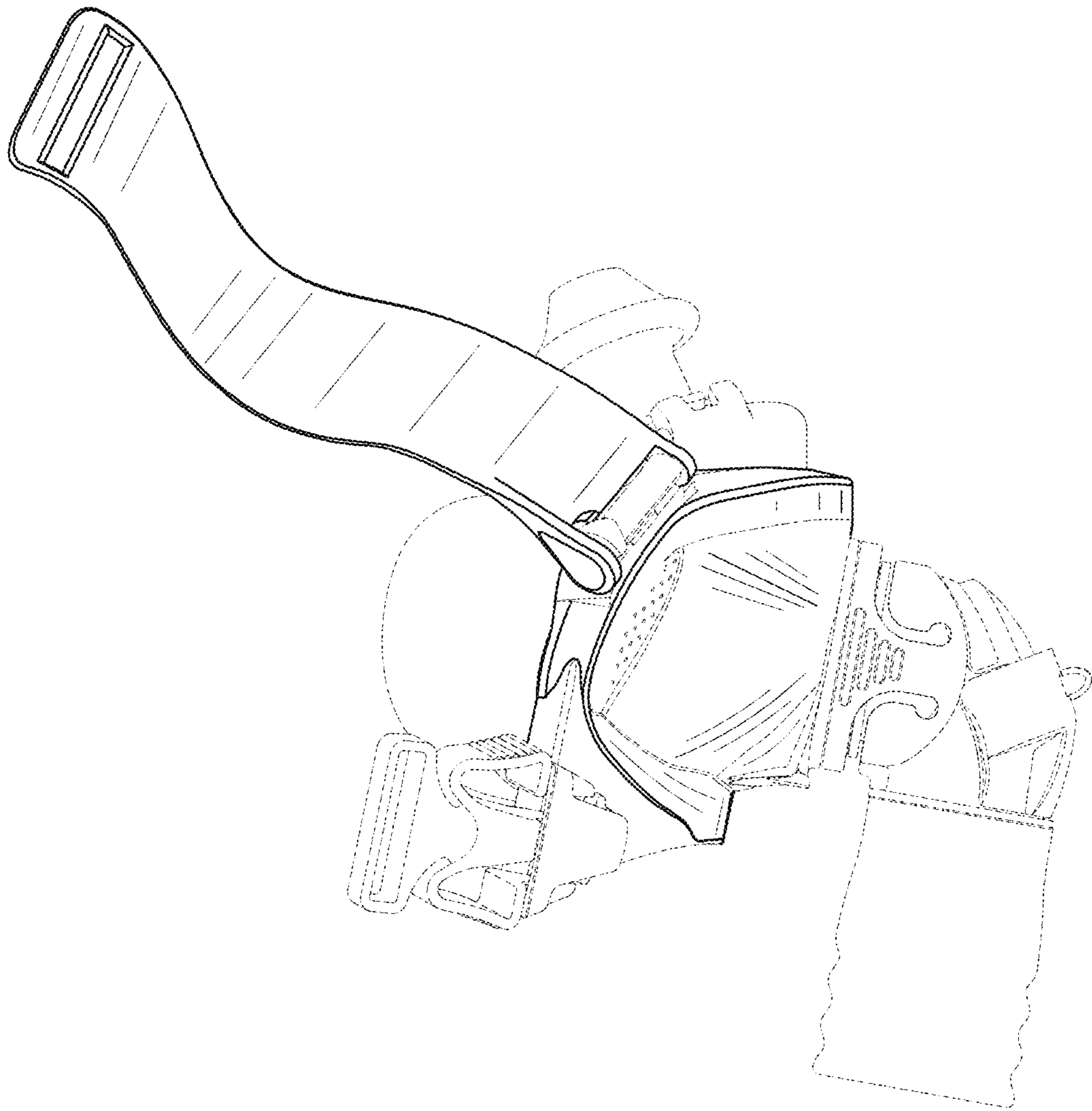

Fig. 8

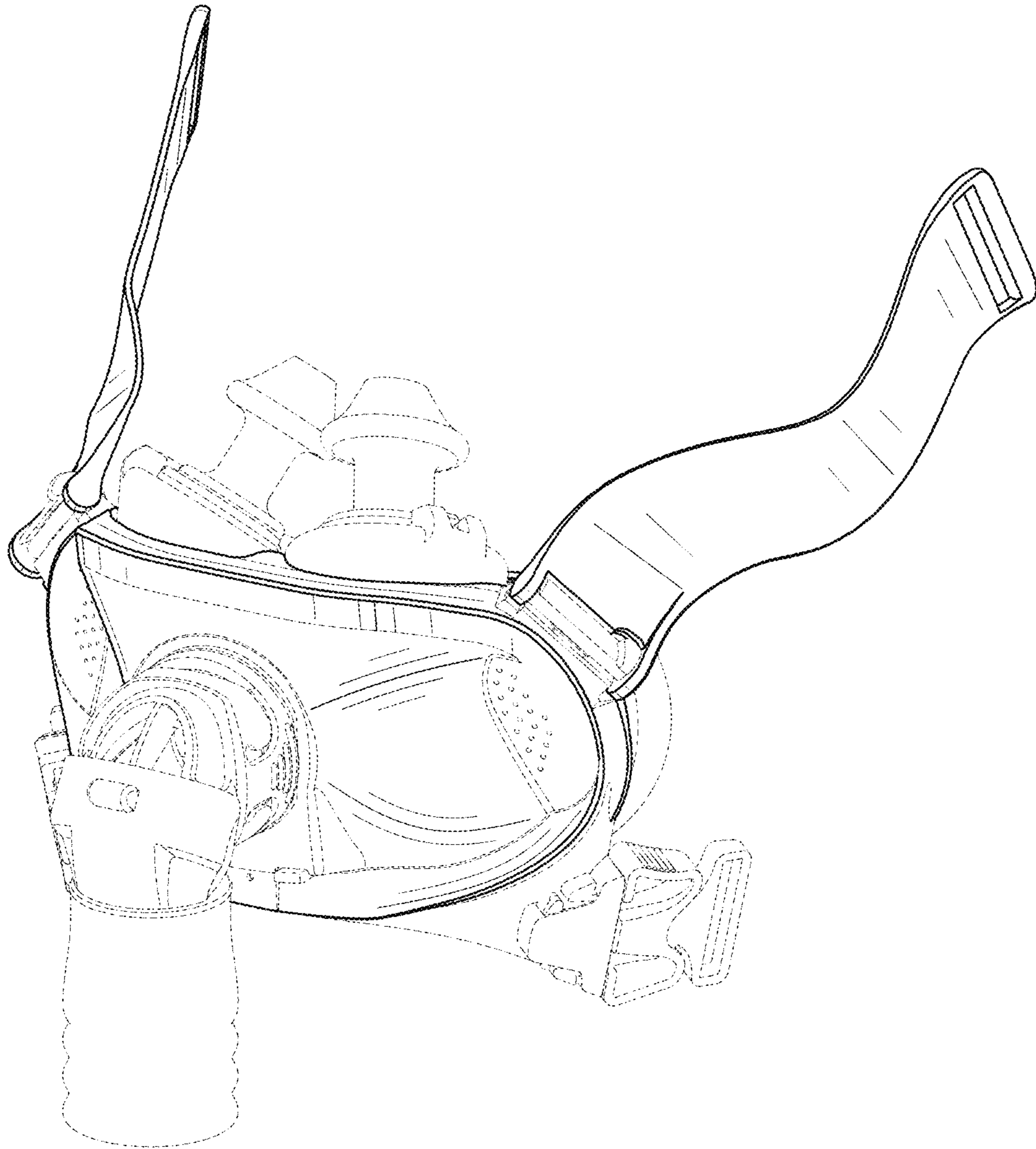

Fig. 9

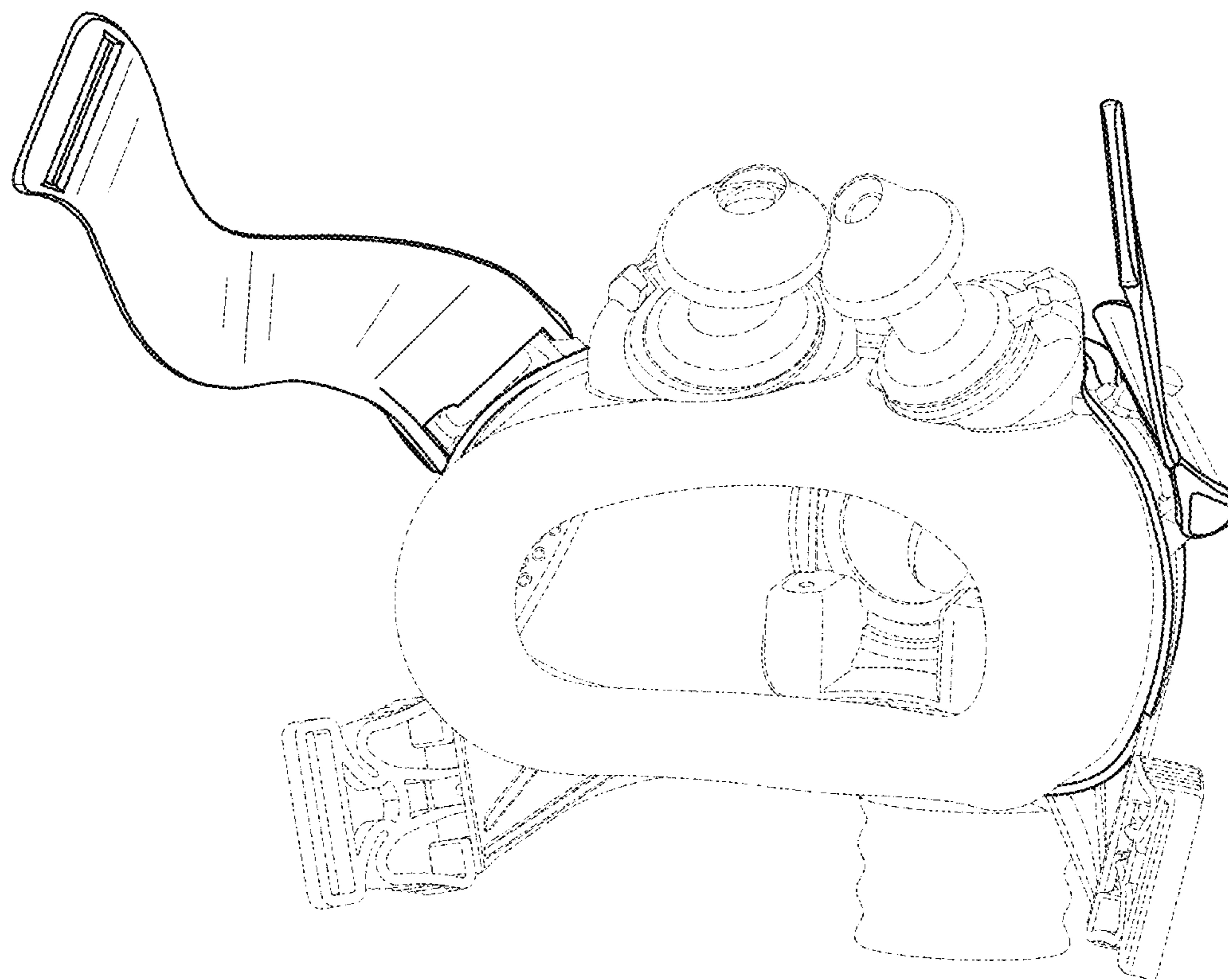

Fig. 10

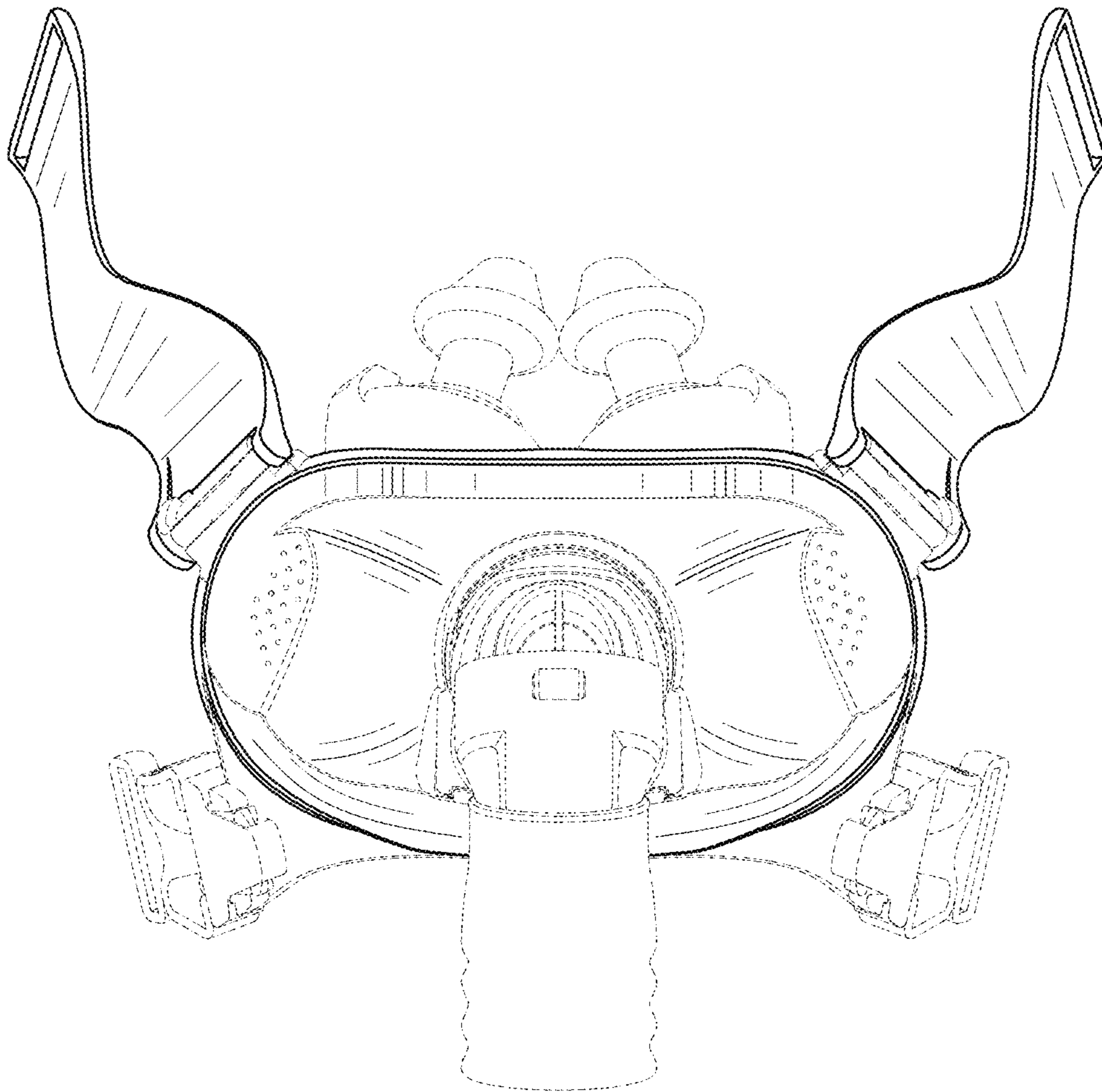

Fig. 11

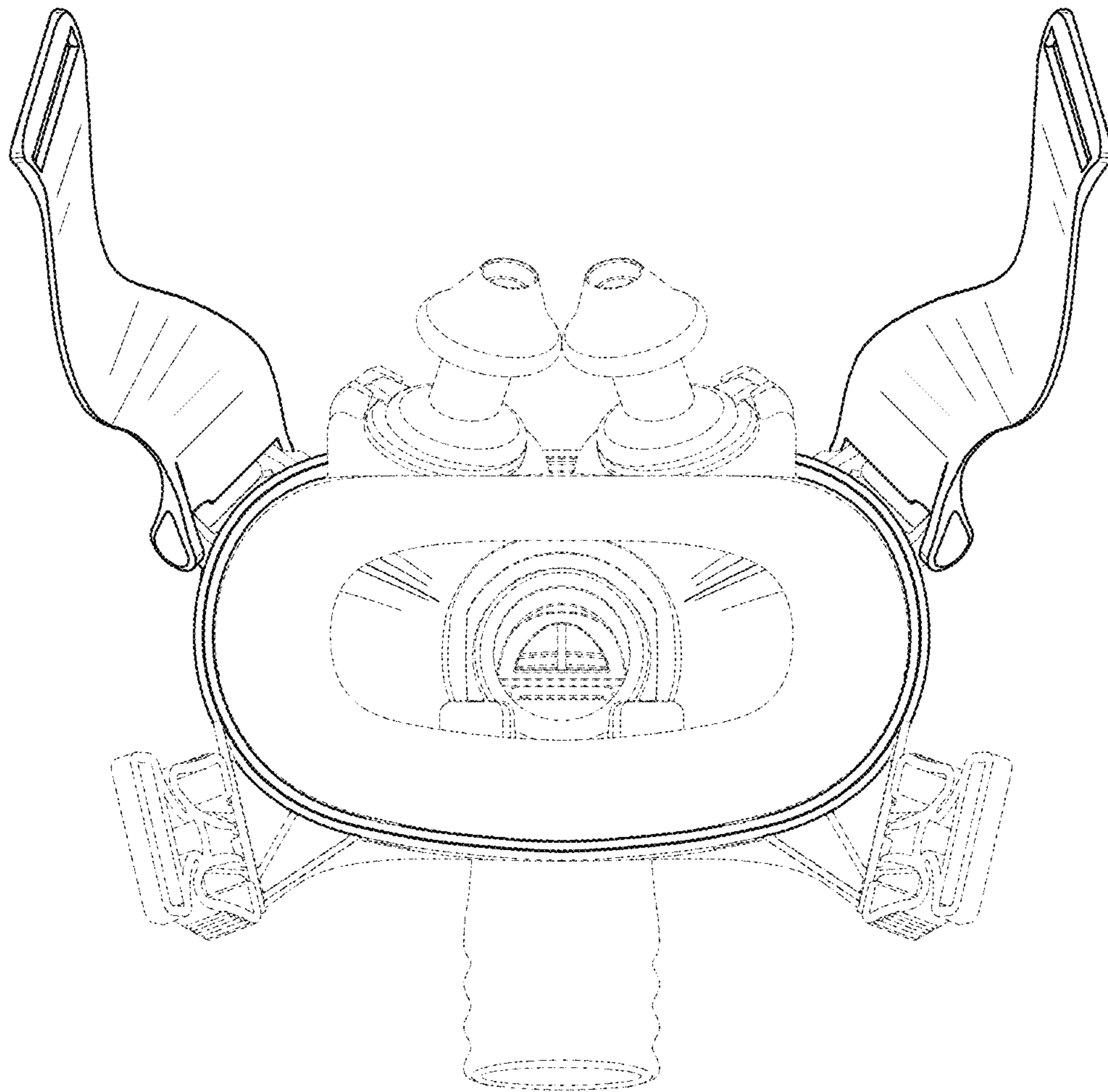

Fig. 12



Fig. 13

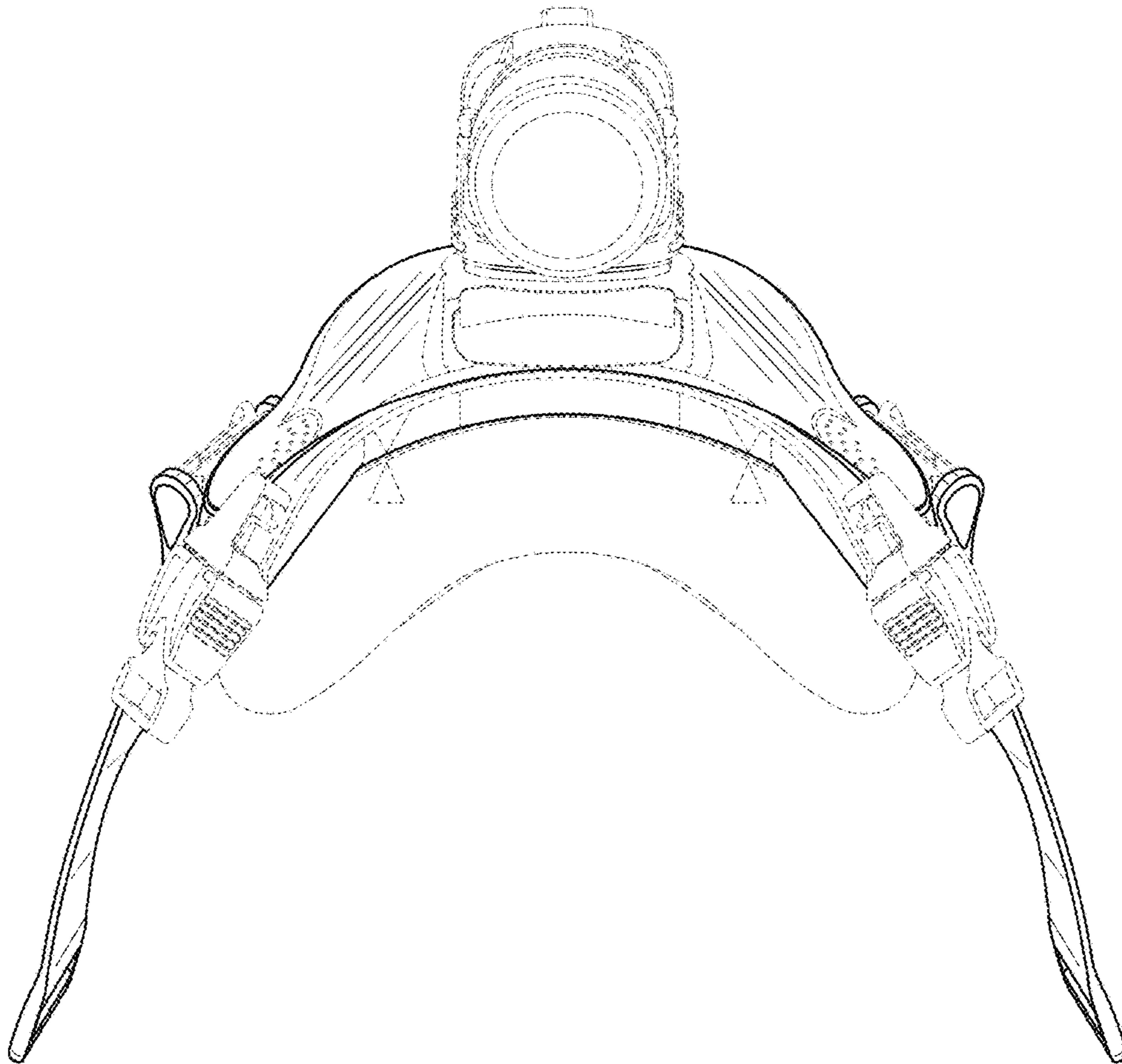

Fig. 14



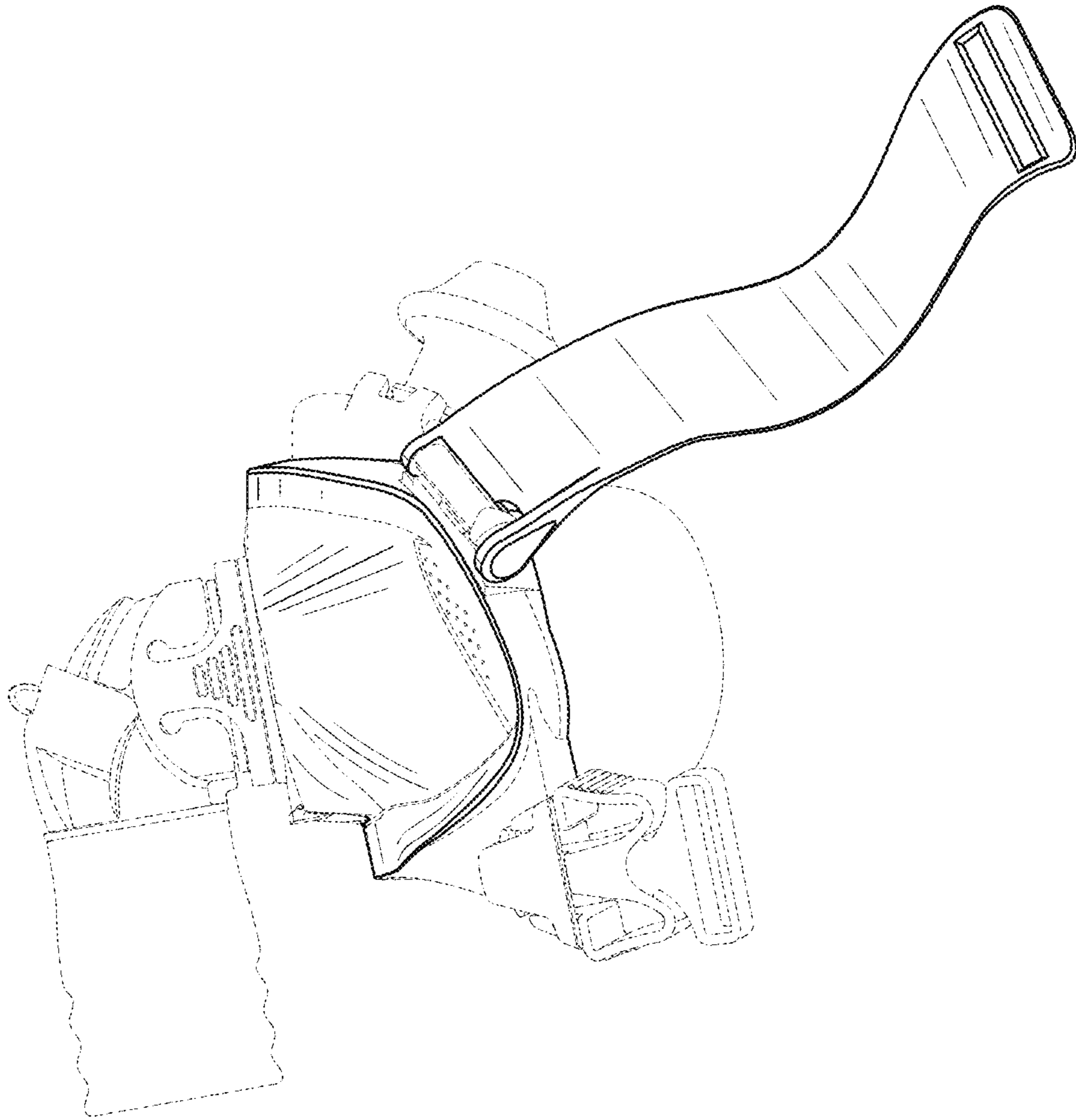

Fig. 15

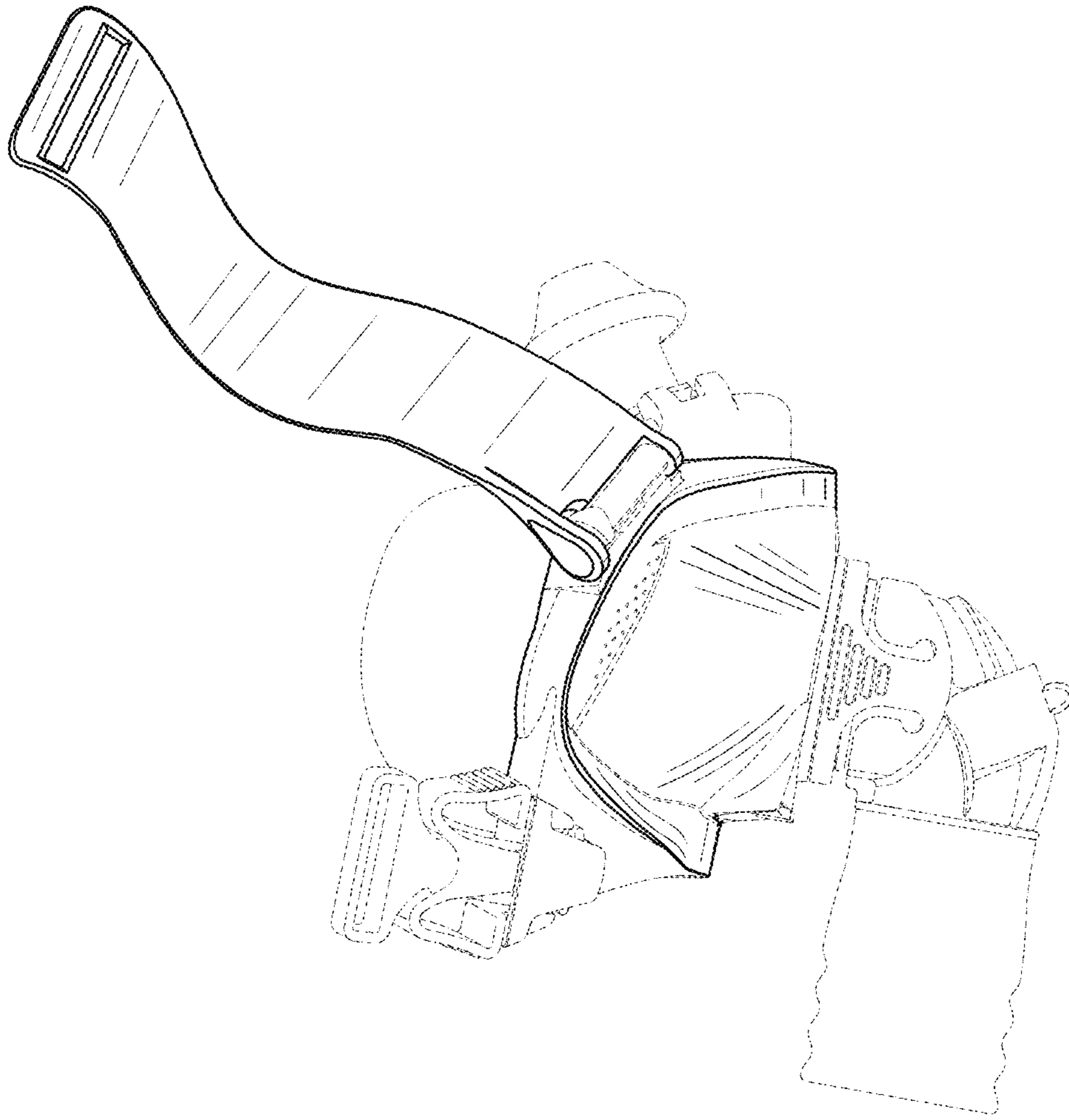

Fig. 16

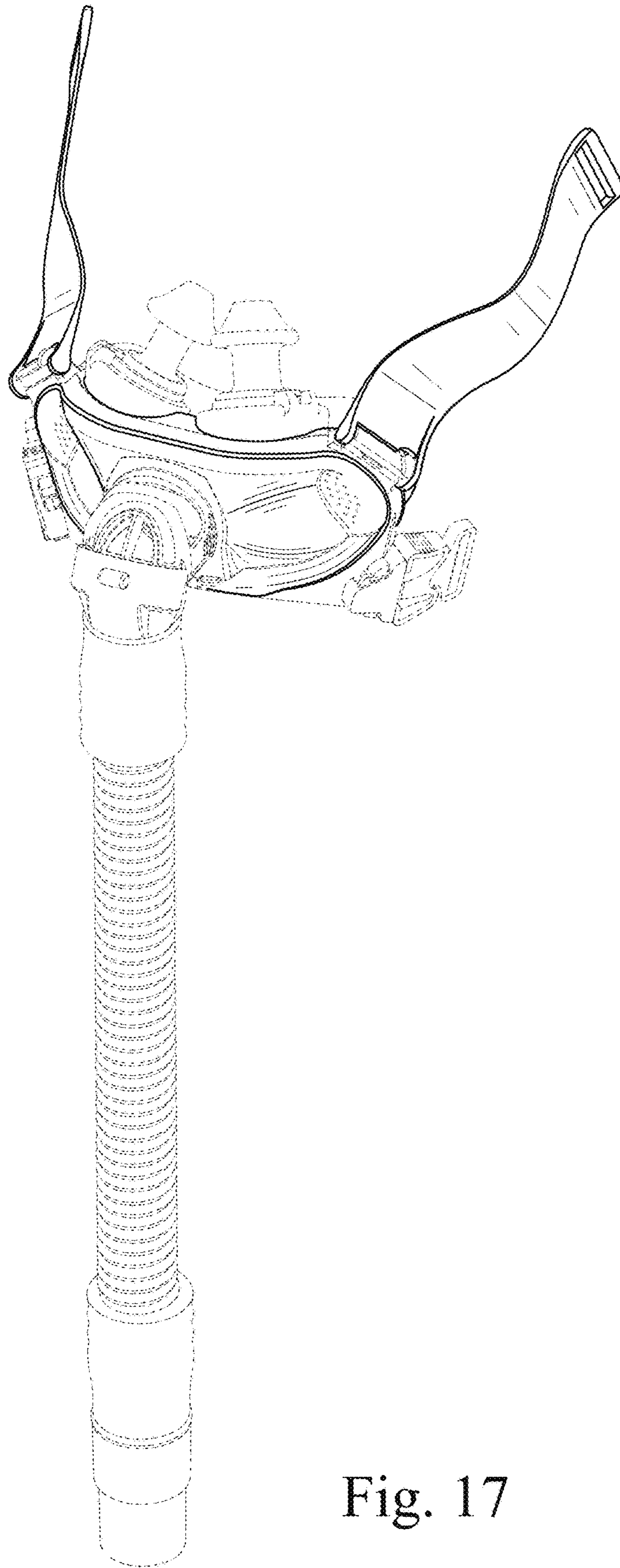

Fig. 17

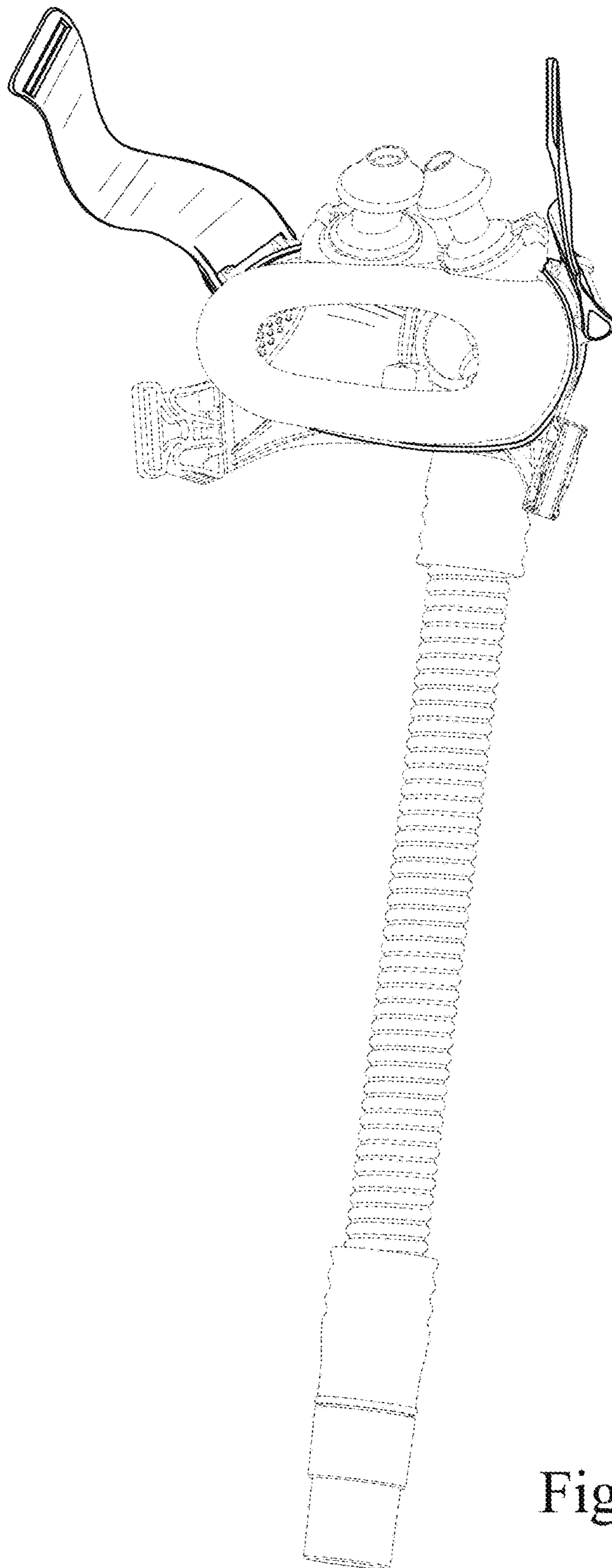

Fig. 18

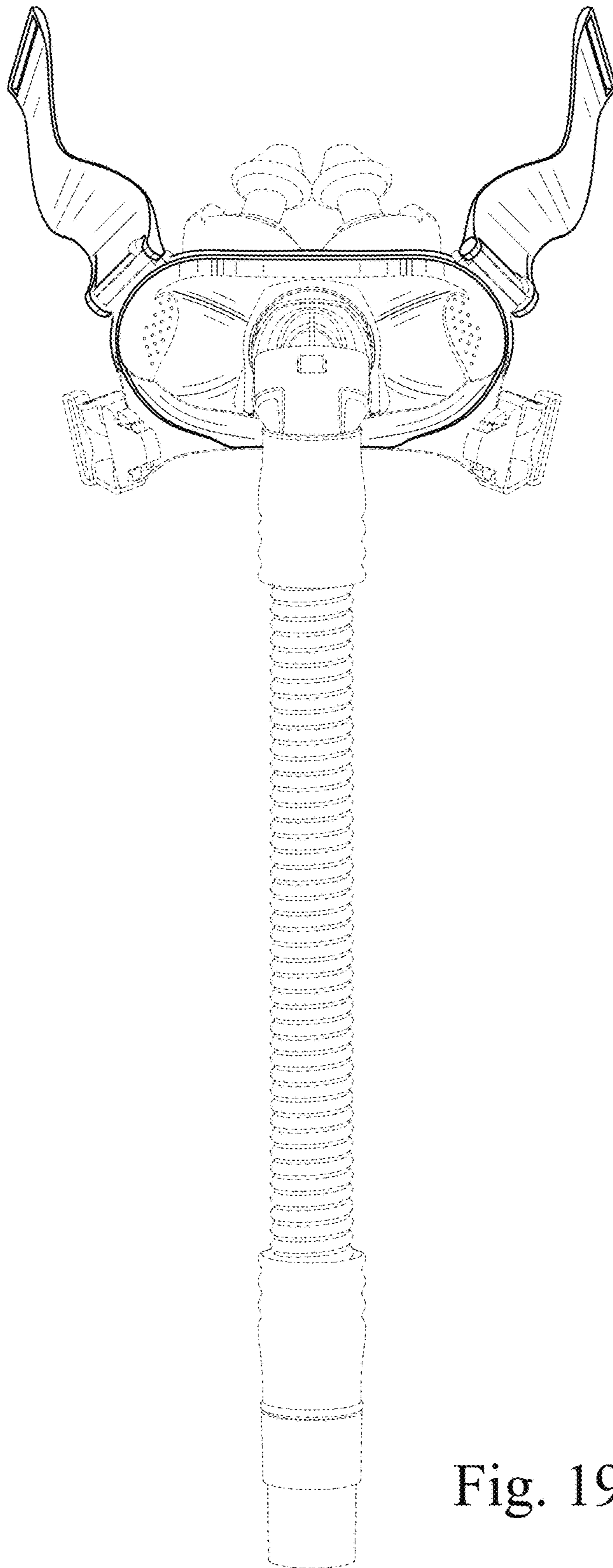

Fig. 19

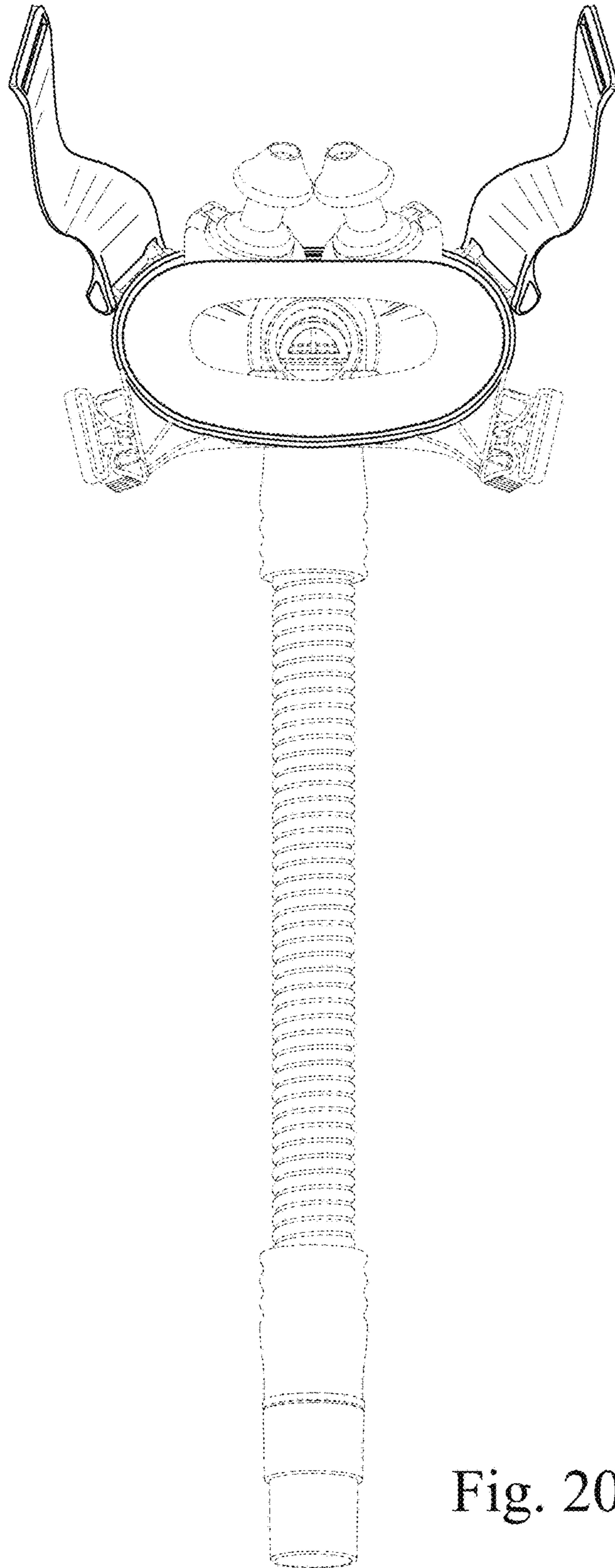

Fig. 20

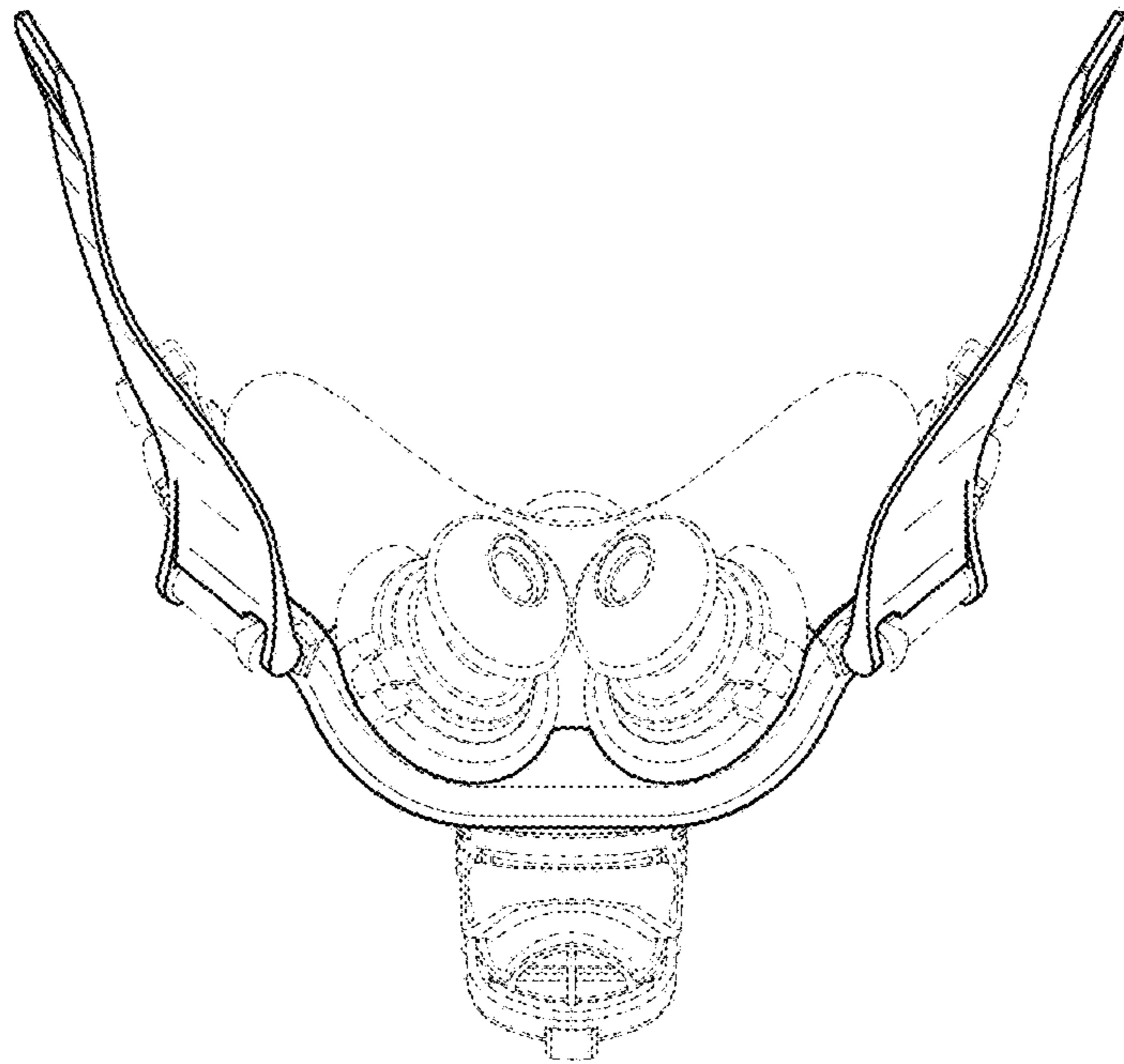

Fig. 21

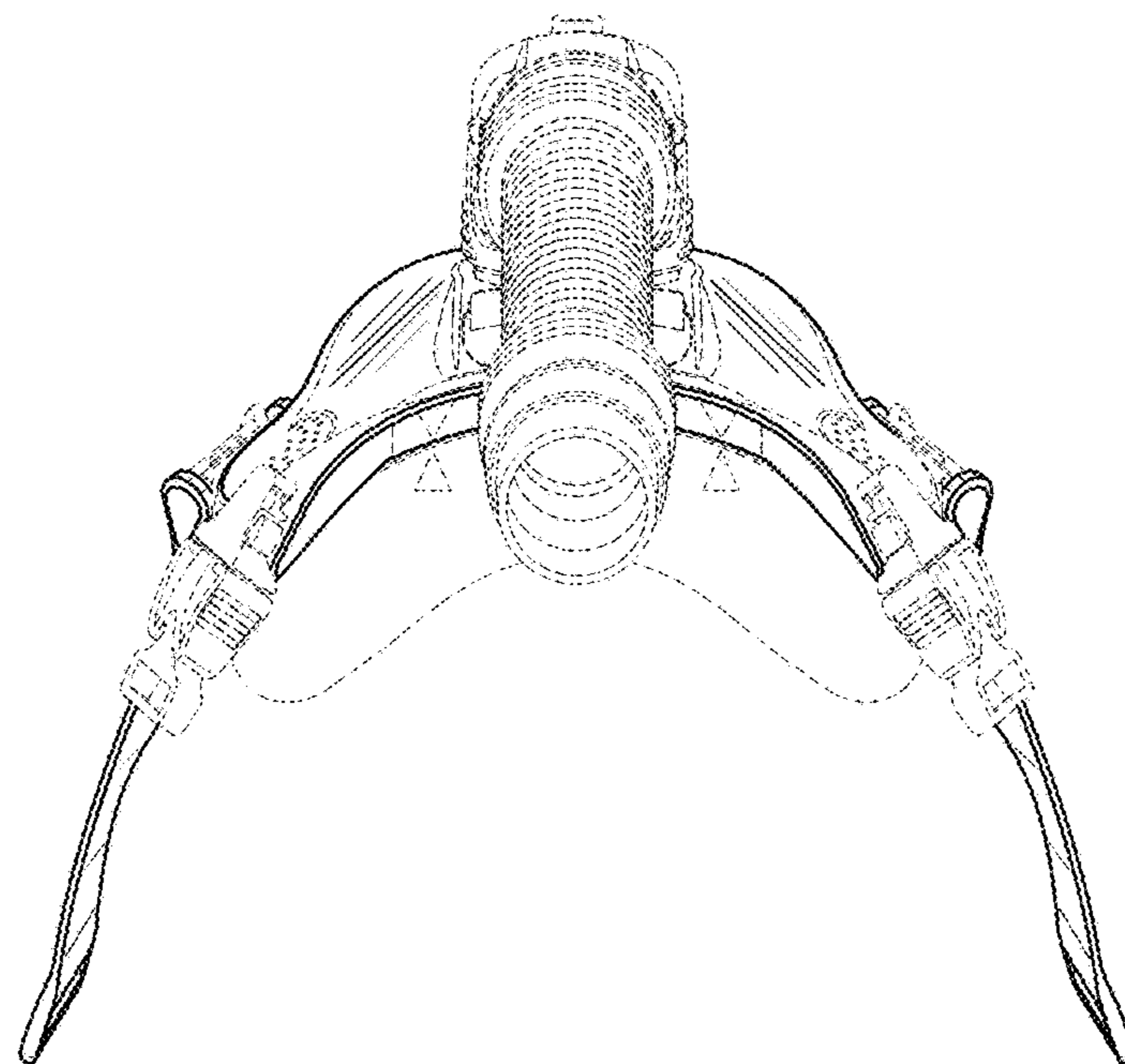

Fig. 22

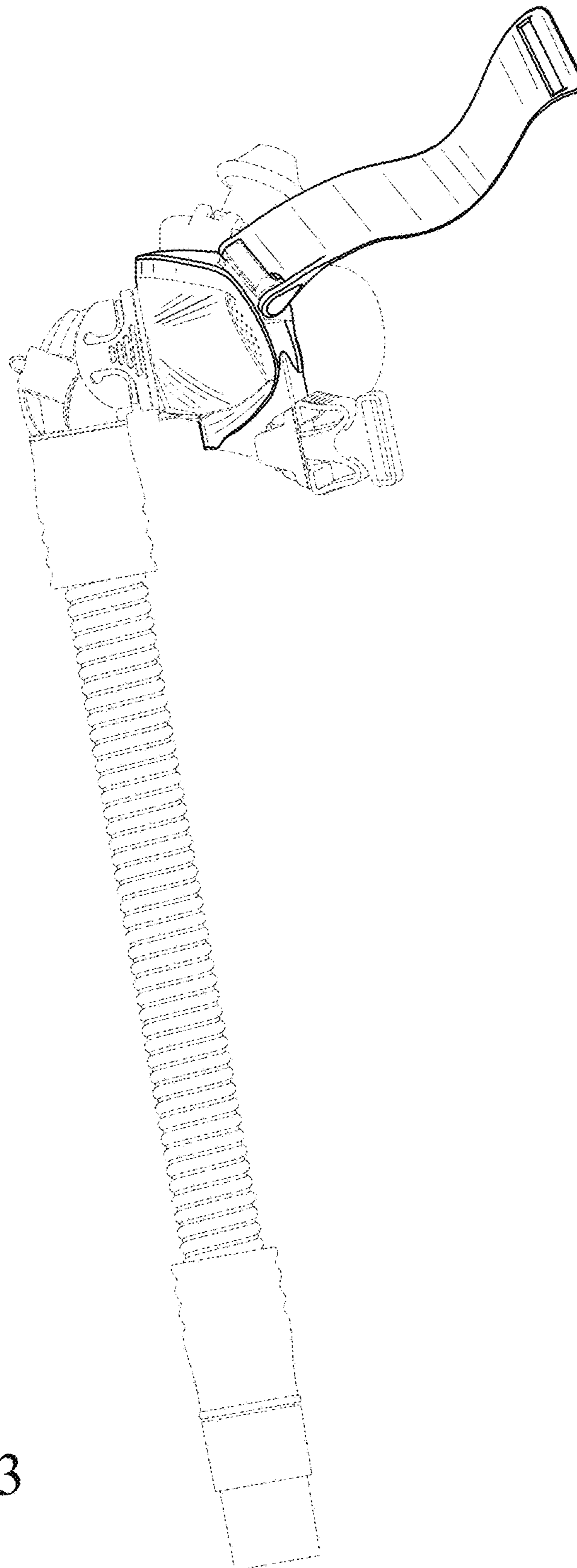

Fig. 23



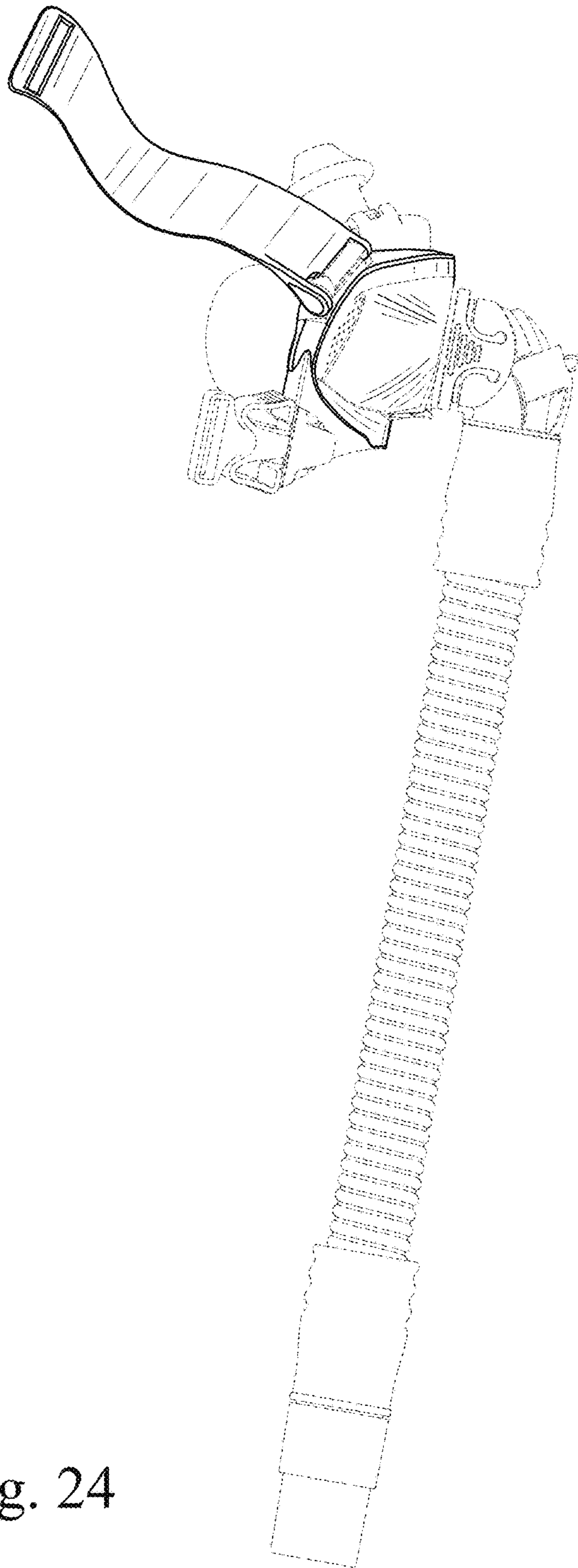

Fig. 24

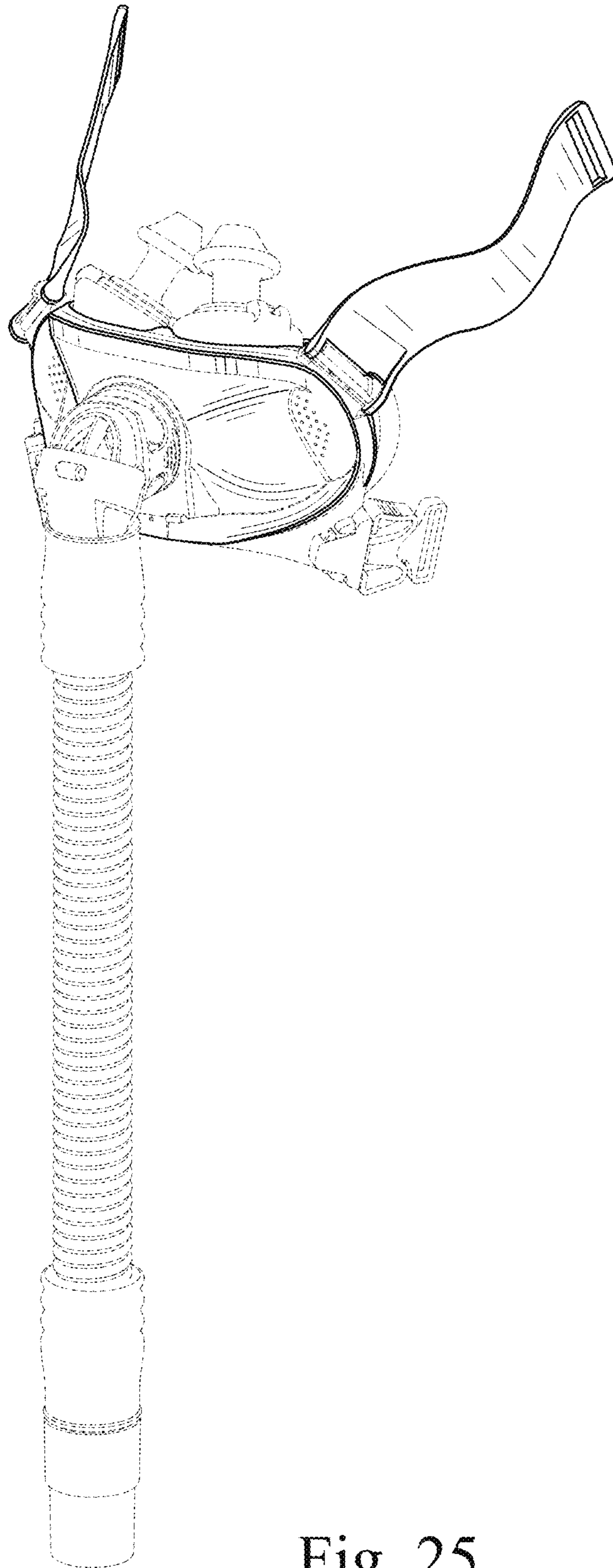

Fig. 25

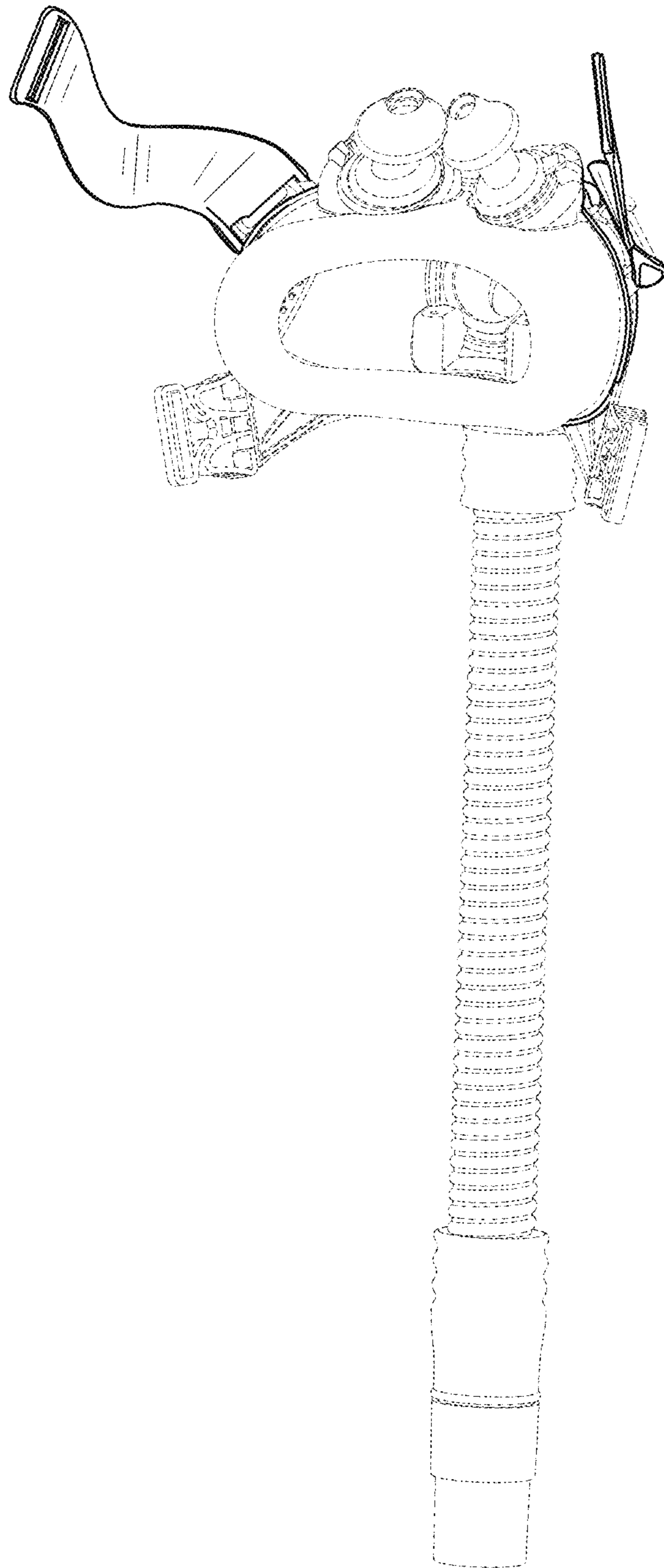

Fig. 26

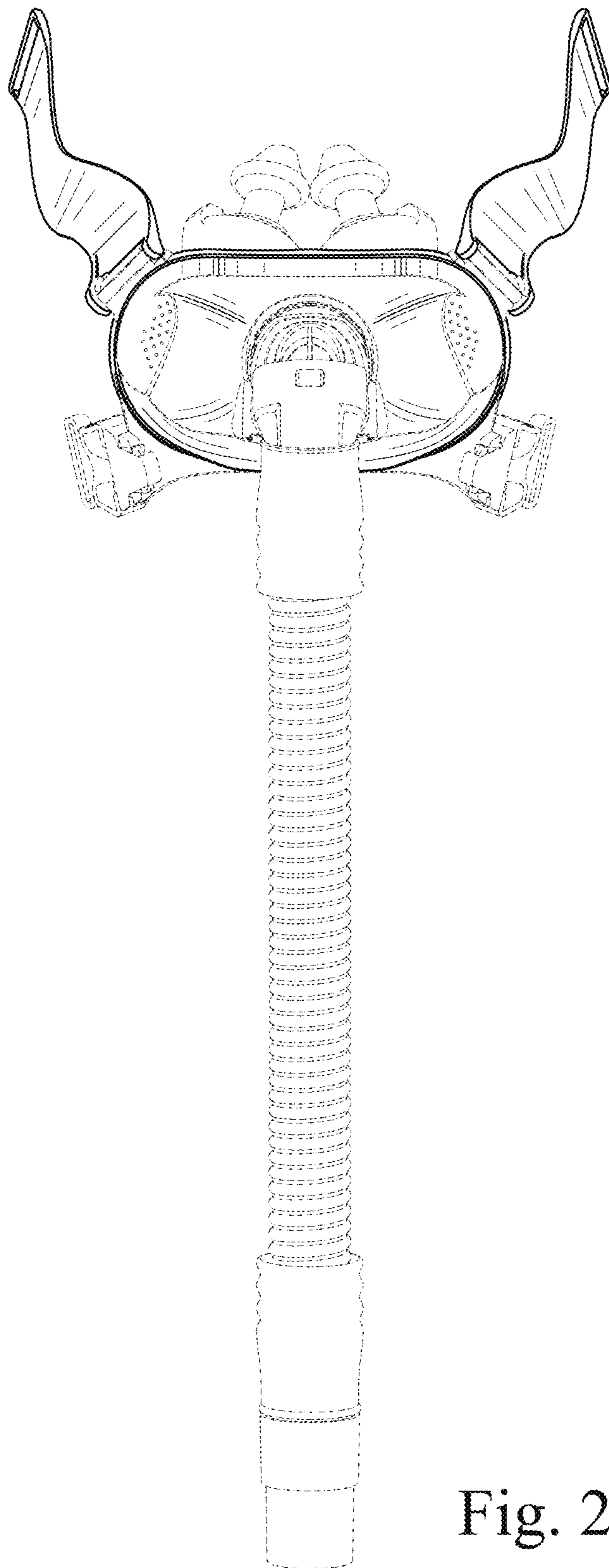

Fig. 27

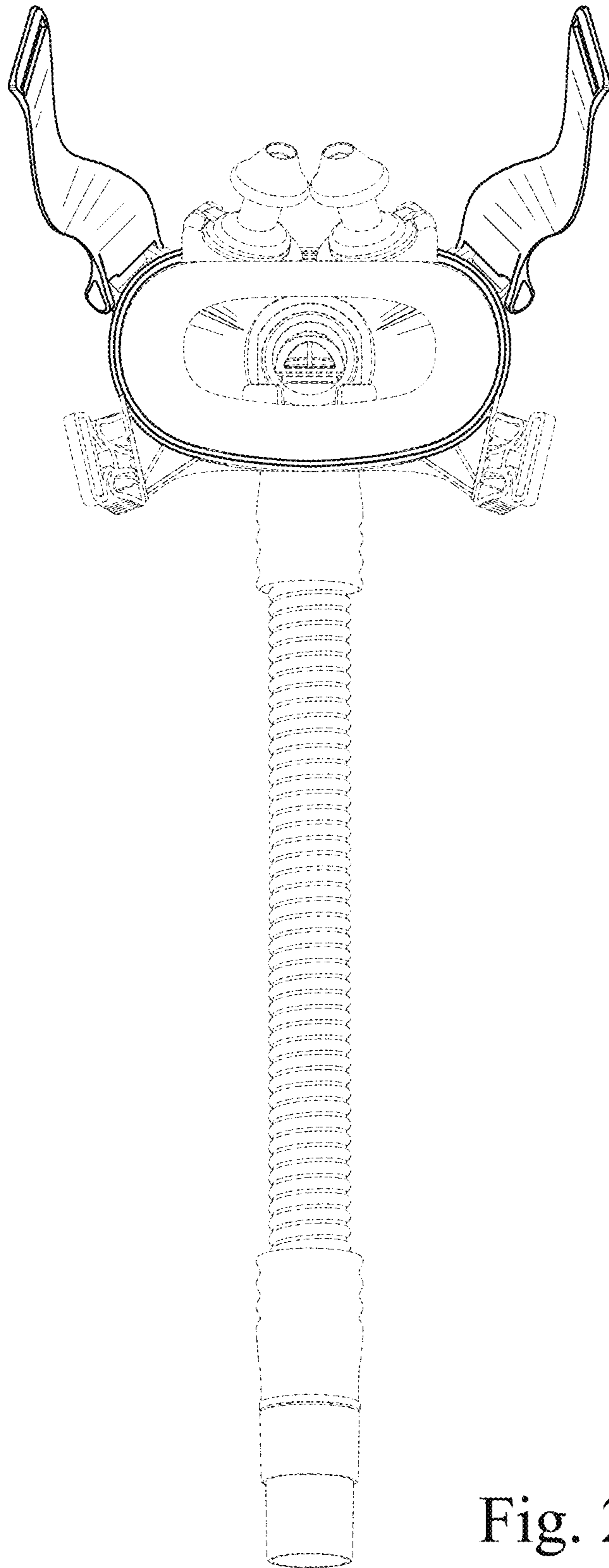

Fig. 28



Fig. 29

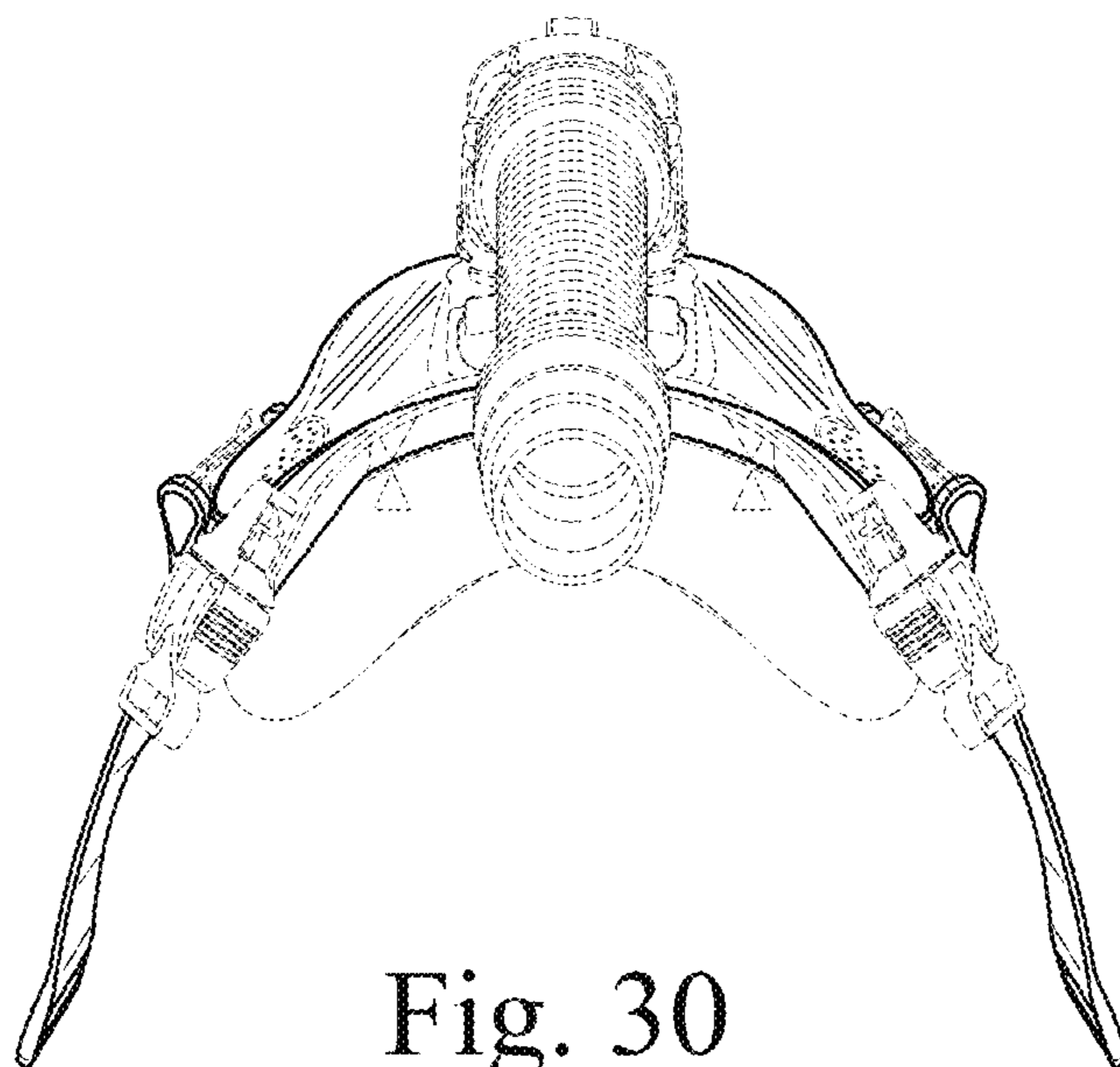

Fig. 30

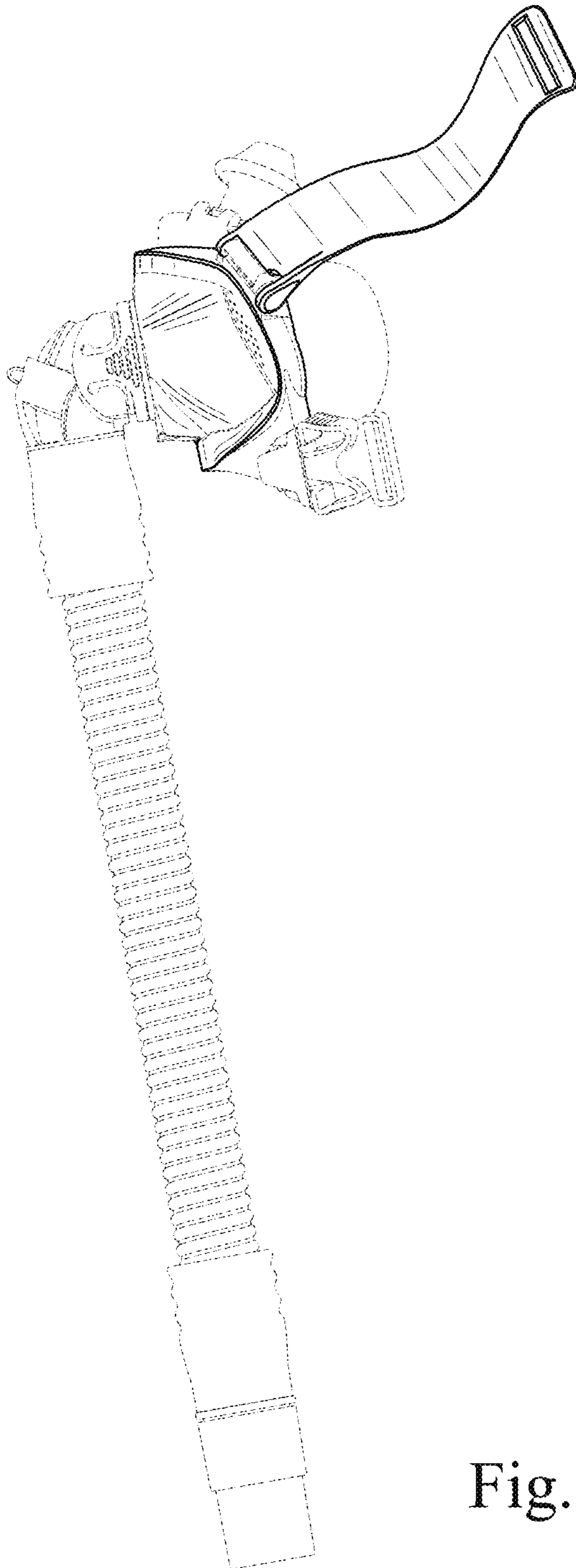

Fig. 31

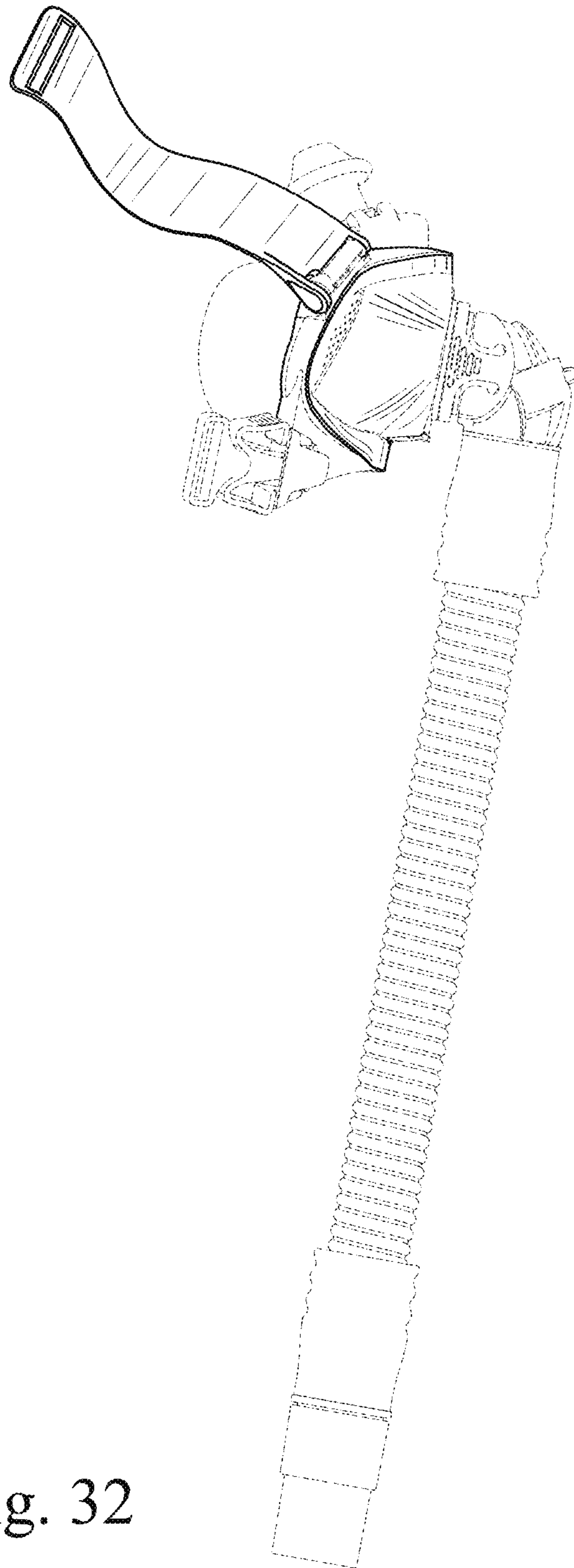

Fig. 32