



US00D820422S

(12) **United States Design Patent**
Kim et al.

(10) **Patent No.:** **US D820,422 S**
(45) **Date of Patent:** **** Jun. 12, 2018**

(54) **AIR PURIFIER WITH HUMIDIFIER**

(71) Applicant: **LG ELECTRONICS INC.**, Seoul (KR)

(72) Inventors: **Joosang Kim**, Seoul (KR); **Sungkyong Han**, Seoul (KR); **Yoojeung Han**, Seoul (KR); **Sehwan Bae**, Seoul (KR)

(73) Assignee: **LG ELECTRONICS INC.**, Seoul (KR)

(**) Term: **15 Years**

(21) Appl. No.: **29/576,883**

(22) Filed: **Sep. 7, 2016**

(30) **Foreign Application Priority Data**

Mar. 24, 2016 (KR) 30-2016-0013863

(51) **LOC (11) Cl.** **23-04**

(52) **U.S. Cl.**
USPC **D23/364**

(58) **Field of Classification Search**
USPC D23/355-366, 352, 369, 332, 333, 335, D23/336, 342, 351; 422/120, 122; 55/356, 473, 504; 96/97; 261/DIG. 17, 261/DIG. 65, DIG. 88, DIG. 31
CPC .. A61L 9/16; A61L 9/22; B01D 47/00; B01D 47/027; B01D 2221/02; B01D 2259/4508; B03C 3/155; F24F 13/20; F24F 13/222
See application file for complete search history.

(56) **References Cited**

U.S. PATENT DOCUMENTS

D513,797 S * 1/2006 Wang D23/356
D581,035 S * 11/2008 Conway D23/366

D648,016 S * 11/2011 Choi D23/364
D675,304 S * 1/2013 Valentino D23/366
D678,493 S * 3/2013 Lacotta D23/355
D681,182 S * 4/2013 Tomas Vilarasa D23/366
D682,406 S * 5/2013 Yeom D23/356
D683,439 S * 5/2013 Choi D23/364
D689,998 S * 9/2013 Carbone D23/366
D713,517 S * 9/2014 Dodge D23/366
D714,923 S * 10/2014 Engelhard D23/364
D729,921 S * 5/2015 Poindexter D23/364
D768,834 S * 10/2016 Schuller D23/366

* cited by examiner

Primary Examiner — David Muller

(74) *Attorney, Agent, or Firm* — Dentons US LLP

(57) **CLAIM**

We claim the ornamental design for an air purifier with humidifier, as shown and described.

DESCRIPTION

FIG. 1 is a perspective view of an air purifier with humidifier showing the new design;
FIG. 2 is a front elevation view thereof;
FIG. 3 is a rear elevation view thereof;
FIG. 4 is a left-side elevation view thereof;
FIG. 5 is a right-side elevation view thereof;
FIG. 6 is a top plan view thereof;
FIG. 7 is a bottom plan view thereof; and,
FIG. 8 is a top plan view thereof, in a use condition.
The broken lines represent unclaimed portions of the air purifier with humidifier and form no part of the claimed design.

1 Claim, 8 Drawing Sheets

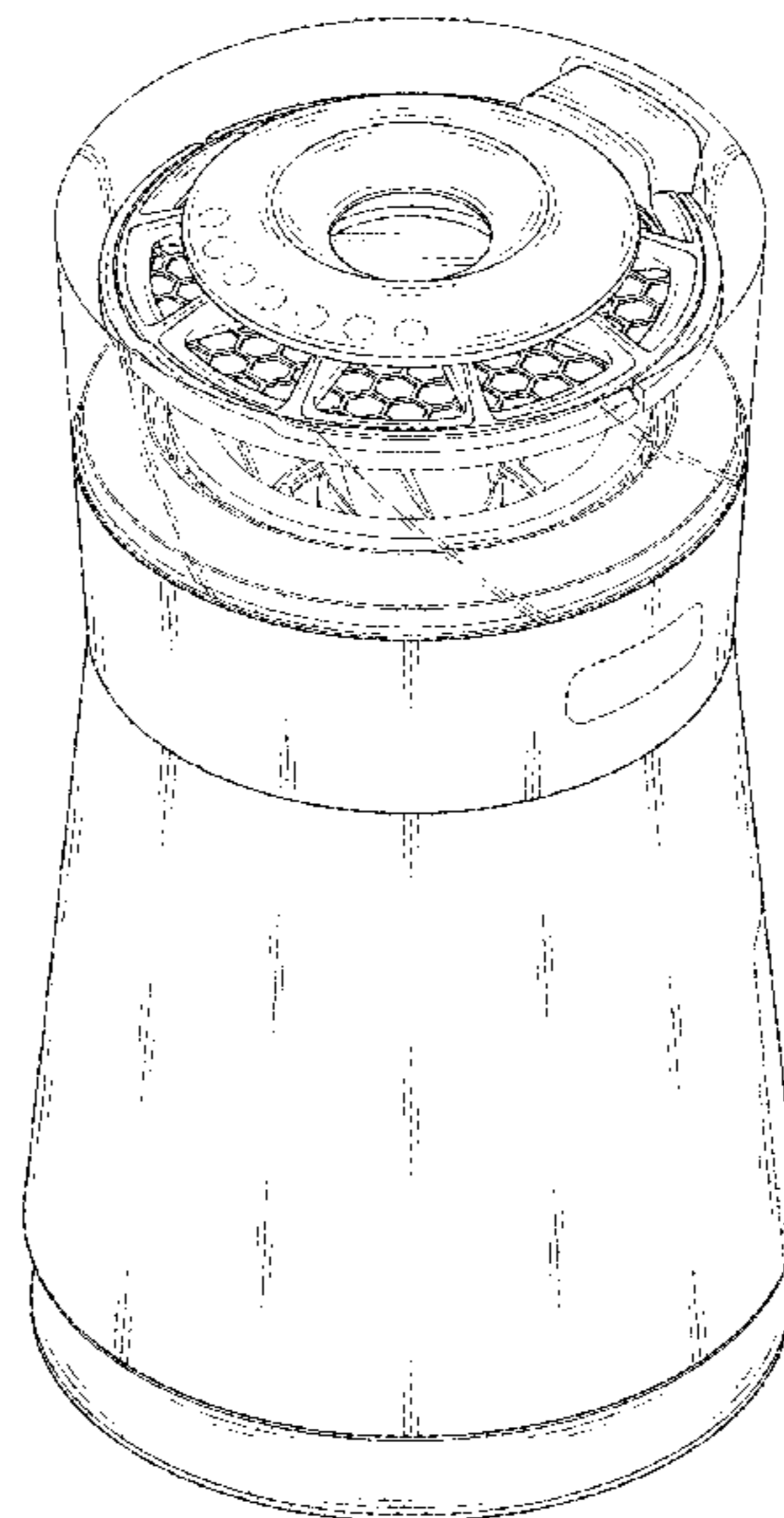

FIG. 1

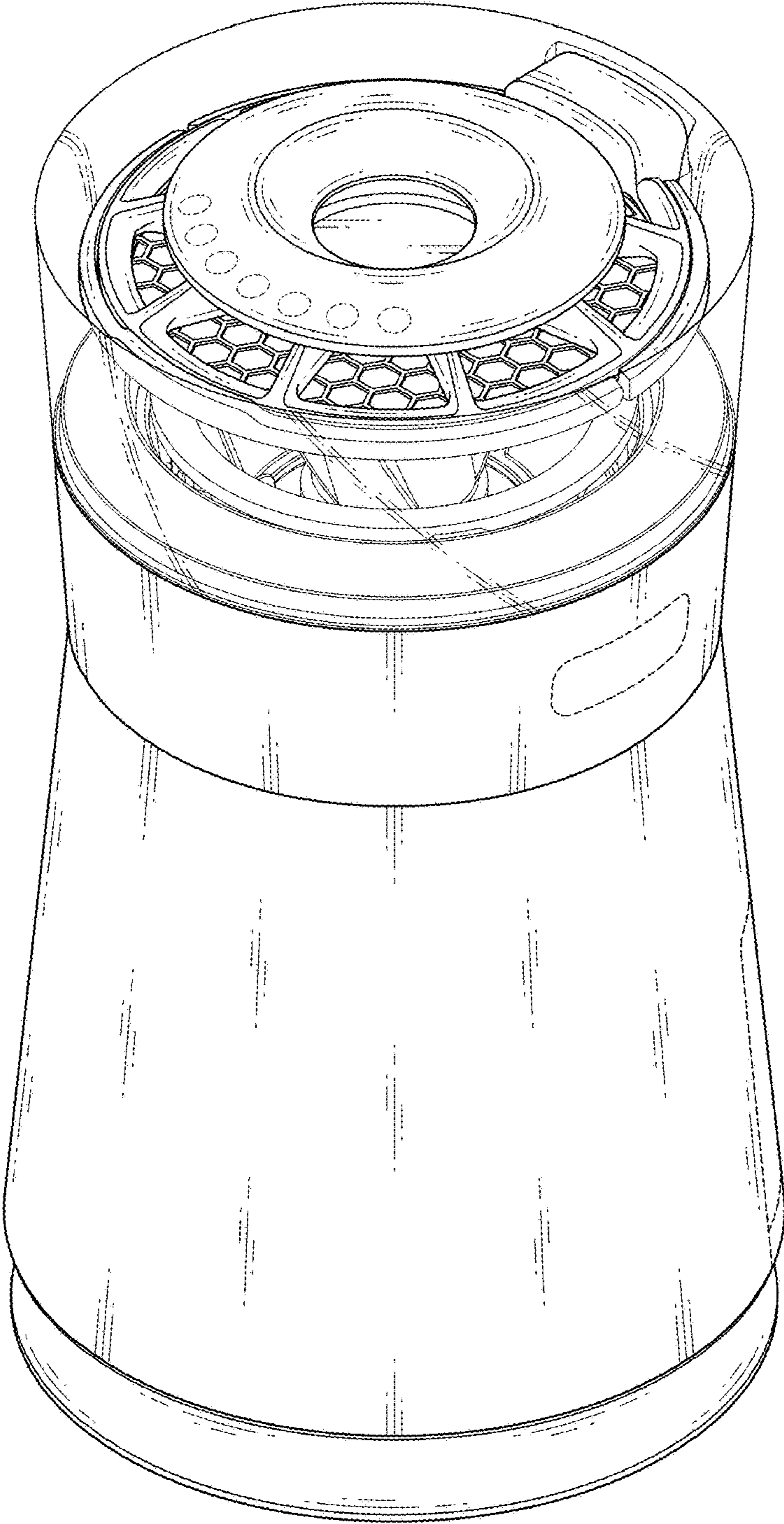

FIG. 2

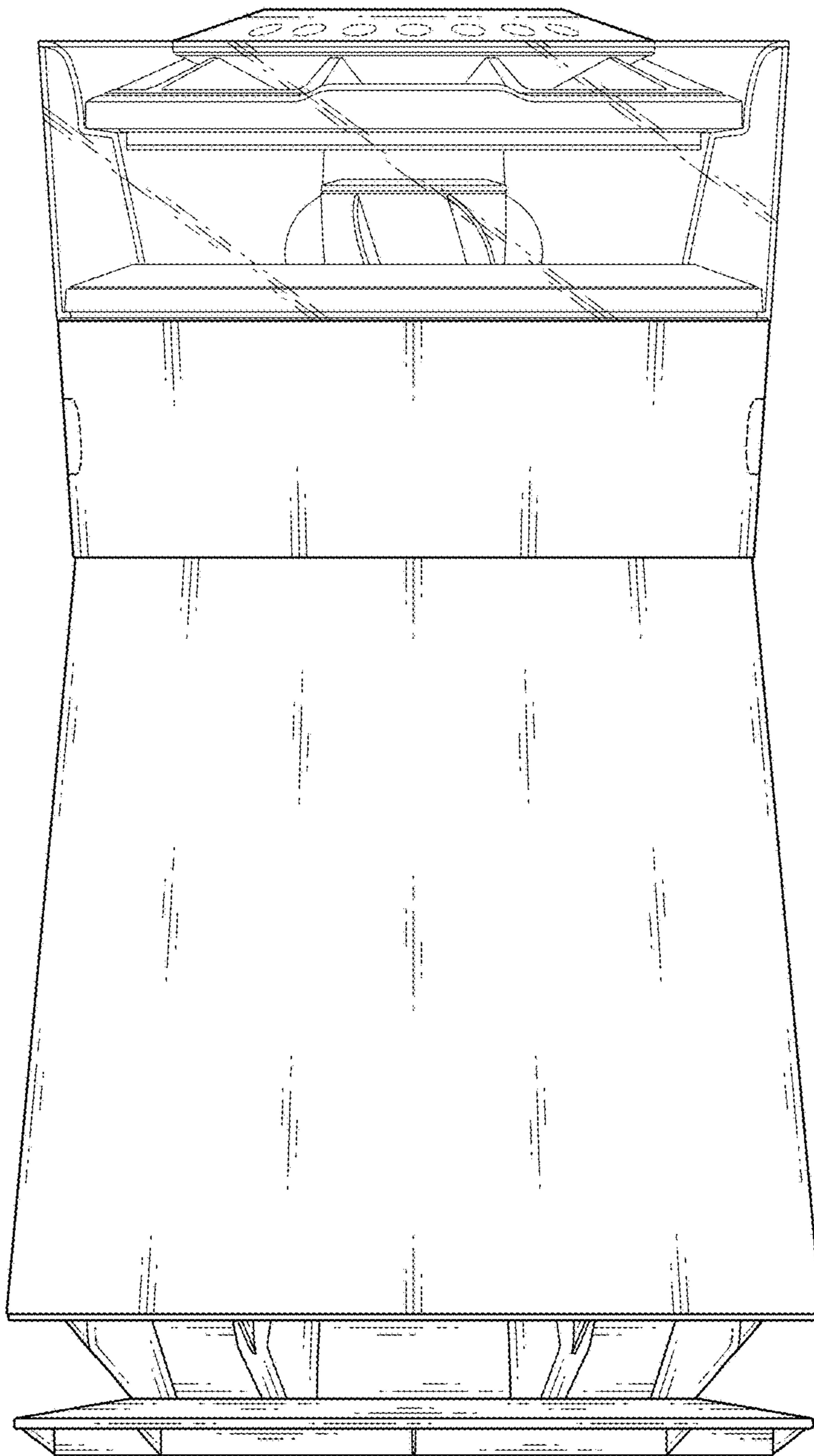

FIG. 3

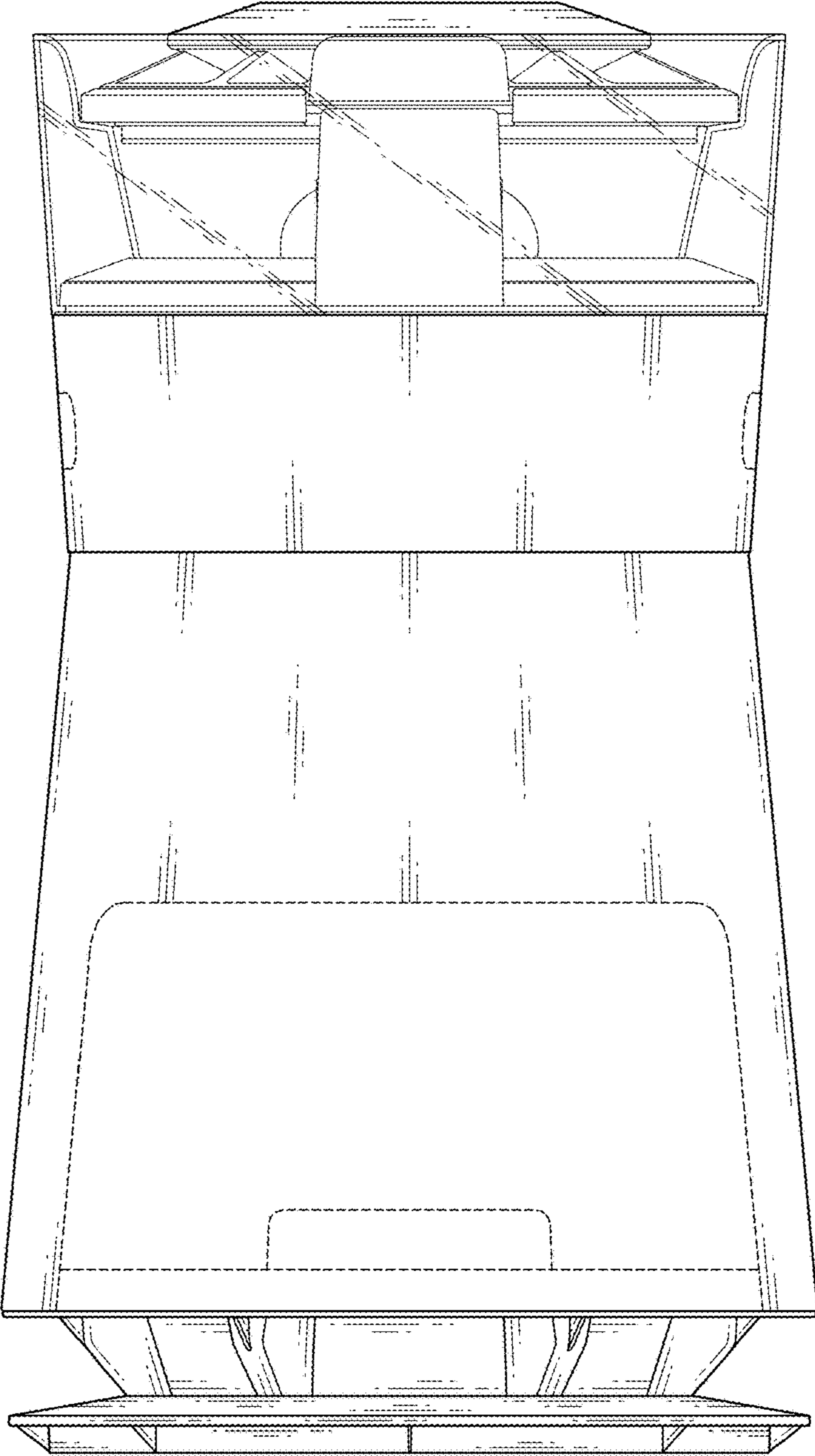

FIG. 4

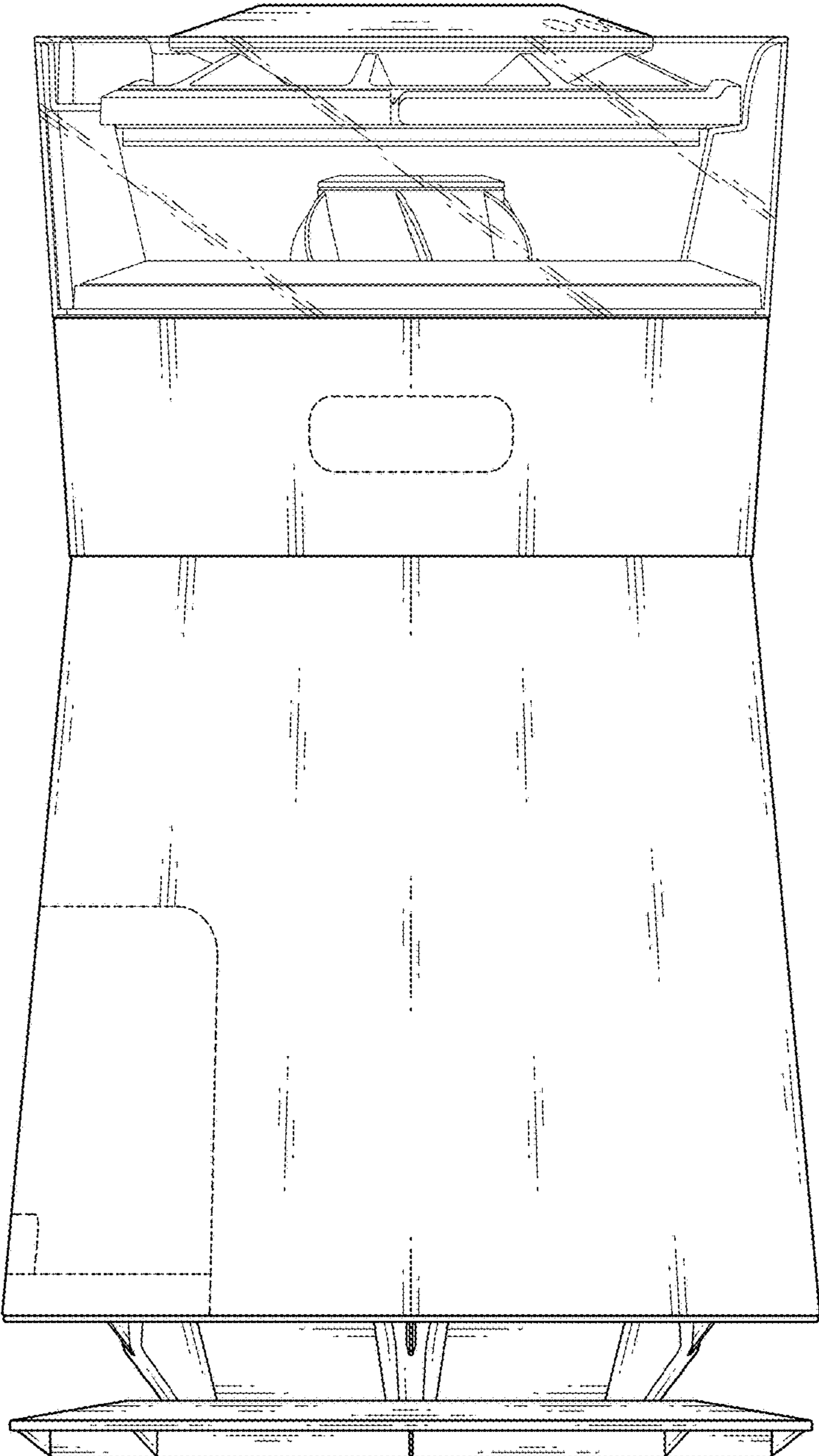

FIG. 5

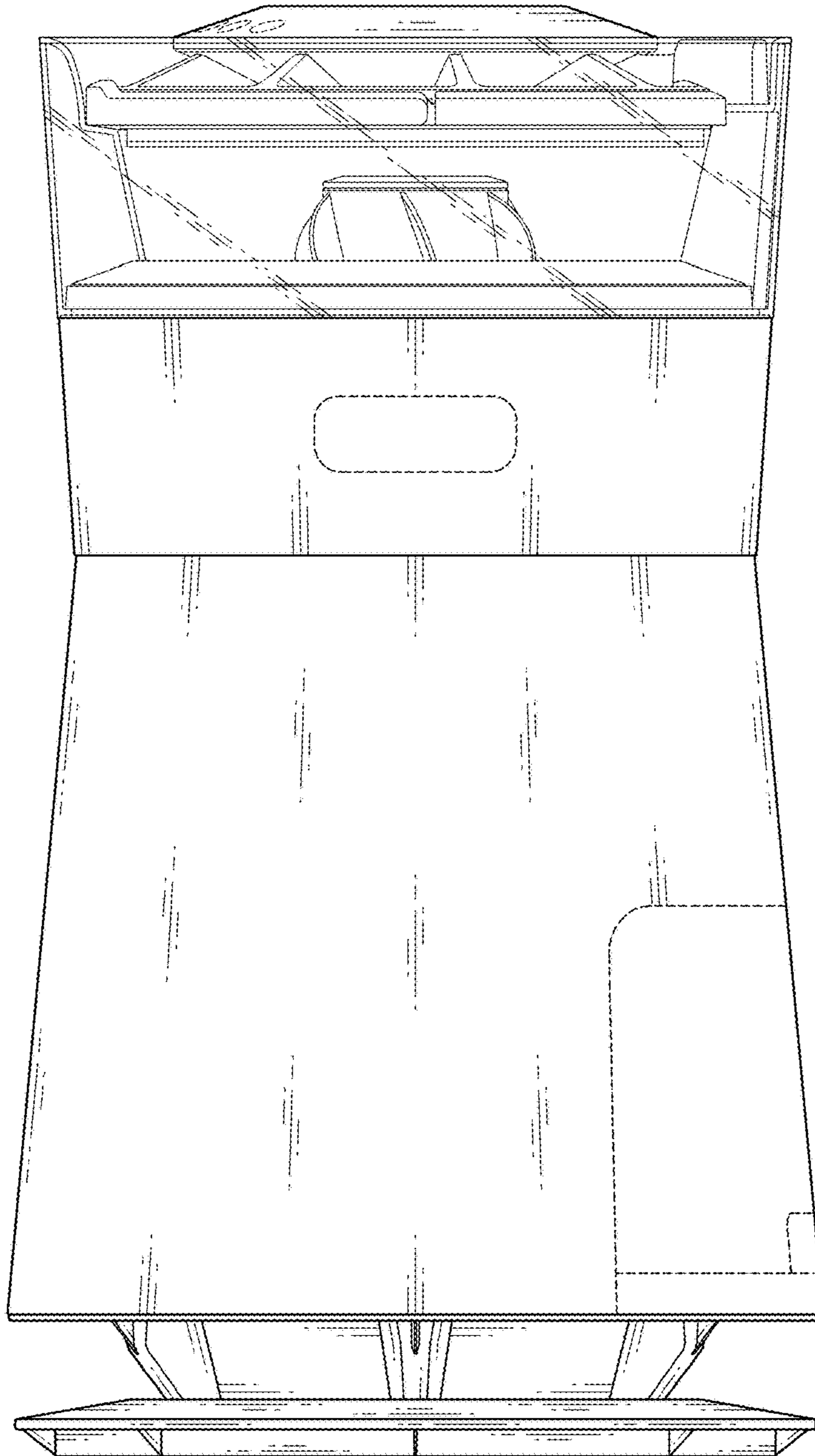

FIG. 6

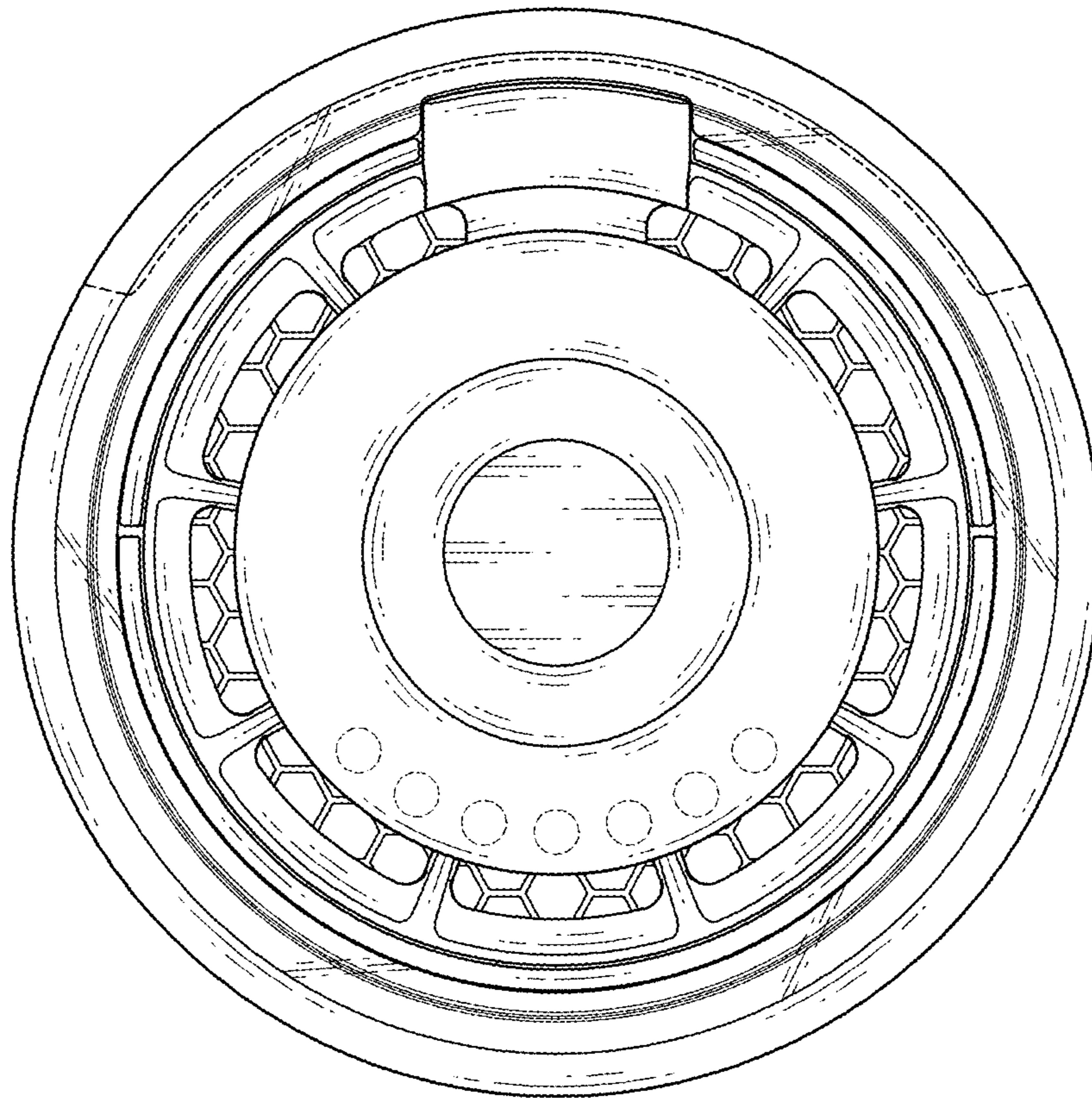

FIG. 7

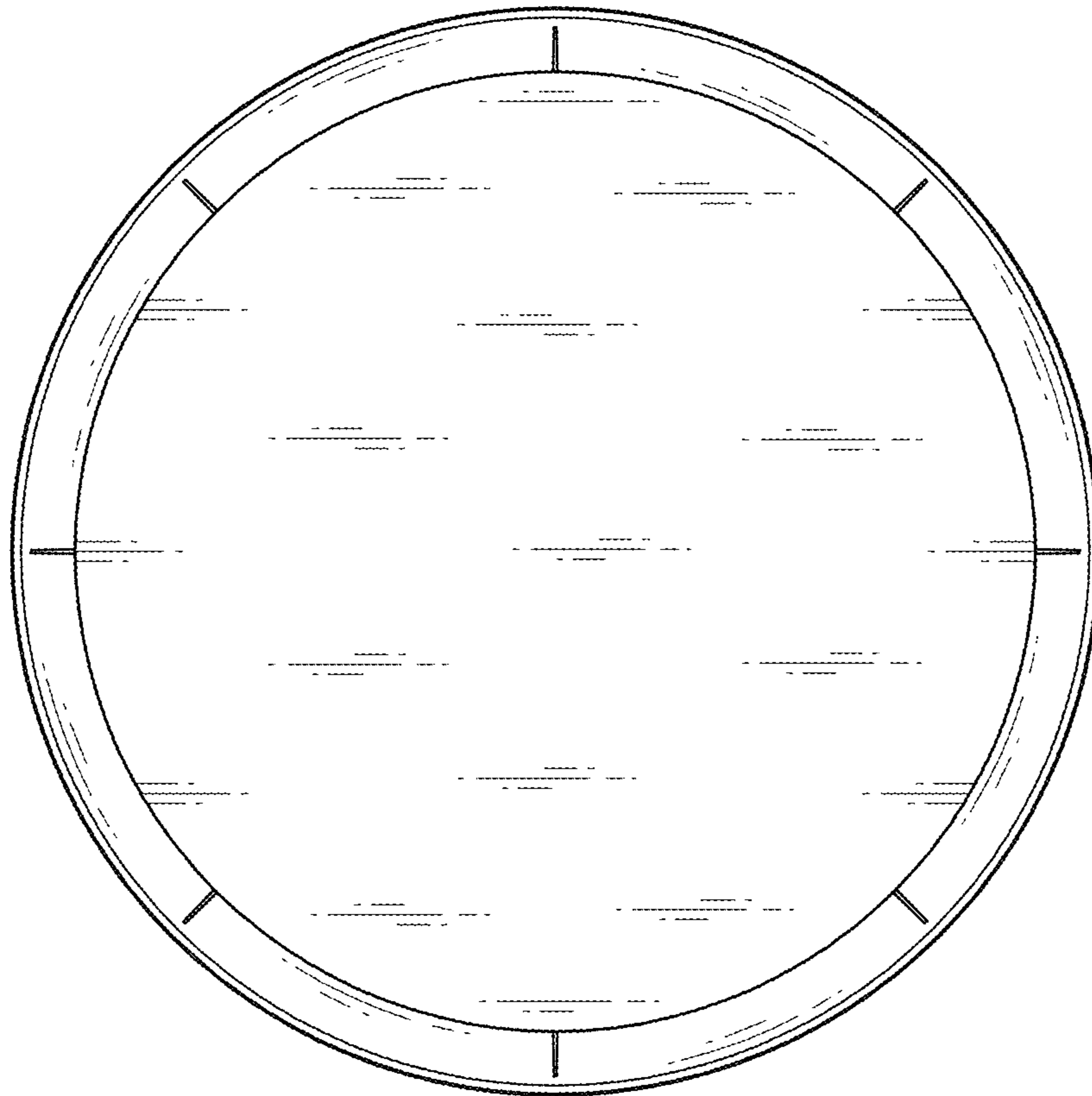

FIG. 8

