



US00D820357S

(12) **United States Design Patent** (10) **Patent No.:** **US D820,357 S**
Onesti et al. (45) **Date of Patent:** **** Jun. 12, 2018**

(54) **LABEL BOOK**

(71) Applicants: **Mirco Onesti**, Milan (IT); **Alice Tacconi**, Milan (IT)

(72) Inventors: **Mirco Onesti**, Milan (IT); **Alice Tacconi**, Milan (IT)

(**) Term: **15 Years**

(21) Appl. No.: **29/587,158**

(22) Filed: **Dec. 9, 2016**

(51) **LOC (11) Cl.** **19-08**

(52) **U.S. Cl.**
USPC **D20/27**

(58) **Field of Classification Search**
USPC D20/10, 11, 22-29, 35, 39, 40, 99
CPC G09F 1/00; G09F 1/02; G09F 2003/023;
G09F 2003/0261; G09F 2003/0208; G09F
2003/0264; G09F 7/00; G09F 3/206;
G09F 13/00; G09F 2007/1807; G09F
13/04; G09F 2013/0427; G09F
2013/0495; G09D 3/00

See application file for complete search history.

(56) **References Cited**

U.S. PATENT DOCUMENTS

- 5,342,093 A * 8/1994 Weernink G09F 3/10
283/81
- 5,727,819 A * 3/1998 Grosskopf G09F 3/0289
283/81
- 6,613,410 B1 * 9/2003 Sellars G09F 3/0288
281/2
- 7,497,041 B1 * 3/2009 Laurence G09F 3/0289
40/306

(Continued)

Primary Examiner — Mary Ann Calabrese

Assistant Examiner — Sloan Rozin

(74) *Attorney, Agent, or Firm* — Hedman & Costigan,
P.C.; James V. Costigan; Kathleen A. Costigan

(57) **CLAIM**

We claim the ornamental design for a label book, as shown and described.

DESCRIPTION

FIG. 1 is a right side, top perspective view of a first embodiment of a label book with a pull tab protruding from the bottom edge of the cover of the label book and showing our new design;

FIG. 2 is a front elevation view thereof;

FIG. 3 is a back elevation view thereof;

FIG. 4 is a left side view thereof;

FIG. 5 is a right side view thereof;

FIG. 6 is a top plan view thereof;

FIG. 7 is a bottom plan view thereof;

FIG. 8 is a right side, top perspective view thereof showing the first embodiment of a label book with the pull tab removed;

FIG. 9 is a right side, top perspective view of a second embodiment of a label book with an aperture on the first page of the label book showing a length of string horizontally mounted between the bottle and the label book with a stylized, ornamental bow or knot in the string showing our new design;

FIG. 10 is a front elevation view thereof;

FIG. 11 is a back elevation view thereof;

FIG. 12 is a left side view thereof;

FIG. 13 is a right side view thereof;

FIG. 14 is a top plan view thereof;

FIG. 15 is a bottom plan view thereof; and,

FIG. 16 is a right side, top perspective view thereof showing the second embodiment of a label book open and the interior pages thereof.

The bottle is shown in broken lines and forms no part of the claimed design.

The lettering in FIGS. 8 and 16 is shown in broken lines and forms no part of the claimed design.

The broken lines on the cover of the label in the first embodiment represent perforations and is part of the claimed design.

1 Claim, 14 Drawing Sheets

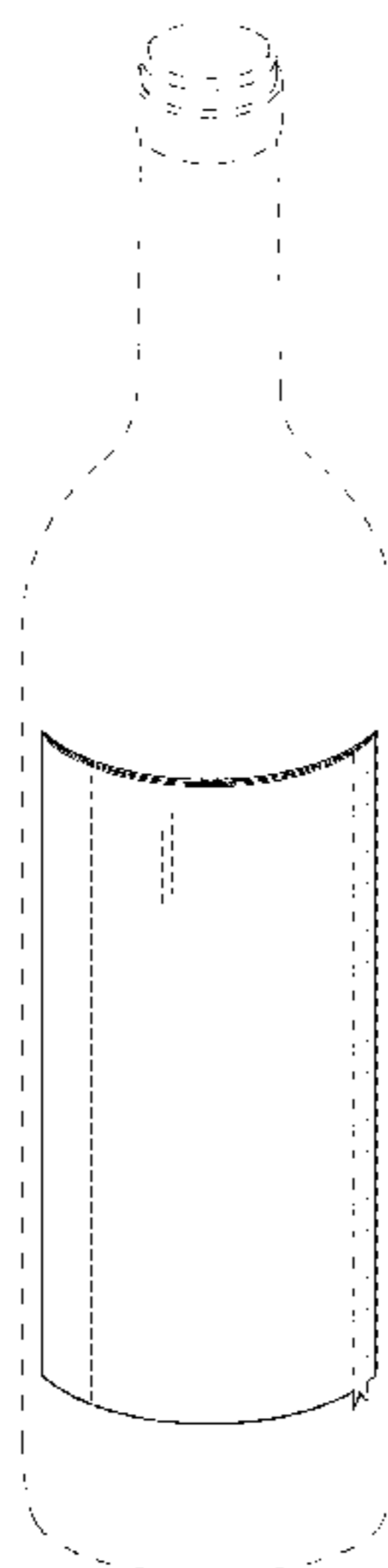

(56)

References Cited

U.S. PATENT DOCUMENTS

7,740,411 B2 * 6/2010 Kaufman B42D 15/00
283/106
D691,475 S * 10/2013 Potts D9/500
9,085,402 B2 * 7/2015 Key B65D 85/00
D739,743 S * 9/2015 Klarin D9/500
9,193,491 B1 * 11/2015 Miceli B65D 1/0246
D750,176 S * 2/2016 El-Afandi D20/22
D763,692 S * 8/2016 Forsberg D20/27
D767,399 S * 9/2016 Forsberg D20/22
D768,781 S * 10/2016 Peruffo D20/27
D781,378 S * 3/2017 Miceli D20/22
D791,594 S * 7/2017 Klarin D9/500
2003/0134073 A1 * 7/2003 Sellars G09F 3/0289
428/40.1

* cited by examiner

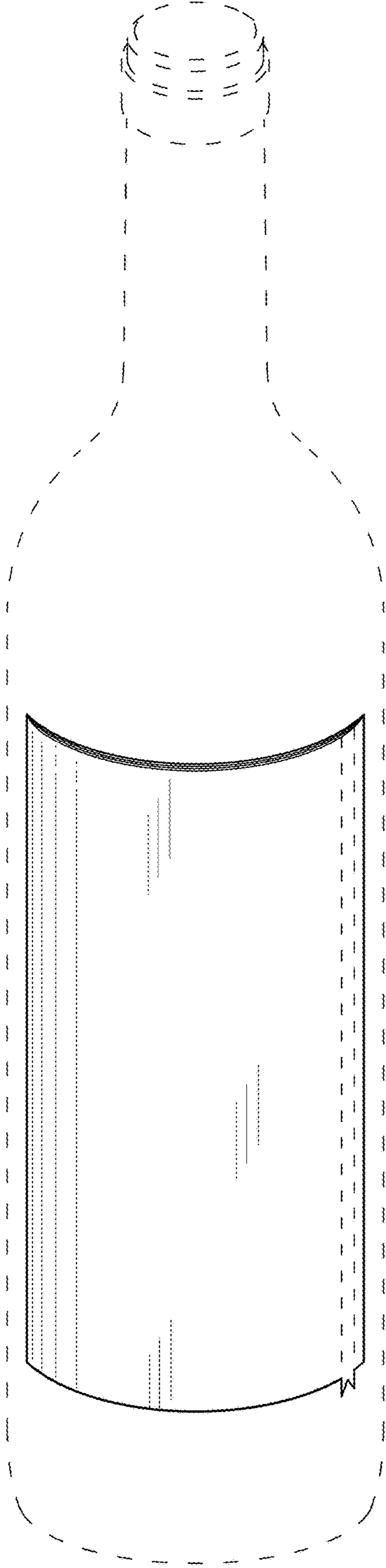

FIG. 1

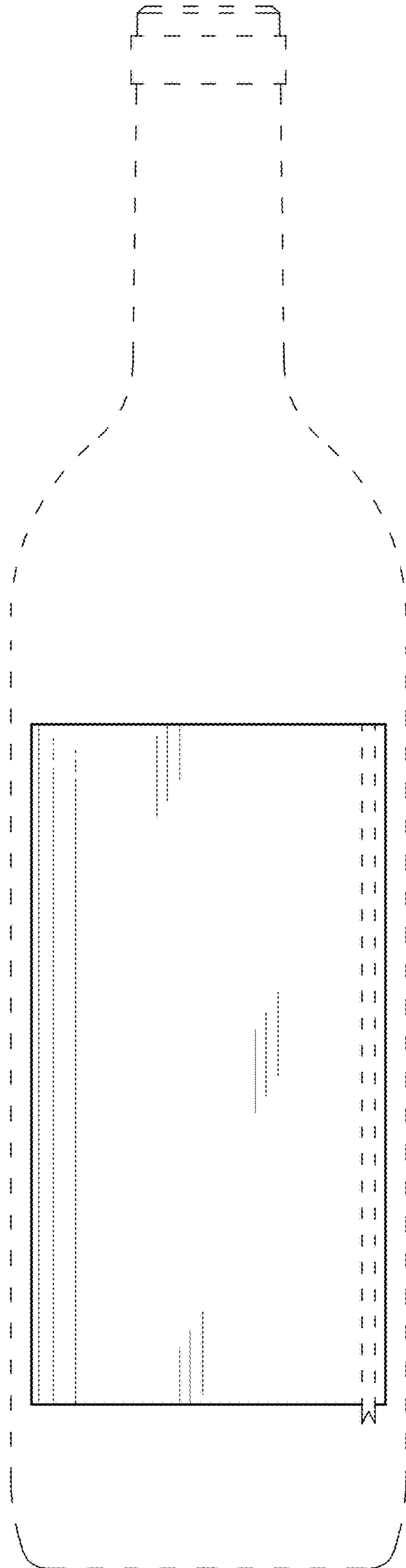

FIG.2

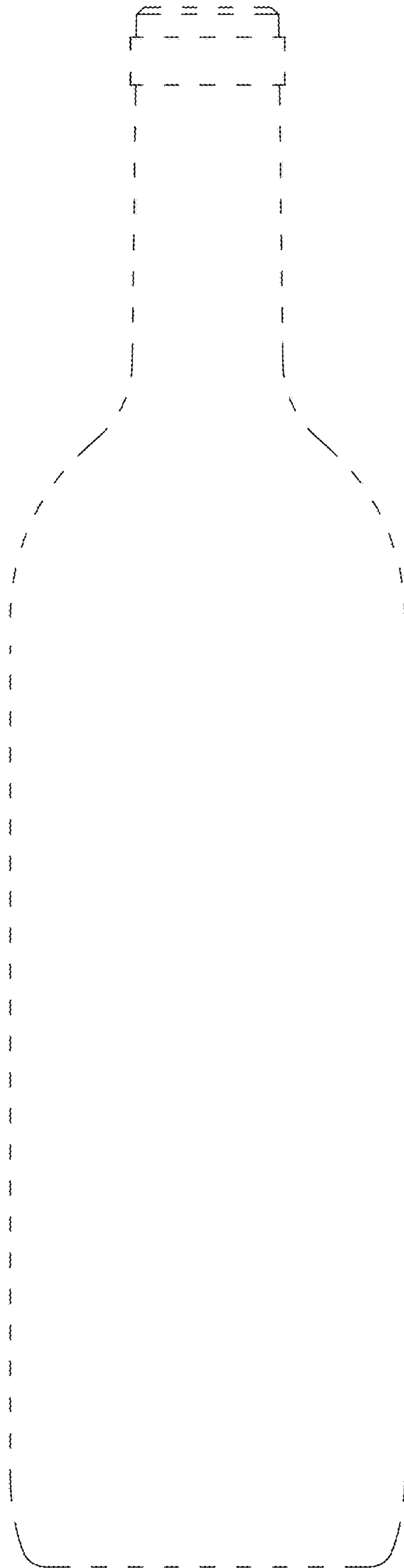

FIG. 3

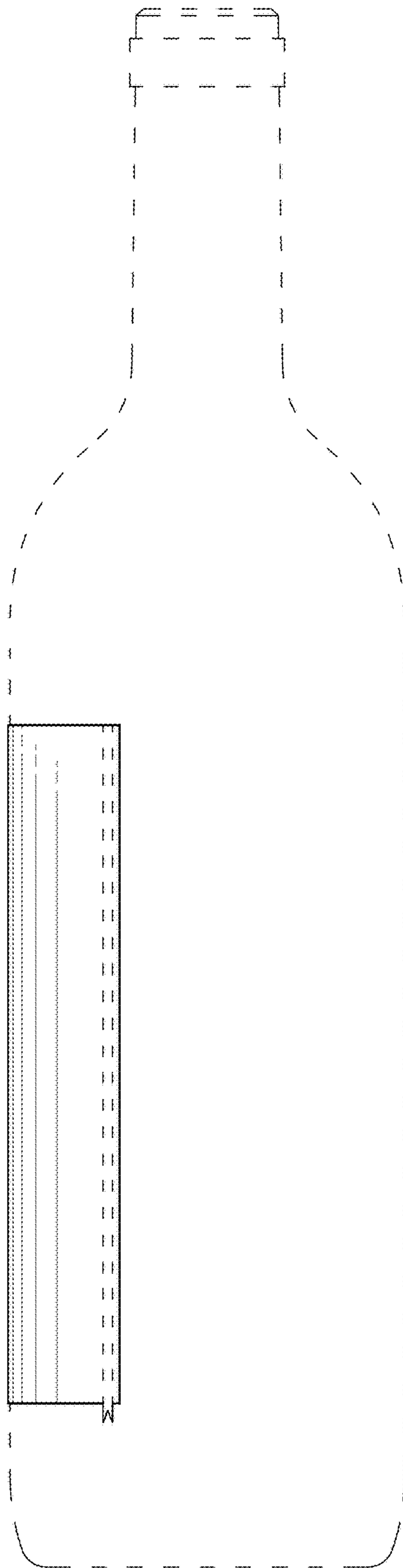

FIG. 4

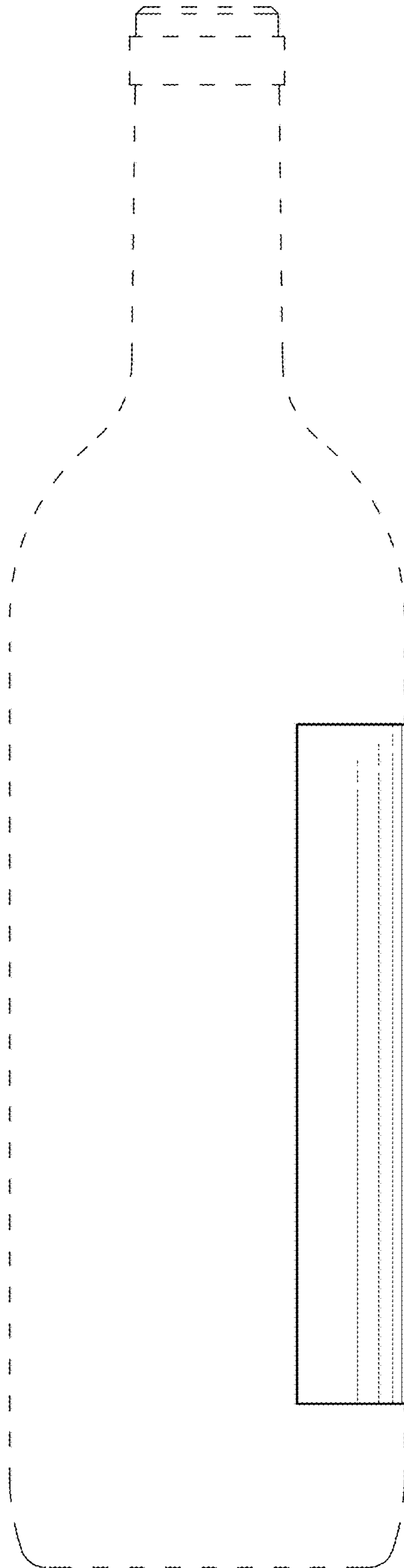

FIG. 5

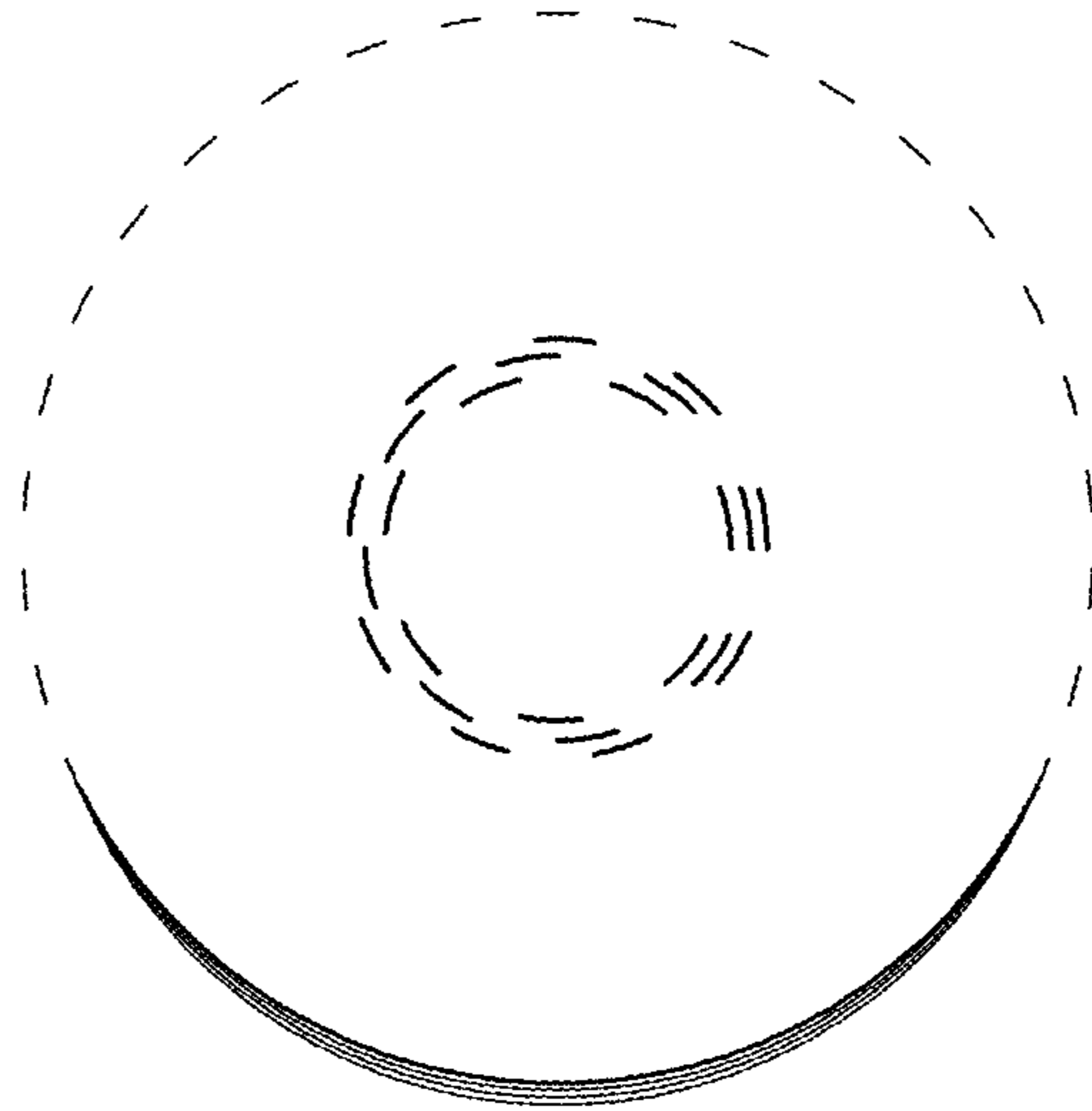

FIG. 6

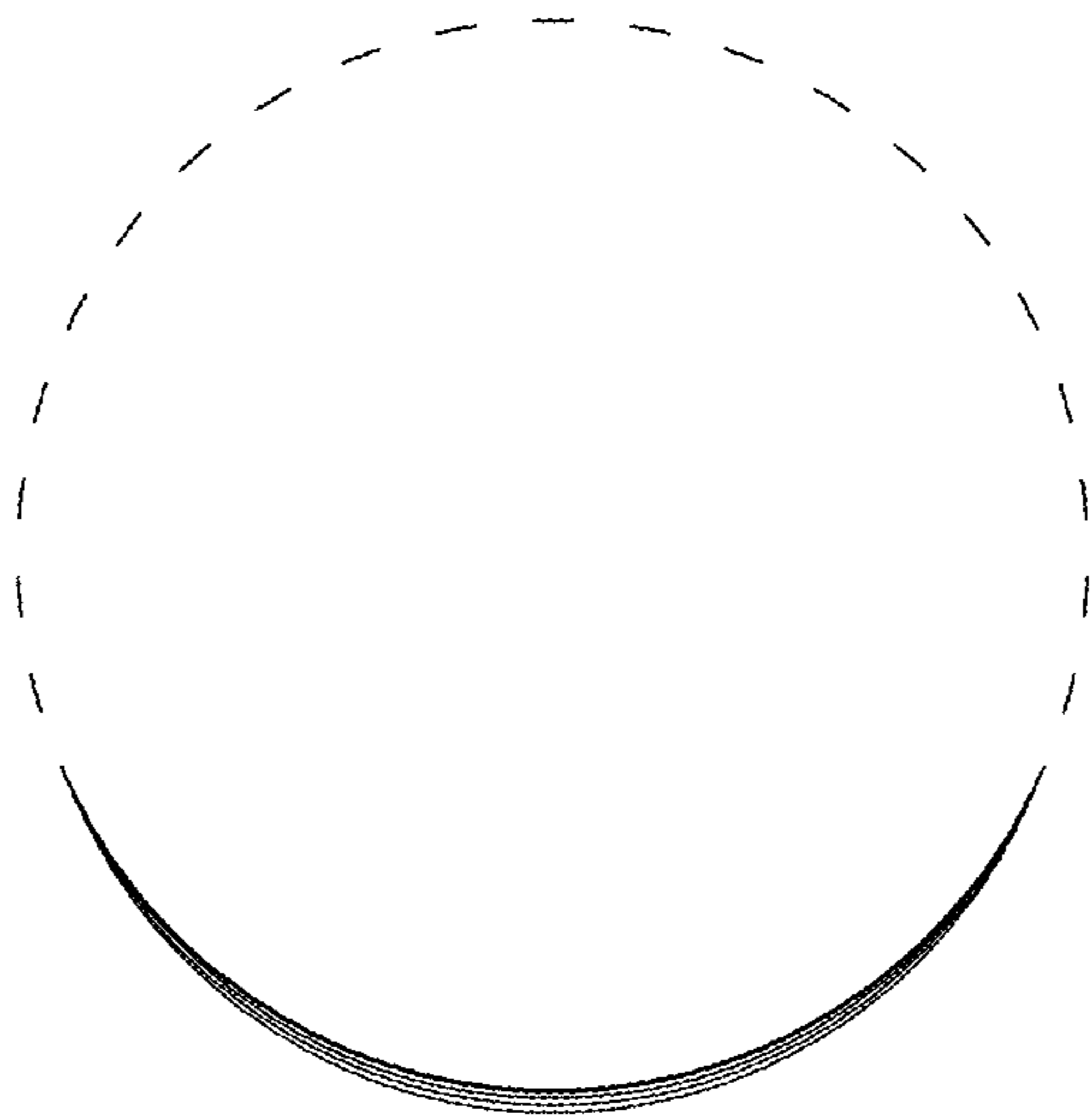

FIG. 7

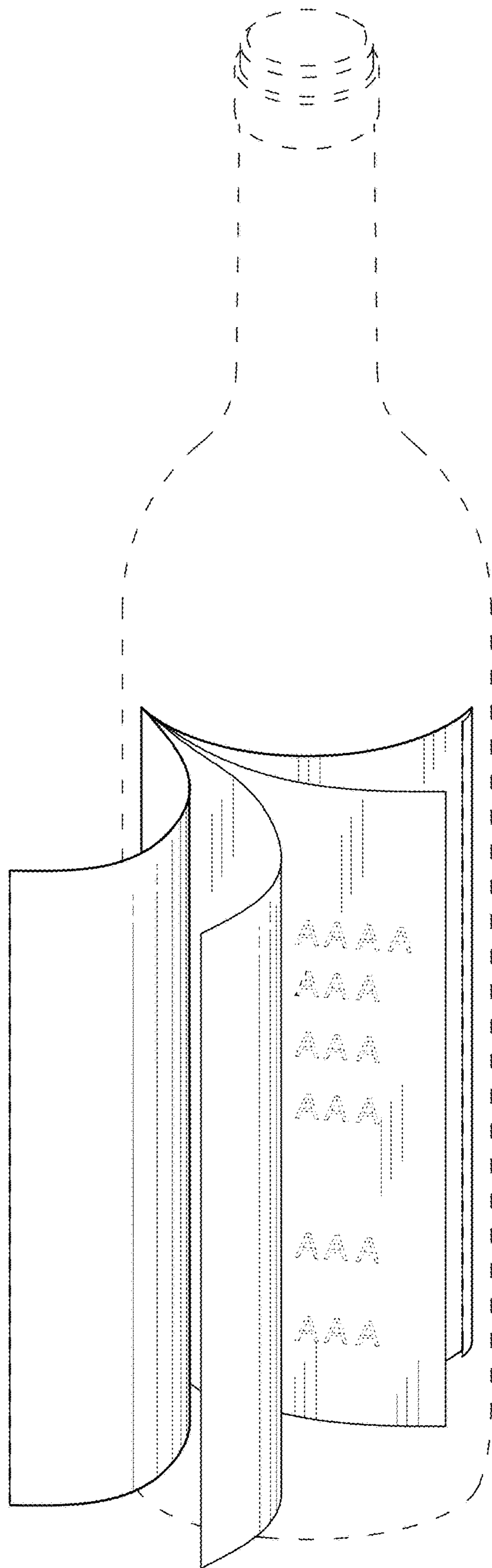

FIG. 8

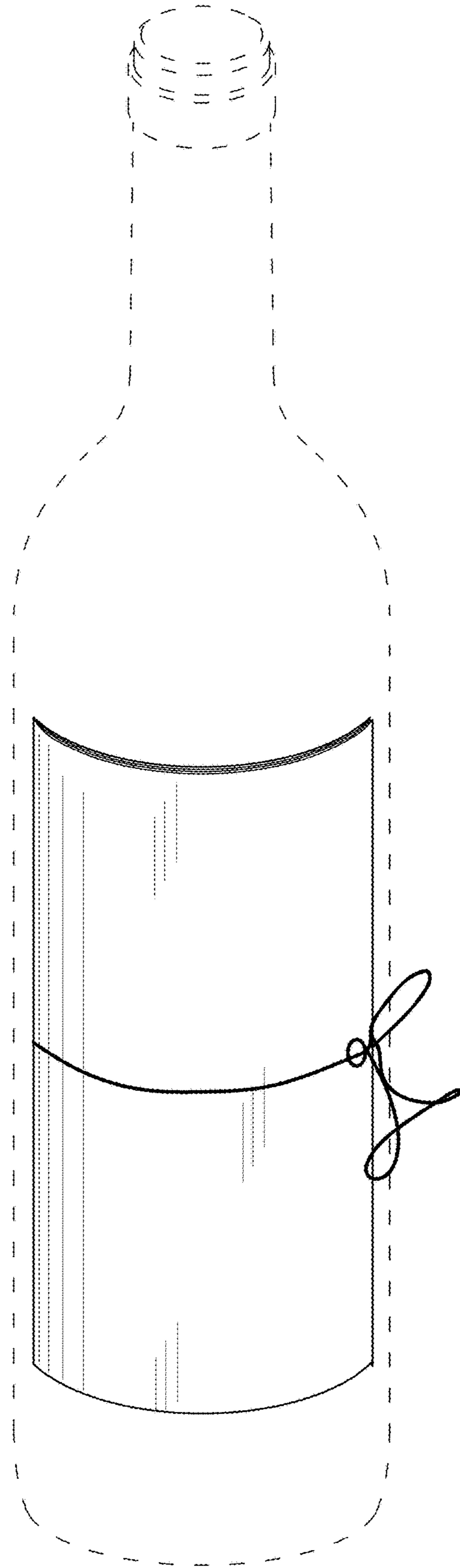

FIG. 9

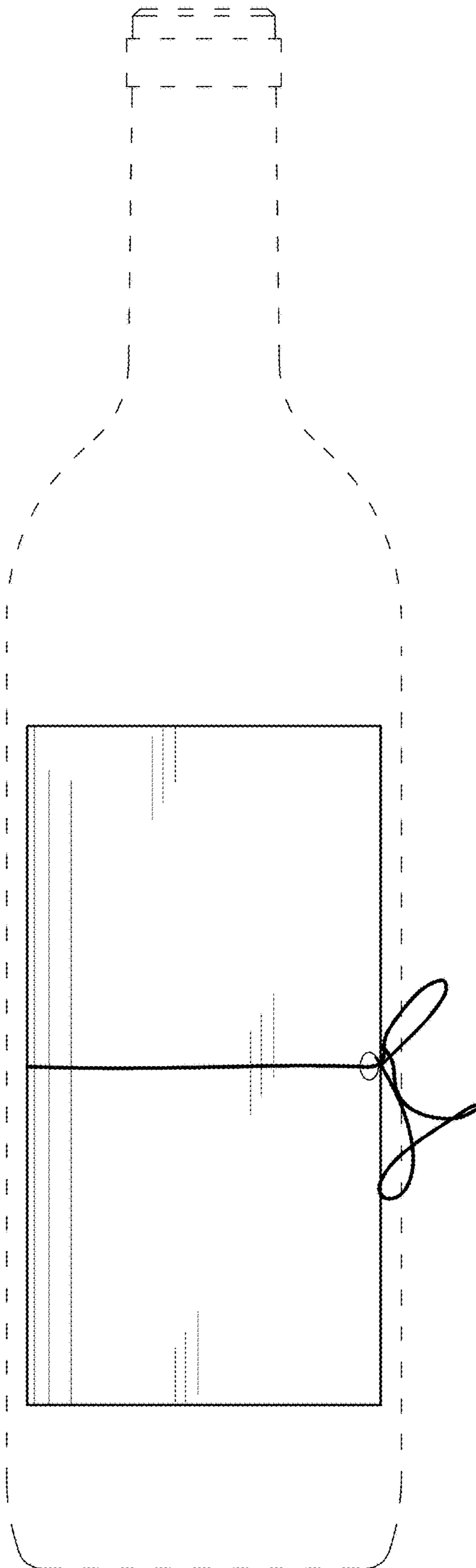

FIG. 10

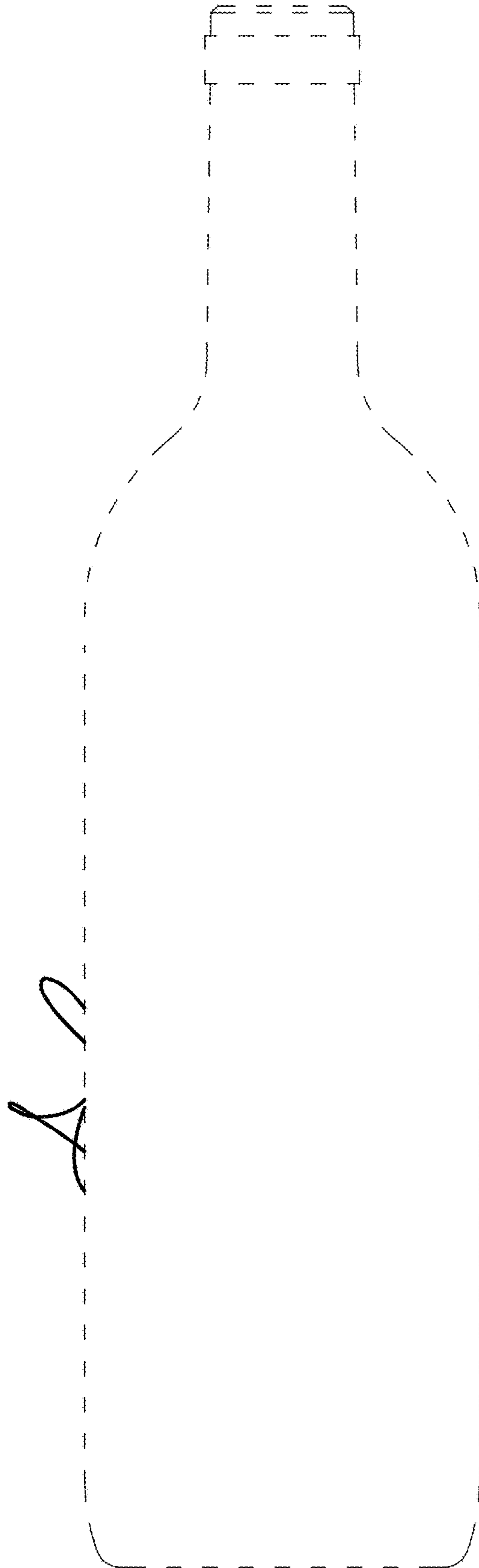

FIG. 11

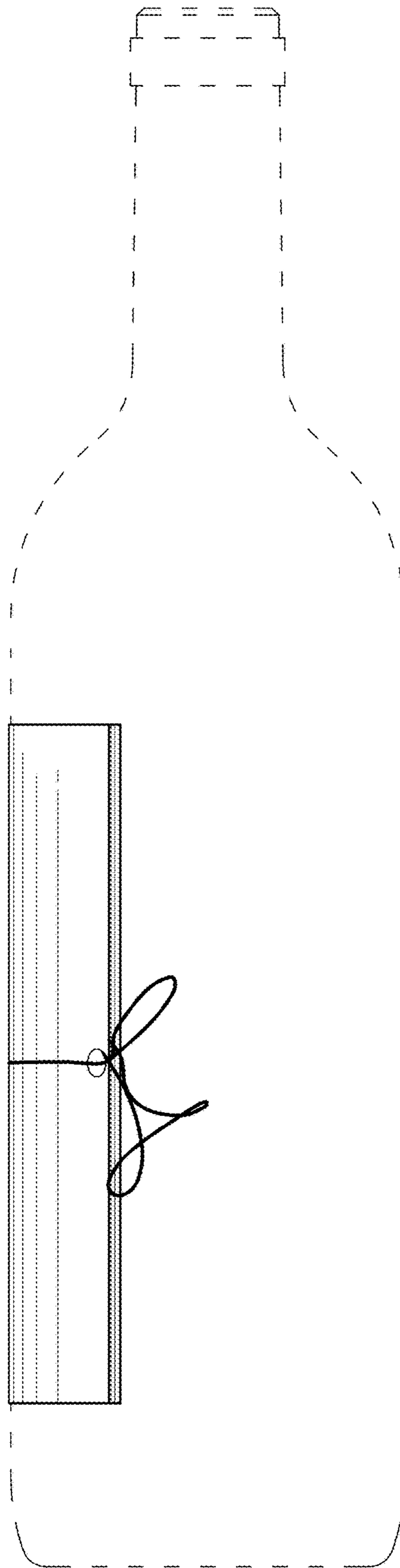

FIG. 12

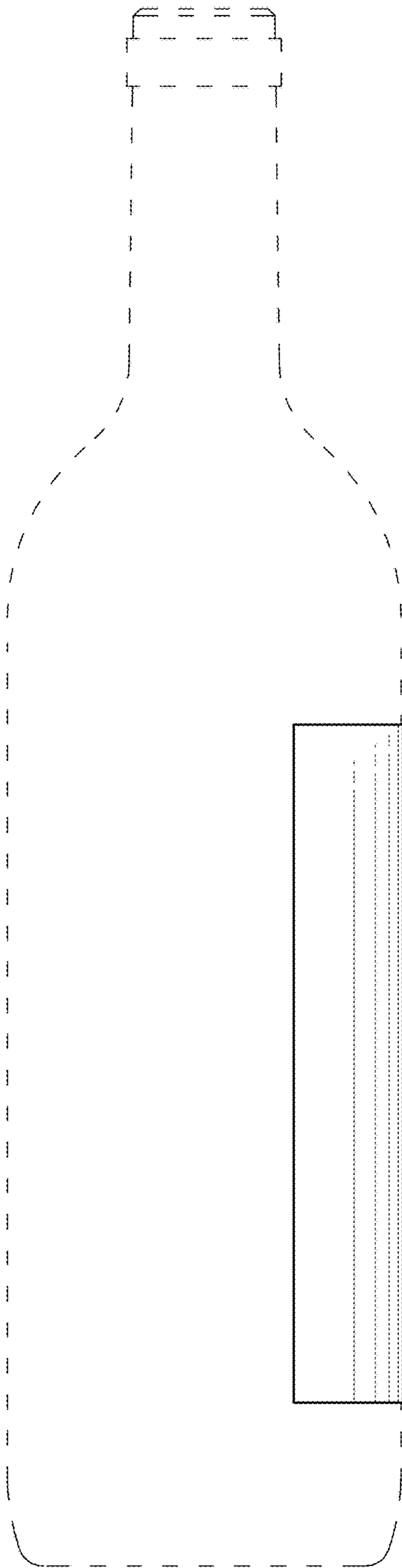

FIG. 13

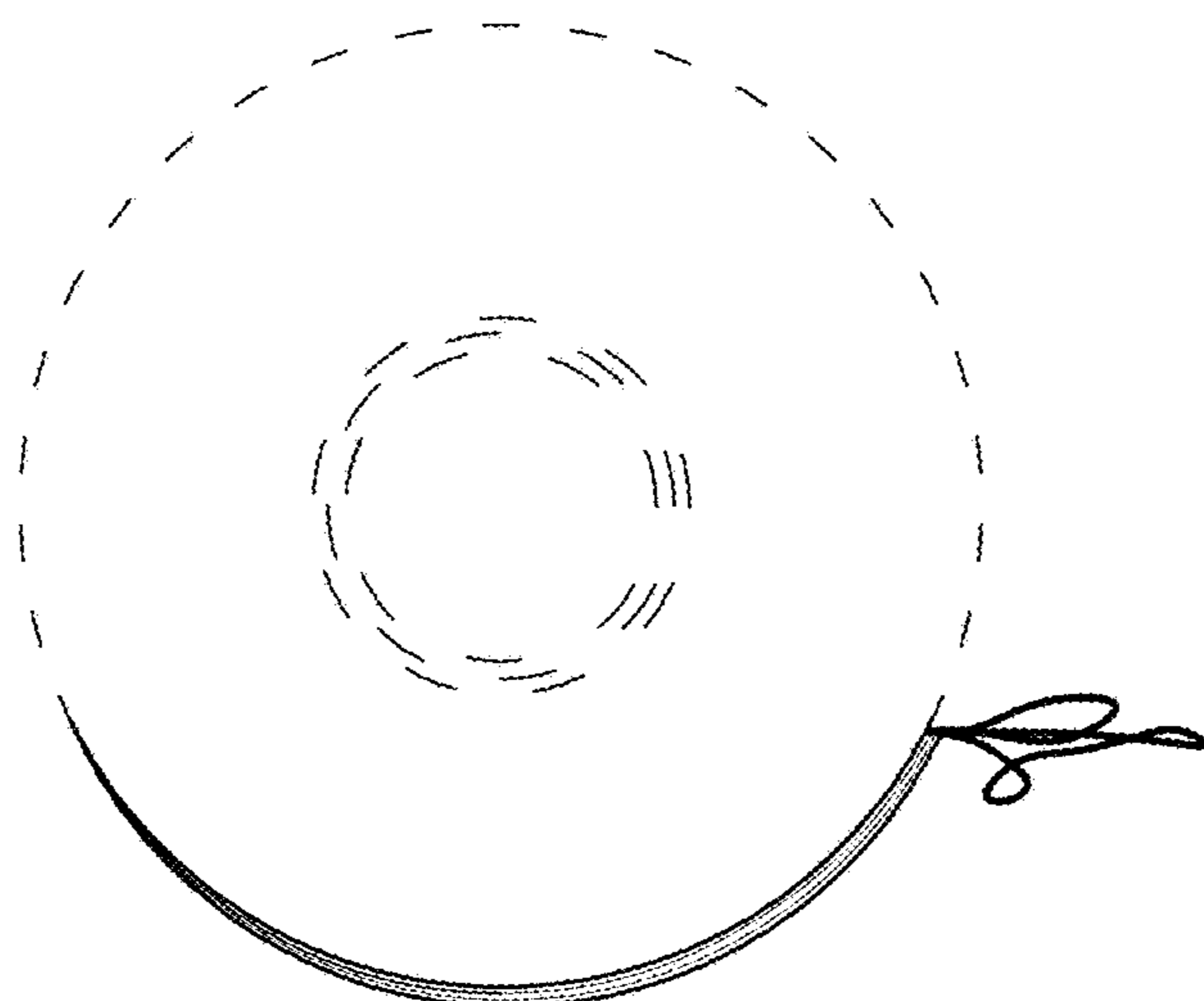

FIG. 14

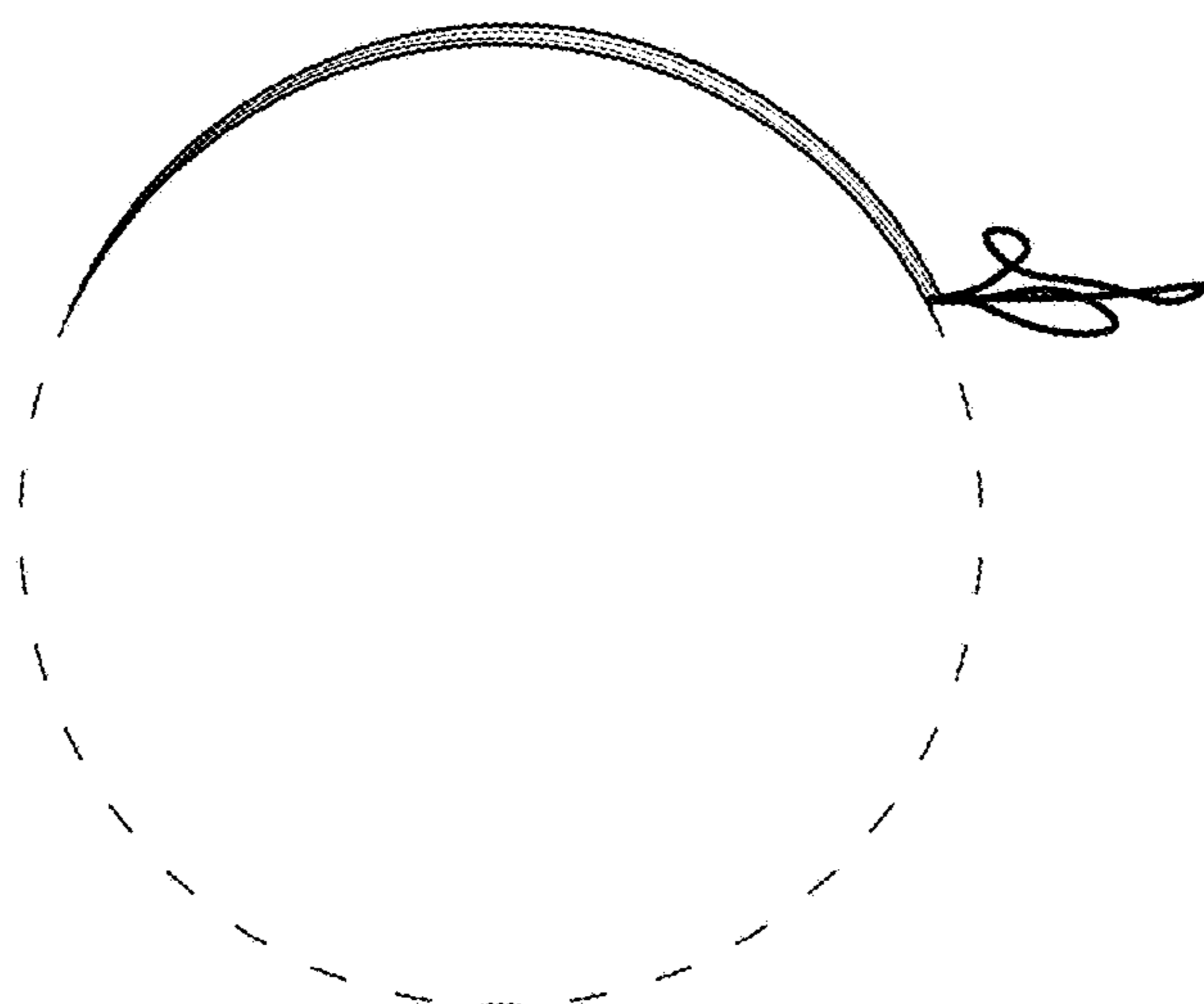

FIG. 15

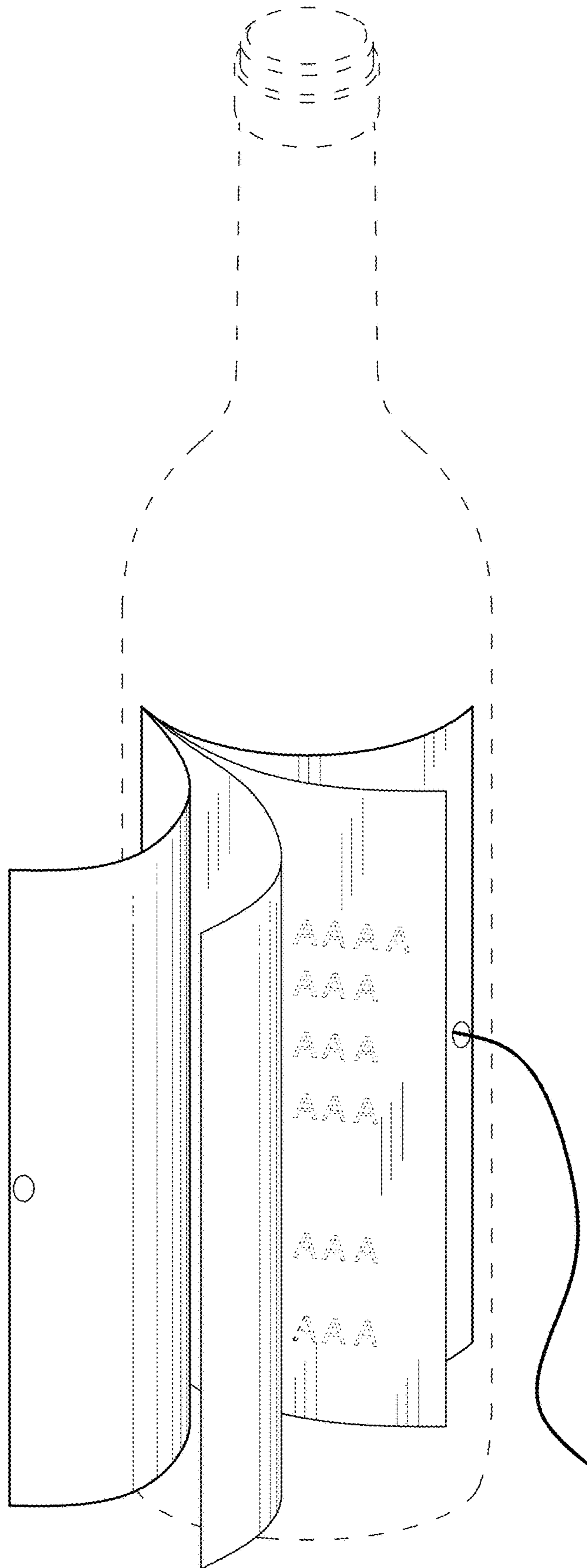

FIG. 16