



US00D820351S

(12) **United States Design Patent** (10) **Patent No.:** **US D820,351 S**
Maeda et al. (45) **Date of Patent:** **** Jun. 12, 2018**

(54) **PRINTER** D533,216 S * 12/2006 Sato D18/50
D594,504 S * 6/2009 Hattori D18/19
(71) Applicant: **BROTHER INDUSTRIES, LTD.,** D730,978 S * 6/2015 Kinoshita D18/50
Nagoya-shi, Aichi-ken (JP) D751,636 S * 3/2016 Kinoshita D18/19
D752,140 S * 3/2016 Tanaka D18/19
(72) Inventors: **Shino Maeda**, Nagoya (JP); **Takaaki** D760,834 S * 7/2016 Takahashi D18/19
Oguchi, Kasugai (JP) D760,835 S * 7/2016 Takahashi D18/19
D777,249 S * 1/2017 Tanaka D18/19
(73) Assignee: **BROTHER INDUSTRIES, LTD.,** D786,342 S * 5/2017 Oguchi D18/50
Nagoya (JP) (Continued)

(**) Term: **15 Years**

FOREIGN PATENT DOCUMENTS

(21) Appl. No.: **29/570,493**

GB 2055913 * 8/1996

(22) Filed: **Jul. 8, 2016**

OTHER PUBLICATIONS

(30) **Foreign Application Priority Data**

YouTube. <URL: <https://www.youtube.com/watch?v=6zSmqC6dYwA>> Feb 15, 2017. 10 Best Label Printers 2017.*

Jan. 8, 2016 (JP) 2016-000283

(51) **LOC (11) Cl.** **19-02**

(52) **U.S. Cl.** **D18/19**

USPC **D18/19**

(58) **Field of Classification Search**

USPC D18/19, 53, 50, 54, 56, 59, 36, 38, 39,
D18/40, 41, 45, 34.4, 34.5, 34.6;
D14/314, 332, 348-349, 351, 352;
D19/68

CPC B41J 3/4075; B65C 11/00; B65C 11/02;
B65C 11/0205; B65C 11/021; B65C
11/0215; B65C 11/0221; B65C 11/0226;
B65C 11/0231; B65C 11/0236; B65C
11/0242; B65C 11/0252; B65C 11/0257;
B65C 11/0268; B65C 11/0273; B65C
11/0284; B65C 11/0289; B65C 11/0294;
B65C 11/04; B65C 11/046; B65C 11/06;
B65C 11/062; B65C 11/064; B65C
11/066; B65C 11/068

See application file for complete search history.

(56) **References Cited**

U.S. PATENT DOCUMENTS

D447,766 S * 9/2001 Obara D18/19
D489,082 S * 4/2004 Nakaeda D18/19

Primary Examiner — Bridget L Eland
Assistant Examiner — Lauren McVey
(74) *Attorney, Agent, or Firm* — Oliff PLC

(57) **CLAIM**

The ornamental design for a printer, as shown and described.

DESCRIPTION

FIG. 1 is a top right perspective view of a printer, showing our new design;
FIG. 2 is a front elevation view thereof;
FIG. 3 is a top plan view thereof;
FIG. 4 is a right-side elevation view thereof;
FIG. 5 is a left-side elevation view thereof;
FIG. 6 is a rear elevation view thereof; and,
FIG. 7 is a bottom plan view thereof.
The broken lines that are immediately adjacent to the claim represent the bounds of the claimed design; the broken lines form no part of the claimed design.

1 Claim, 7 Drawing Sheets

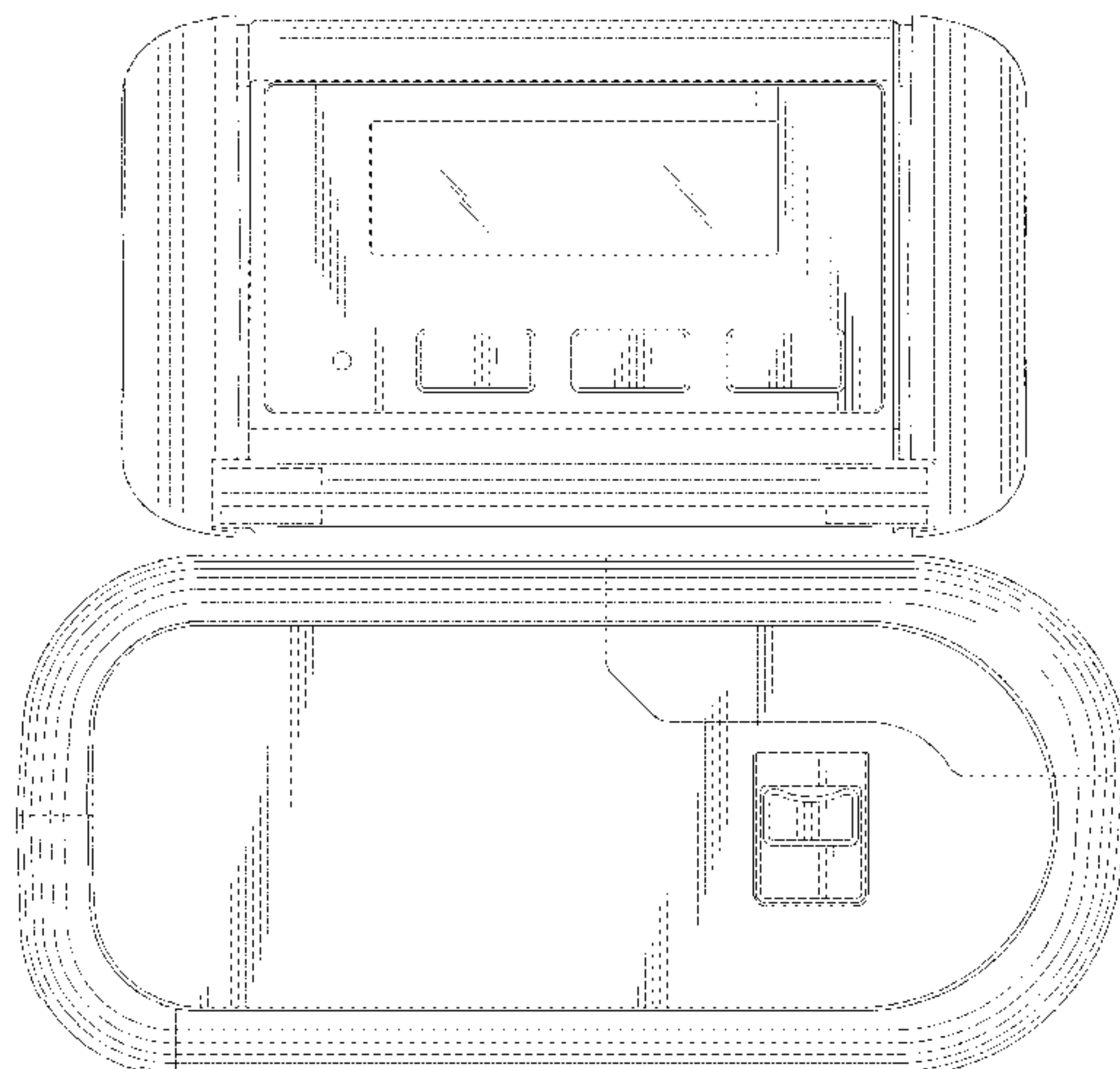

(56)

References Cited

U.S. PATENT DOCUMENTS

D790,006 S * 6/2017 Yoshida D18/14
2012/0141184 A1 * 6/2012 Chen B41J 2/325
400/242

* cited by examiner

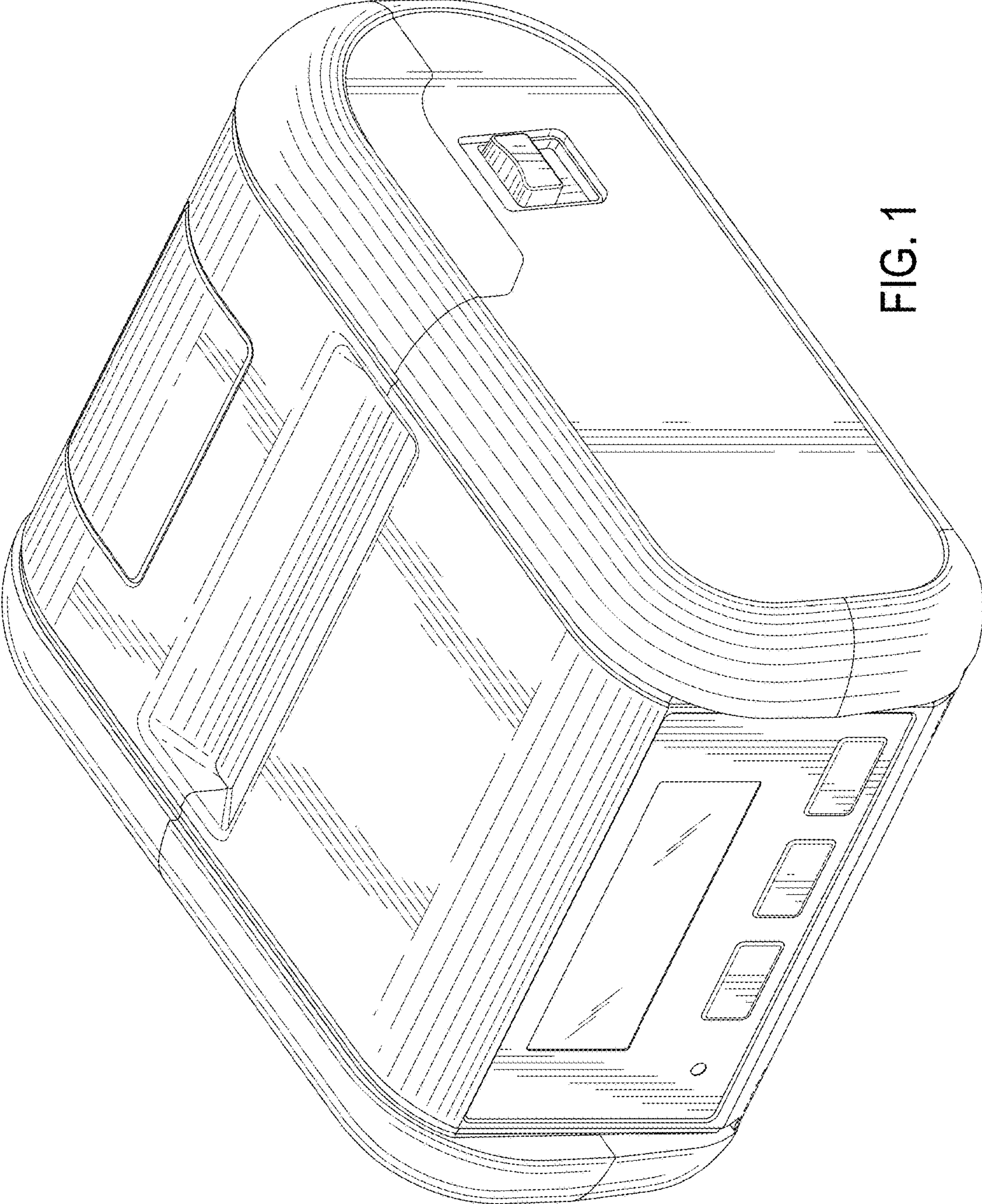

FIG. 1

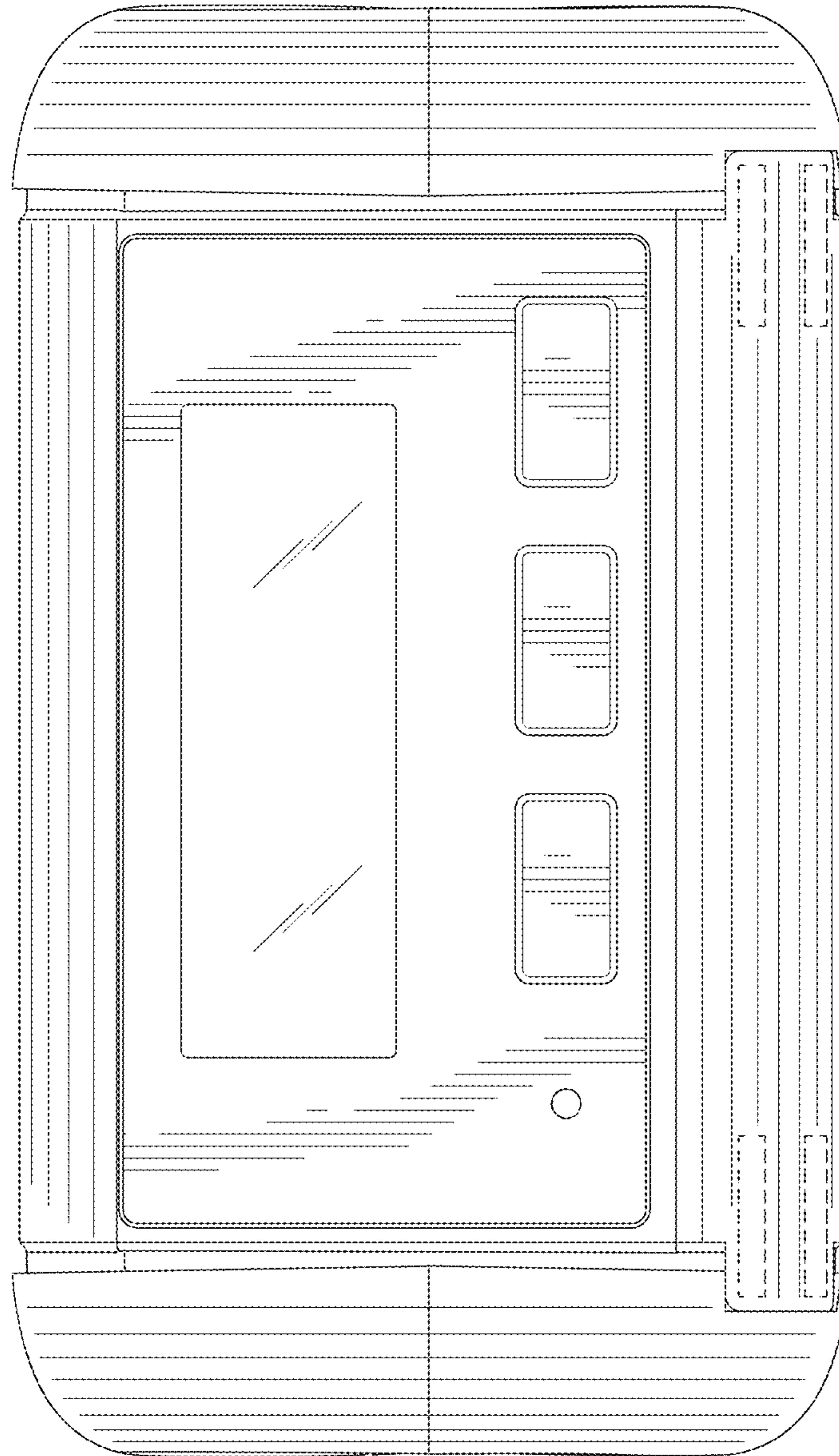

FIG. 2

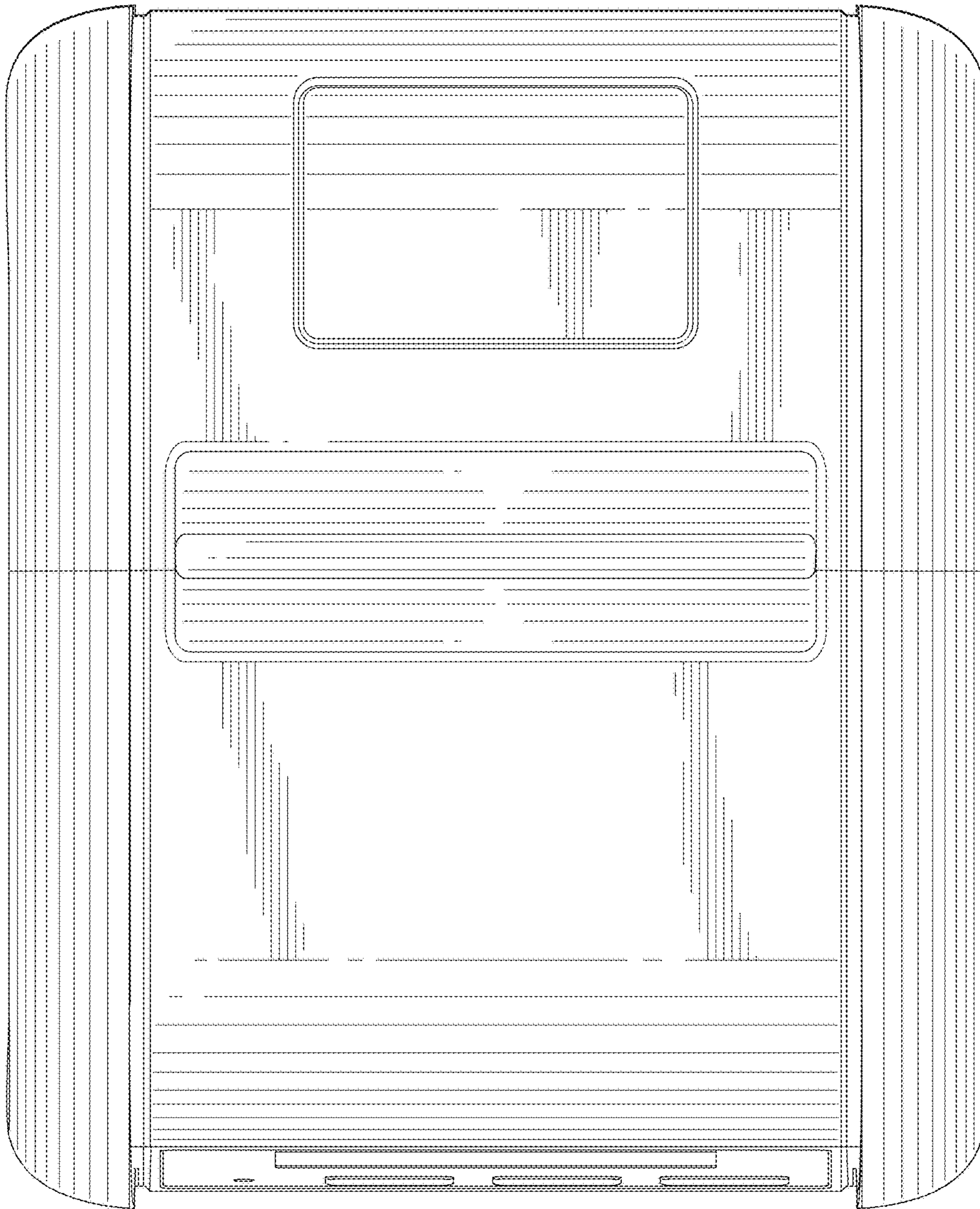

FIG. 3

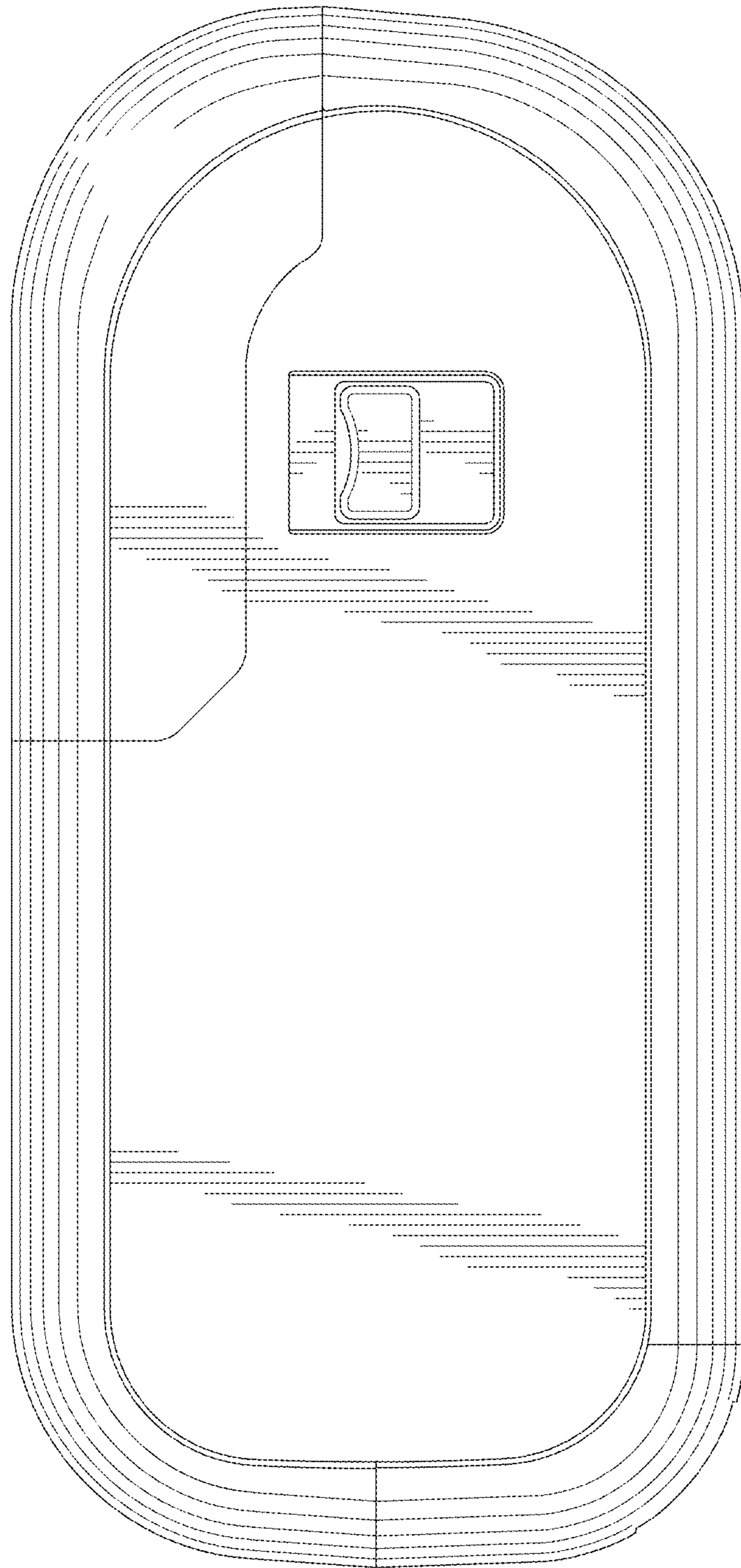

FIG. 4

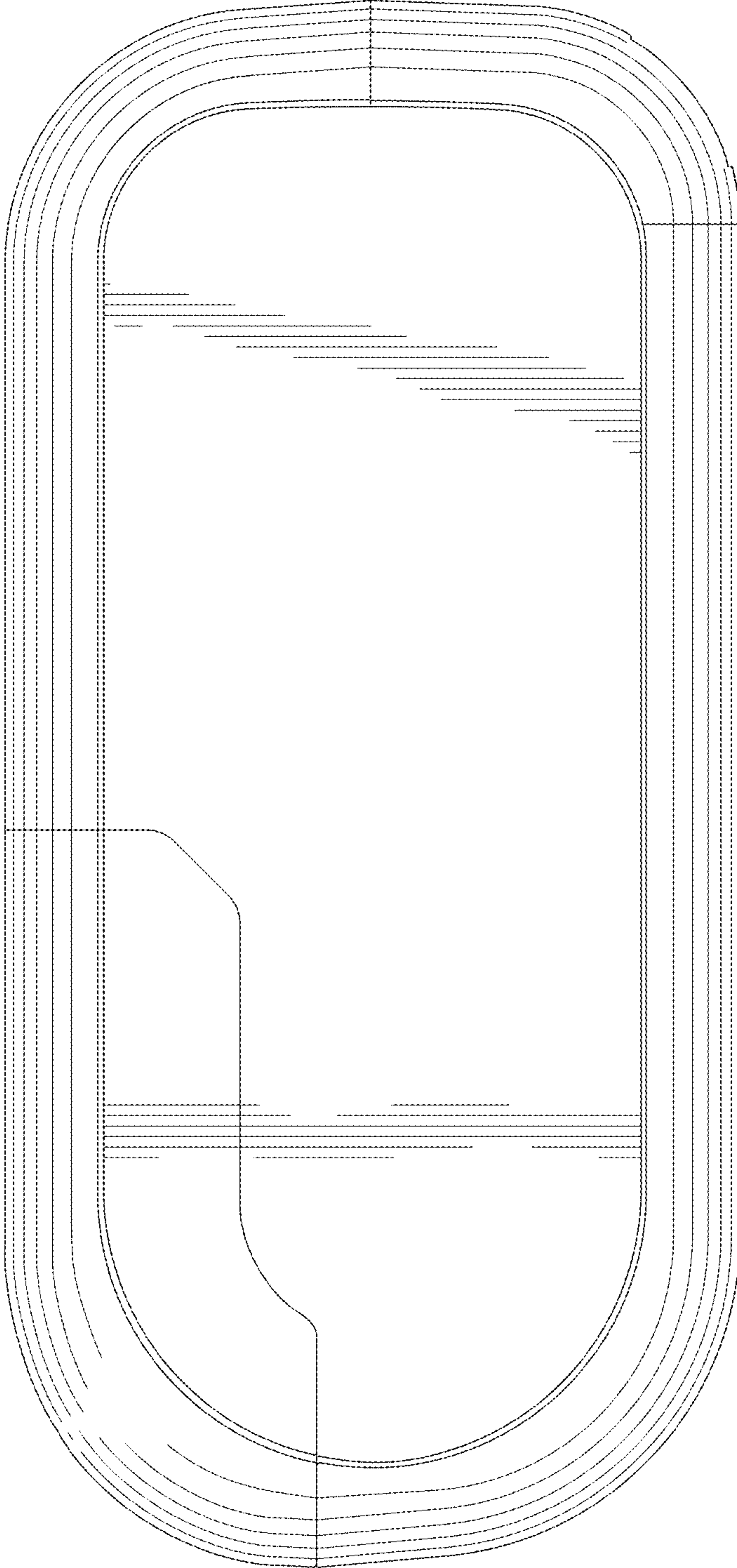

FIG. 5

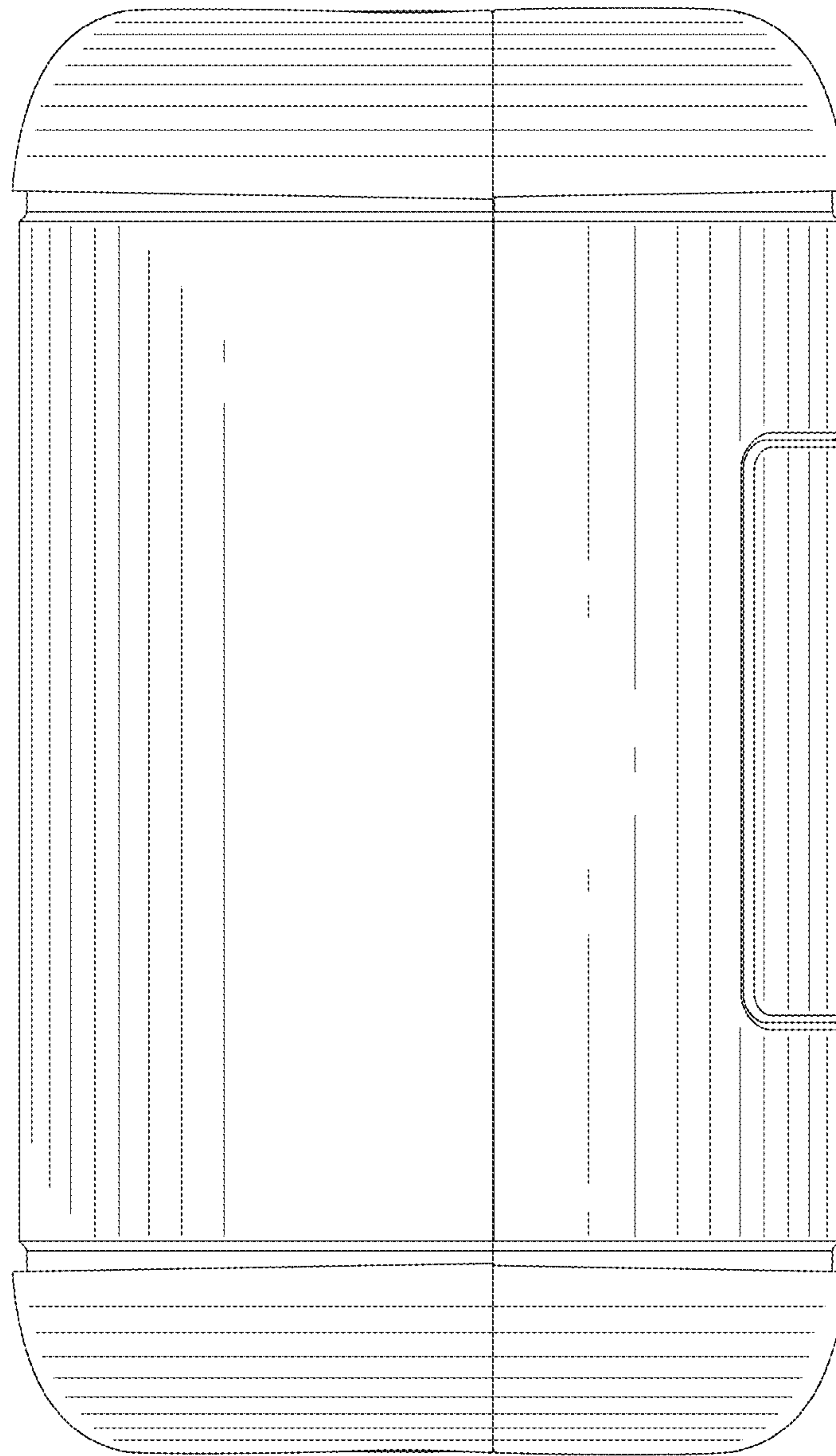

FIG. 6

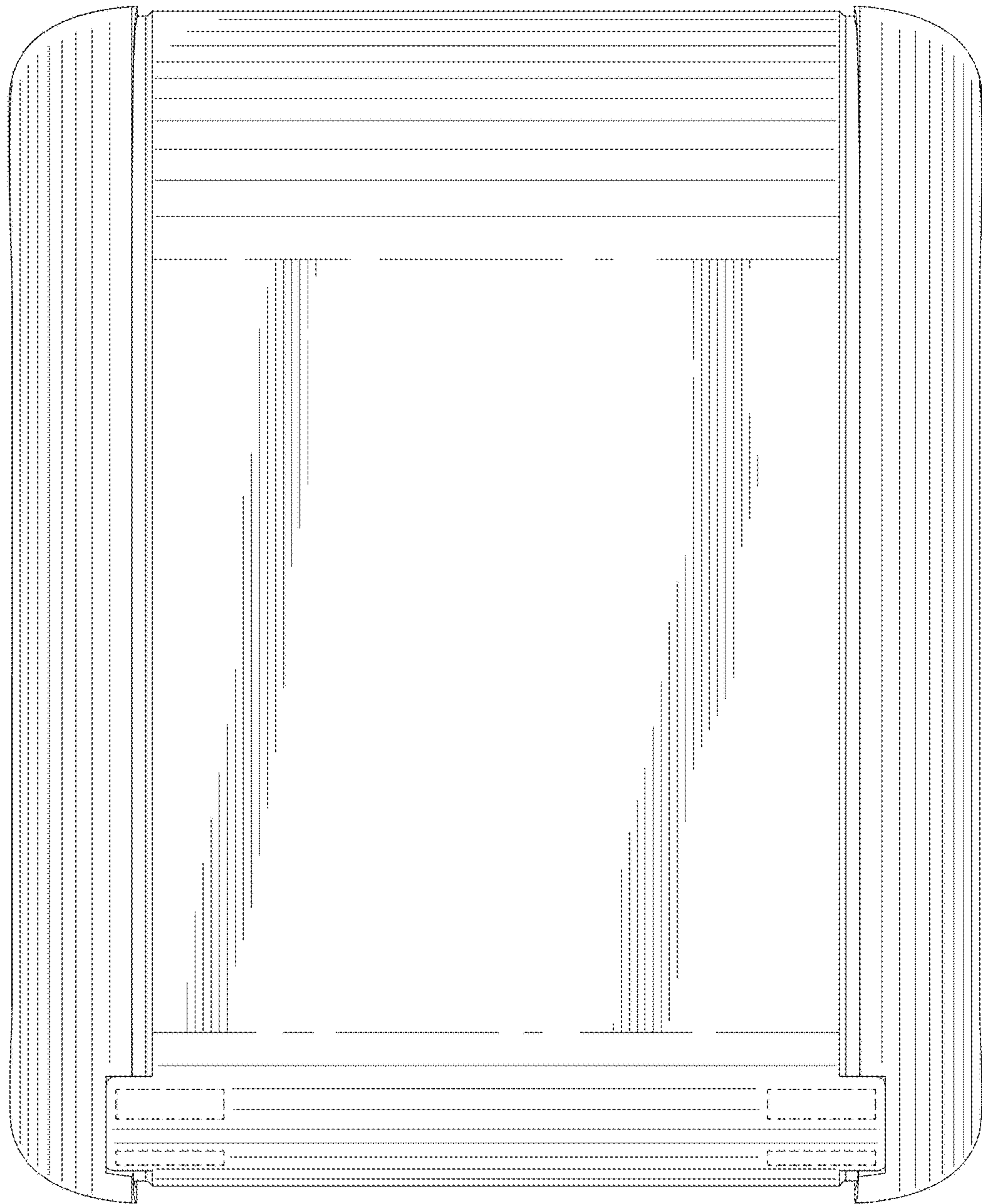

FIG. 7