



US00D820262S

(12) **United States Design Patent**
Shayani

(10) **Patent No.:** **US D820,262 S**
(45) **Date of Patent:** **** Jun. 12, 2018**

- (54) **COMPUTER MOUSE**
- (71) Applicant: **Finalmouse LLC**, New Albany, OH (US)
- (72) Inventor: **Ashkon Shayani**, New Albany, OH (US)
- (73) Assignee: **Finalmouse LLC**, New Albany, OH (US)

D711,380 S *	8/2014	Urban	D14/410
D729,804 S *	5/2015	Jost	D14/410
D762,646 S *	8/2016	Chong	D14/409
D771,046 S *	11/2016	Jost	D14/410

* cited by examiner

Primary Examiner — Austin Murphy
(74) *Attorney, Agent, or Firm* — Frank H. Foster; Kremblas & Foster

(**) Term: **15 Years**

(57) **CLAIM**

(21) Appl. No.: **29/548,551**

The ornamental design for a computer mouse, substantially as shown.

(22) Filed: **Dec. 15, 2015**

(51) **LOC (11) Cl.** **14-02**

(52) **U.S. Cl.**
USPC **D14/410**

DESCRIPTION

(58) **Field of Classification Search**
USPC D14/402-411, 356, 388, 389, 383-385, D14/417, 426; 345/156-167; 463/36-38; 358/471, 473; 273/148 B
CPC G06F 3/03543; G06F 2203/0333; G06F 3/039; G06F 3/038; G06F 2203/0384
See application file for complete search history.

FIG. 1 is a view in perspective of a computer mouse viewed from the front left quarter and showing my new design; FIG. 2 is a view in perspective thereof viewed from the rear left quarter; FIG. 3 is a view in rear elevation thereof; FIG. 4 is a top plan view thereof; FIG. 5 is a view in front elevation thereof; FIG. 6 is a view in right side elevation thereof; FIG. 7 is a view in left side elevation thereof; FIG. 8 is a bottom view thereof; FIG. 9 is a view in perspective thereof viewed from the rear left quarter; and, FIG. 10 is view in perspective thereof viewed from the front right quarter.
The broken line forms no part of the claimed design.

(56) **References Cited**

U.S. PATENT DOCUMENTS

D354,484 S *	1/1995	Skaggs	D14/410
D427,164 S *	6/2000	Slowinski	D14/410
D526,649 S *	8/2006	Pendergrass	D14/403
D527,006 S *	8/2006	Francz	D14/218
D551,667 S *	9/2007	Yahara	D14/410
D640,257 S *	6/2011	Lee	D14/410

1 Claim, 4 Drawing Sheets

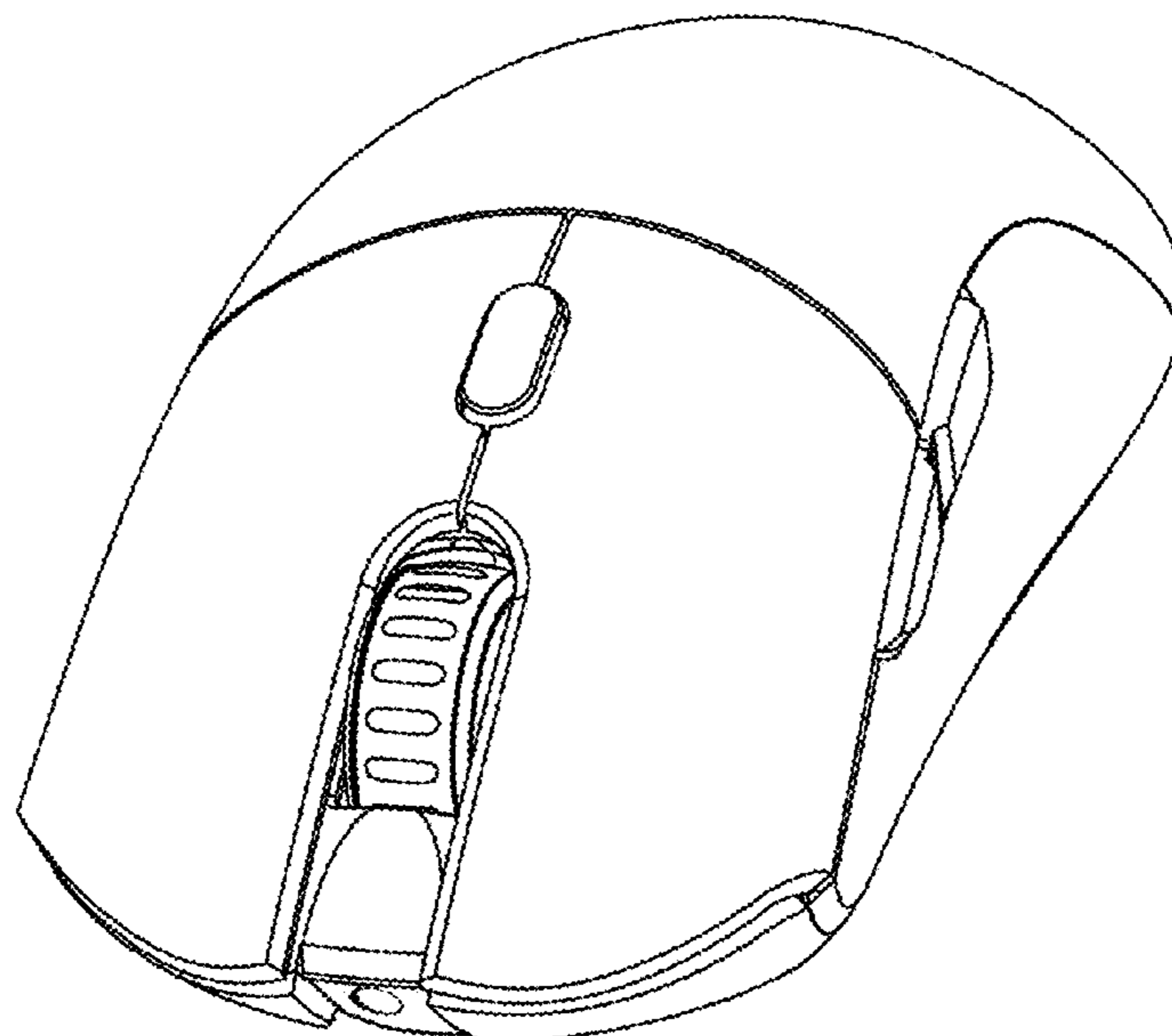

Fig. 1

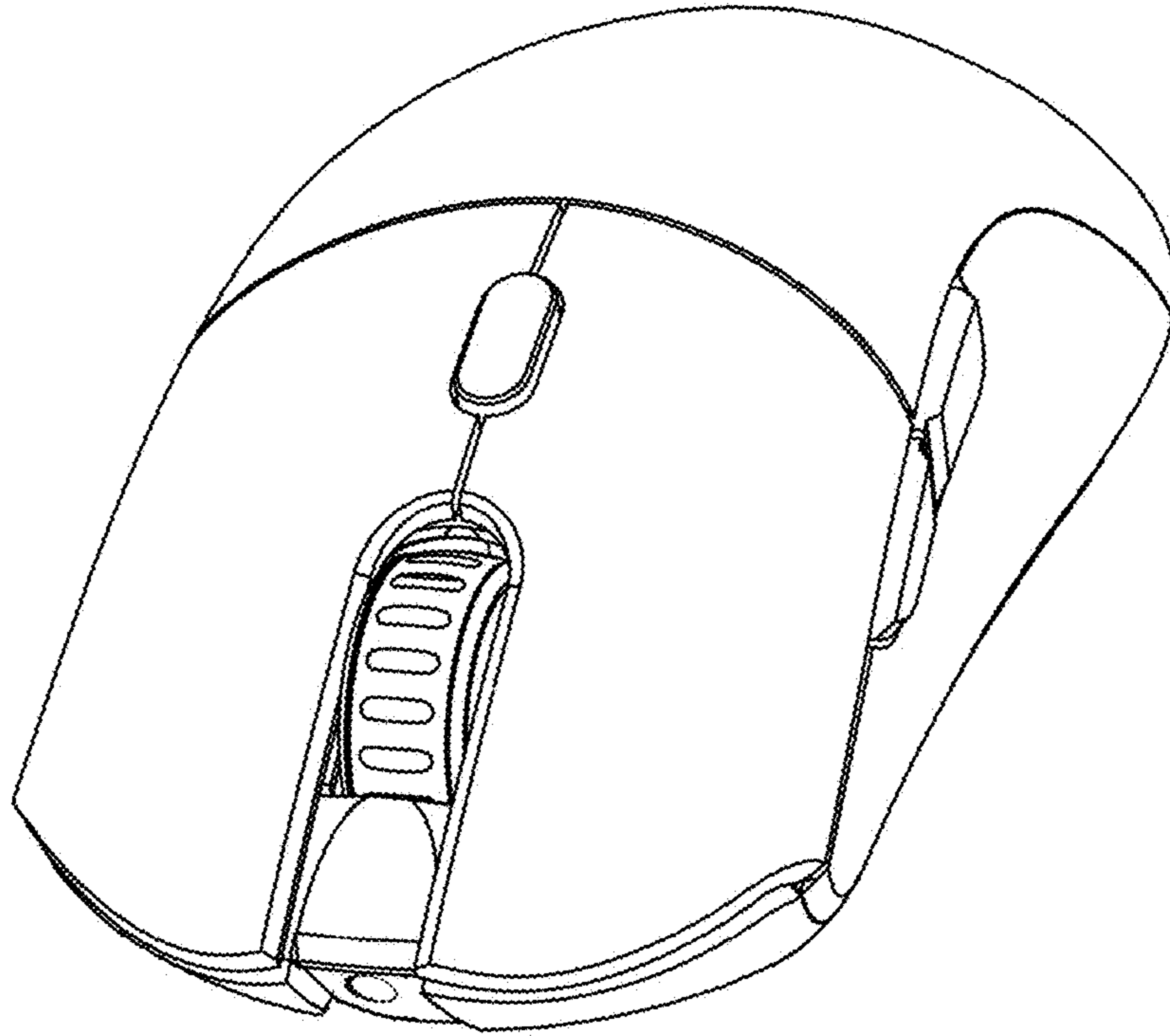

Fig. 2

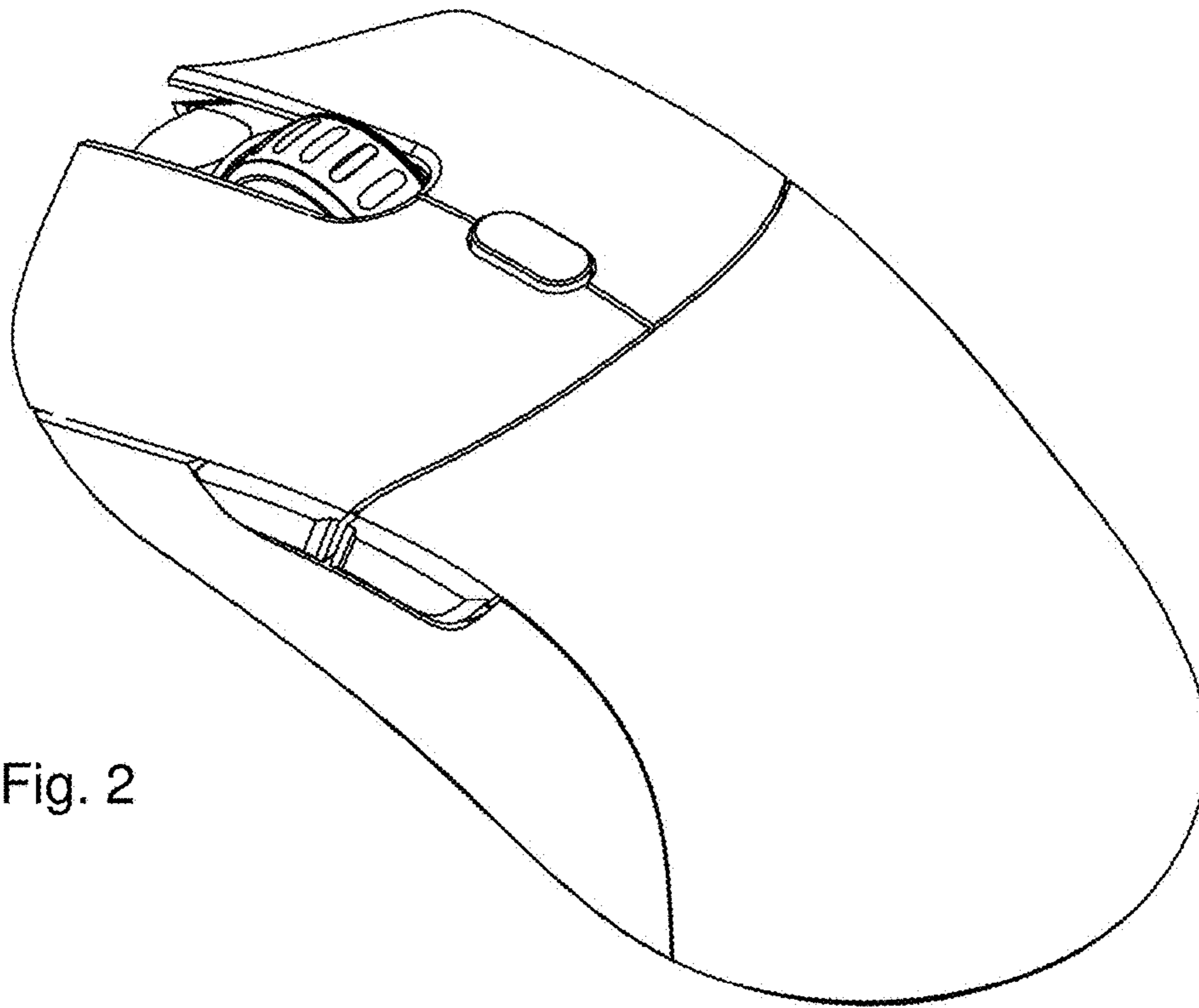

Fig. 3

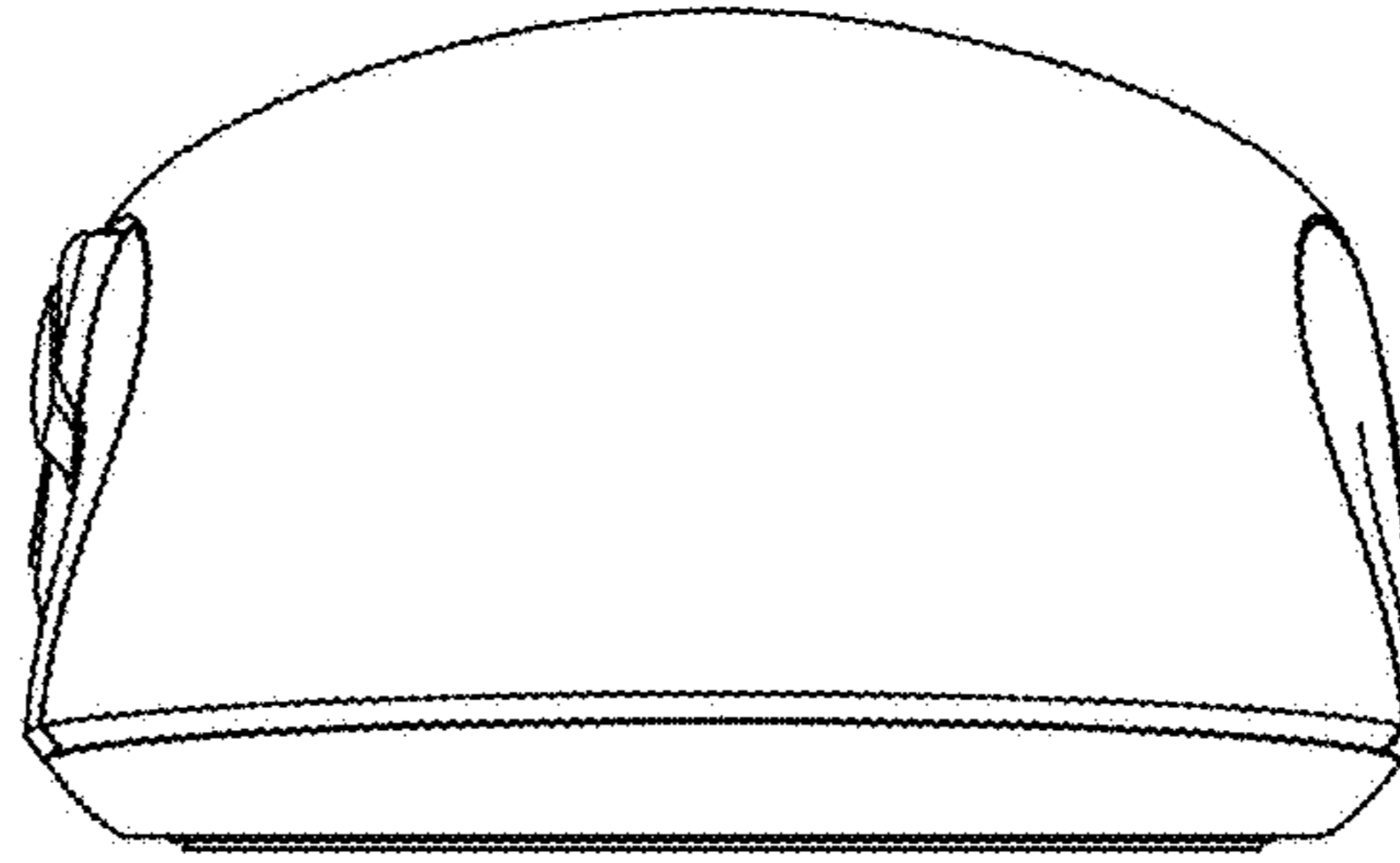

Fig. 4

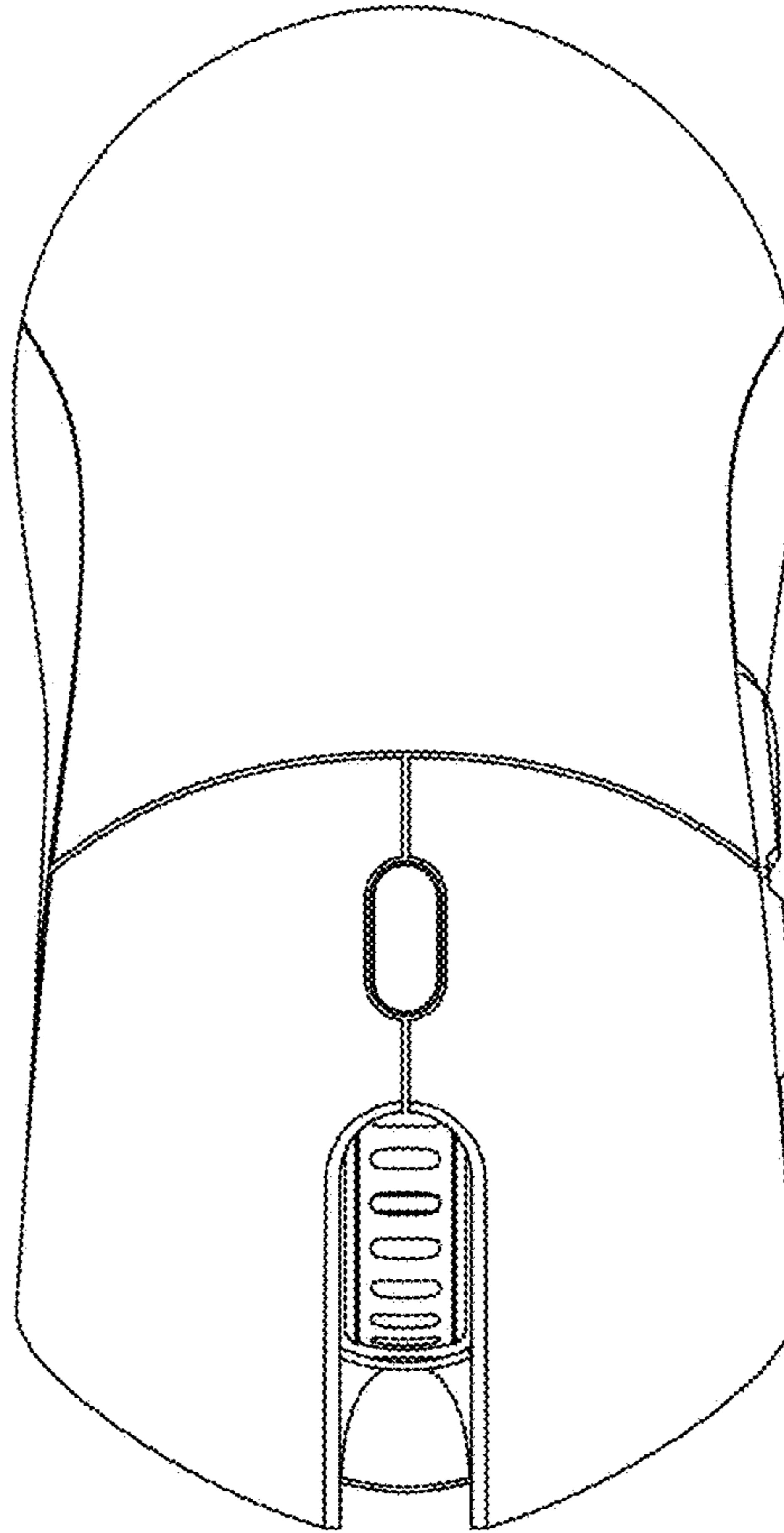

Fig. 5

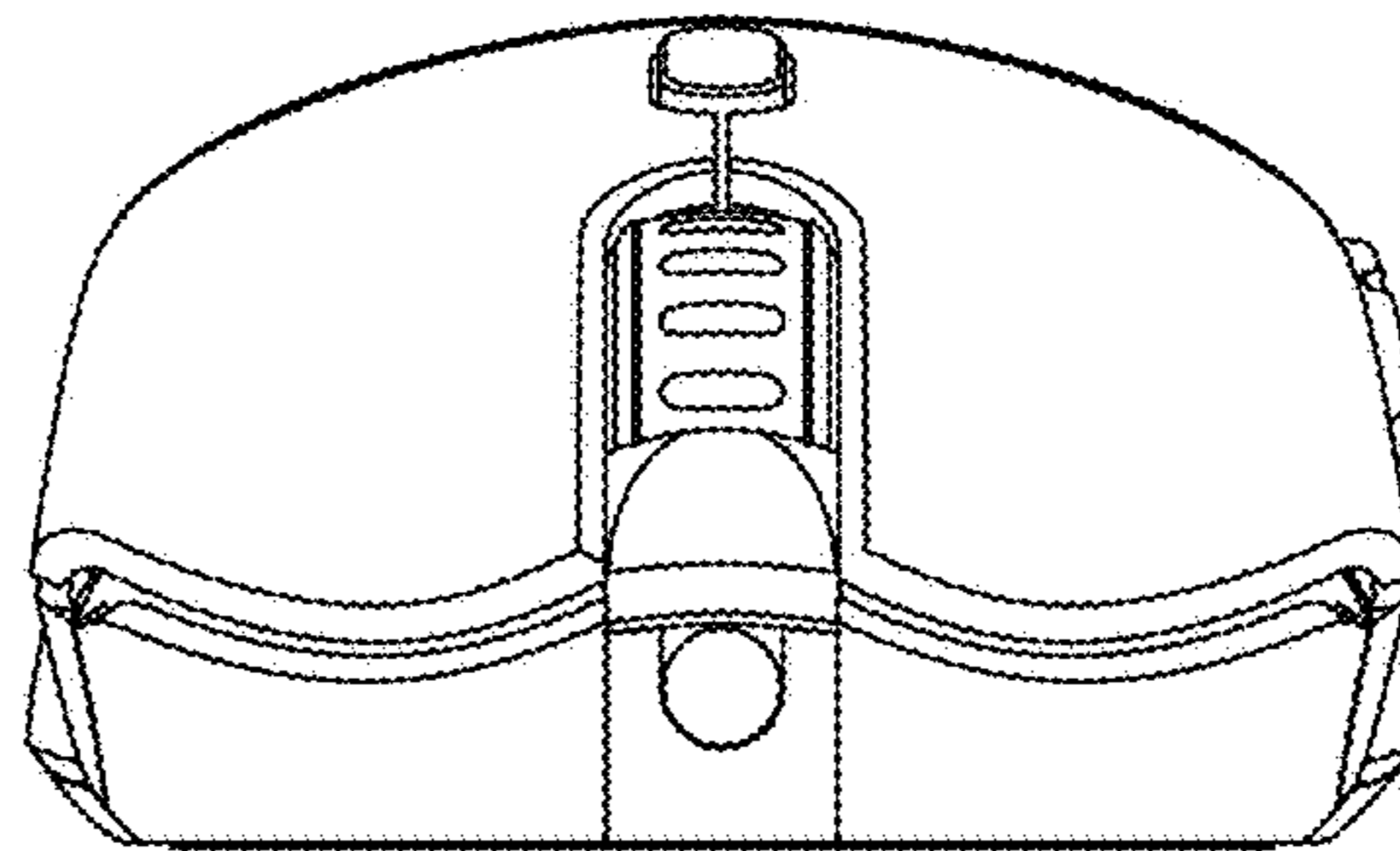

Fig. 6

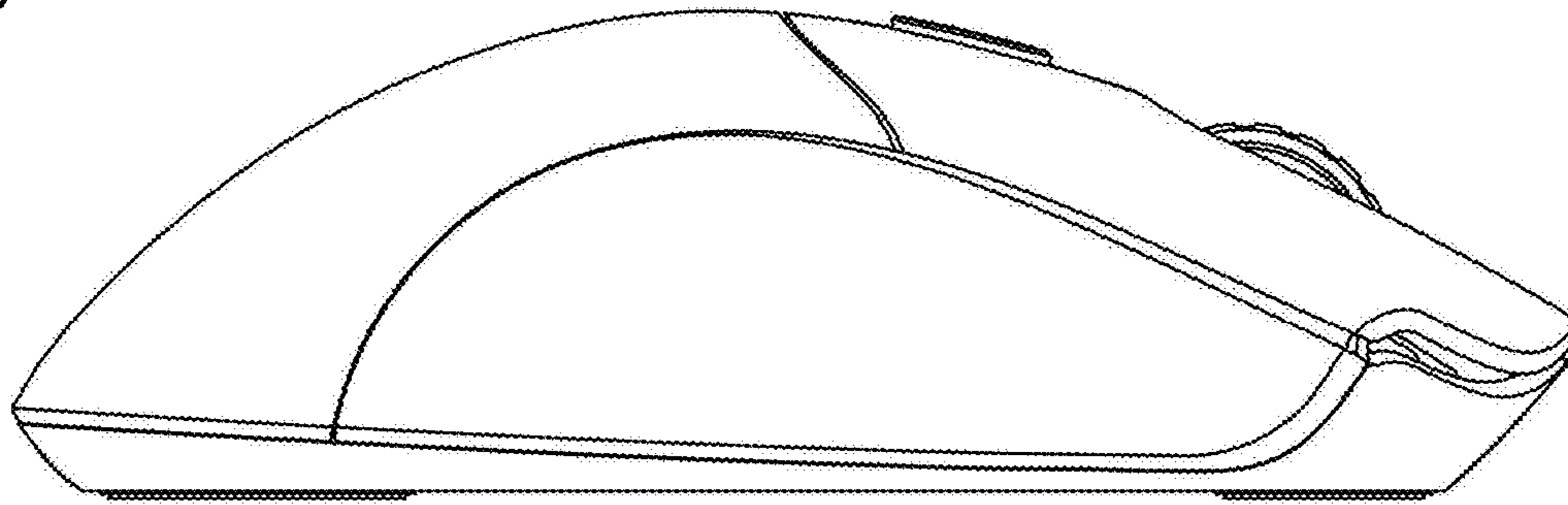

Fig. 7

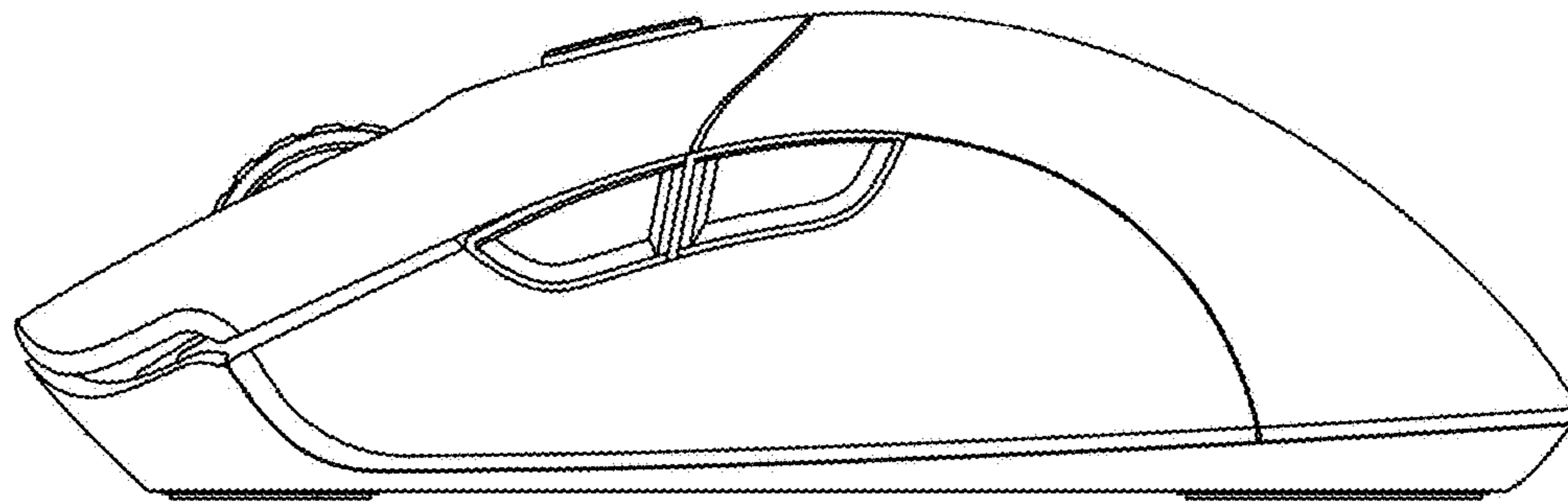

Fig. 8

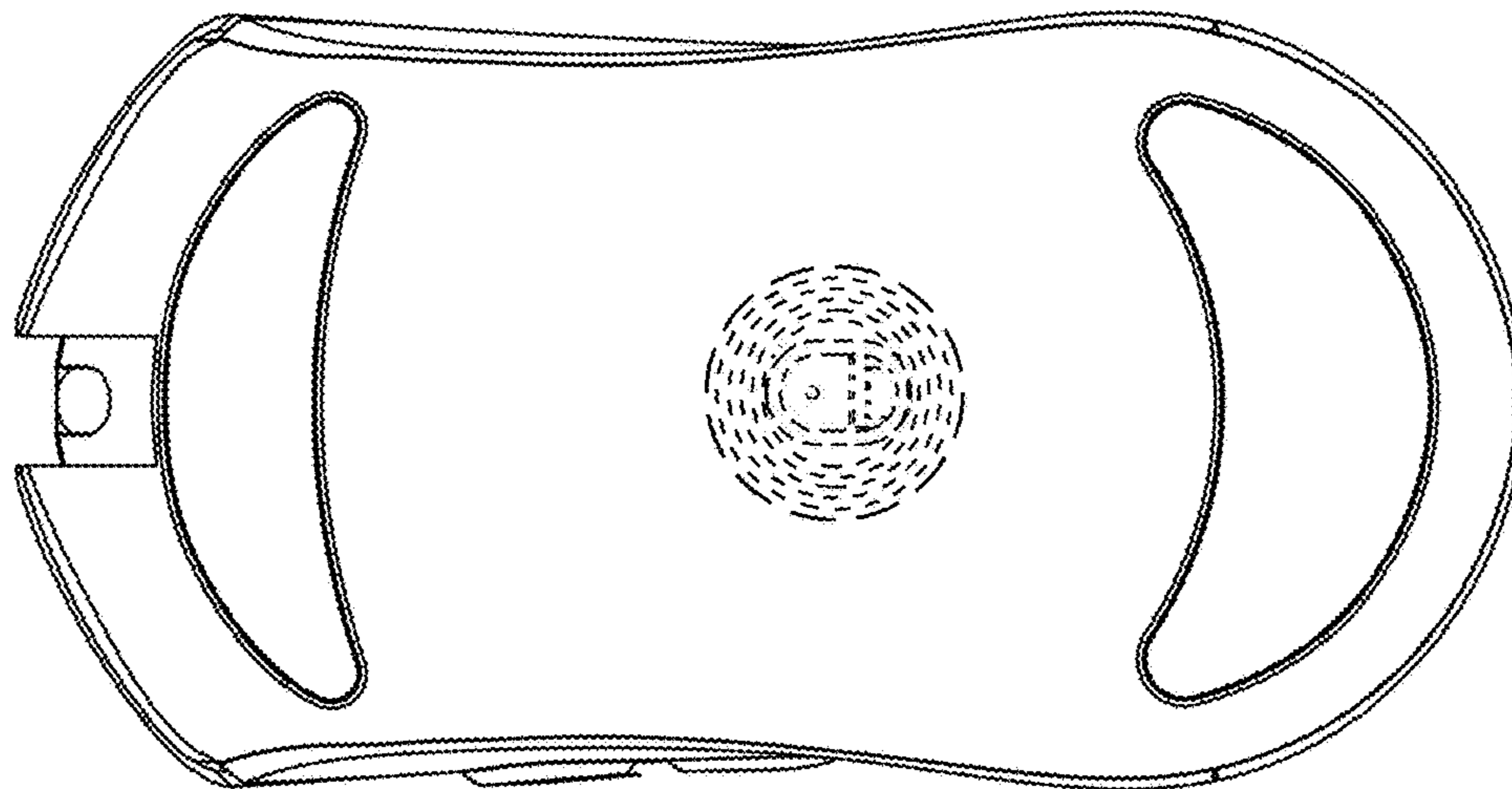

Fig. 9

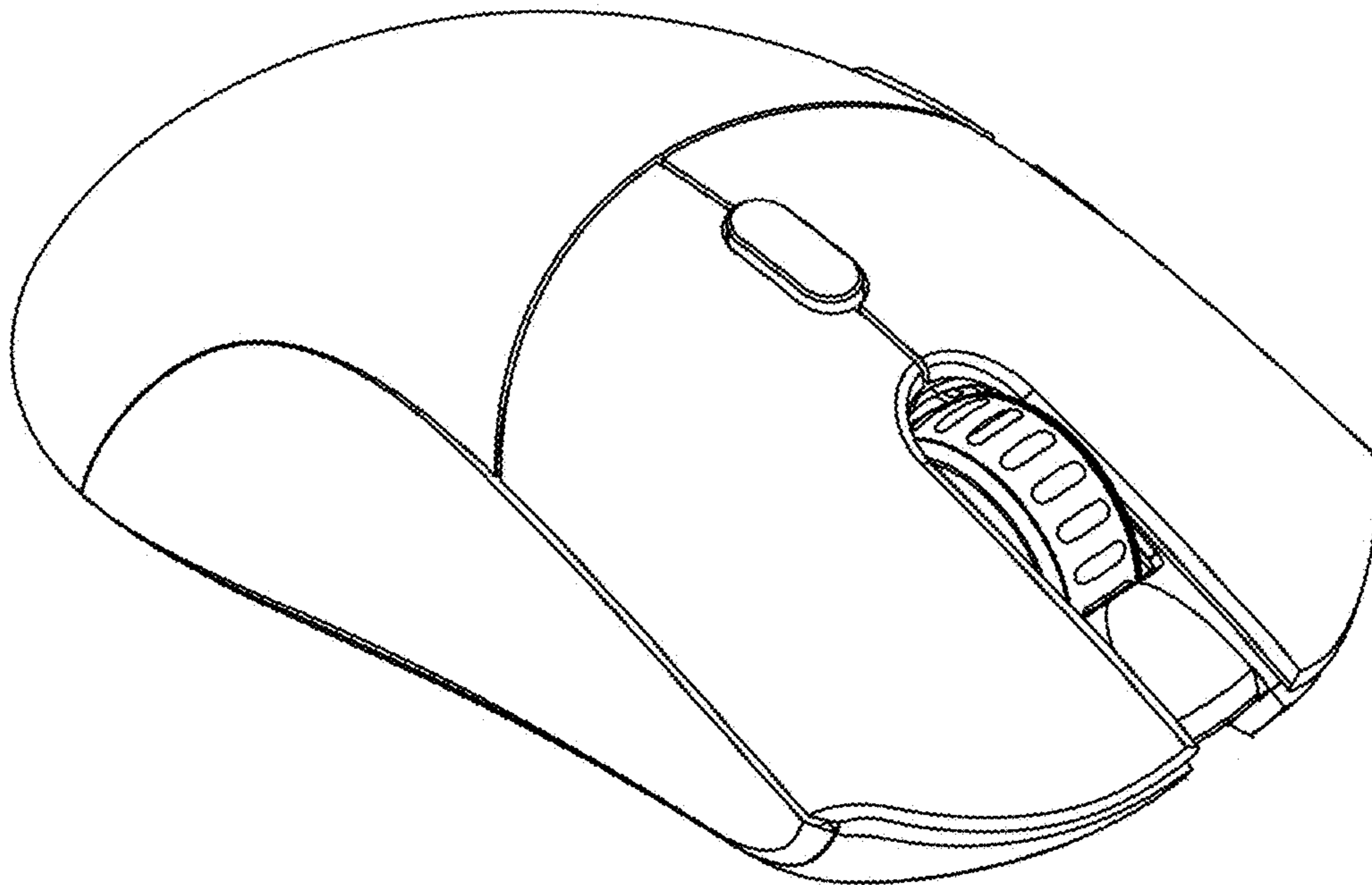
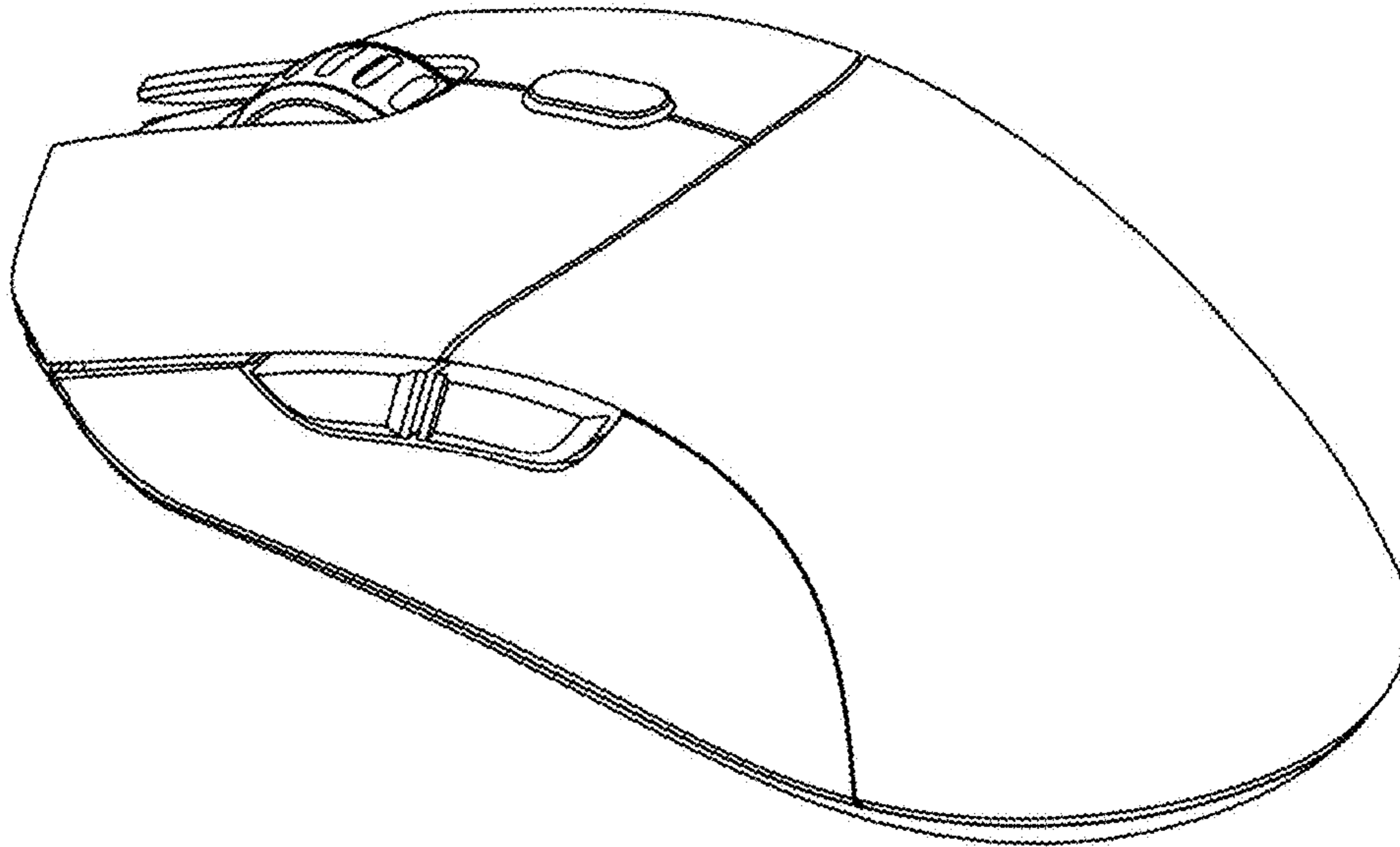

Fig. 10