

US00D820228S

(12) **United States Design Patent**
Kim et al.

(10) **Patent No.:** **US D820,228 S**
(45) **Date of Patent:** **** Jun. 12, 2018**

(54) **TV RECEIVER**

(56) **References Cited**

(71) Applicant: **LG ELECTRONICS INC.**, Seoul (KR)

U.S. PATENT DOCUMENTS

(72) Inventors: **Hyoungwon Kim**, Seoul (KR); **Sunggu Joe**, Seoul (KR)

D741,273 S *	10/2015	Huh	D14/126
D747,693 S *	1/2016	Won	D14/126
D750,582 S *	3/2016	Kim	D14/126
D773,418 S *	12/2016	Won	D14/126
D796,464 S *	9/2017	Kim	D14/126
D796,465 S *	9/2017	Kim	D14/126

(73) Assignee: **LG ELECTRONICS INC.**, Seoul (KR)

* cited by examiner

(**) Term: **15 Years**

Primary Examiner — ManPreet S Matharu

(21) Appl. No.: **35/501,773**

Assistant Examiner — Eliza Z Bennett-Hattan

(22) Filed: **Apr. 26, 2016**

(74) *Attorney, Agent, or Firm* — Birch, Stewart, Kolasch & Birch, LLP

(80) **Hague Agreement Data**

Int. Filing Date: **Apr. 26, 2016**
Int. Reg. No.: **DM/090513**
Int. Reg. Date: **Apr. 26, 2016**
Int. Reg. Pub. Date: **Oct. 28, 2016**

(57) **CLAIM**

The ornamental design for a TV receiver, as shown and described.

(30) **Foreign Application Priority Data**

Oct. 30, 2015 (KR) 30-2015-0054894

(51) **LOC (11) Cl.** **14-04**

(52) **U.S. Cl.**
USPC **D14/126**

(58) **Field of Classification Search**
USPC D14/383, 385, 387, 421, 435, 126, 358
CPC H04N 5/64; H04N 2005/4408
See application file for complete search history.

DESCRIPTION

- 1. TV receiver
- 1.1 : Perspective
- 1.2 : Front
- 1.3 : Back
- 1.4 : Left
- 1.5 : Right
- 1.6 : Top
- 1.7 : Bottom

The broken lines depict unclaimed portions of the TV receiver and form no part of the claimed design.

1 Claim, 6 Drawing Sheets

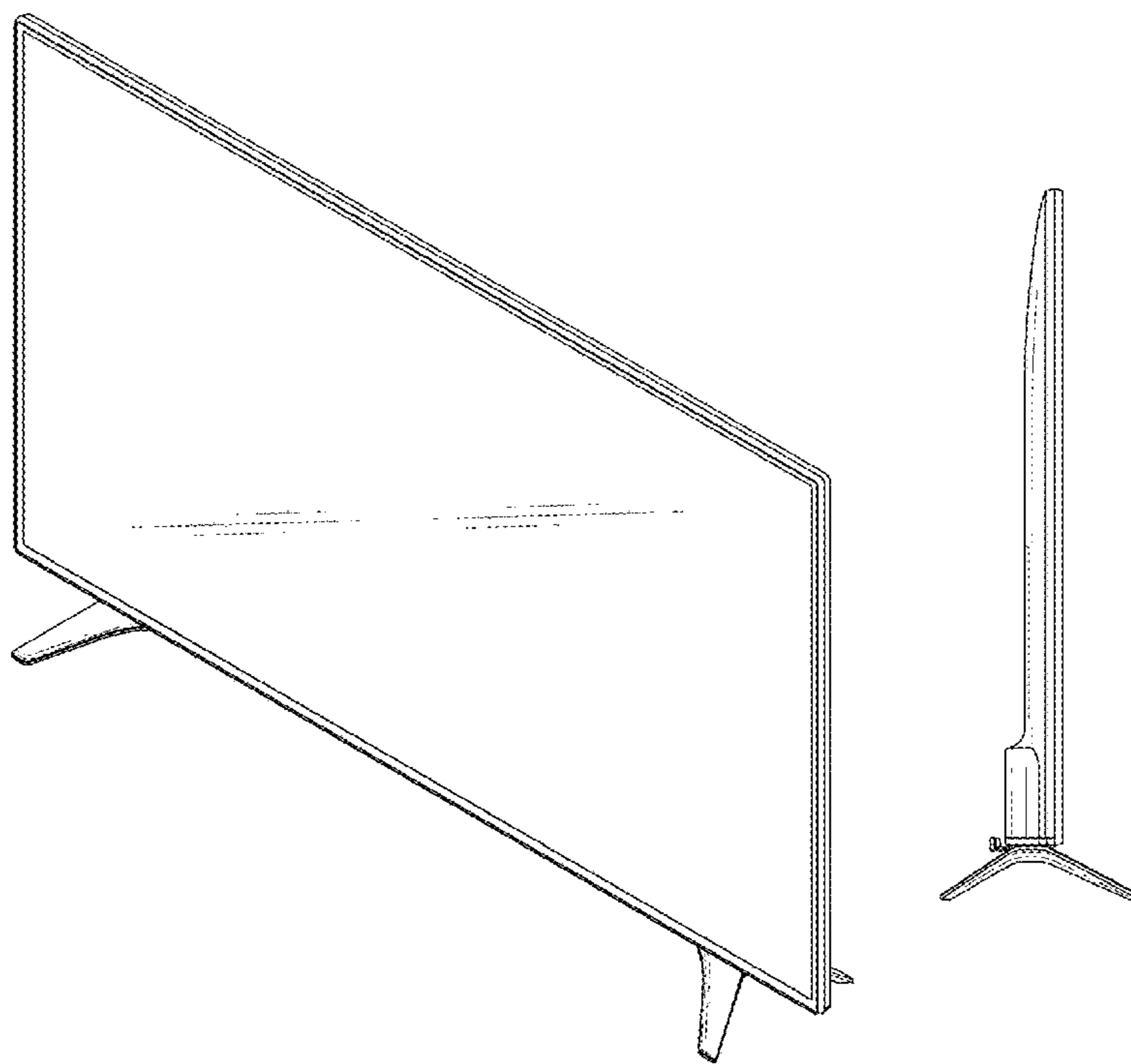

1.1

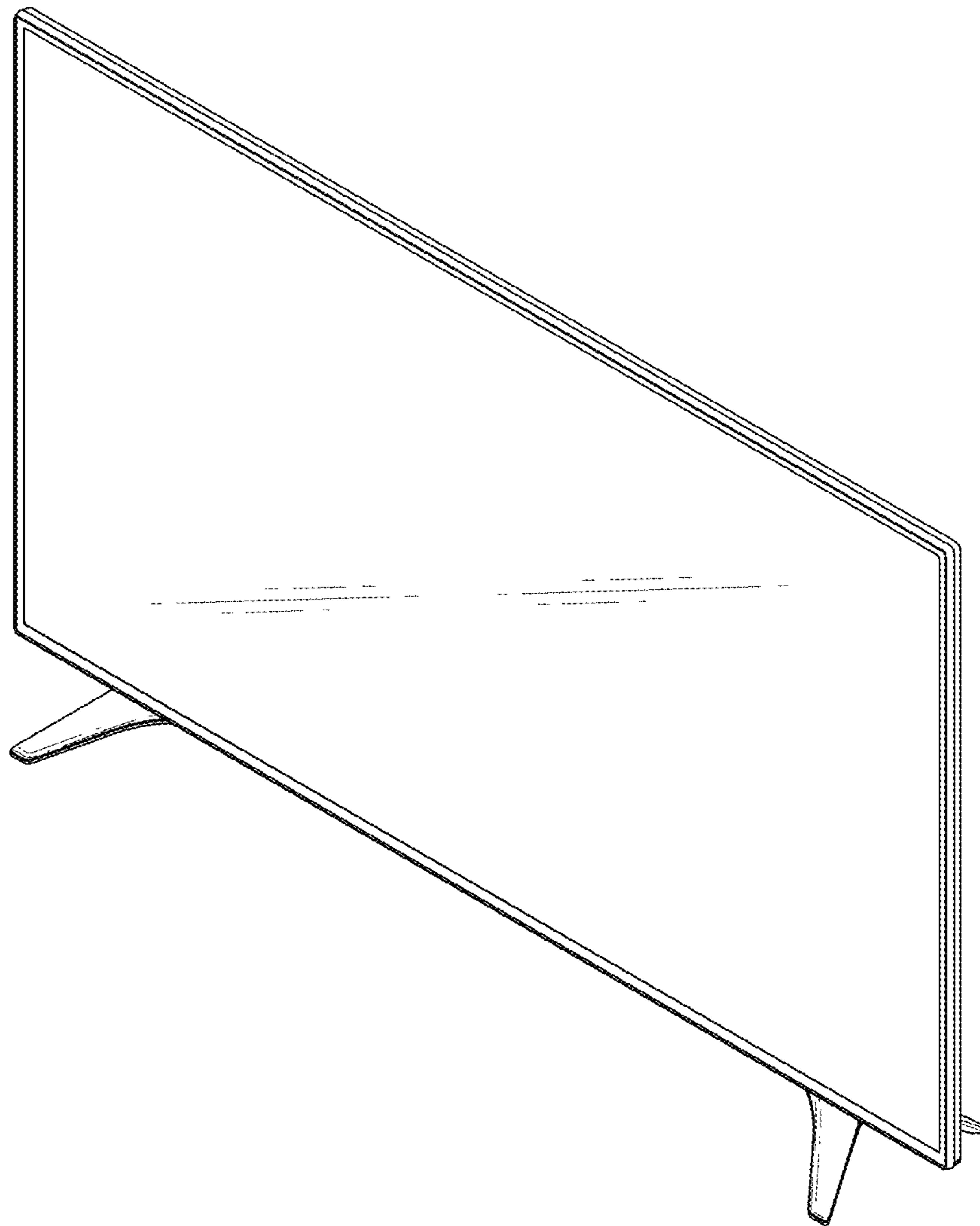

1.2

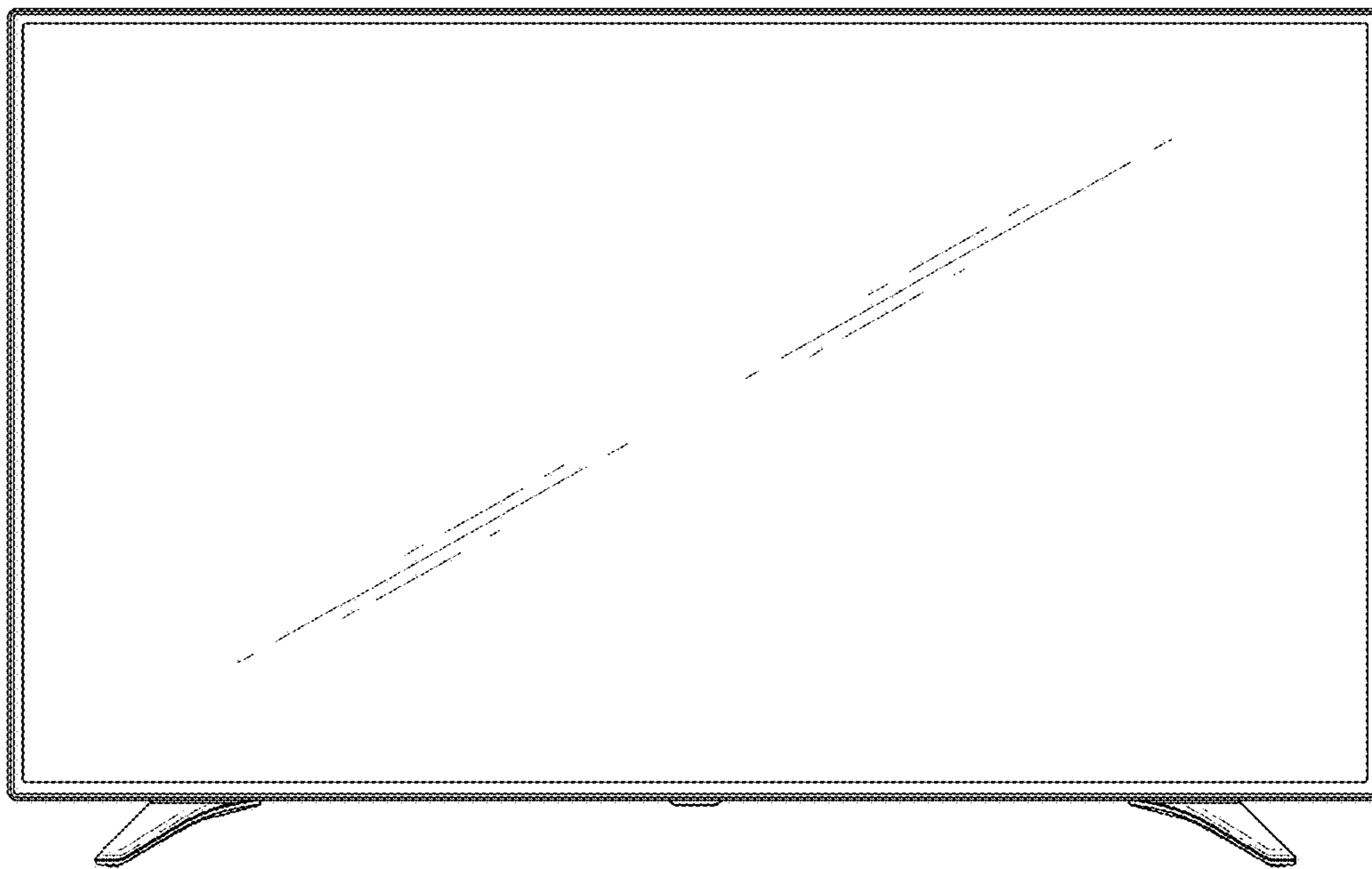

1.3

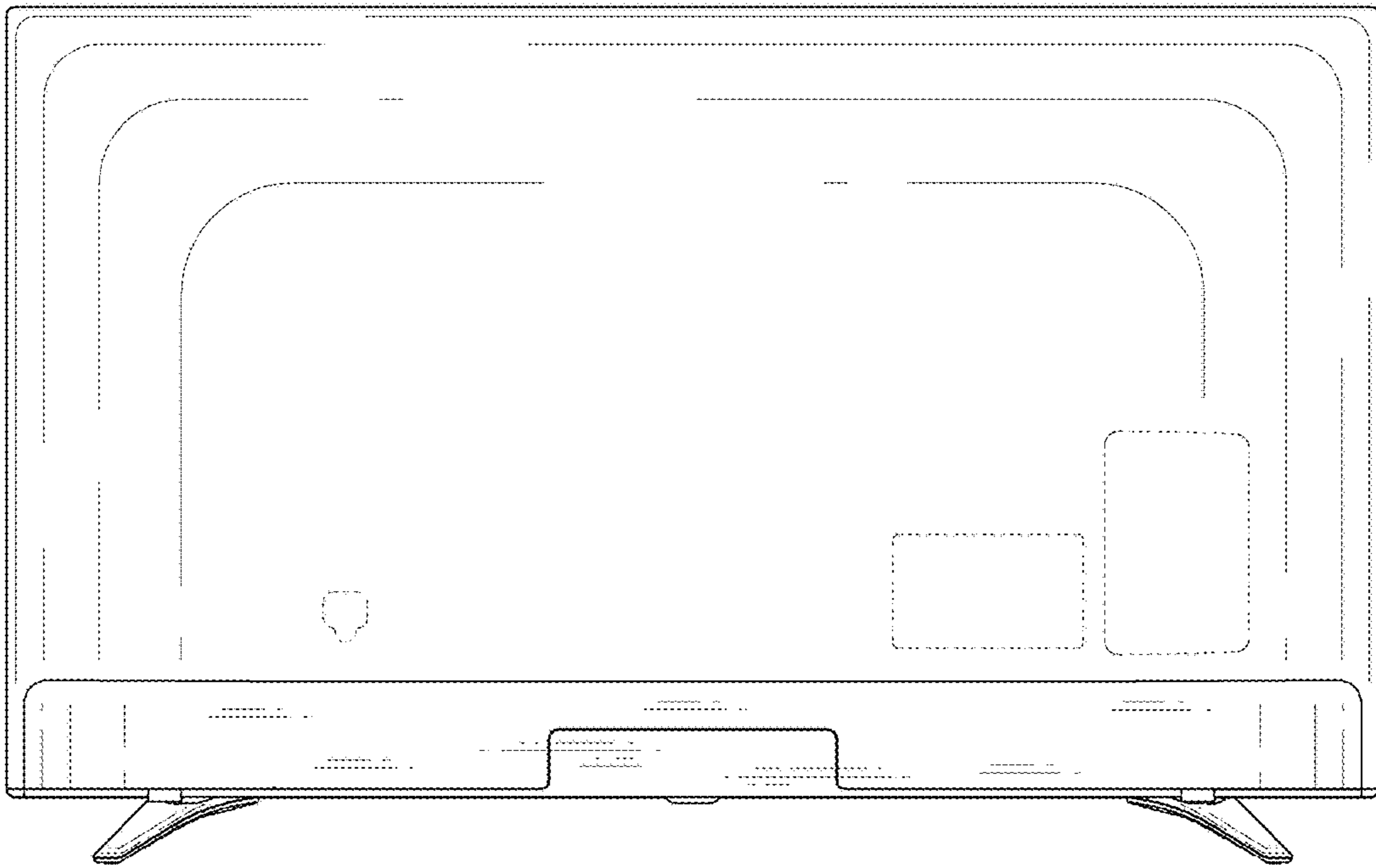

1.4

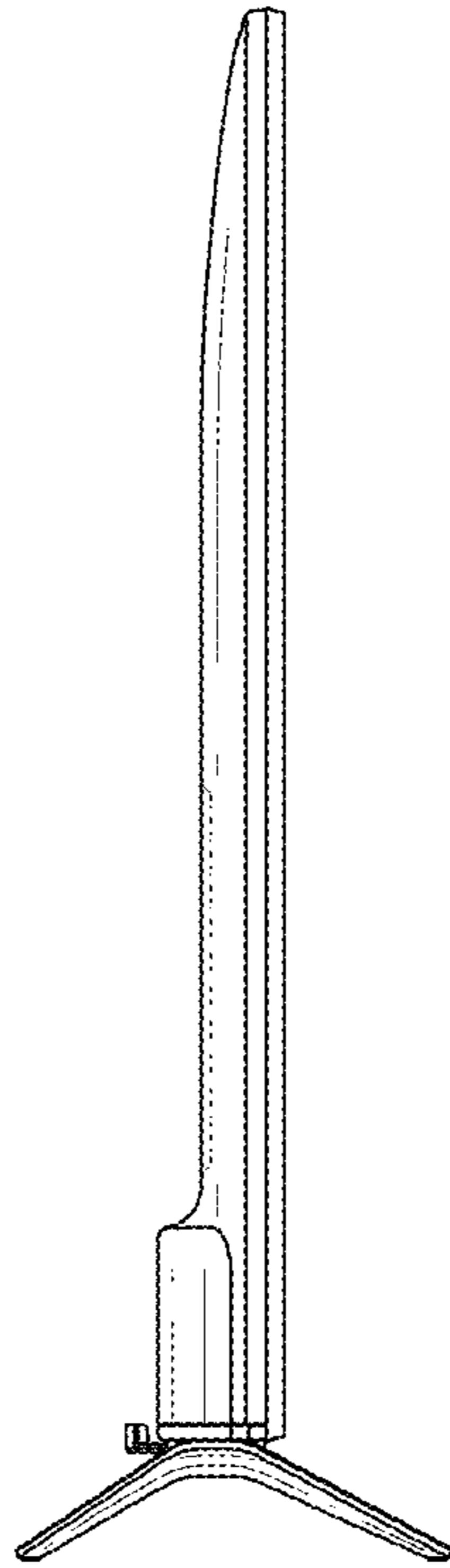

1.5

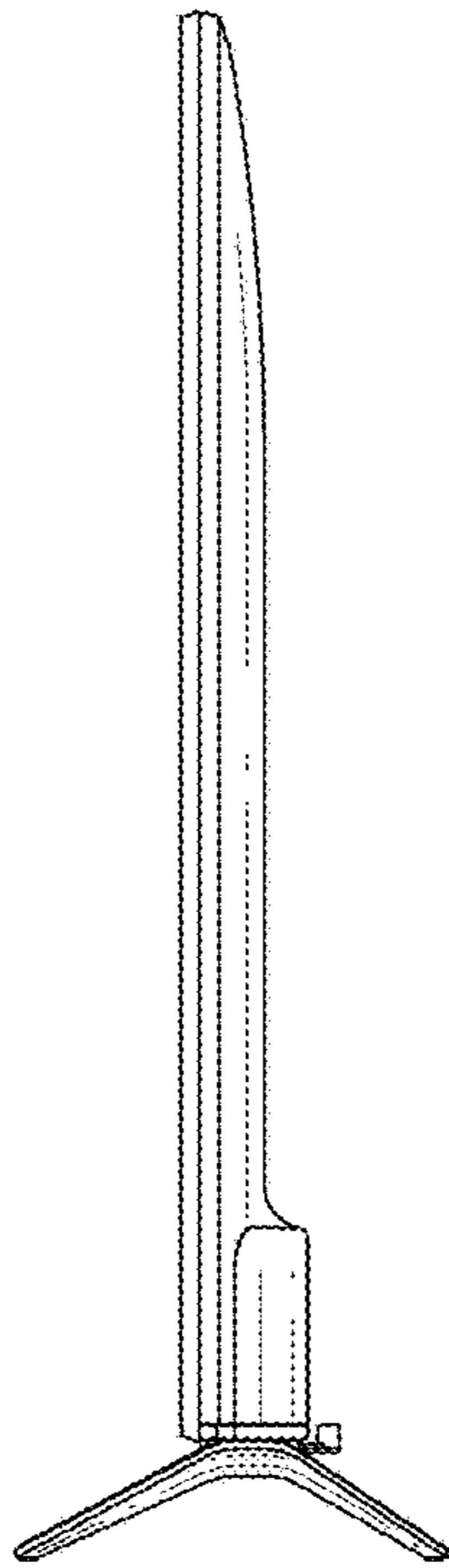

1.6

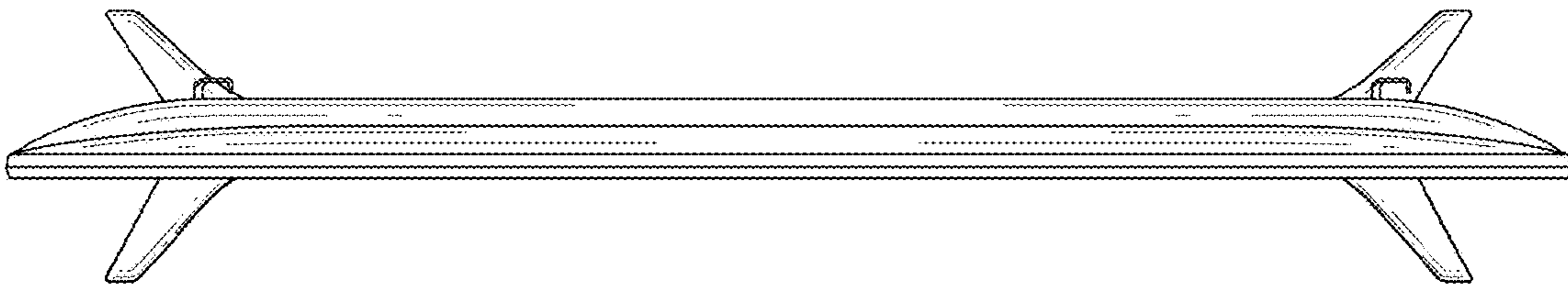

1.7

