



US00D820191S

(12) **United States Design Patent**
Farrelly

(10) **Patent No.:** **US D820,191 S**

(45) **Date of Patent:** **** Jun. 12, 2018**

(54) **VEHICLE CAB COVER WITH LOGO**

(71) Applicant: **Ray Farrelly**, Osseo, MN (US)

(72) Inventor: **Ray Farrelly**, Osseo, MN (US)

(**) Term: **15 Years**

(21) Appl. No.: **29/608,719**

(22) Filed: **Jun. 25, 2017**

(51) **LOC (11) Cl.** **12-16**

(52) **U.S. Cl.**
USPC **D12/401**

(58) **Field of Classification Search**
USPC D12/401, 402-405; D6/610, 611, 596,
D6/601-603, 615, 617, 621
CPC E04H 15/06; B62J 19/00; B62J 1/18; B62J
1/26; B62J 1/24; B62J 1/28; B62J 1/22
See application file for complete search history.

(56) **References Cited**

U.S. PATENT DOCUMENTS

D496,322 S *	9/2004	Farney	D12/401
D509,257 S *	9/2005	Yamamoto	D21/398
D540,245 S *	4/2007	Gupta	D12/401
D621,777 S *	8/2010	Shmul	D12/401

D623,582 S *	9/2010	Smith	D12/401
D637,134 S *	5/2011	Kaiser	D12/318
D694,169 S *	11/2013	Fontanilla	D12/401
D705,157 S *	5/2014	Madison	D12/401
D724,519 S *	3/2015	Baker	D12/401
D728,451 S *	5/2015	Rodriguez	D12/401
D746,216 S *	12/2015	Holeman	D12/401

* cited by examiner

Primary Examiner — Katrina A Betton
(74) *Attorney, Agent, or Firm* — RG Patent Consulting, LLC; Rachel Gilboy

(57) **CLAIM**

The ornamental design for a vehicle cab cover with logo, as shown and described.

DESCRIPTION

FIG. 1 is a perspective view of the vehicle cab cover with logo showing my new design;
FIG. 2 is a bottom plan view thereof;
FIG. 3 is a top plan view thereof;
FIG. 4 is a left elevation view thereof;
FIG. 5 is a right elevation view thereof;
FIG. 6 is a front elevation view thereof; and,
FIG. 7 is a rear elevation view thereof.
Broken lines are included for depicting environmental subject matter and form no part of the claimed design.

1 Claim, 3 Drawing Sheets

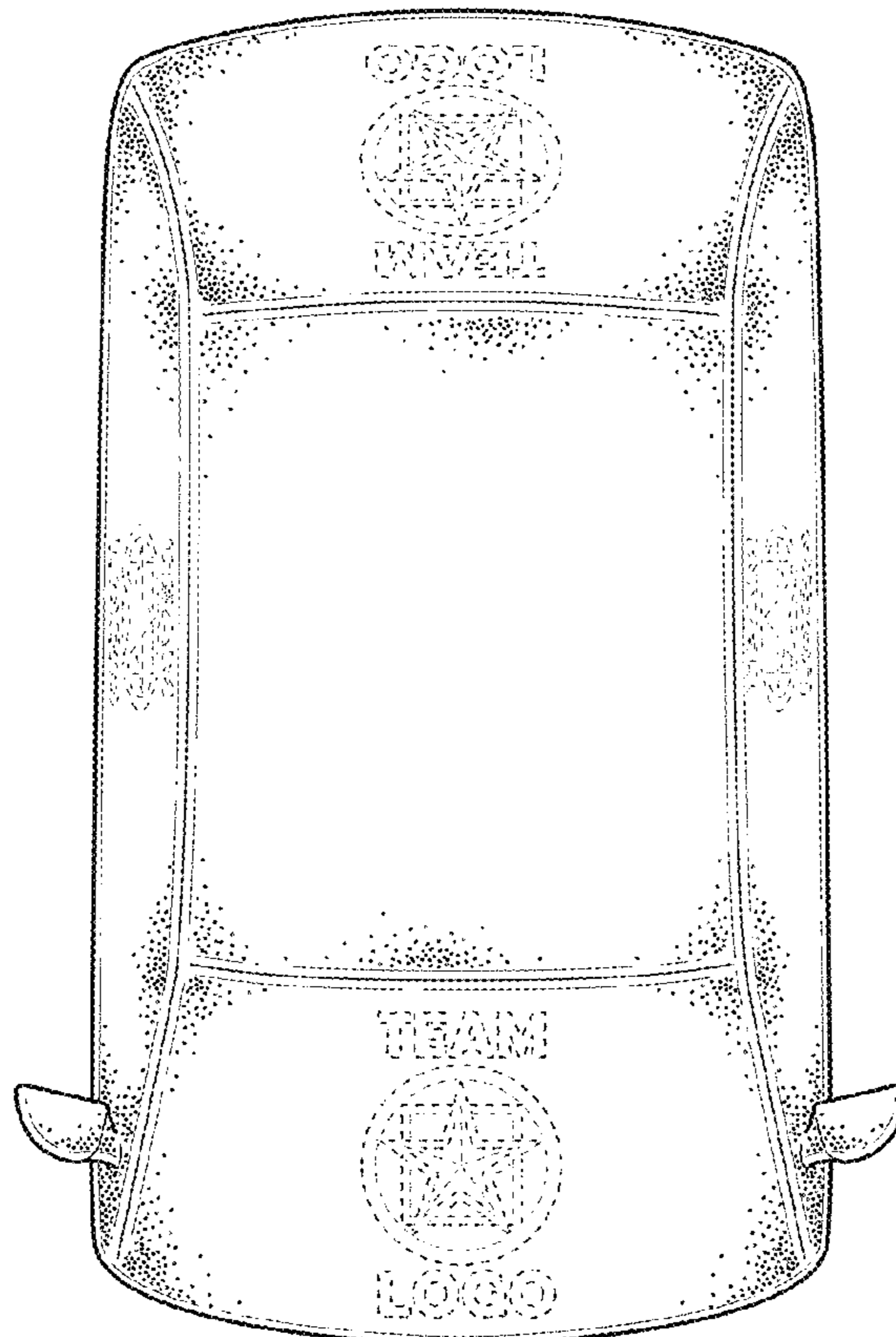

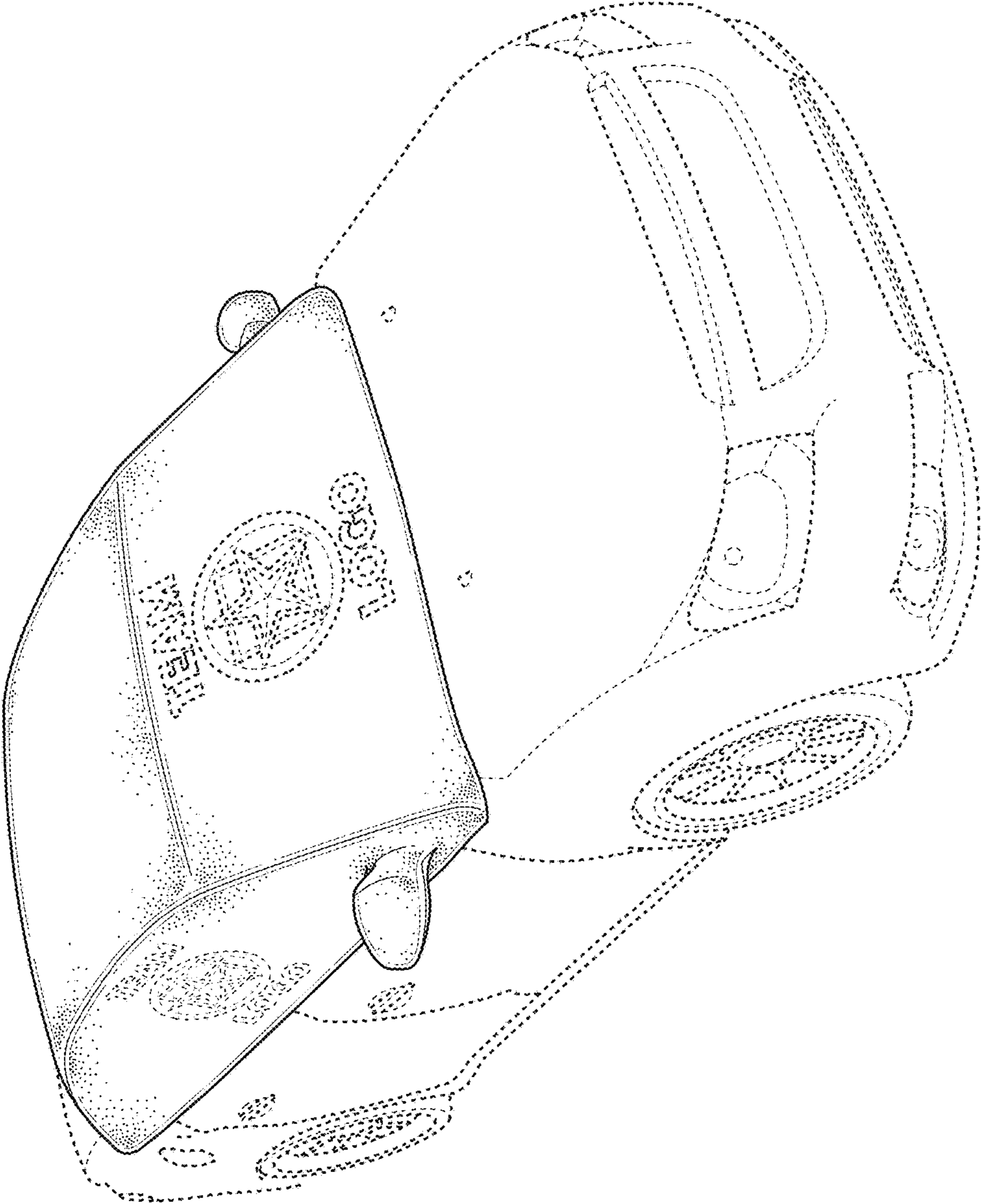

FIG. 1

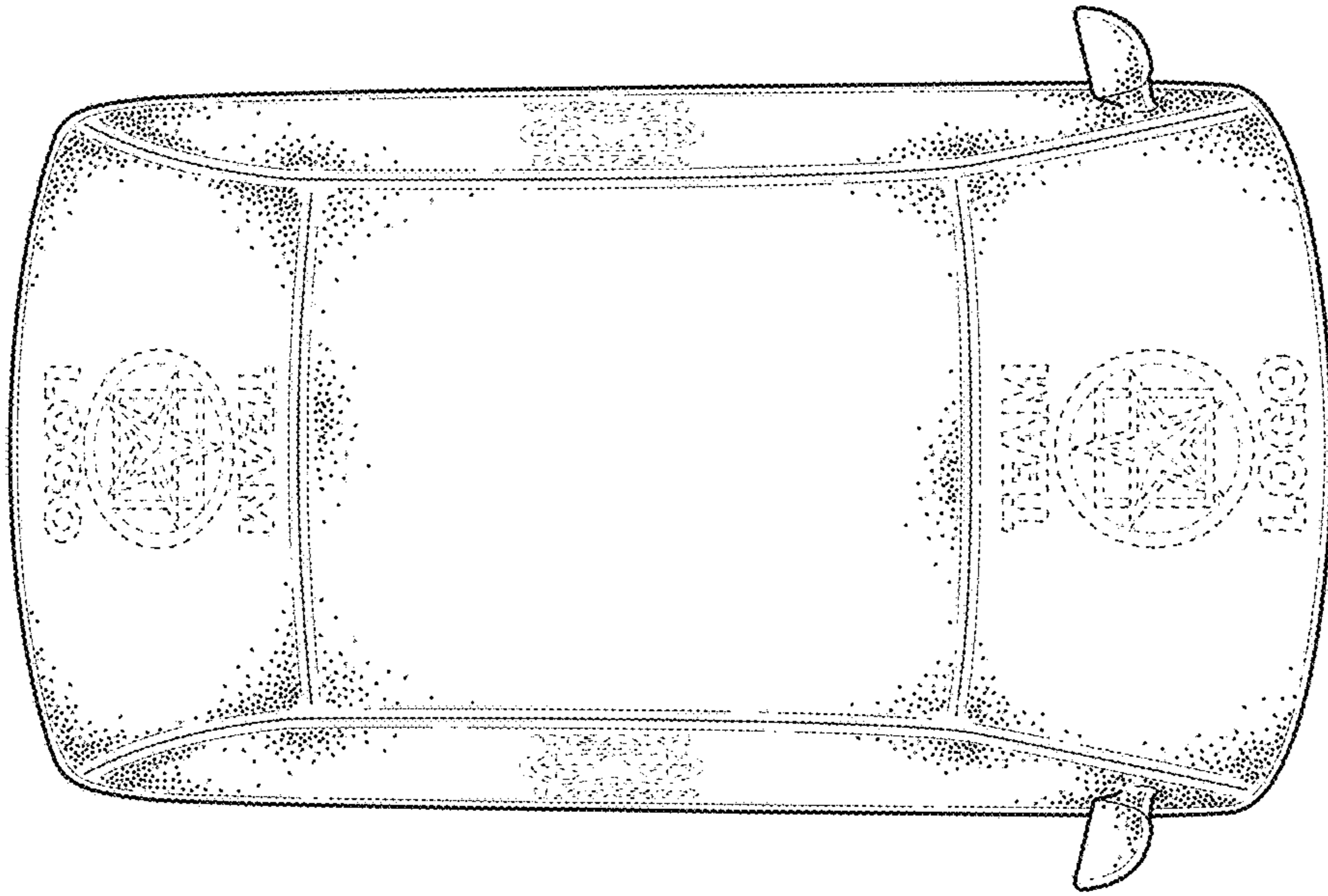

FIG. 3

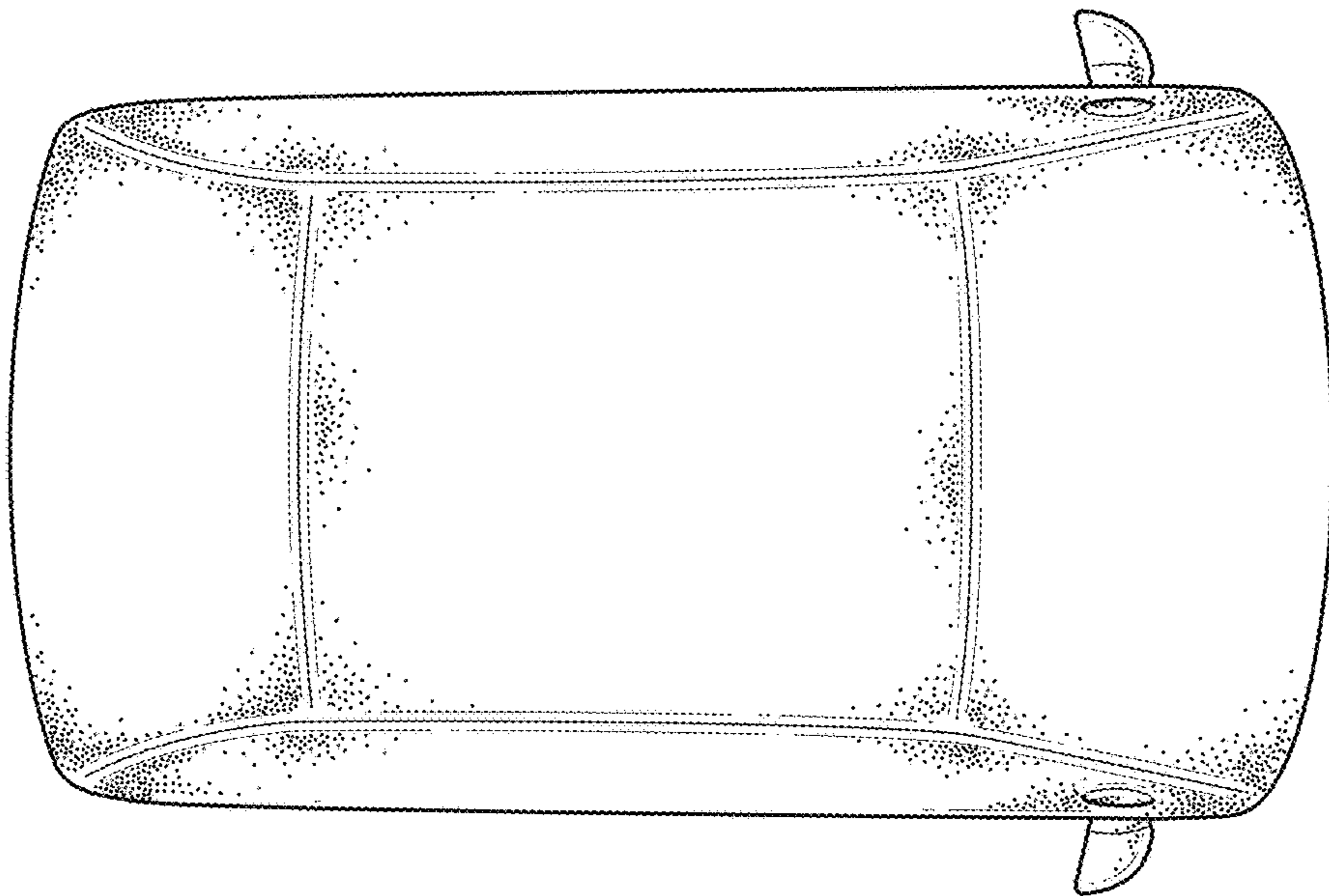

FIG. 2

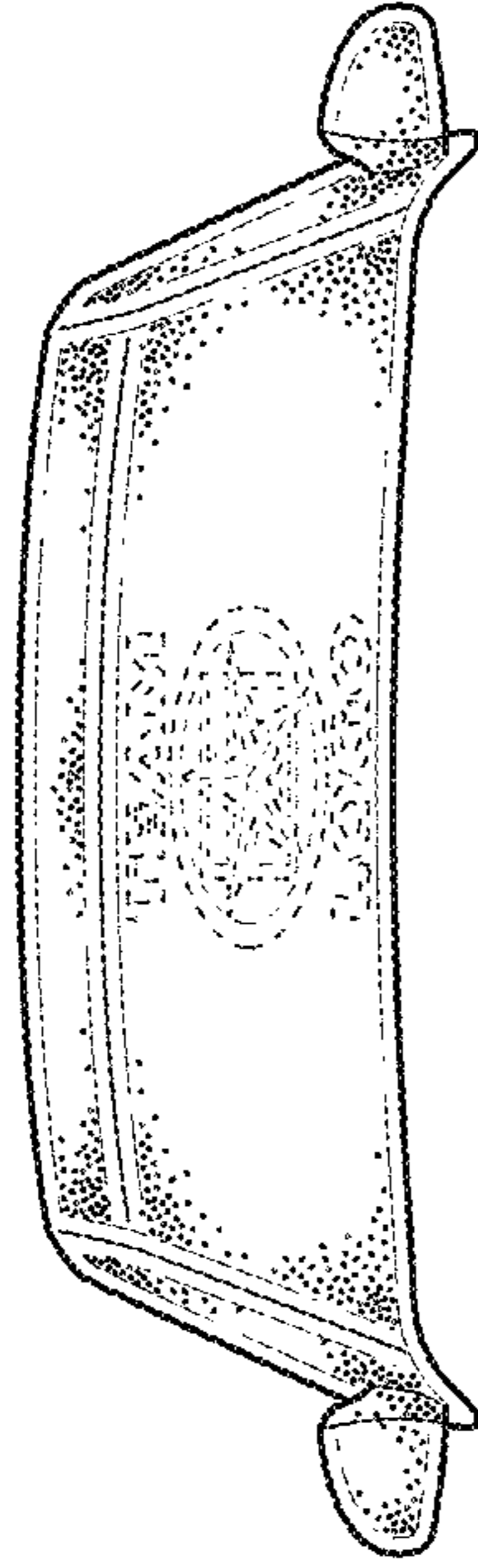

FIG. 6

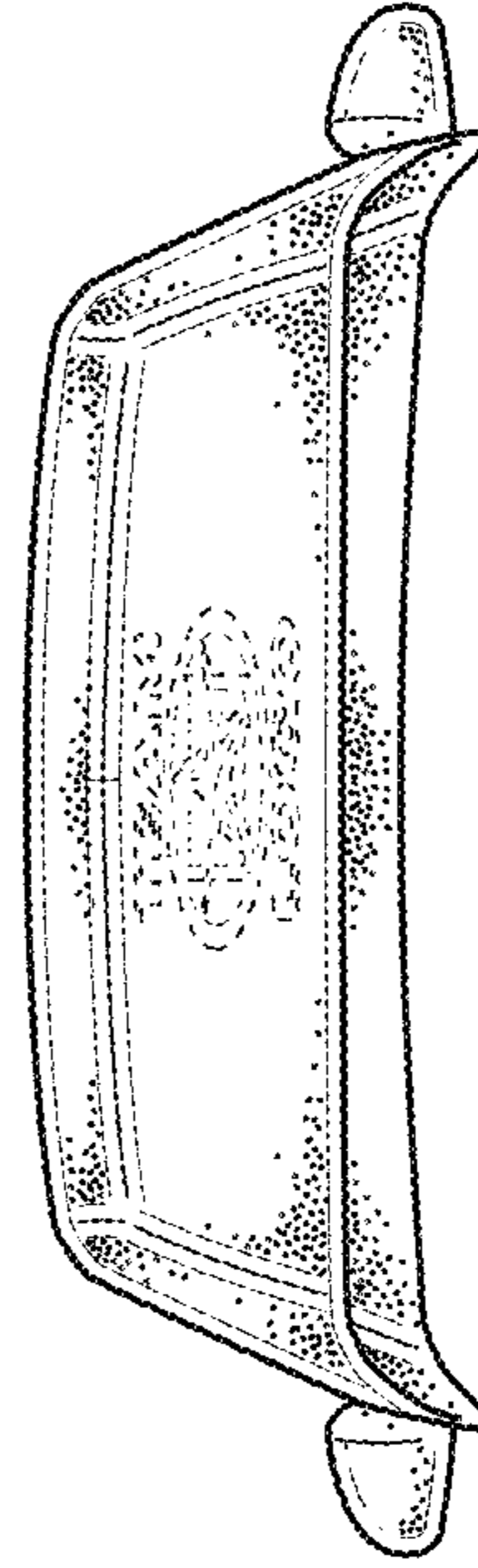

FIG. 7

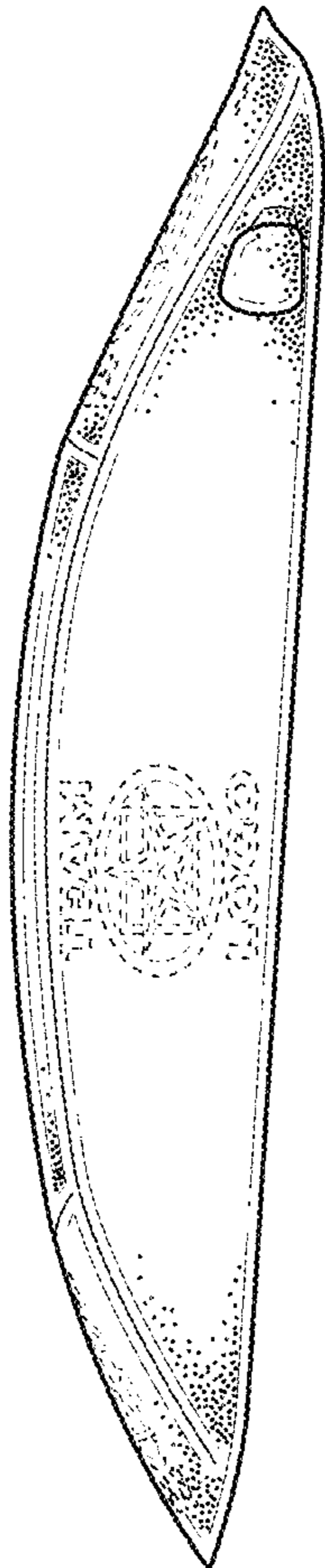

FIG. 4

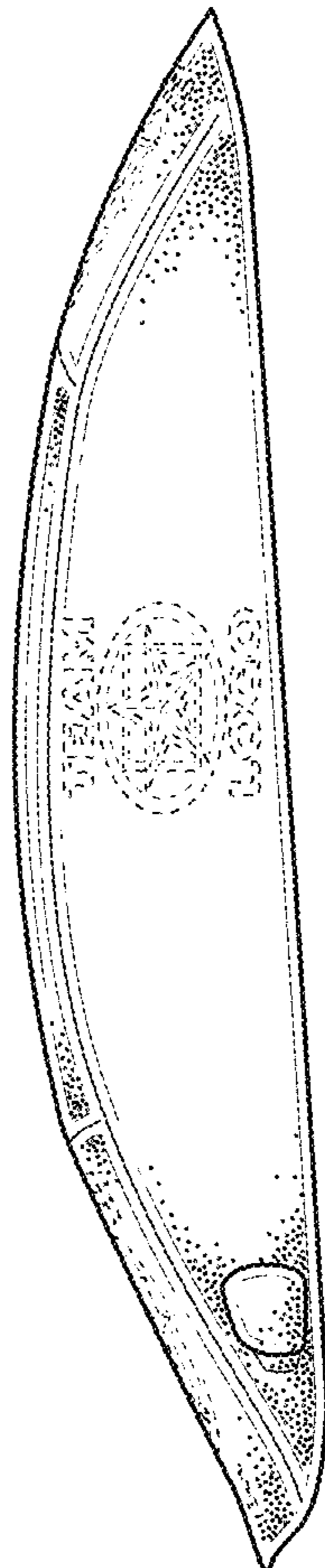

FIG. 5