



US00D819754S

(12) **United States Design Patent** (10) **Patent No.:** **US D819,754 S**  
**Gillenwater** (45) **Date of Patent:** **\*\* Jun. 5, 2018**

(54) **TOY DINOSAUR SET**

(71) Applicant: **Jill Kiplyn Gillenwater**, Cathedral City, CA (US)

(72) Inventor: **Jill Kiplyn Gillenwater**, Cathedral City, CA (US)

(\*\*) Term: **15 Years**

(21) Appl. No.: **29/593,650**

(22) Filed: **Feb. 10, 2017**

(51) **LOC (11) Cl.** ..... **21-01**

(52) **U.S. Cl.**  
USPC ..... **D21/615; D21/592; D21/590**

(58) **Field of Classification Search**  
USPC ..... **D6/598; D11/158, 159, 162; D21/576-595, 615; 446/73, 97, 368-369, 446/376; 180/8.6; D30/160**

(Continued)

(56) **References Cited**

**U.S. PATENT DOCUMENTS**

D244,953 S \* 7/1977 McMahon ..... D21/592  
D244,954 S \* 7/1977 McMahon ..... D21/592

(Continued)

**OTHER PUBLICATIONS**

PlanToys Dino Cars, dated Sep. 22, 2014. <https://inhabitat.com/inhabitots/plantoy-dino-cars-make-boredom-extinct/>\*

*Primary Examiner* — Sandra L Morris

(74) *Attorney, Agent, or Firm* — Mestechkin Law Group PC

(57) **CLAIM**

The ornamental design for the toy dinosaur set, as shown and described.

**DESCRIPTION**

FIG. 1 is a top front isometric view of the toy dinosaur set according to my new design;

FIG. 2 is a front view thereof;  
FIG. 3 is a top left isometric view of the first toy dinosaur, shown broken away for ease of illustration;  
FIG. 4 is a bottom right rear isometric view thereof;  
FIG. 5 is a front view thereof;  
FIG. 6 is a rear view thereof;  
FIG. 7 is a right side view thereof;  
FIG. 8 is a left side view thereof;  
FIG. 9 is a top view thereof;  
FIG. 10 is a bottom view thereof;  
FIG. 11 is a top left isometric view of the second toy dinosaur of the toy dinosaur set, shown broken away for ease of illustration;  
FIG. 12 is a bottom right rear isometric view thereof;  
FIG. 13 is a front view thereof;  
FIG. 14 is a rear view thereof;  
FIG. 15 is a right side view thereof;  
FIG. 16 is a left side view thereof;  
FIG. 17 is a top view thereof;  
FIG. 18 is a bottom view thereof;  
FIG. 19 is a top left isometric view of the third toy dinosaur of the toy dinosaur set, shown broken away for ease of illustration;  
FIG. 20 is a bottom left rear isometric view thereof;  
FIG. 21 is a front view thereof;  
FIG. 22 is a rear view thereof;  
FIG. 23 is a right side view thereof;  
FIG. 24 is a left side view thereof;  
FIG. 25 is a top view thereof;  
FIG. 26 is a bottom view thereof;  
FIG. 27 is a top left isometric view of the fourth toy dinosaur of the toy dinosaur set, shown broken away for ease of illustration;  
FIG. 28 is a bottom right rear isometric view thereof;  
FIG. 29 is a front view thereof;  
FIG. 30 is a rear view thereof;  
FIG. 31 is a right side view thereof;  
FIG. 32 is a left side view thereof;  
FIG. 33 is a top view thereof; and,  
FIG. 34 is a bottom view thereof.

**1 Claim, 18 Drawing Sheets**

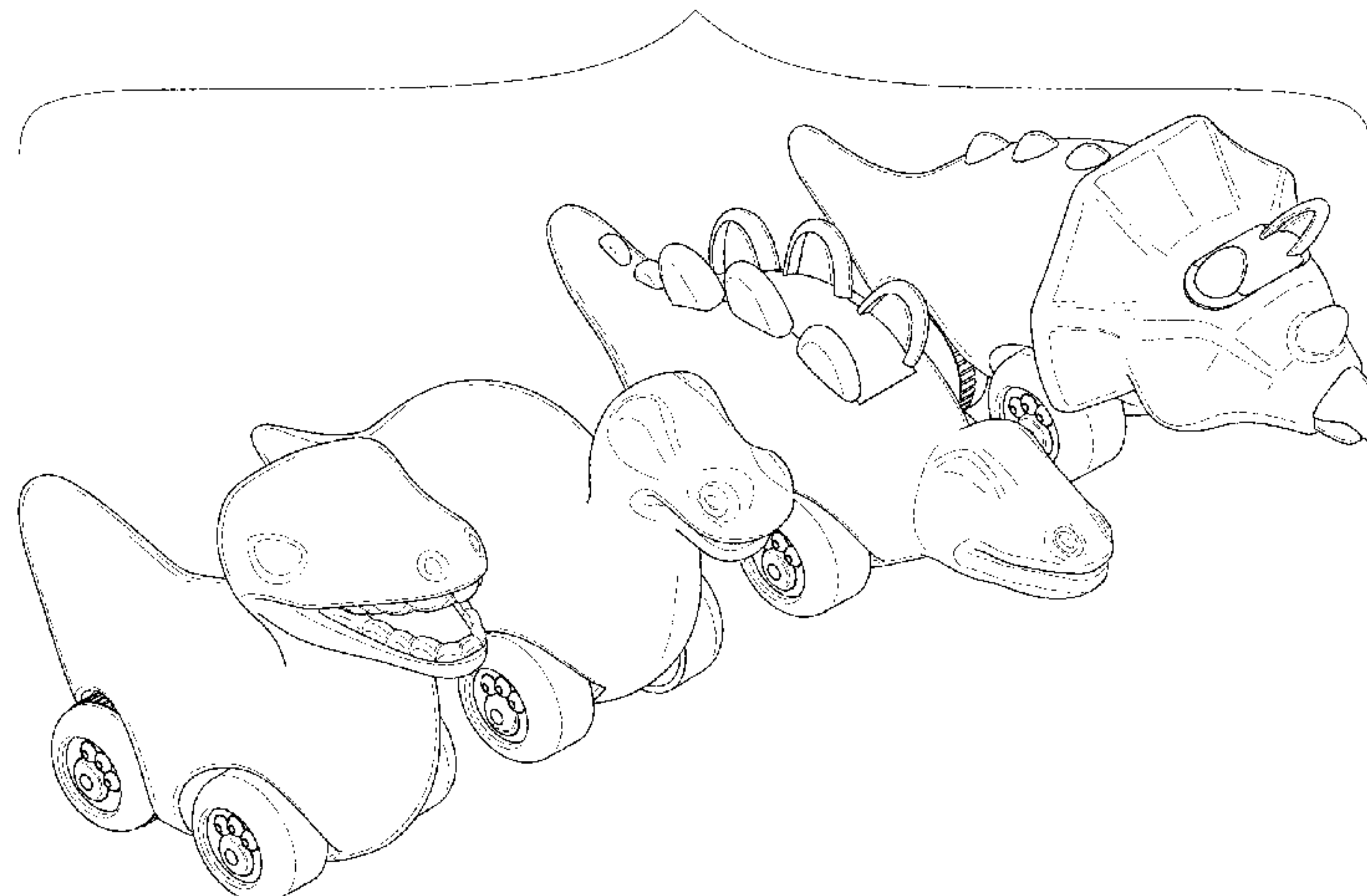

(58) **Field of Classification Search**

CPC ... A63H 3/00; A63H 3/02; A63H 3/04; A63H  
3/16; A63H 3/20; A63H 33/00; A63H  
7/00; A63H 11/00

See application file for complete search history.

(56) **References Cited**

U.S. PATENT DOCUMENTS

D316,733	S	*	5/1991	Volpe	.....	D21/615
D317,188	S	*	5/1991	Volpe	.....	D21/615
D374,044	S	*	9/1996	Doi	.....	D21/592
D387,100	S	*	12/1997	Nielsen	.....	D21/615
D387,101	S	*	12/1997	Nielsen	.....	D21/615
D388,476	S	*	12/1997	Nielsen	.....	D21/615
D388,478	S	*	12/1997	Nielsen	.....	D21/615
D394,693	S	*	5/1998	Koutsouflakis	.....	D21/615
D402,705	S	*	12/1998	Jenkins	.....	D21/615
D519,578	S	*	4/2006	Carruth	.....	D21/592
D609,285	S	*	2/2010	Wilson	.....	D21/615
D636,033	S	*	4/2011	Oestreicher	.....	D21/615
D747,777	S	*	1/2016	Greenly	.....	D21/578
D762,271	S	*	7/2016	Chow	.....	D21/578

\* cited by examiner

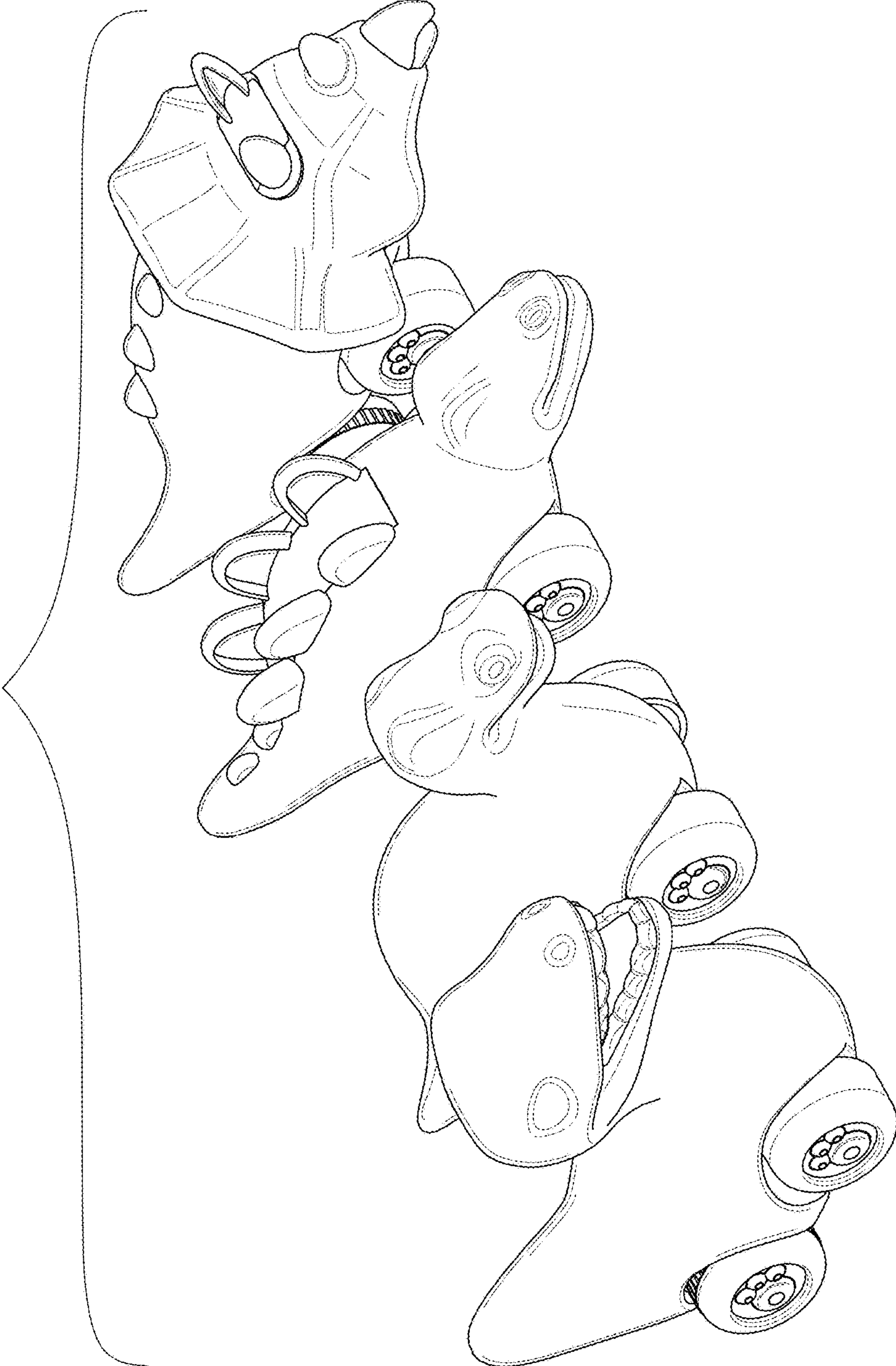

FIG. 1



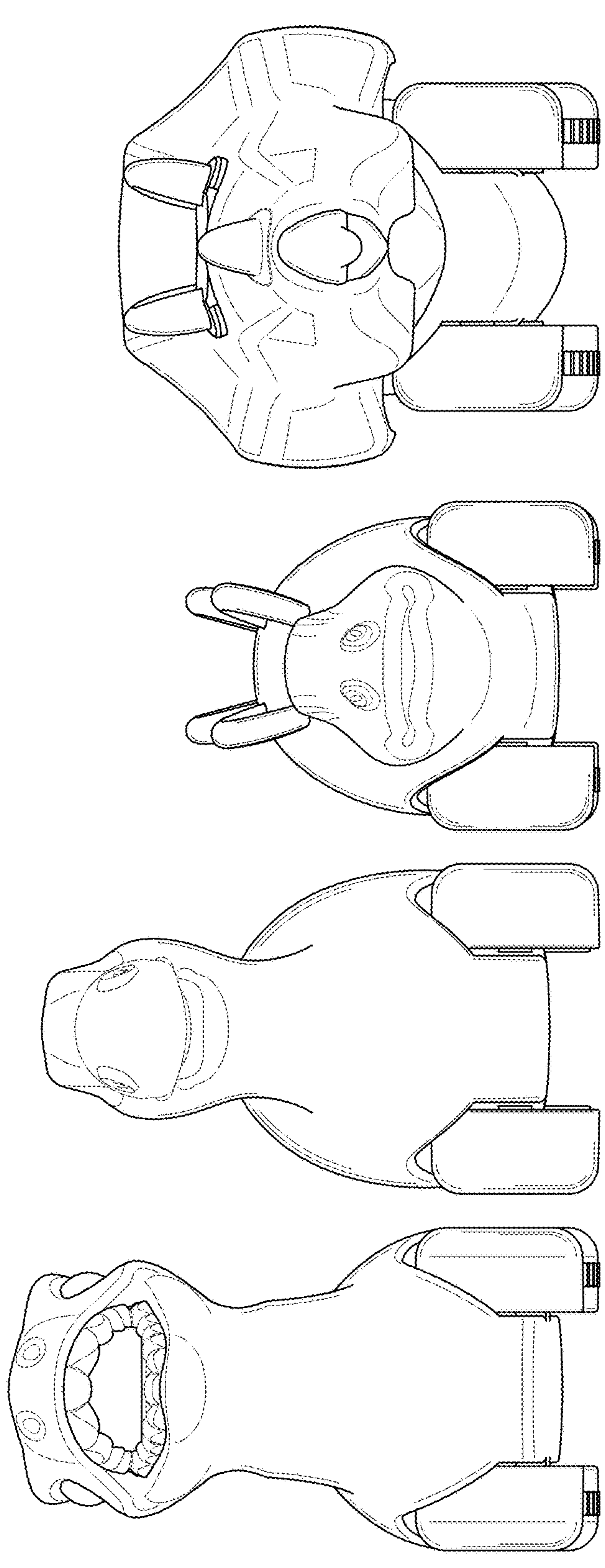

FIG. 2

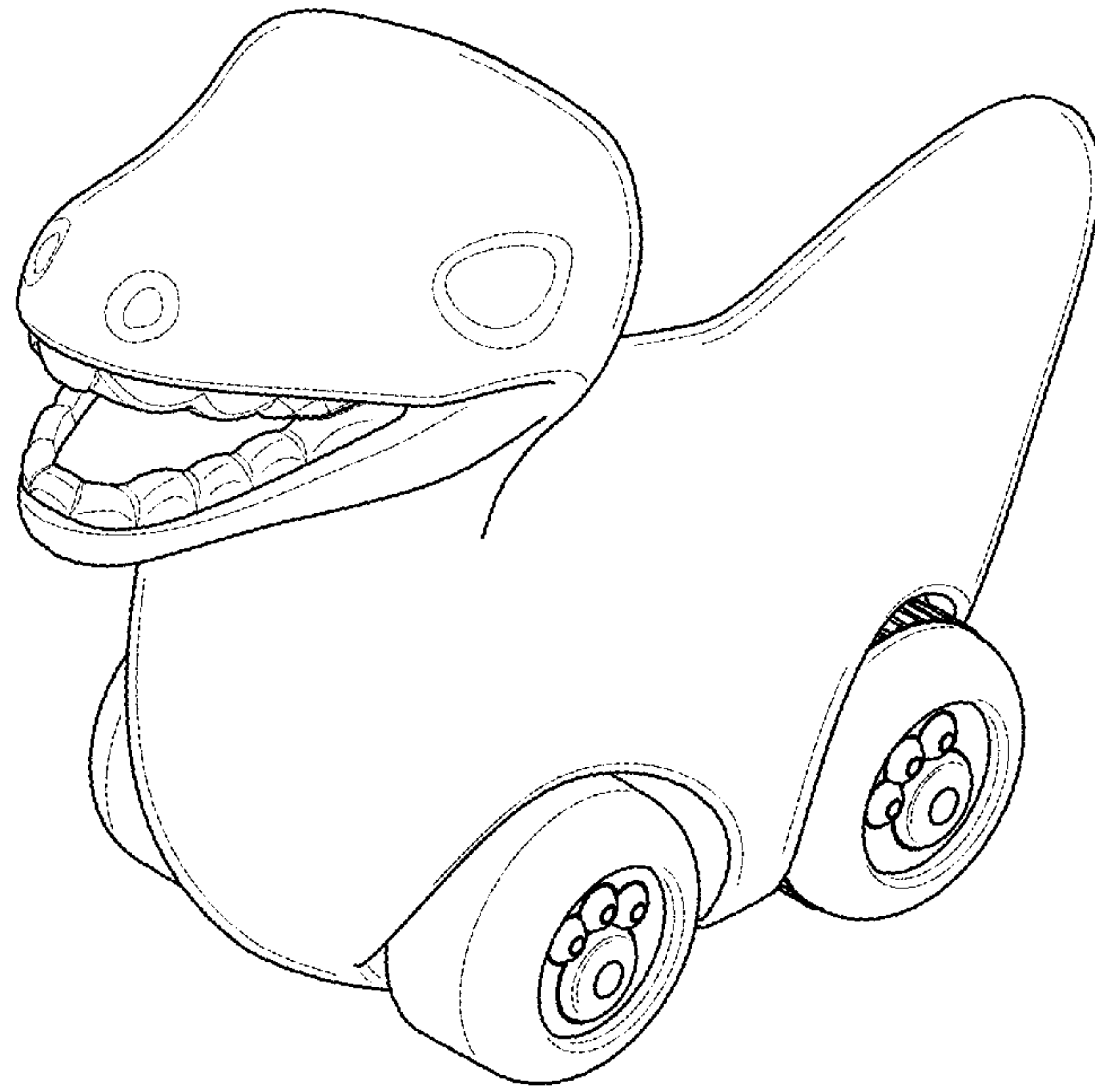

FIG. 3

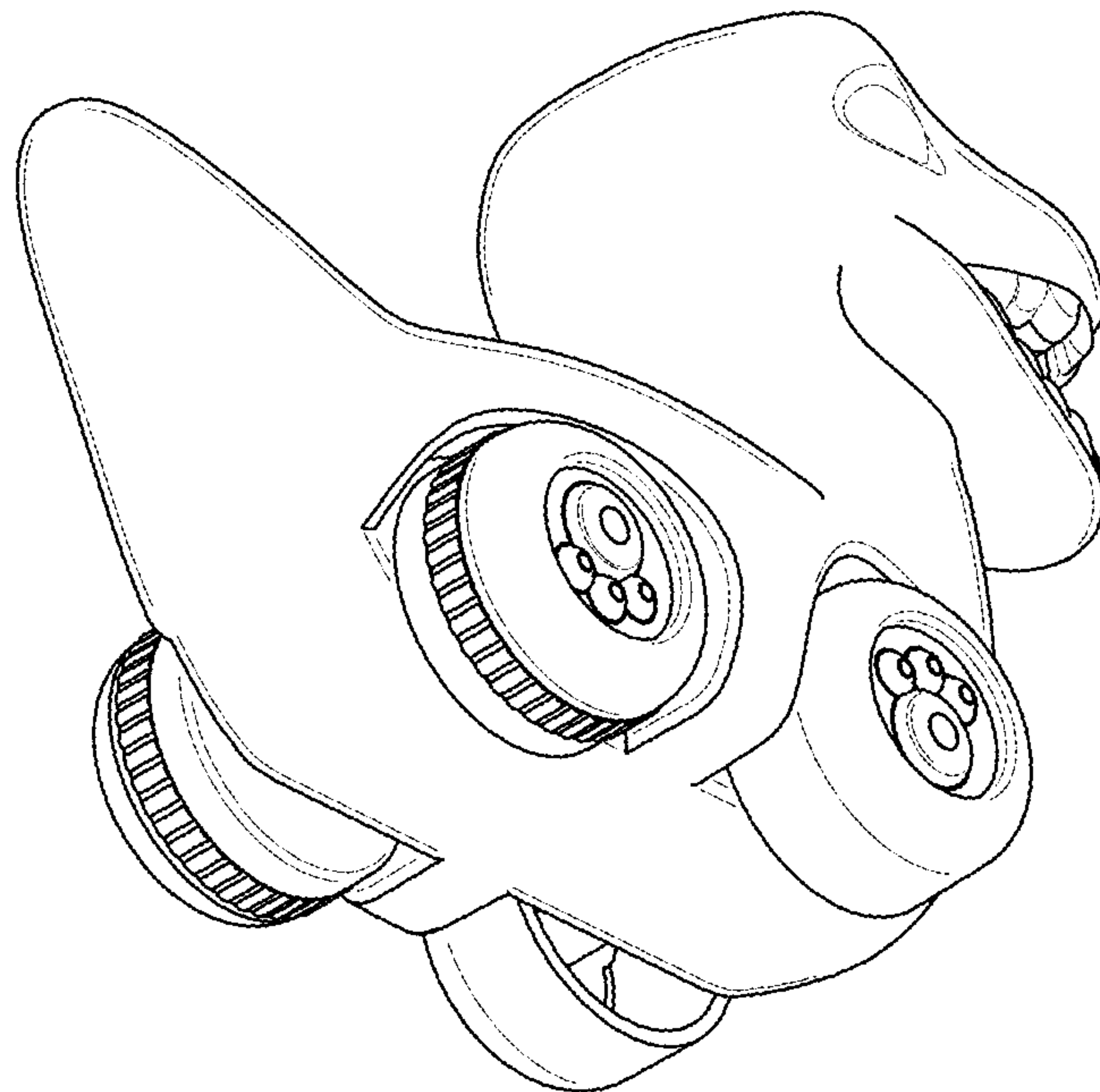

FIG. 4

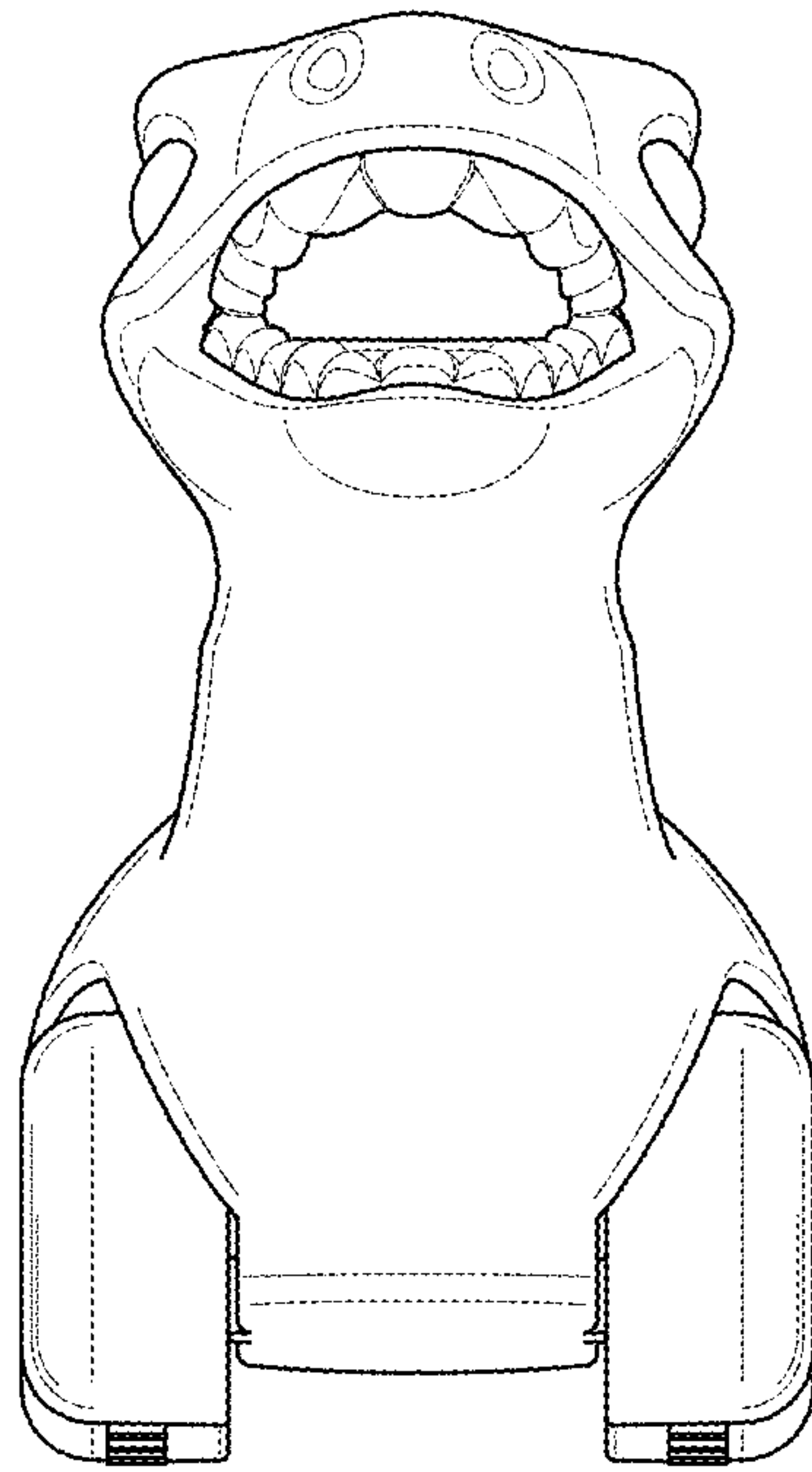

FIG. 5

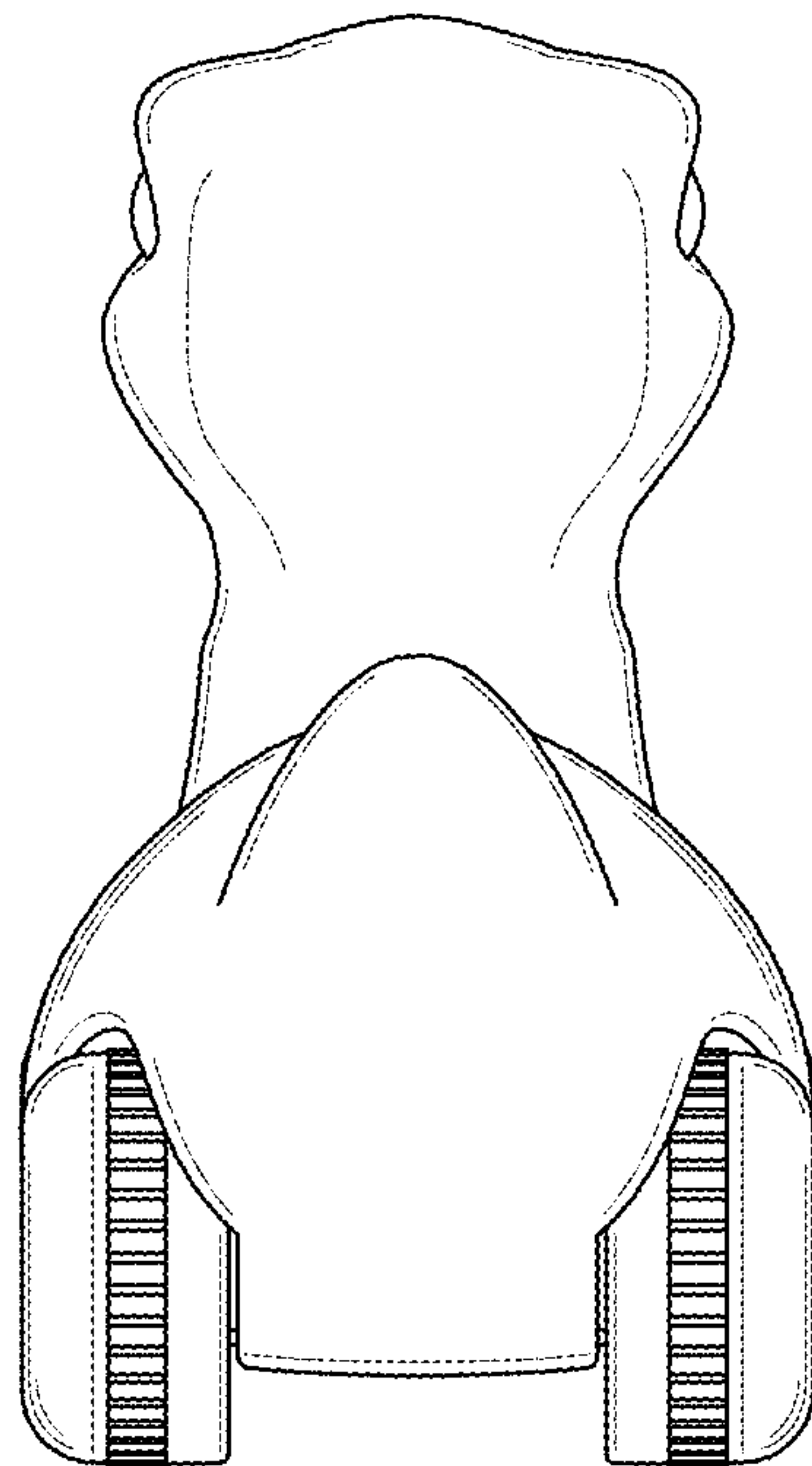

FIG. 6

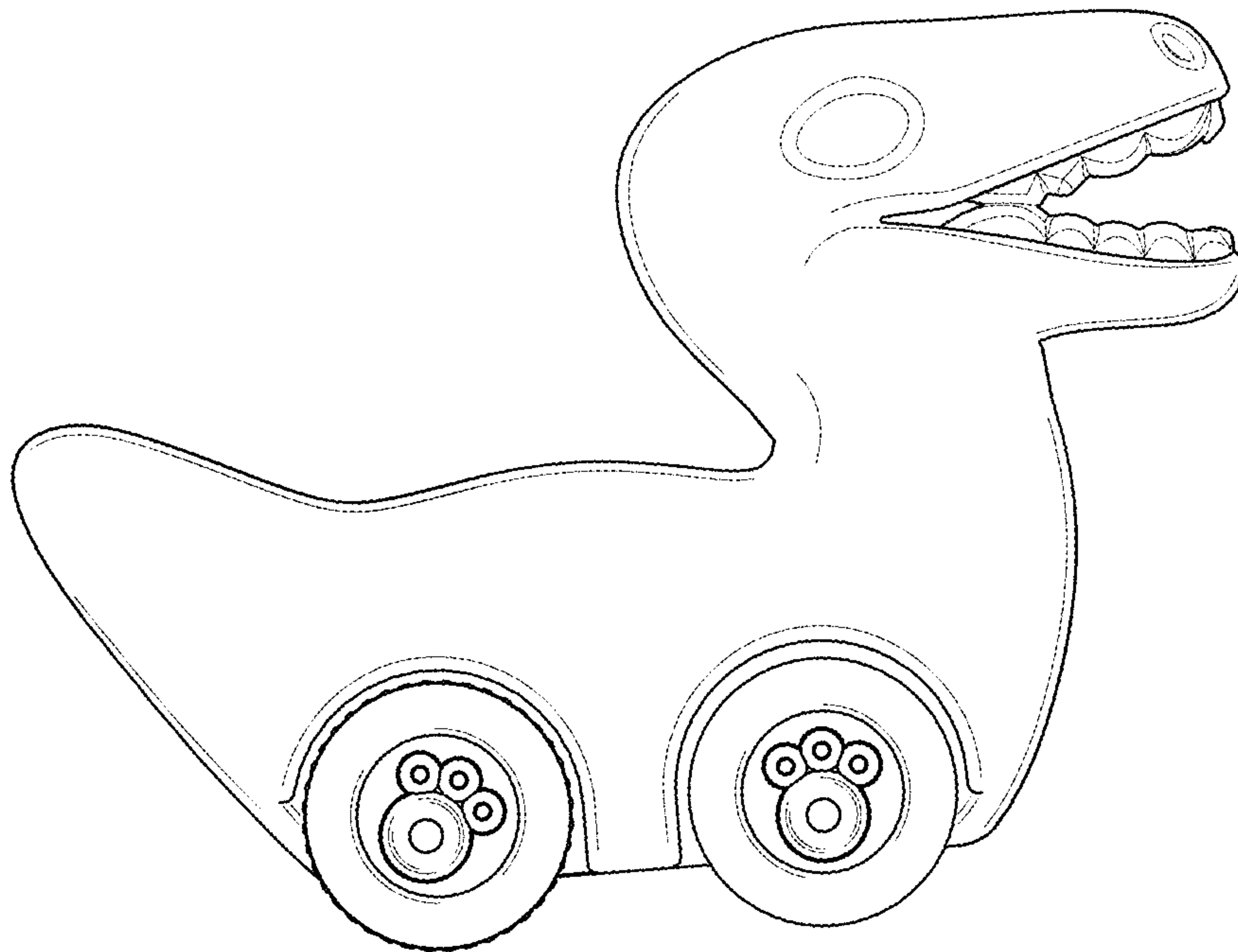

FIG. 7

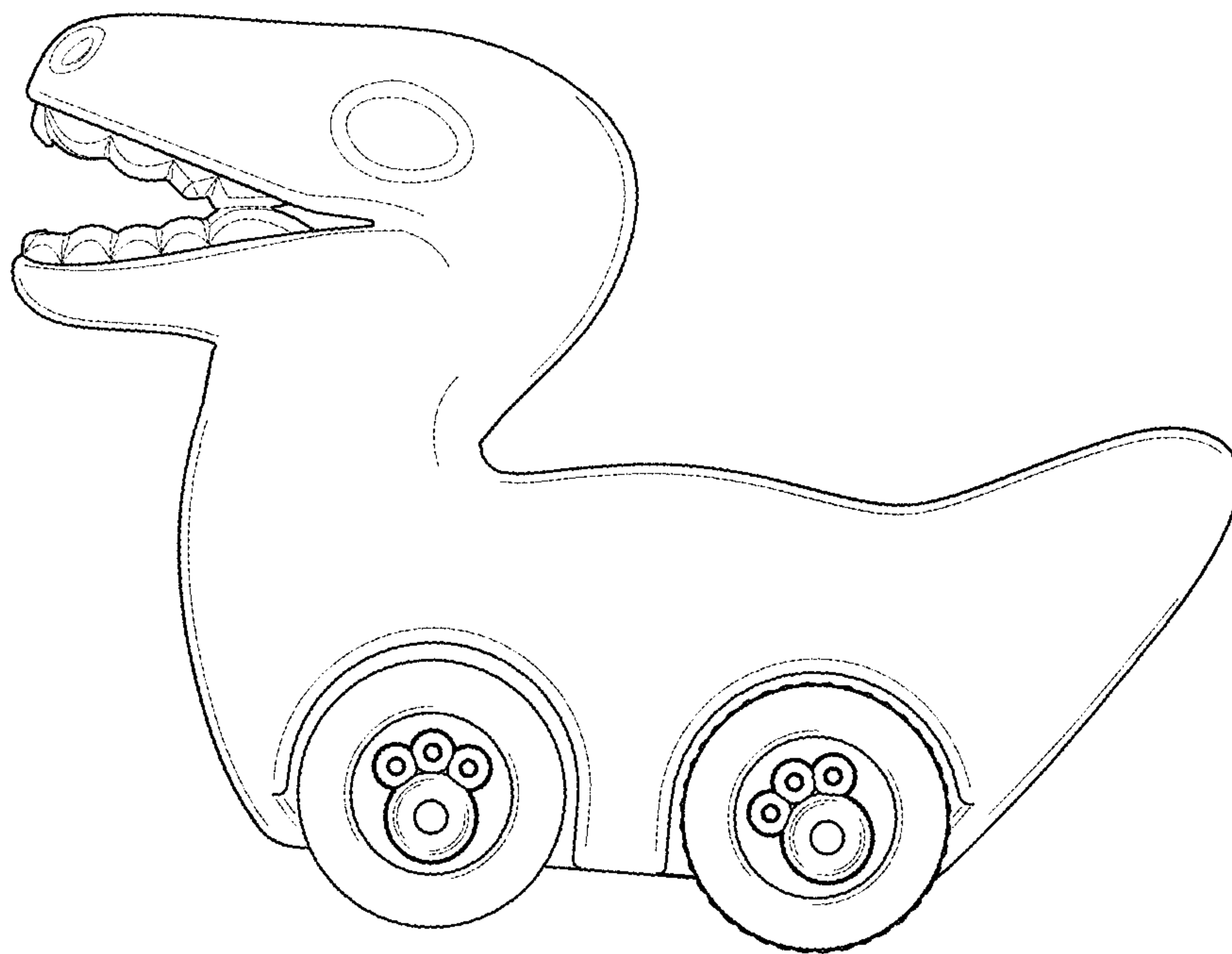

FIG. 8

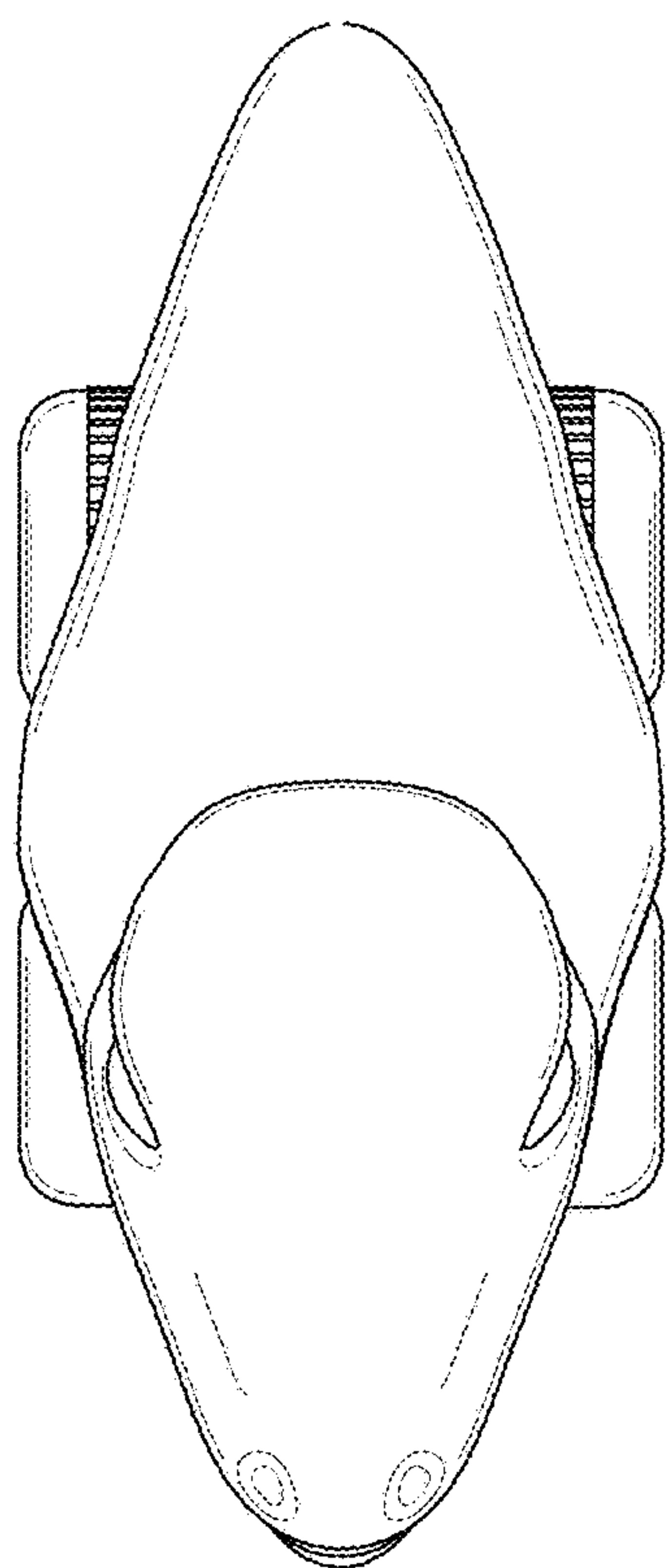

FIG. 9

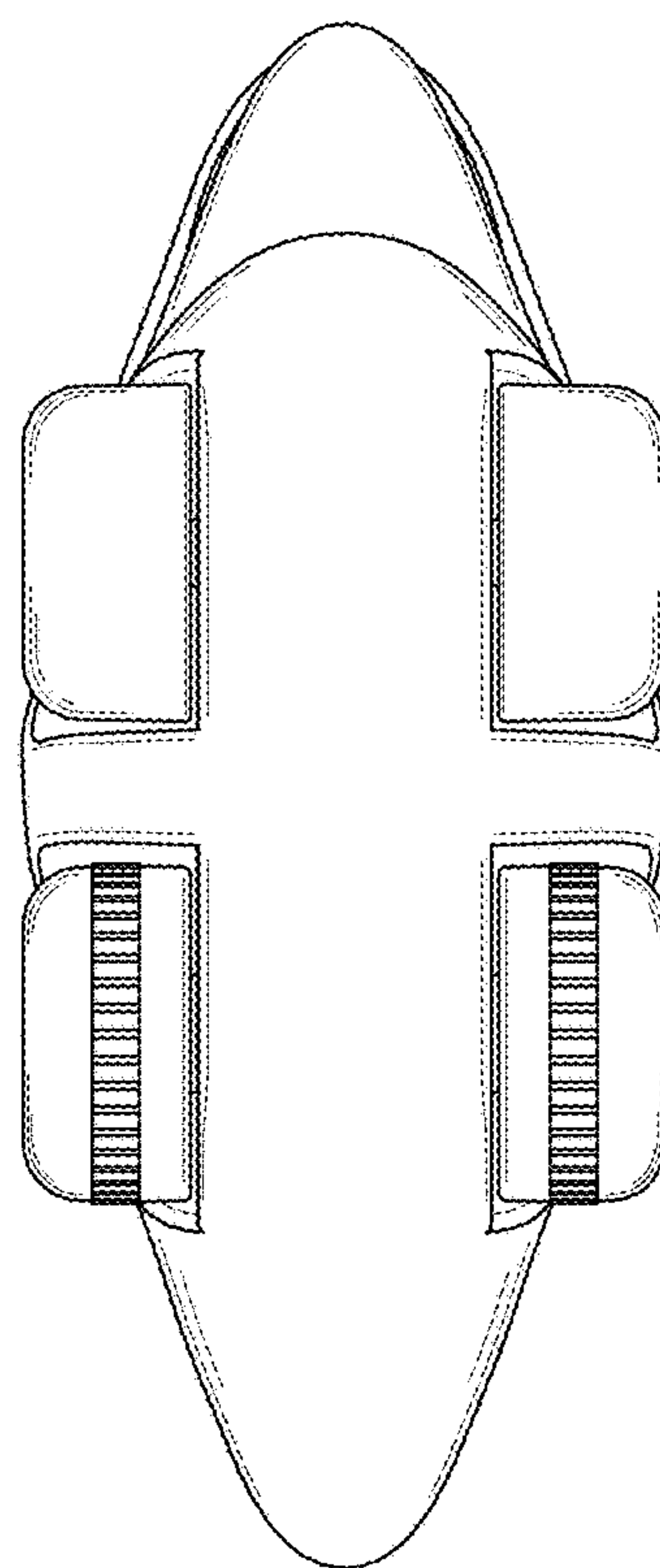

FIG. 10



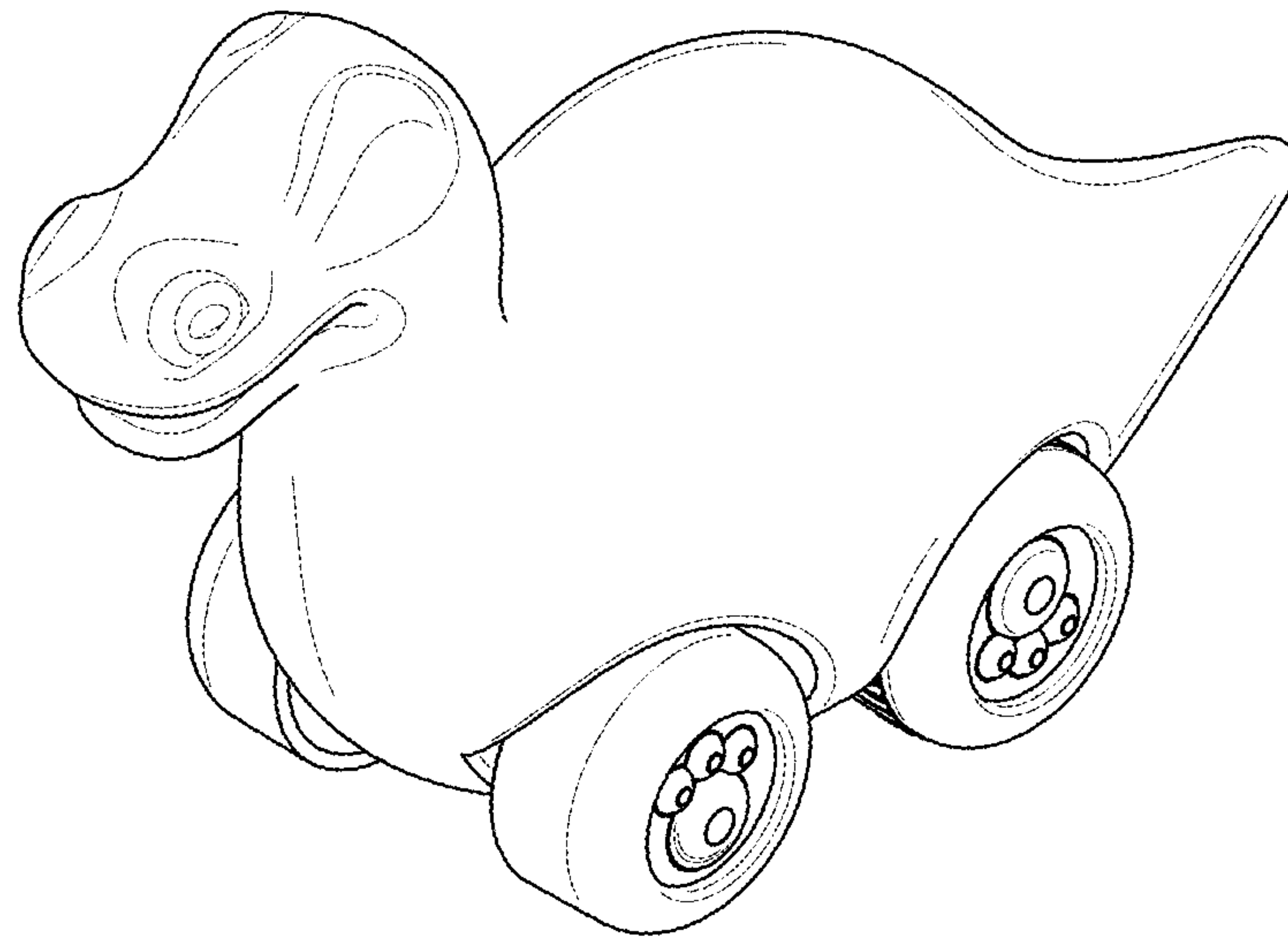

FIG. 11

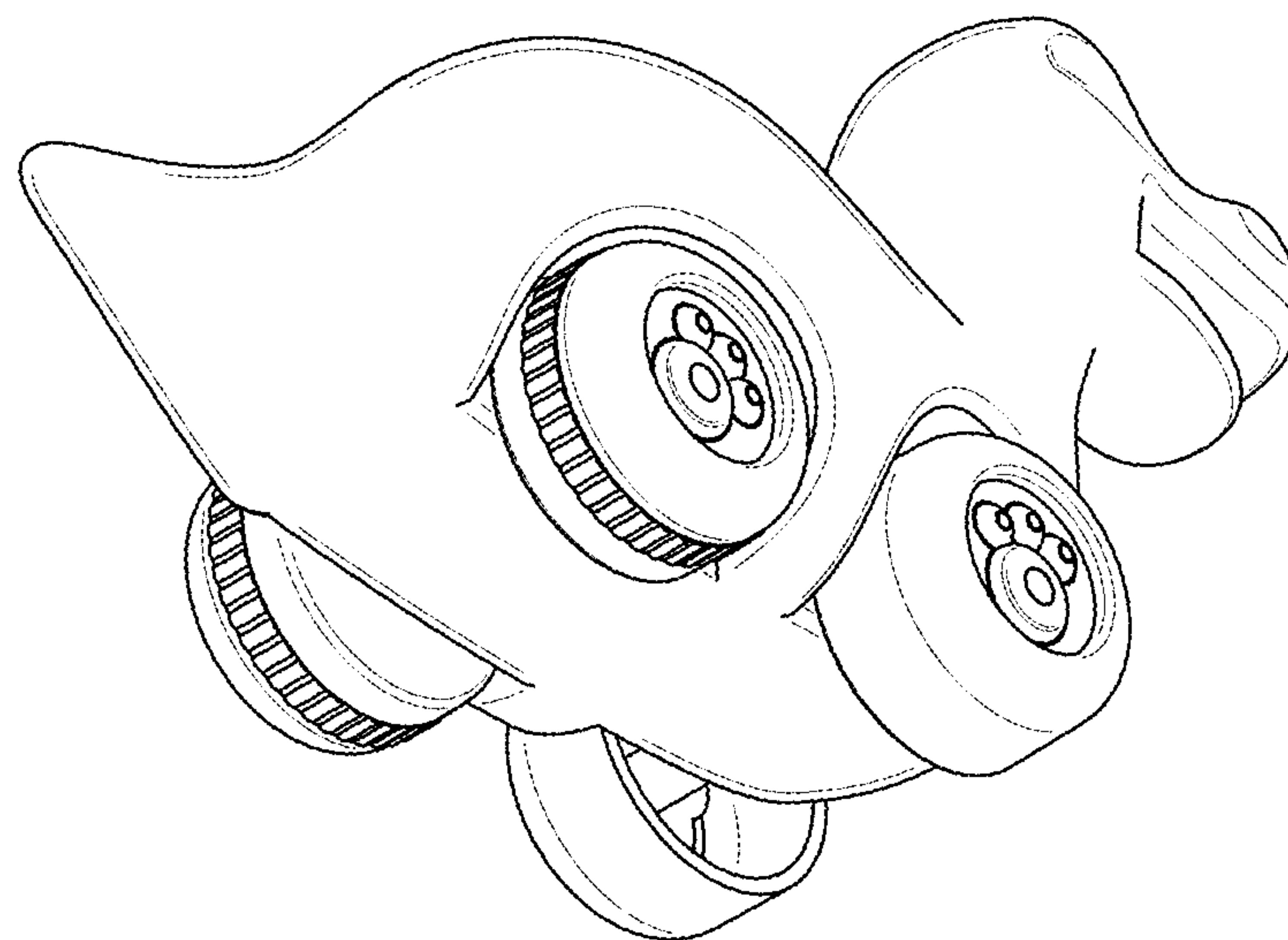

FIG. 12

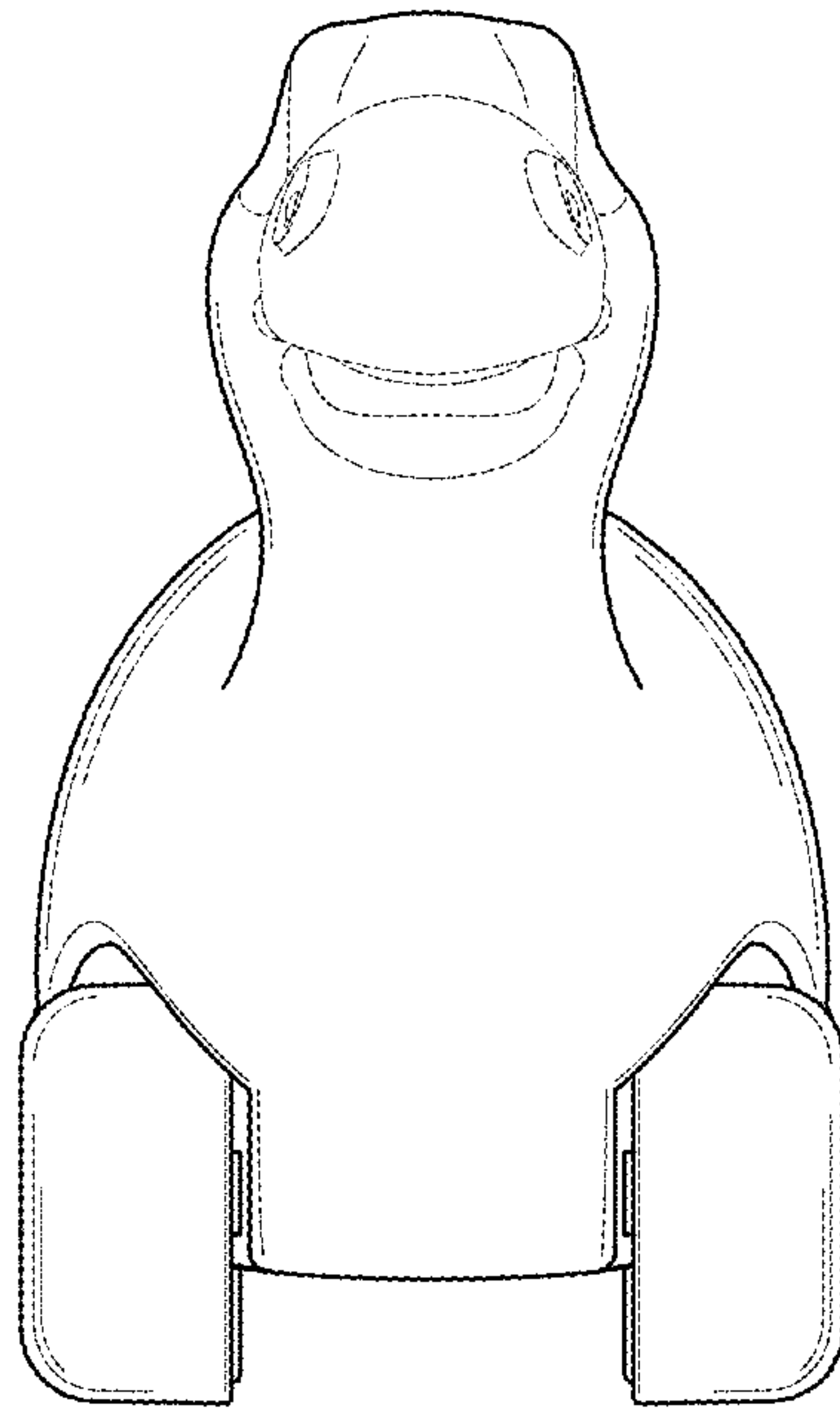

FIG. 13

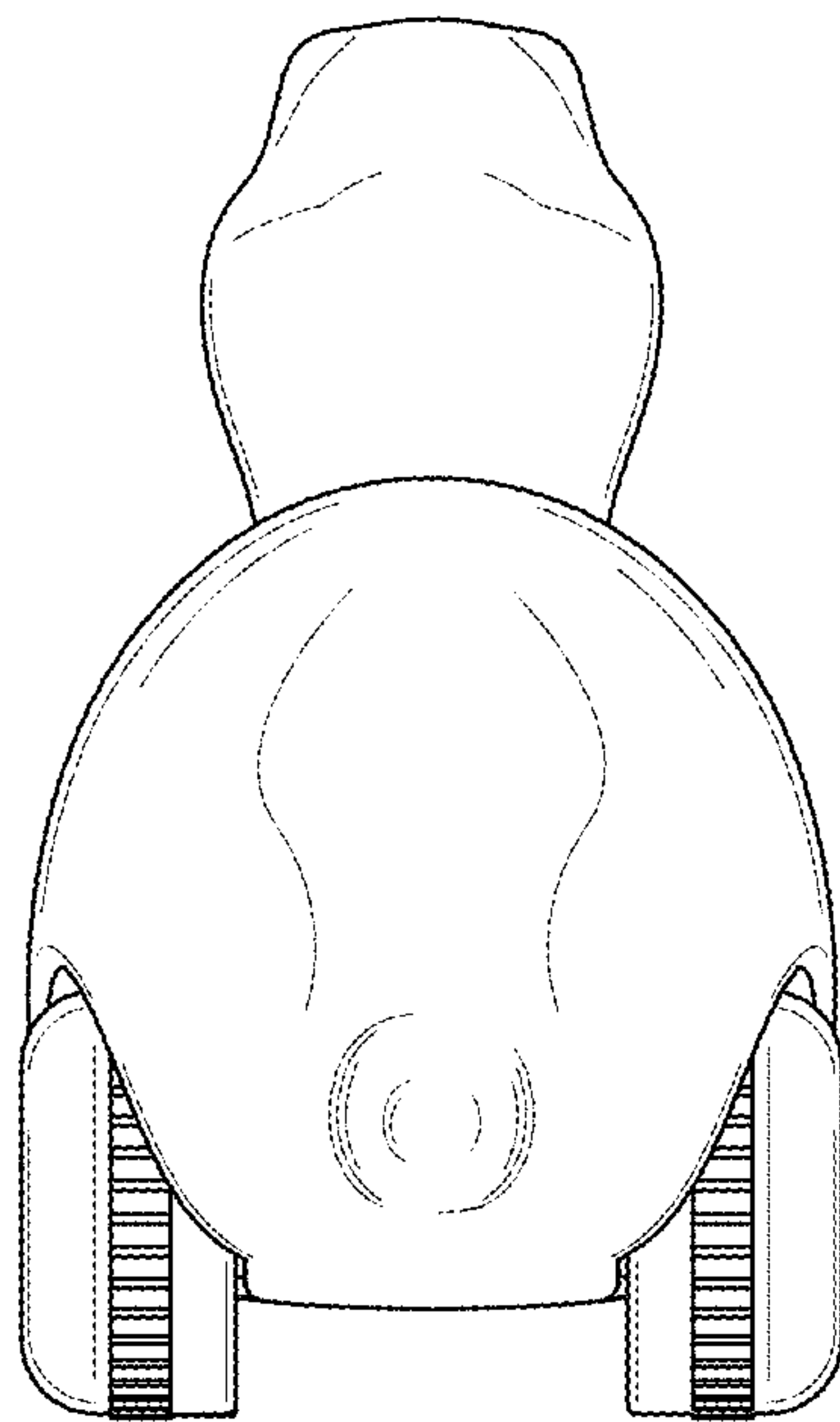

FIG. 14

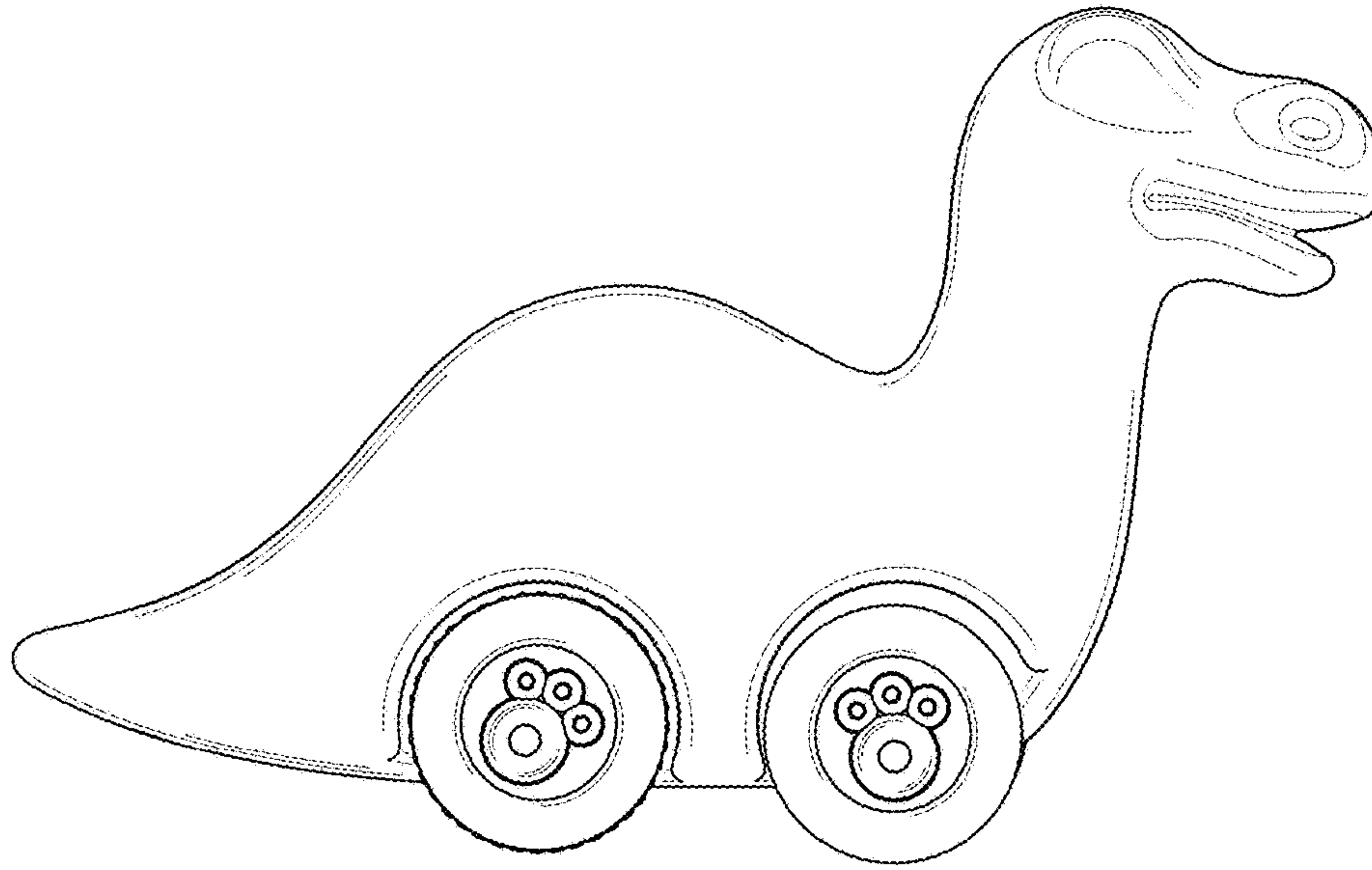

FIG. 15

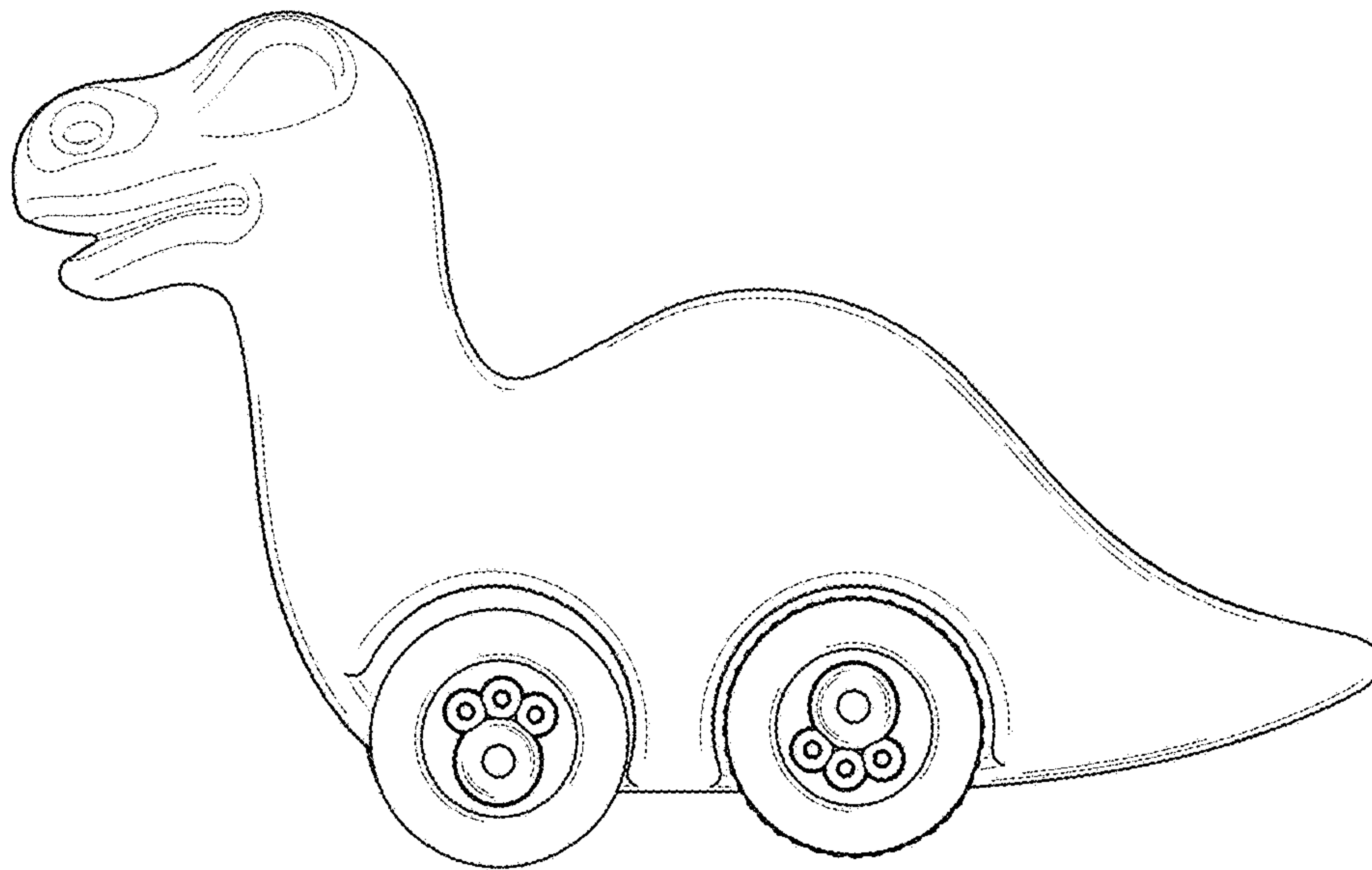

FIG. 16

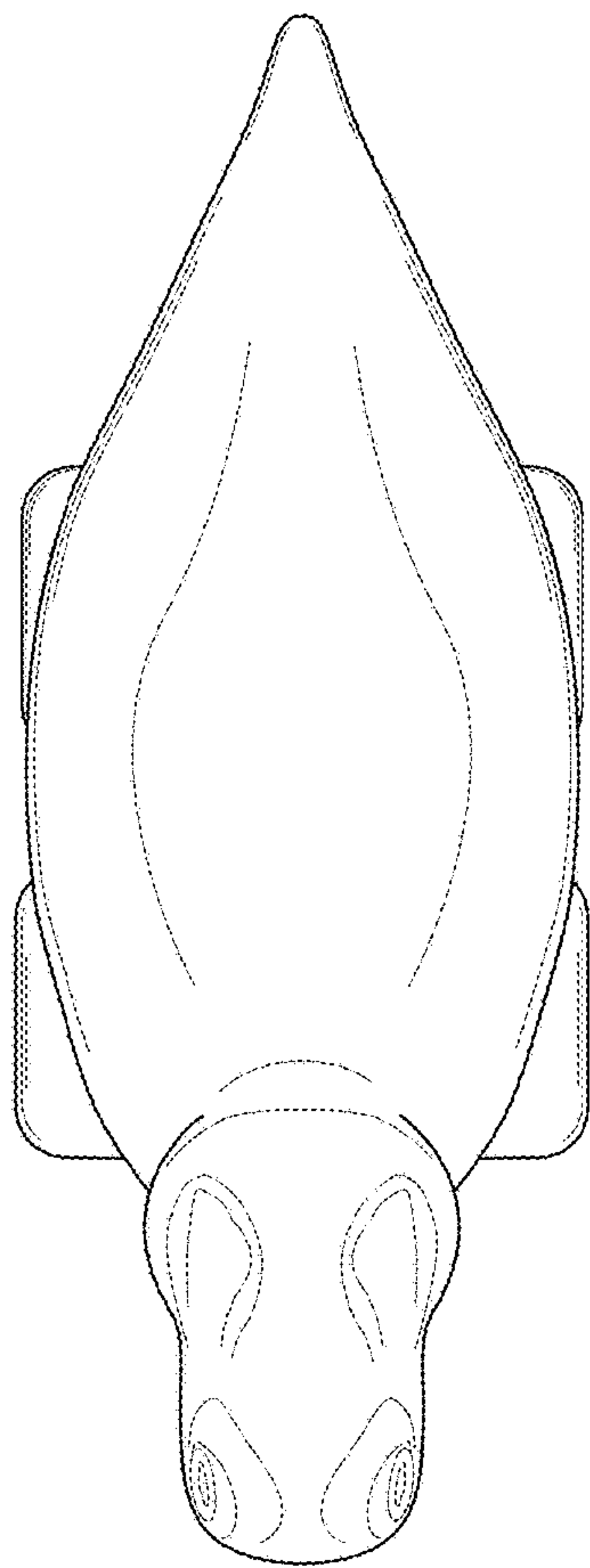

FIG. 17

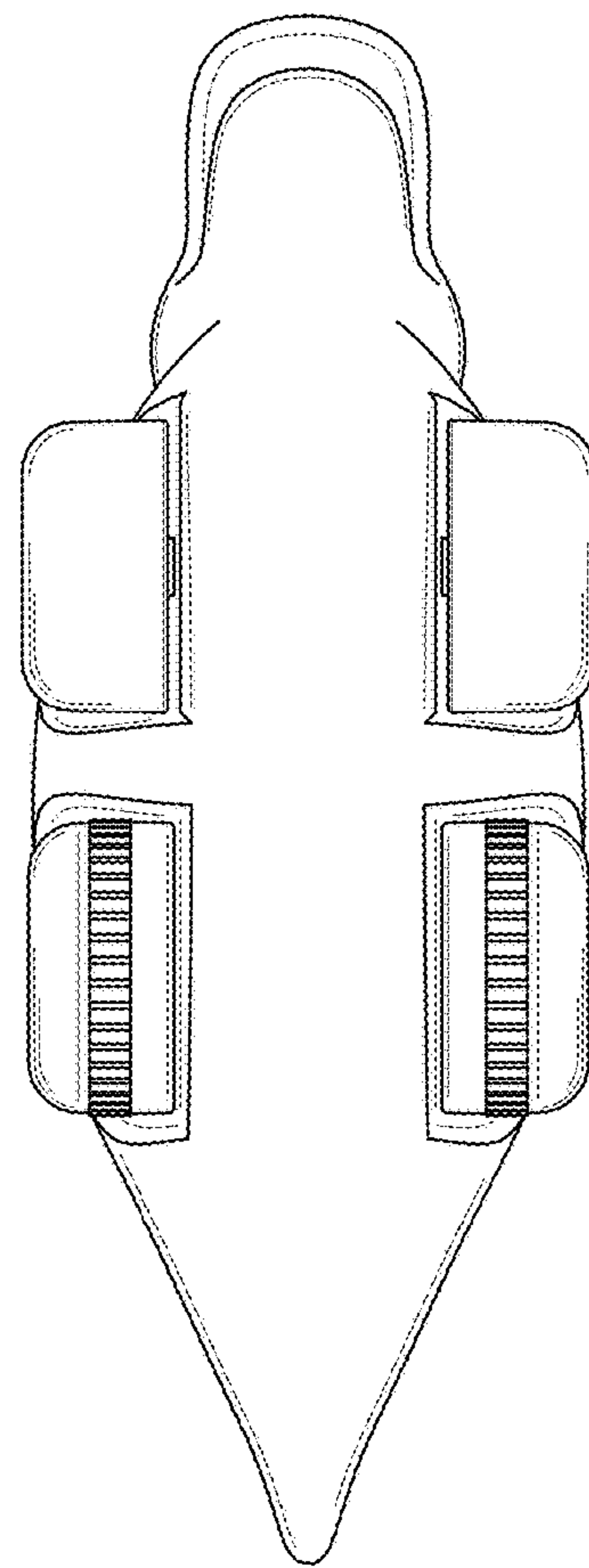

FIG. 18



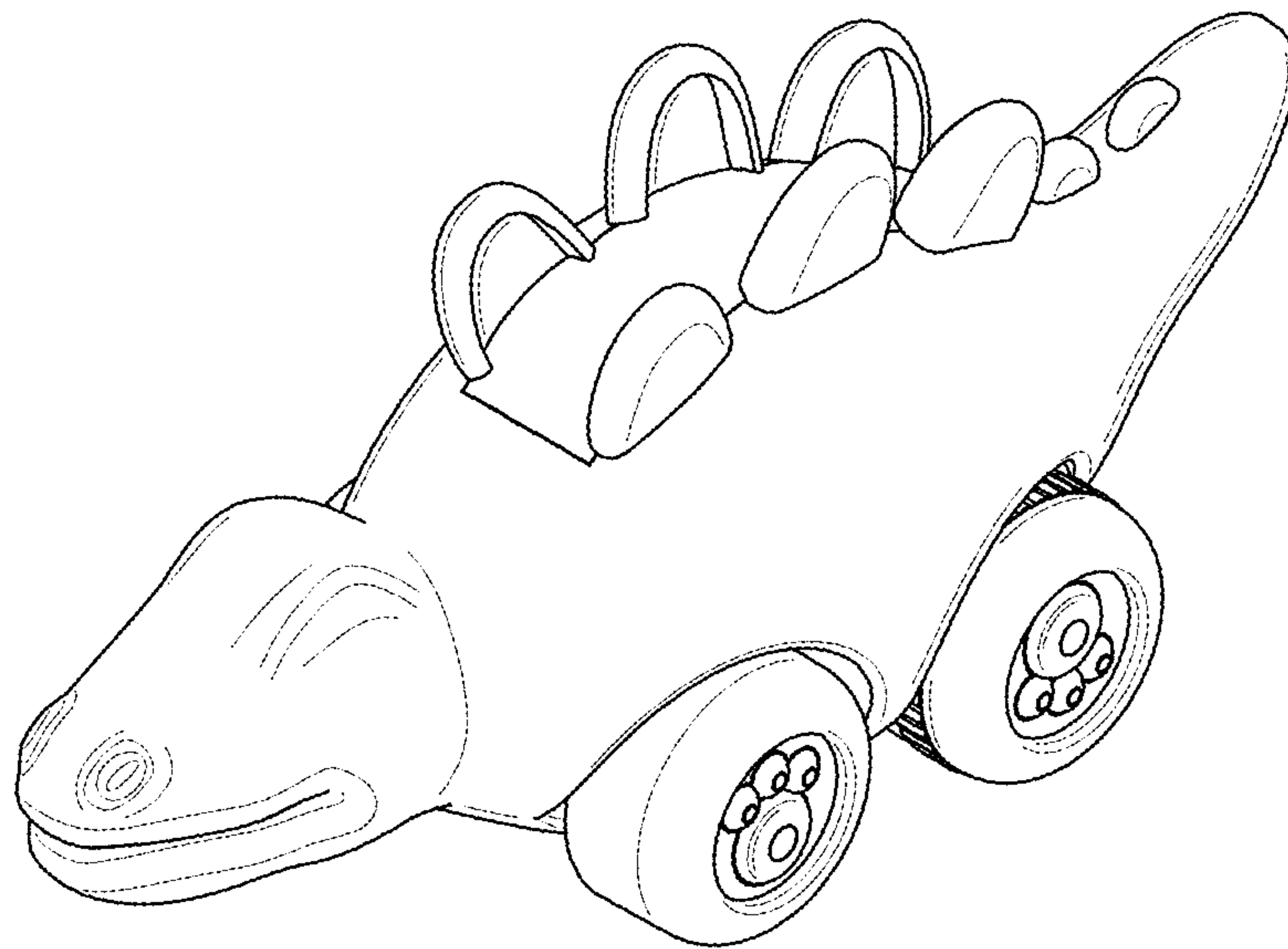

FIG. 19

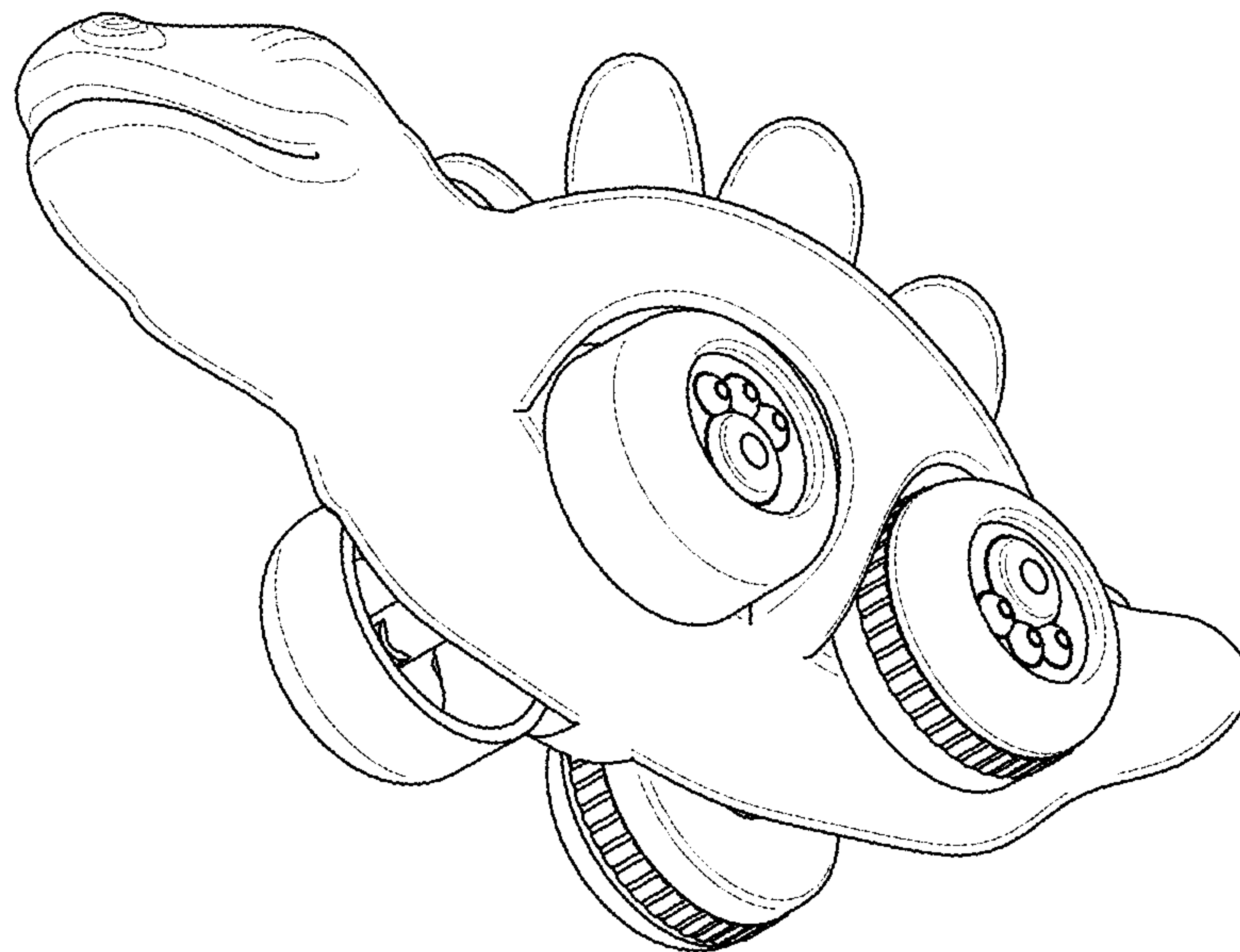

FIG. 20

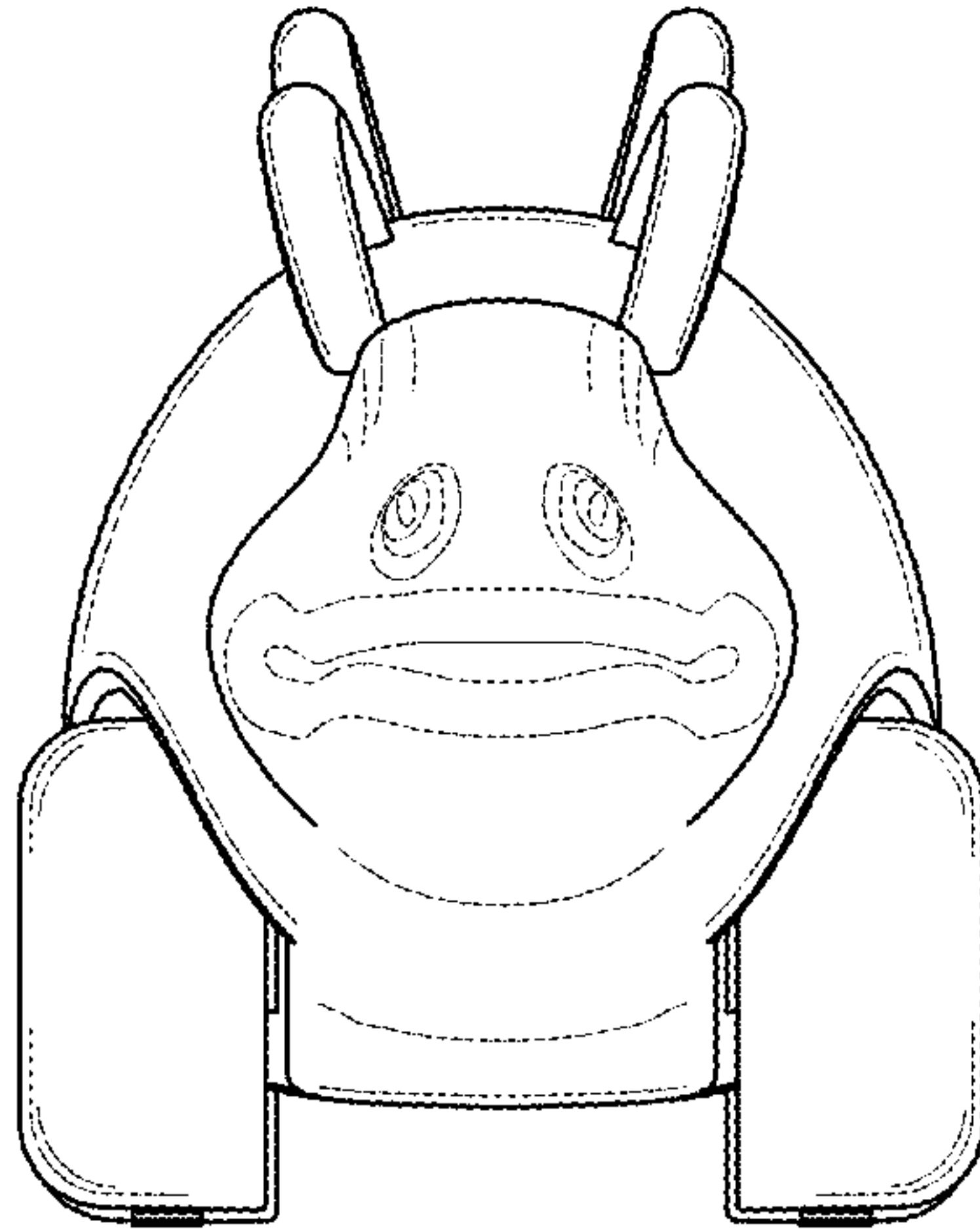

FIG. 21

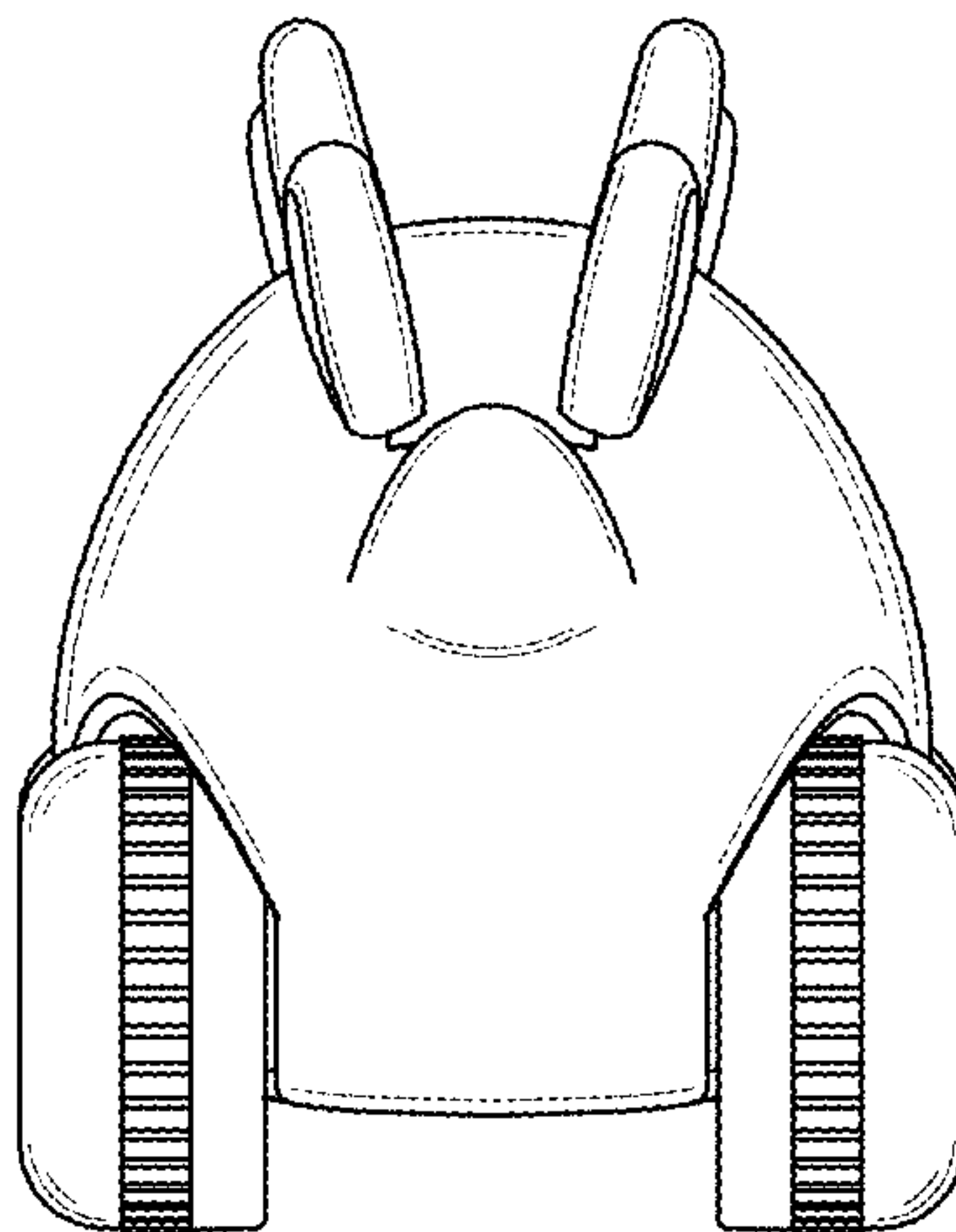

FIG. 22

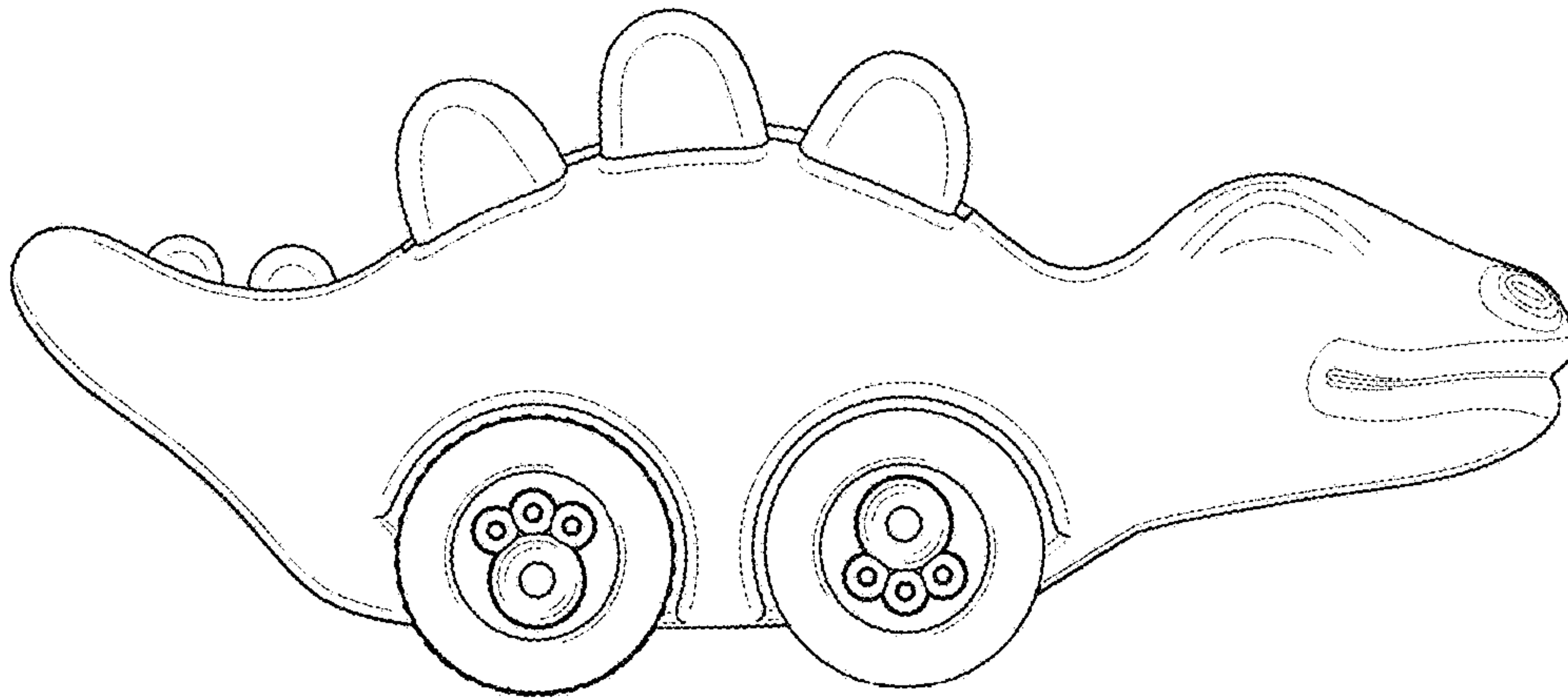

FIG. 23

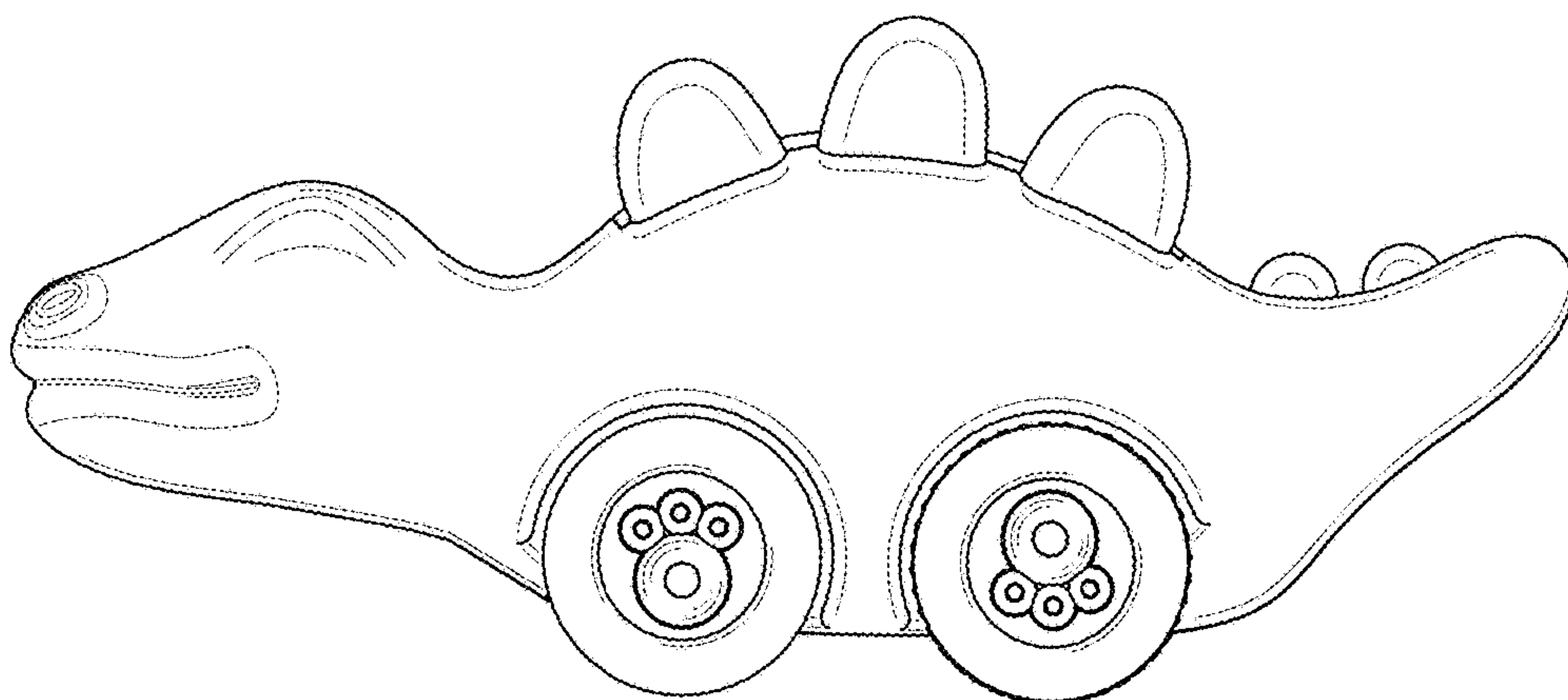

FIG. 24

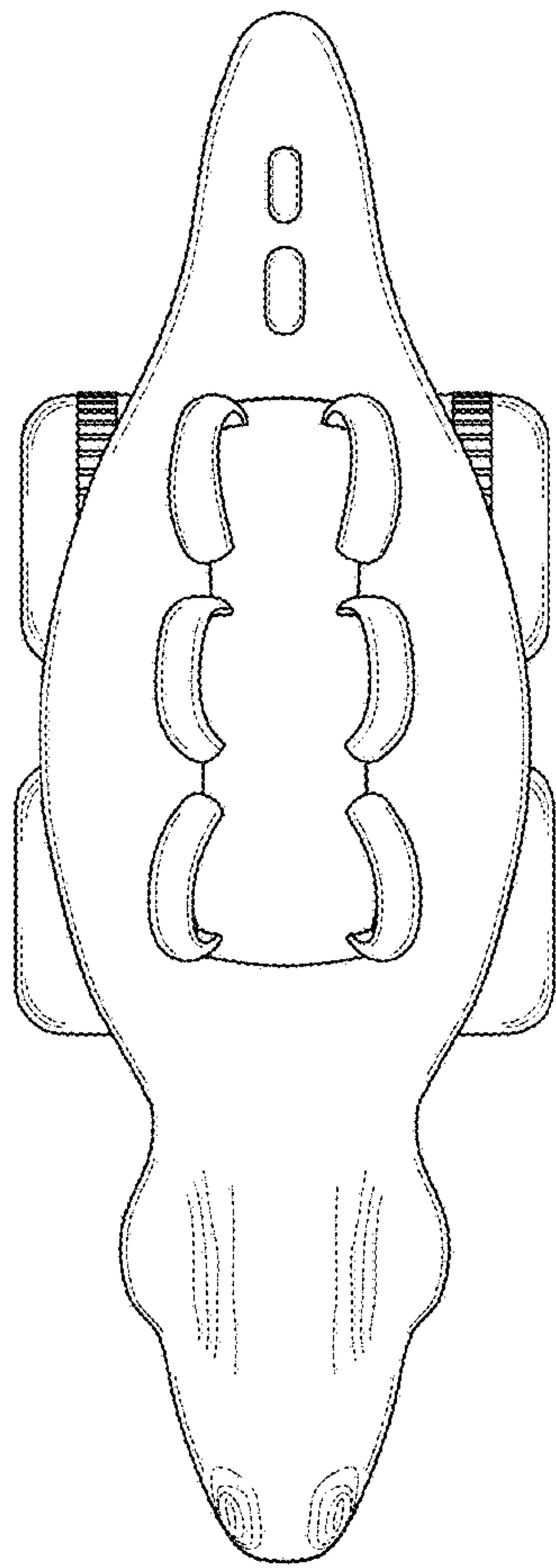

FIG. 25

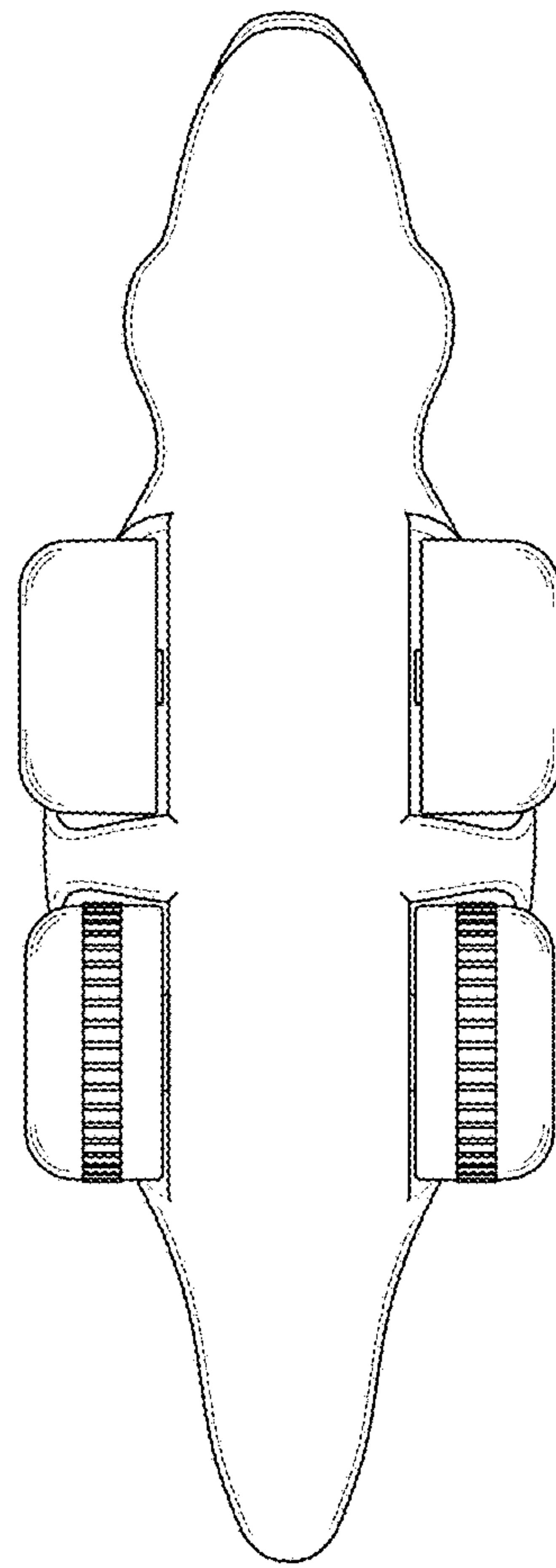

FIG. 26



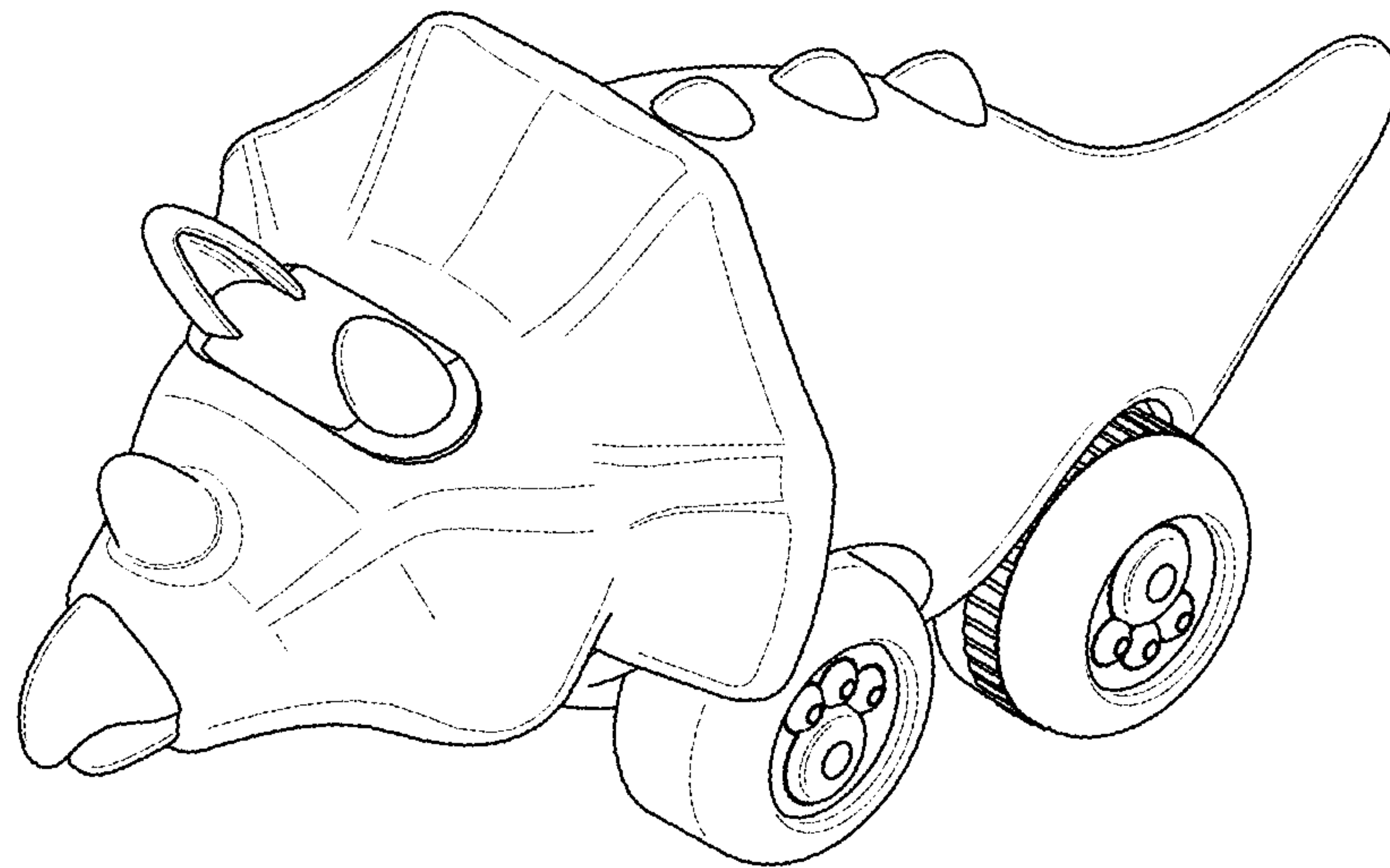

FIG. 27

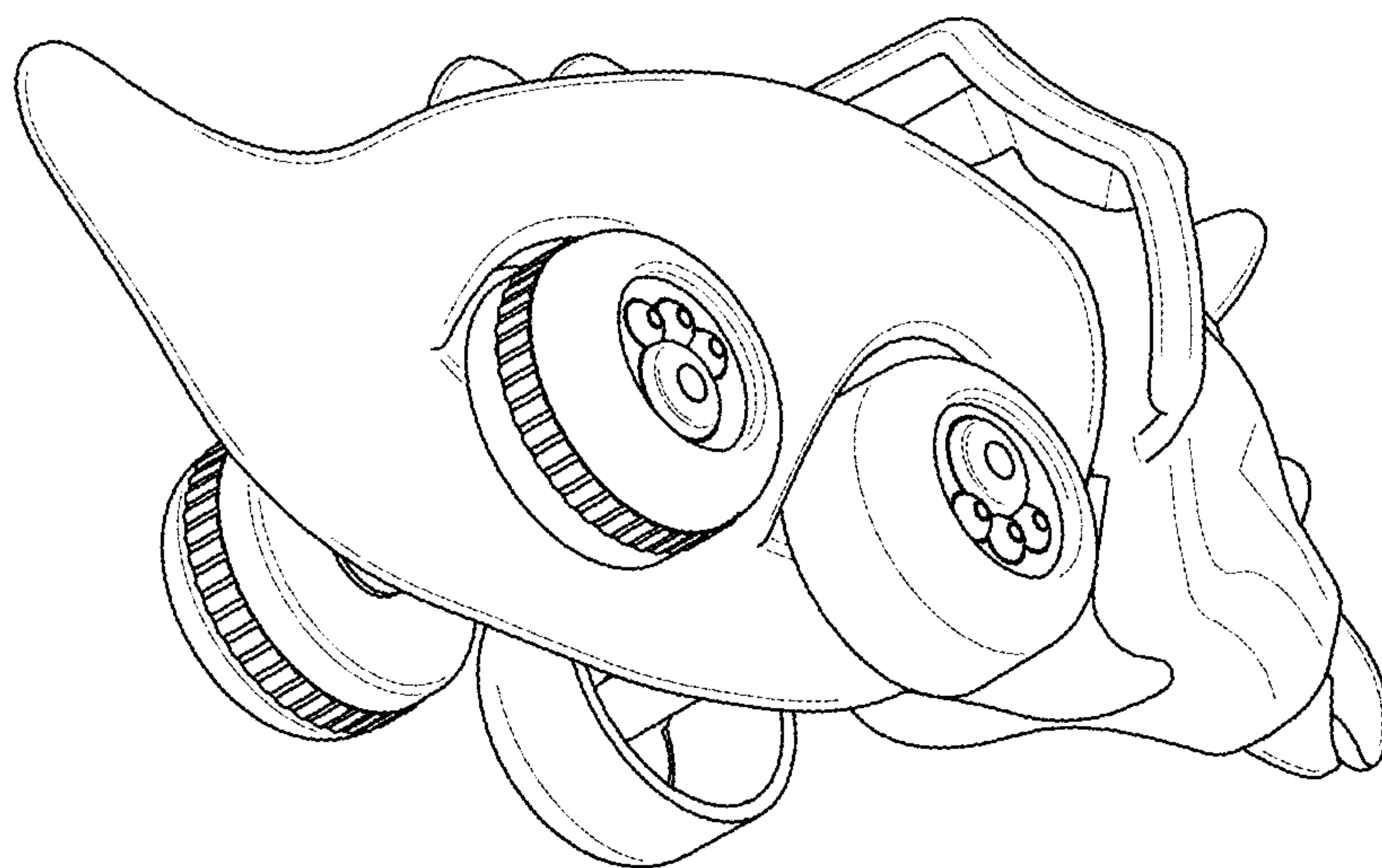

FIG. 28

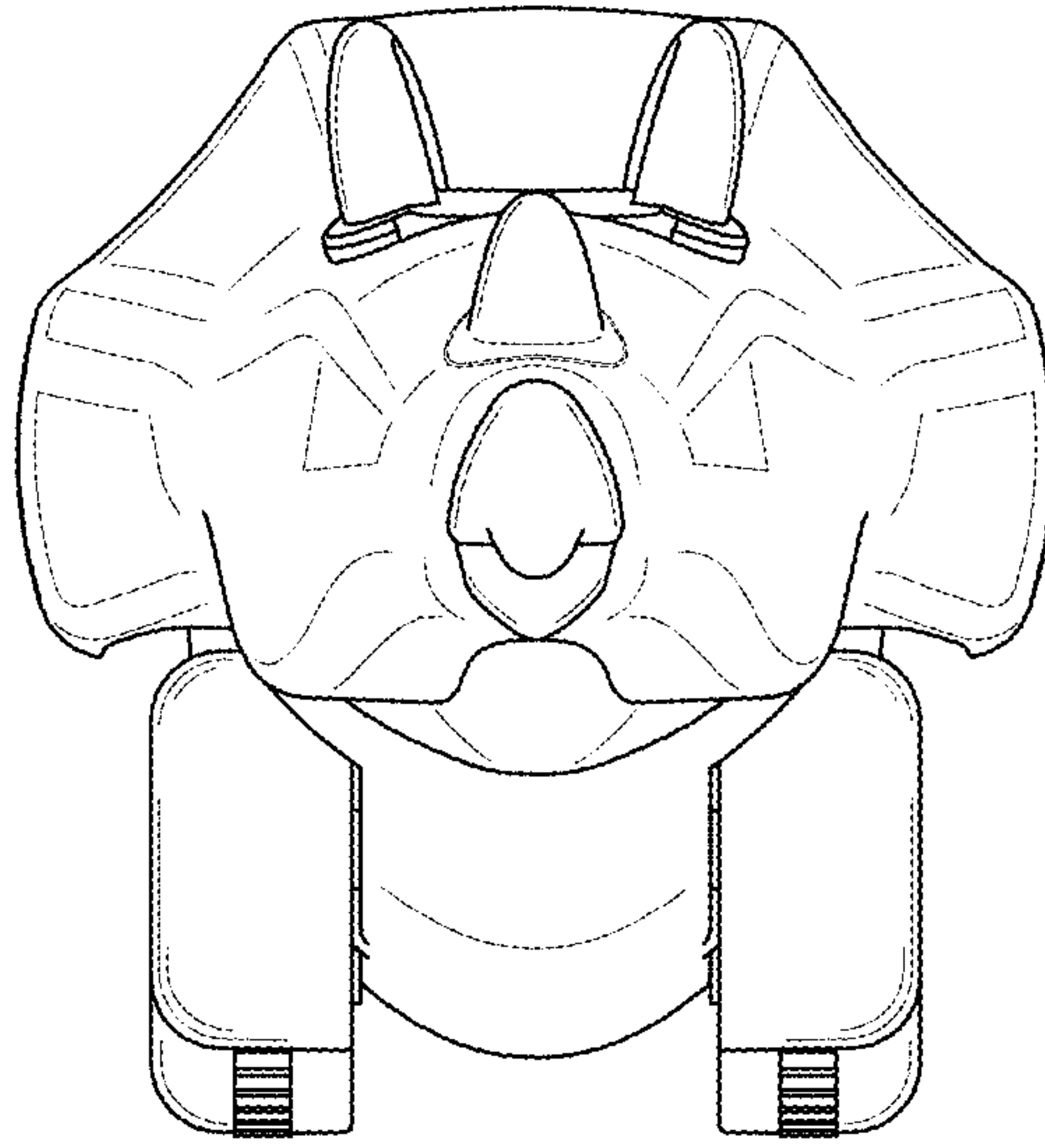

FIG. 29

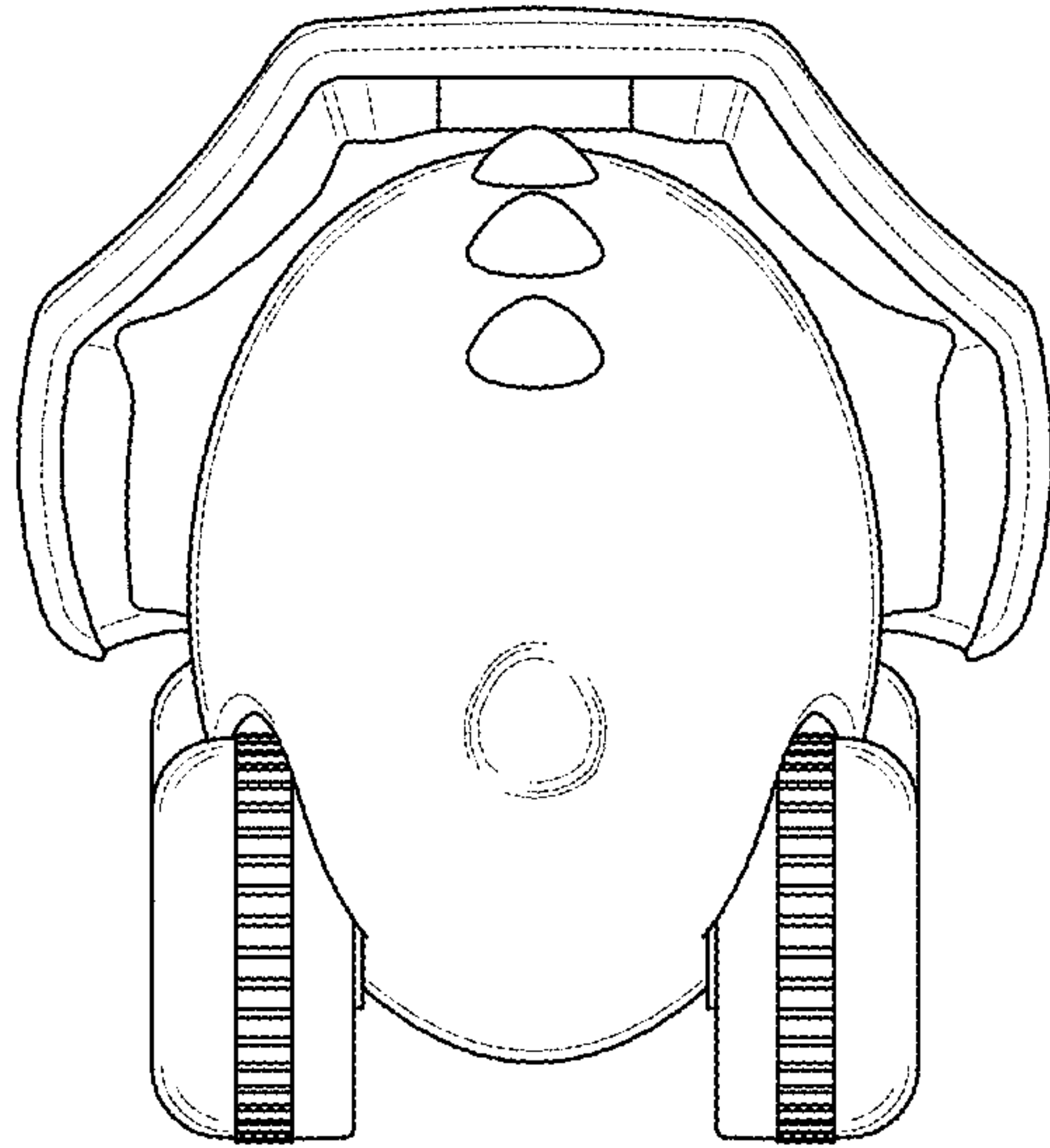

FIG. 30

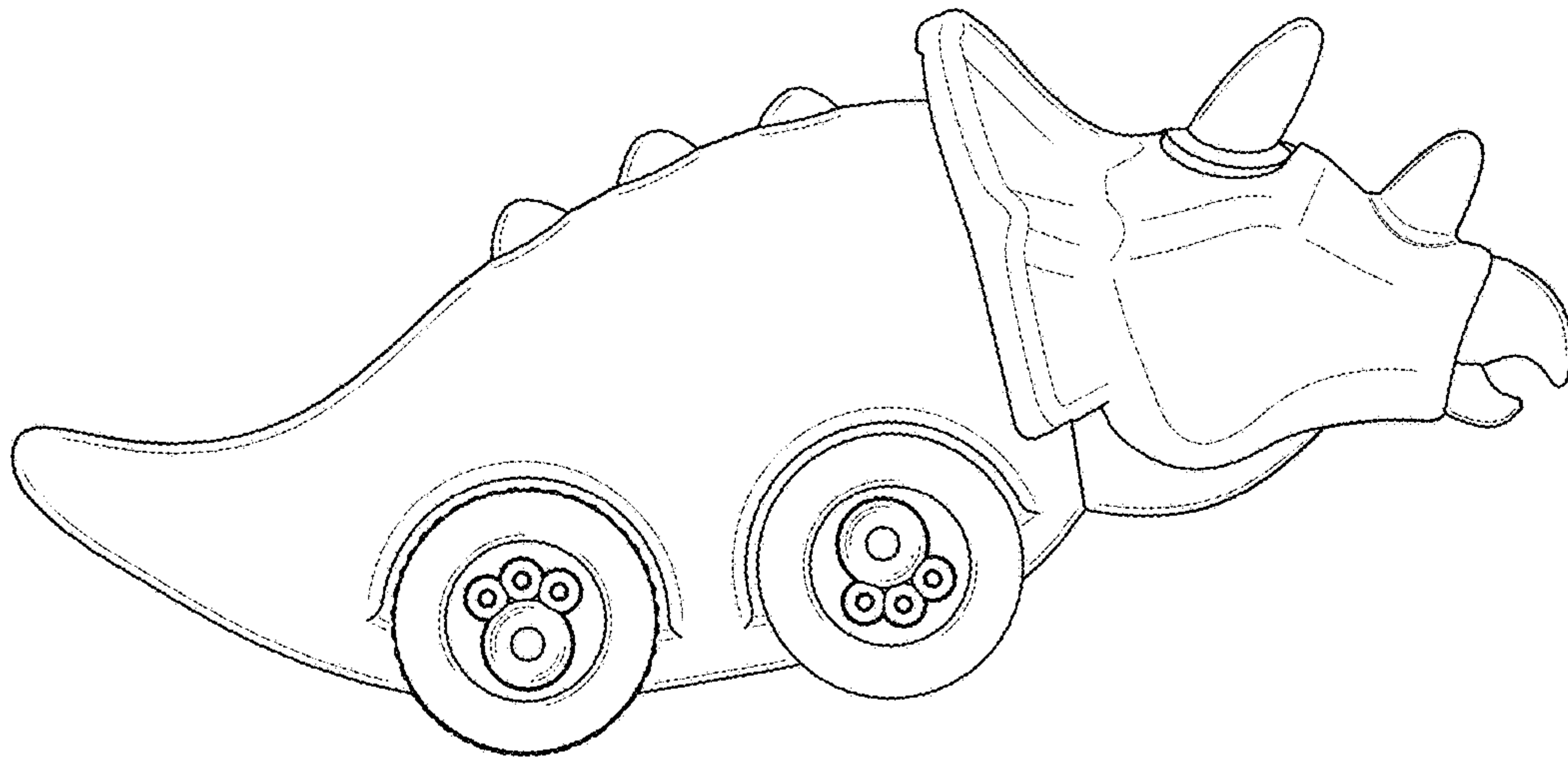

FIG. 31

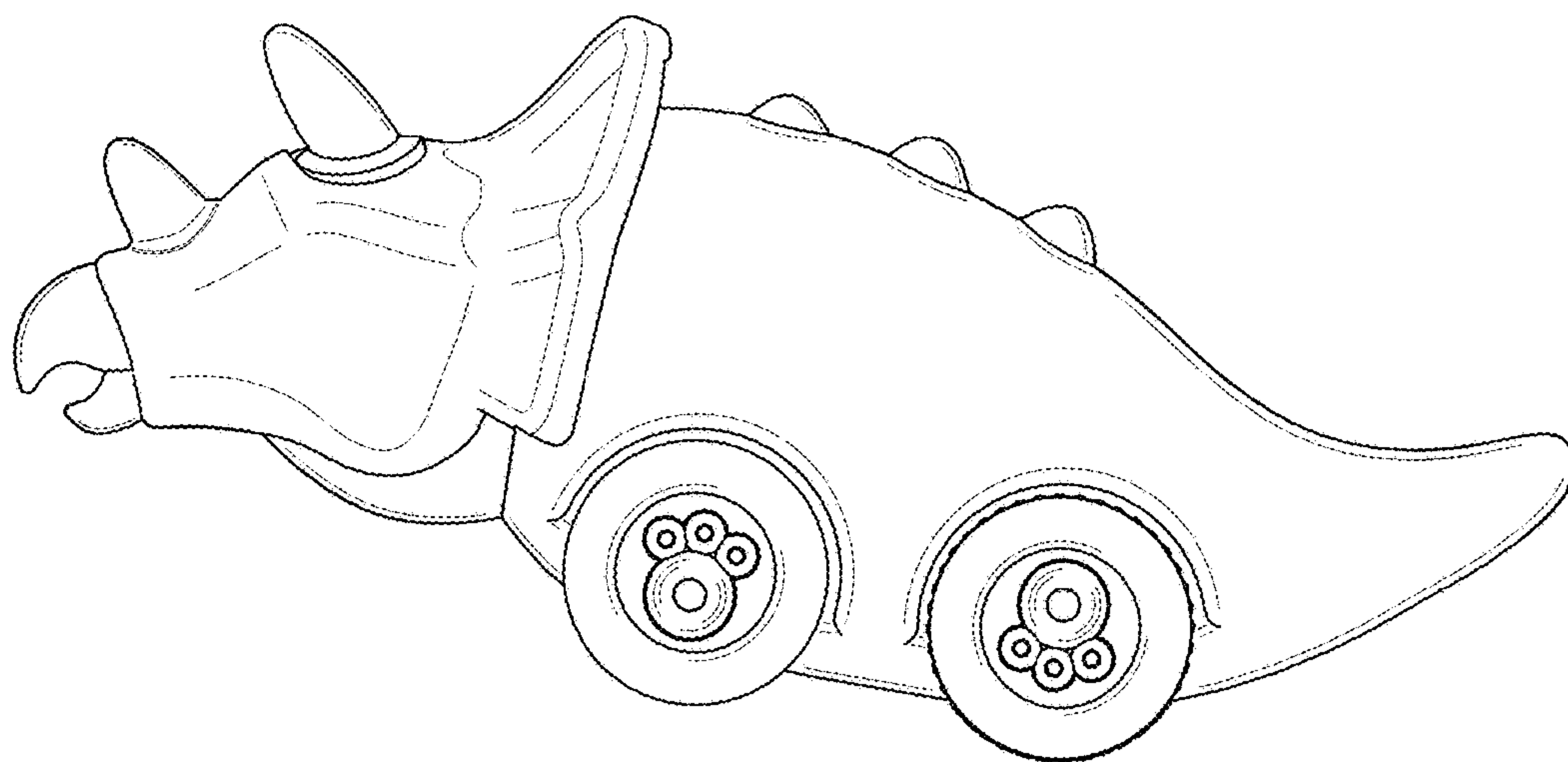

FIG. 32

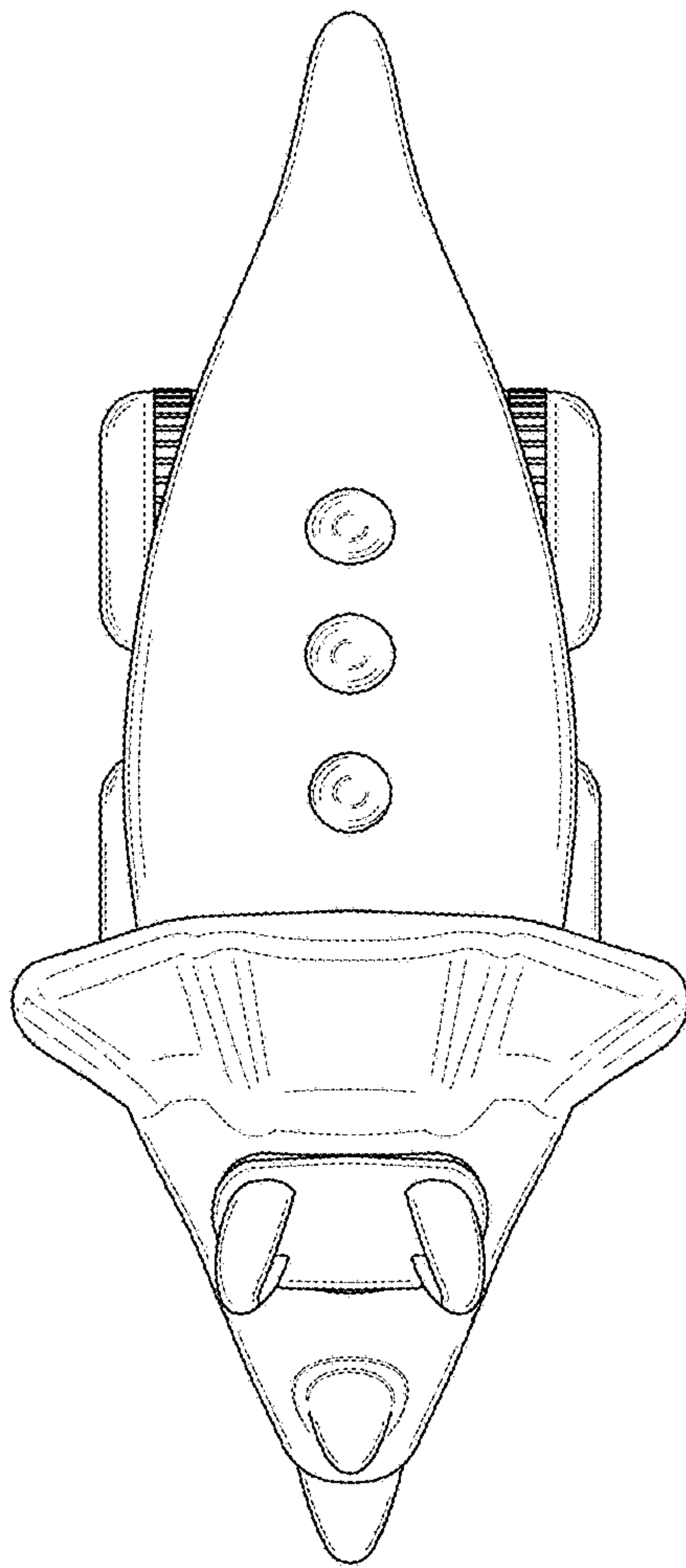

FIG. 33

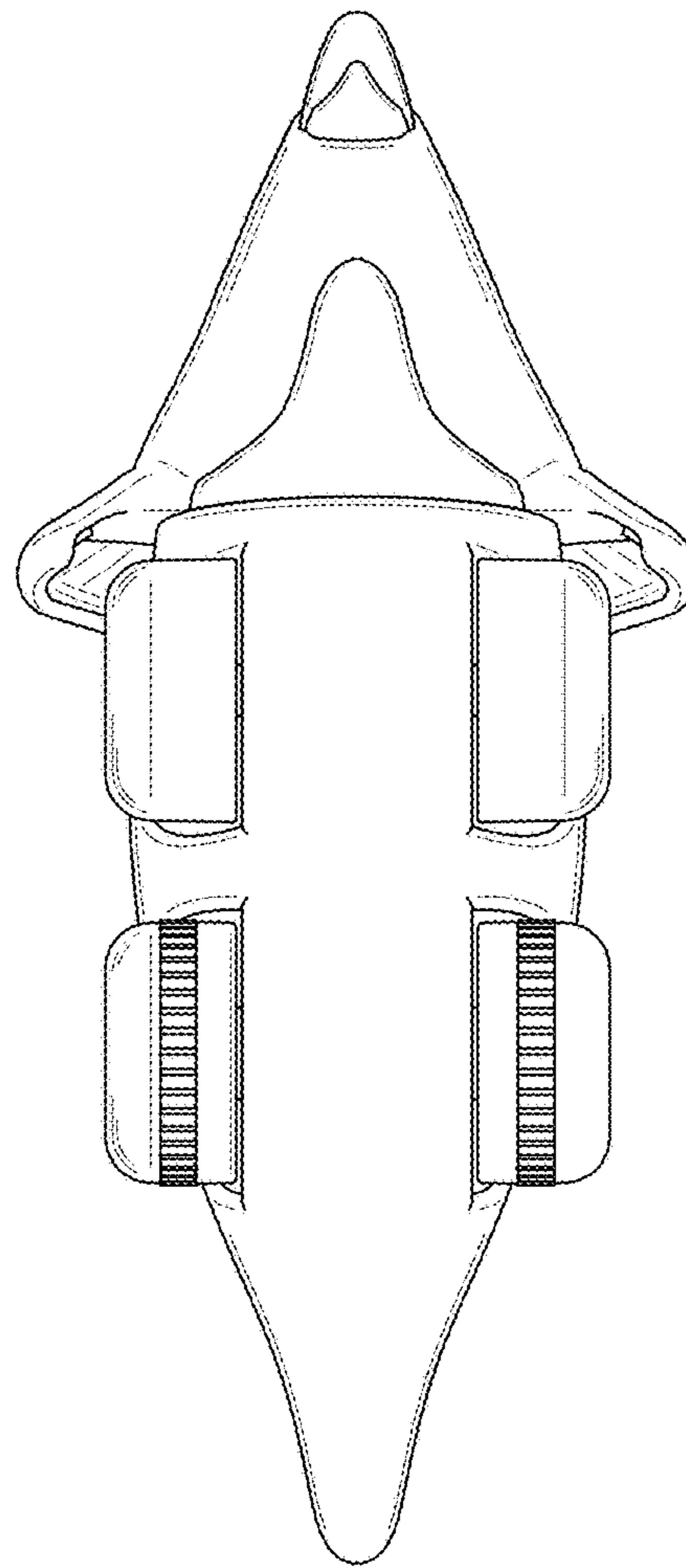

FIG. 34