



US00D819625S

(12) **United States Design Patent**  
**Michaelian et al.**

(10) **Patent No.:** **US D819,625 S**  
(45) **Date of Patent:** **\*\* Jun. 5, 2018**

(54) **SOUND SYSTEM FOR ELECTRONIC DEVICE**

**DESCRIPTION**

(71) Applicant: **Dolby Laboratories Licensing Corporation**, San Francisco, CA (US)

(72) Inventors: **Peter Michaelian**, Tappan, NY (US); **Grayson H. Byrd**, San Francisco, CA (US); **Christine Anna Naples**, San Francisco, CA (US)

(73) Assignee: **DOLBY LABORATORIES LICENSING CORPORATION**, San Francisco, CA (US)

(\*\*) Term: **15 Years**

(21) Appl. No.: **29/559,410**

(22) Filed: **Mar. 28, 2016**

(51) **LOC (11) Cl.** ..... **14-02**

(52) **U.S. Cl.**  
USPC ..... **D14/315**

(58) **Field of Classification Search**  
USPC .... D14/315-327, 172, 204, 209.1, 210, 214, D14/215, 261, 221; D18/1, 2, 7, 11;  
(Continued)

(56) **References Cited**

**U.S. PATENT DOCUMENTS**

5,708,561 A \* 1/1998 Huilgol ..... G06F 1/1616  
361/679.07  
5,917,695 A \* 6/1999 Youn ..... G06F 1/1616  
345/905

(Continued)

*Primary Examiner* — Freda S Nunn

(74) *Attorney, Agent, or Firm* — McAndrews, Held & Malloy, Ltd.

(57) **CLAIM**

The ornamental design for a sound system for electronic device, as shown and described.

FIG. 1 is a front perspective view of a first embodiment of a sound system for electronic device showing our new design;

FIG. 2 is a front elevation view thereof;

FIG. 3 is a rear elevation view thereof;

FIG. 4 is a right-side elevation view thereof;

FIG. 5 is a left-side elevation view thereof;

FIG. 6 is a top plan view thereof;

FIG. 7 is a bottom plan view thereof;

FIG. 8 is a rear perspective view thereof;

FIG. 9 is an enlarged front perspective view of the portion encircled in FIG. 1;

FIG. 10 is an enlarged rear perspective view of the portion encircled in FIG. 8;

FIG. 11 is an enlarged rear perspective view of the portion encircled in FIG. 8;

FIG. 12 is a front perspective view of a second embodiment of a sound system for electronic device showing our new design;

FIG. 13 is a front elevation view thereof;

FIG. 14 is a rear elevation view thereof;

FIG. 15 is a right-side elevation view thereof;

FIG. 16 is a left-side elevation view thereof;

FIG. 17 is a top plan view thereof;

FIG. 18 is a bottom plan view thereof;

FIG. 19 is a rear perspective view thereof;

FIG. 20 is an enlarged front perspective view of the portion encircled in FIG. 12;

FIG. 21 is an enlarged rear perspective view of the portion encircled in FIG. 19; and,

FIG. 22 is an enlarged rear perspective view of the portion encircled in FIG. 19.

The dashed broken lines in the drawings show environment and portions of the sound system for electronic device that form no part of the claimed design.

The dot-dash broken lines in the drawings encircle portions of the claimed design that are illustrated in enlargements and form no part of the claimed design.

**1 Claim, 22 Drawing Sheets**

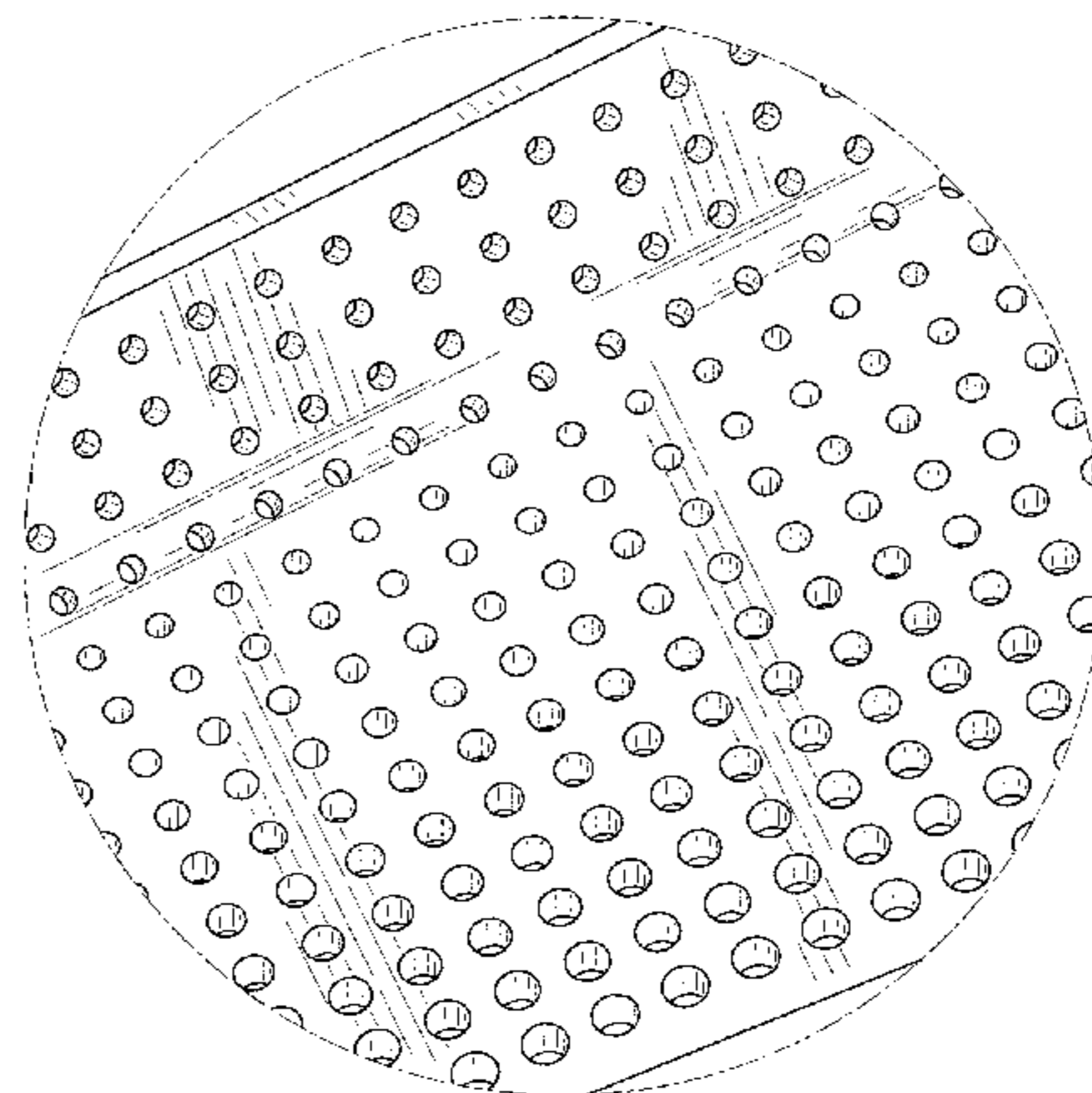
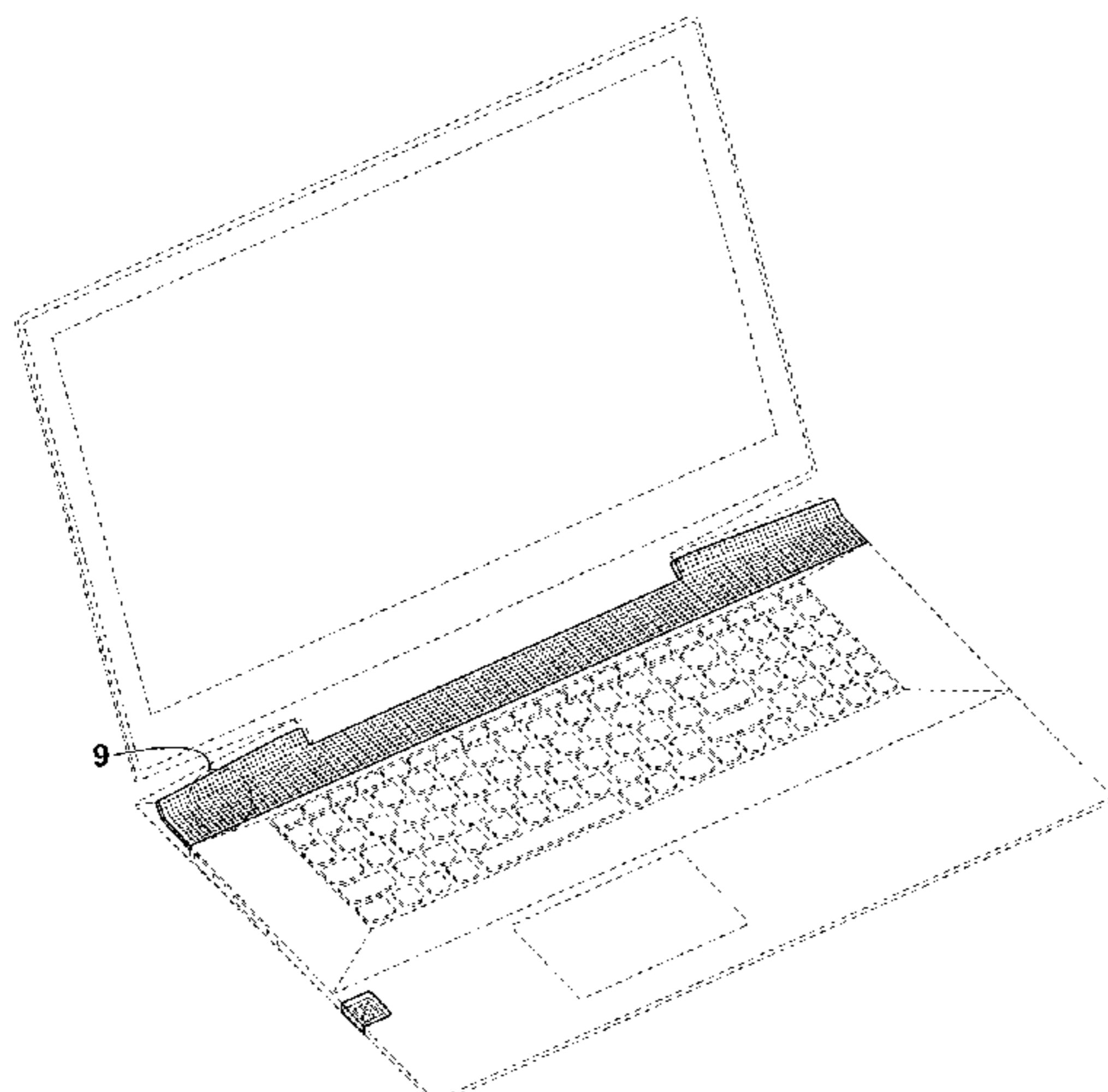

# US D819,625 S

Page 2

## (58) Field of Classification Search

USPC ..... 235/145 A, 145 R; 341/22, 23; 345/104,  
345/156, 168, 169, 173; 361/679.08,  
361/679.09, 679.11, 679.26, 679.27

CPC ..... G06F 1/16; G06F 1/1616; G06F 1/1626;  
G06F 1/1632; G06F 1/1613; G06F  
1/1601; G06F 1/1618; G06F 1/162; G06F  
1/166; G06F 1/1654; G06F 1/1681; G06F  
1/1637; G06F 1/1688; G06F 1/1656;  
H01R 35/02; H03M 11/00; G09B 13/04;  
H03K 17/94; G09G 5/00; F16M 11/10;  
H05K 5/00; H05K 1/16; H04M 1/0237;  
H04R 1/02; H04R 5/02; H04R 1/023;  
H04R 1/00; H04R 1/2857; H04B 1/00;  
H01Q 1/243

See application file for complete search history.

## (56)

## References Cited

### U.S. PATENT DOCUMENTS

6,657,854	B2 *	12/2003	Horii .....	G06F 1/1616 361/679.09
6,697,495	B1 *	2/2004	Youn .....	G06F 1/1616 381/306
6,744,623	B2 *	6/2004	Numano .....	G06F 1/1632 345/87
D630,626	S *	1/2011	Fujita .....	D14/318
8,170,266	B2 *	5/2012	Hopkinson .....	H04R 1/023 361/679.01
D706,759	S *	6/2014	Myung .....	D14/315
8,976,992	B2 *	3/2015	Loo .....	H04R 1/2857 381/333
D734,318	S *	7/2015	Lee .....	D14/315
D736,199	S *	8/2015	Hirano .....	D14/315
2003/0223610	A1 *	12/2003	Tanemura .....	H04R 1/00 381/334

\* cited by examiner

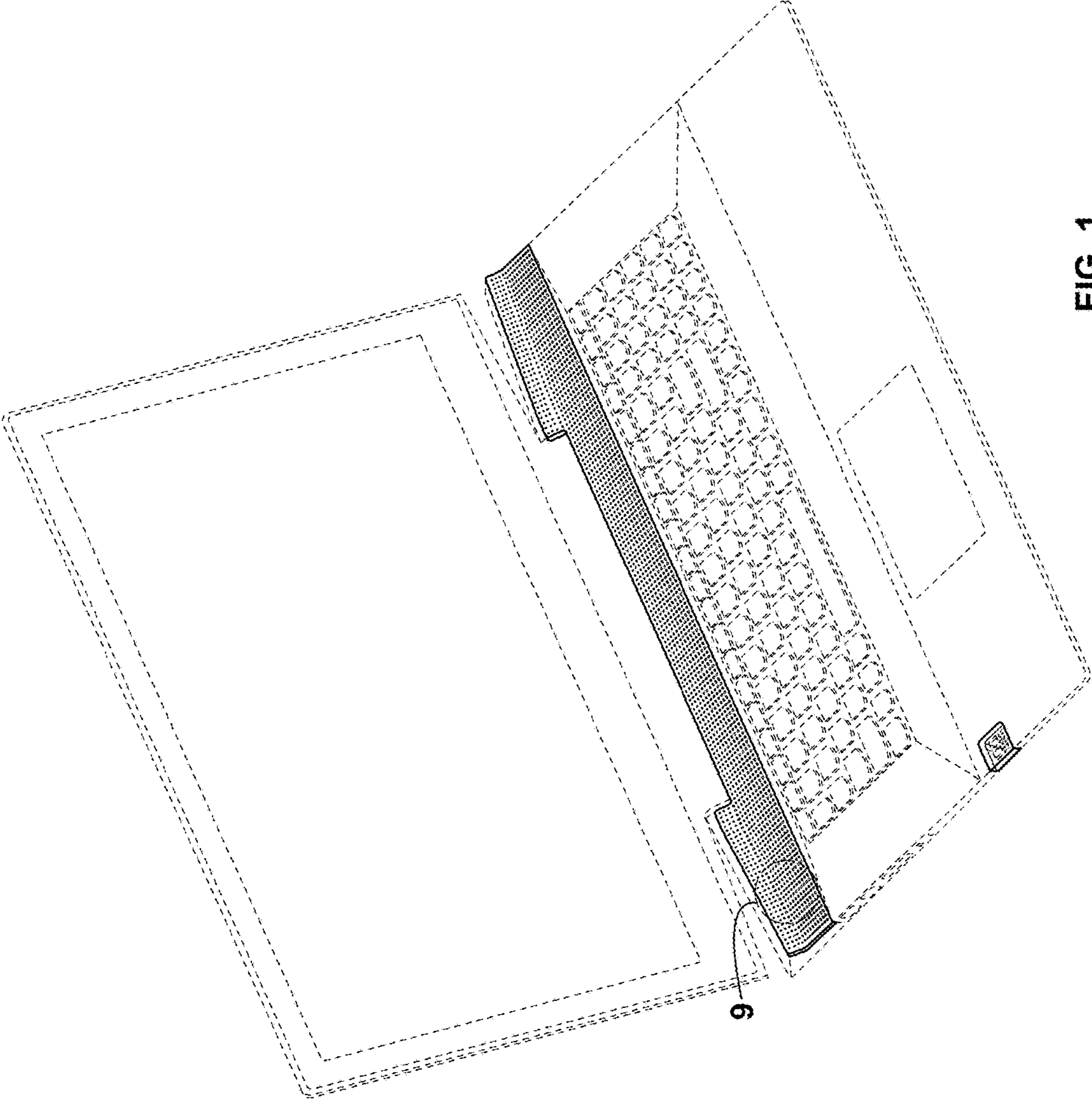

FIG. 1

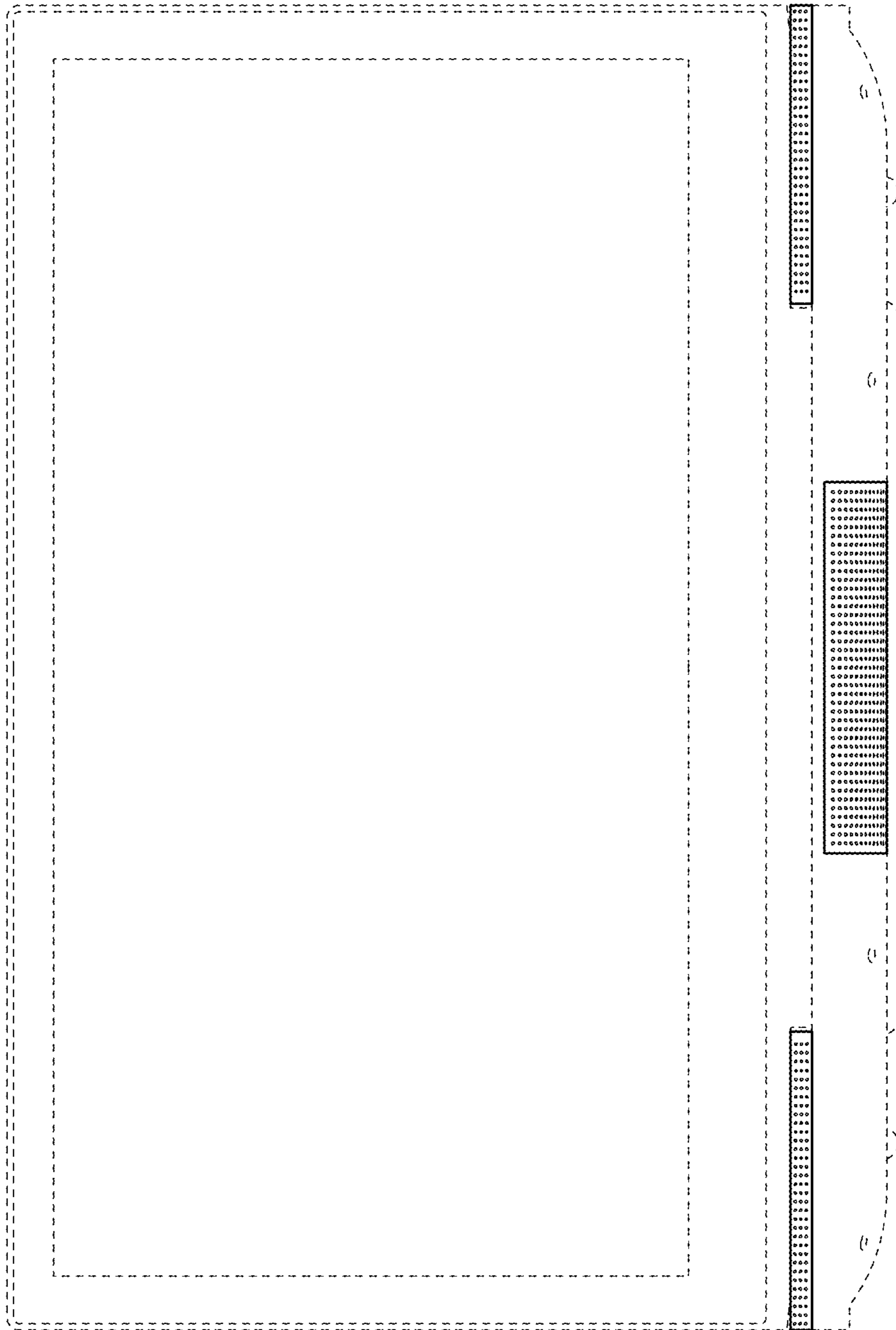

FIG. 2

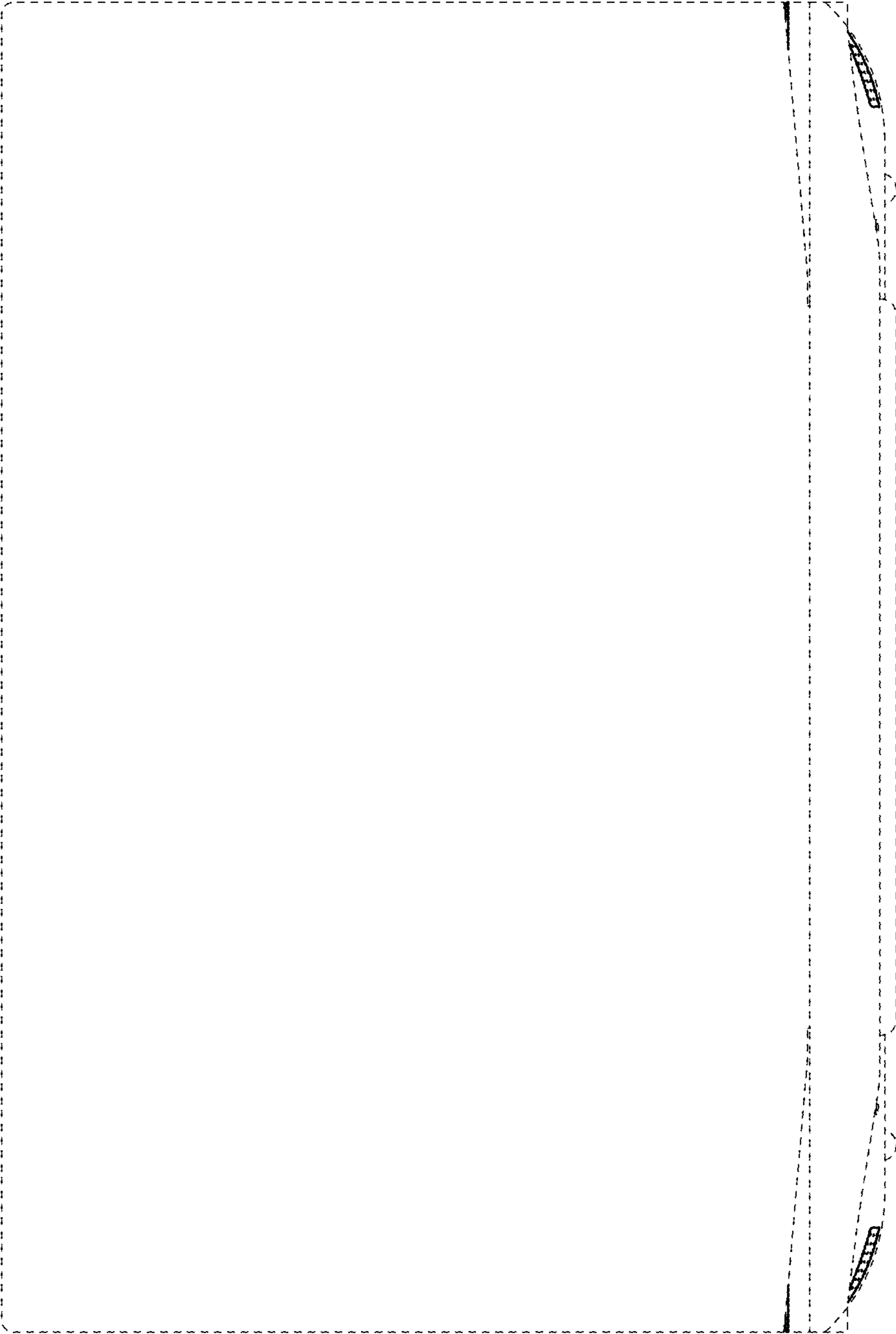

FIG. 3

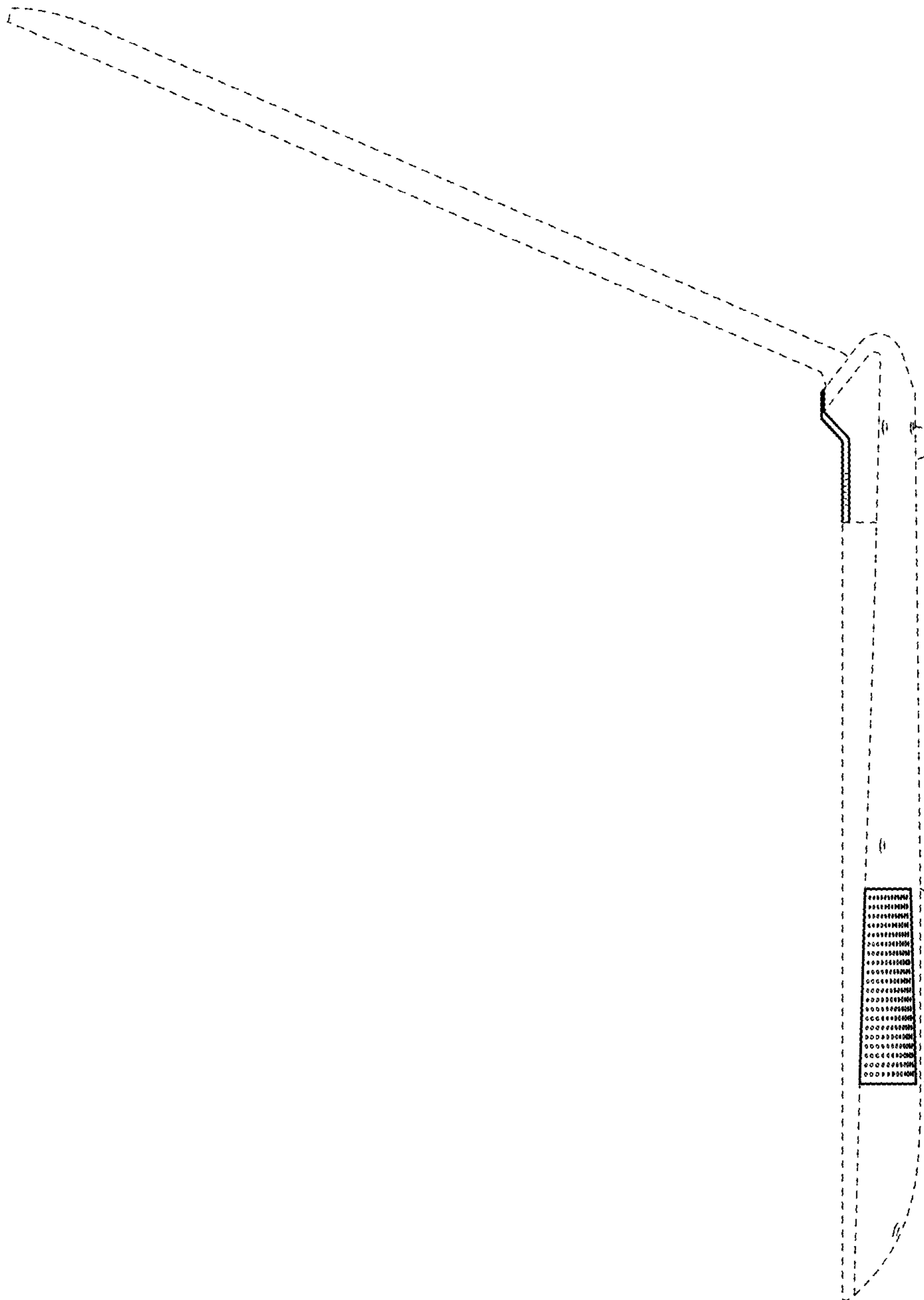

FIG. 4

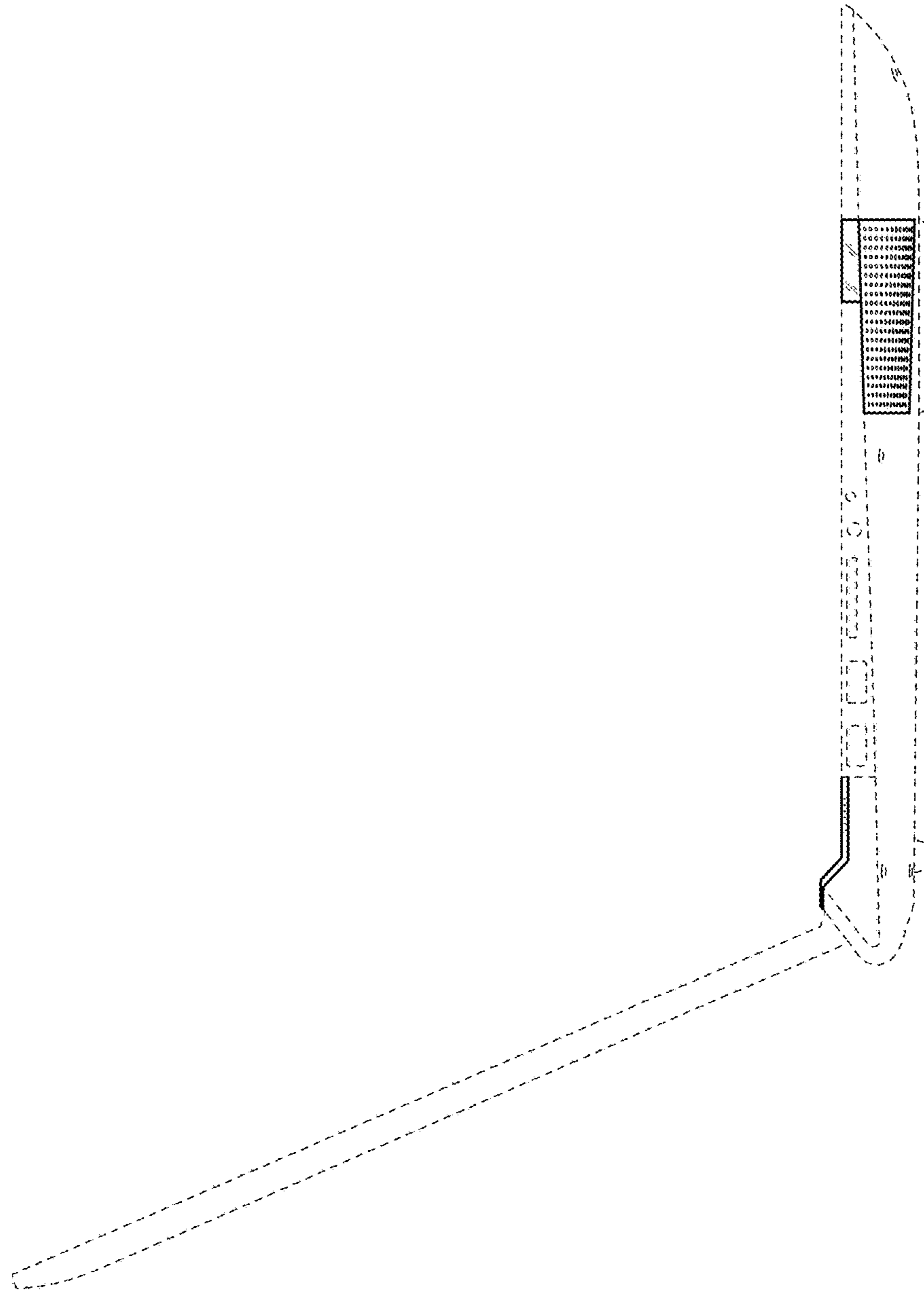

FIG. 5

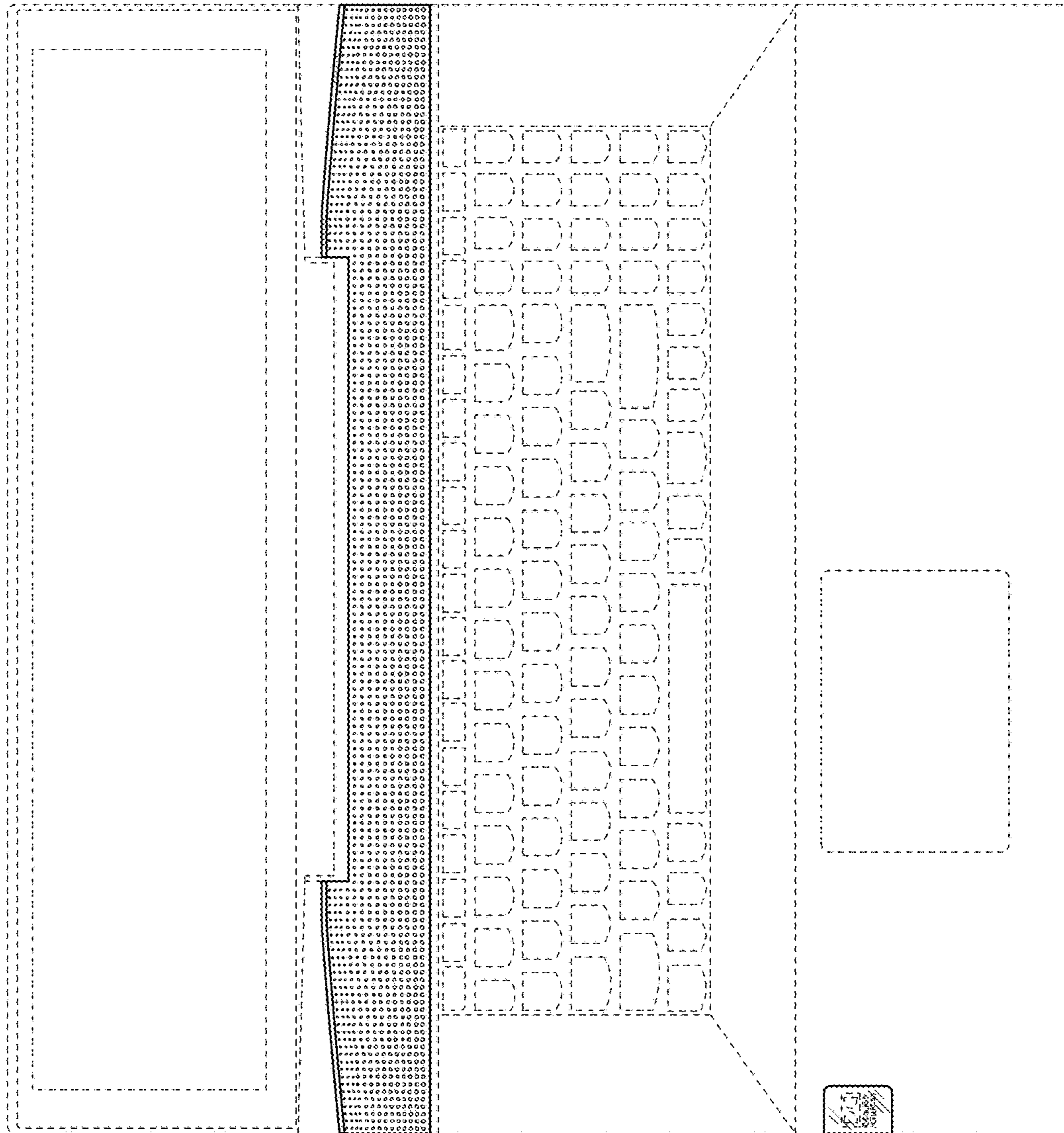

FIG. 6



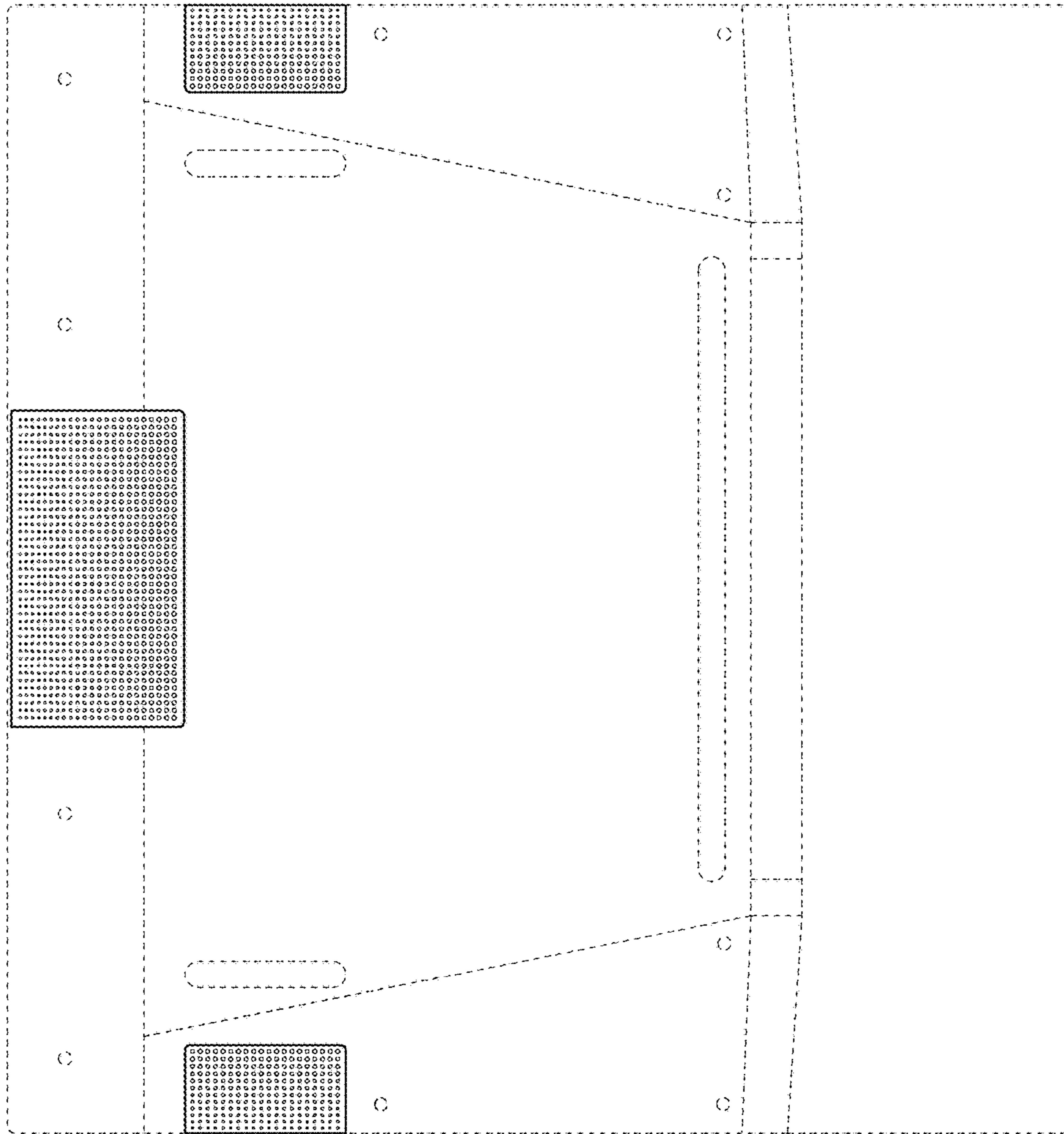

FIG. 7

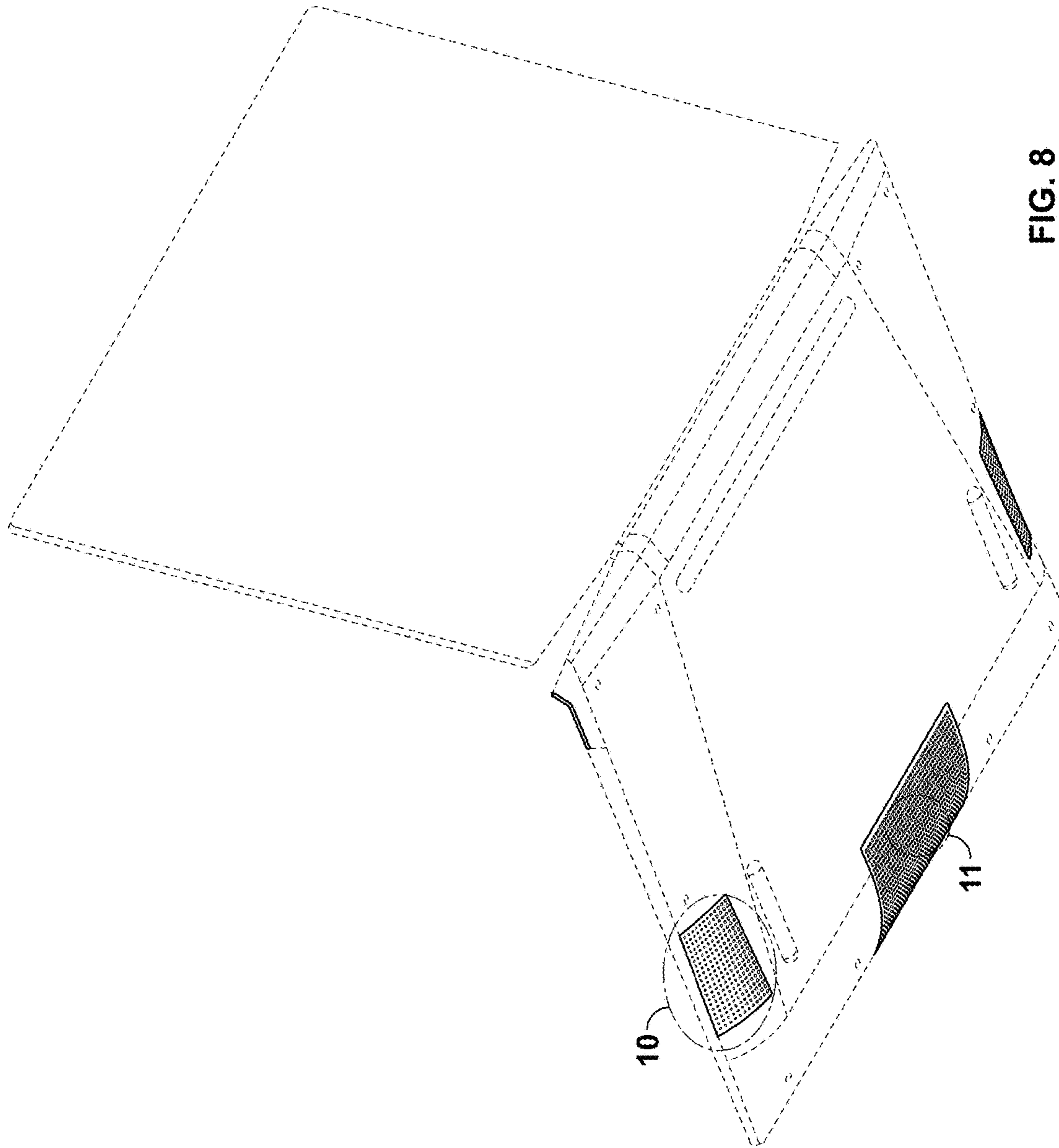

FIG. 8

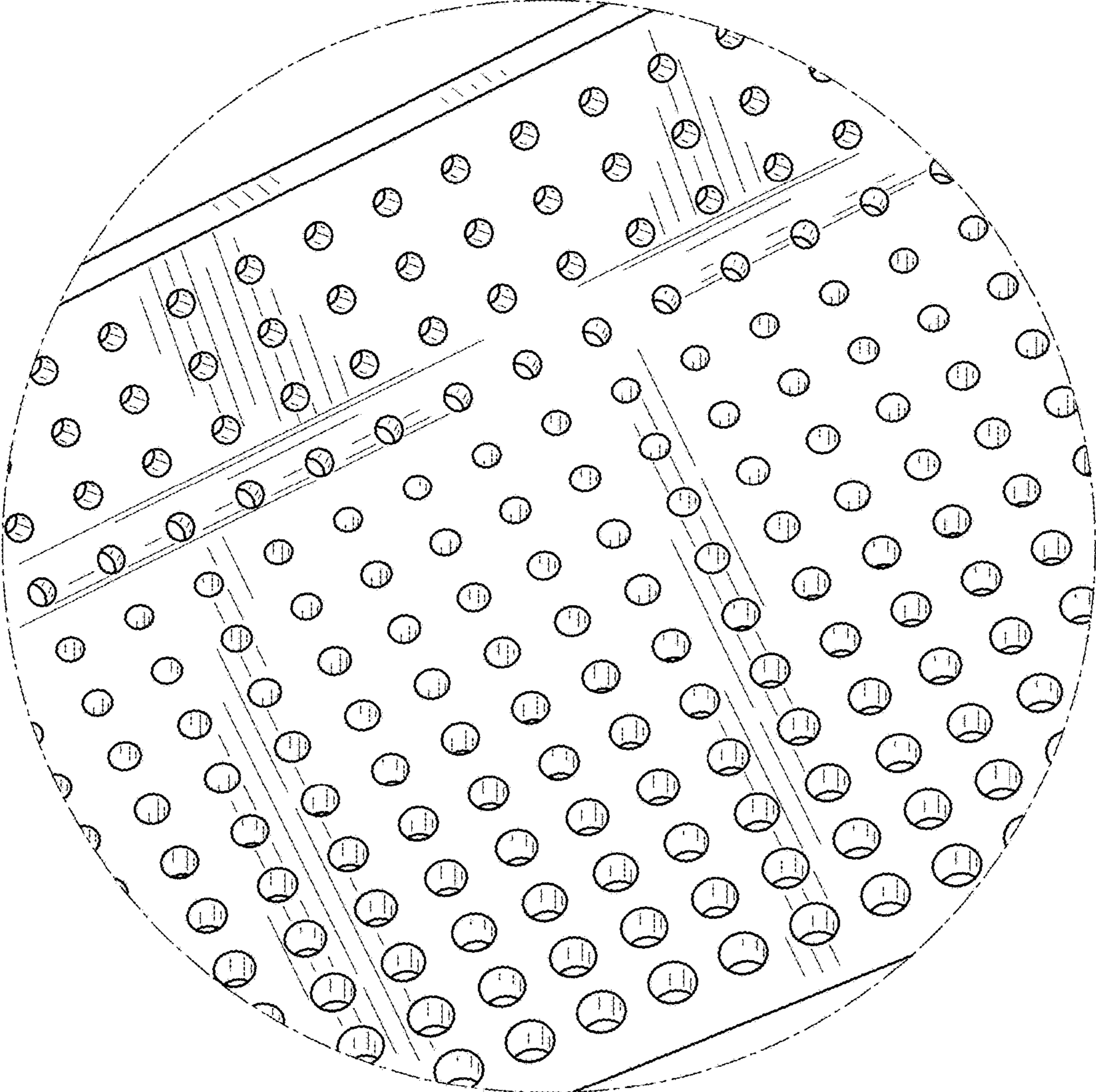

FIG. 9

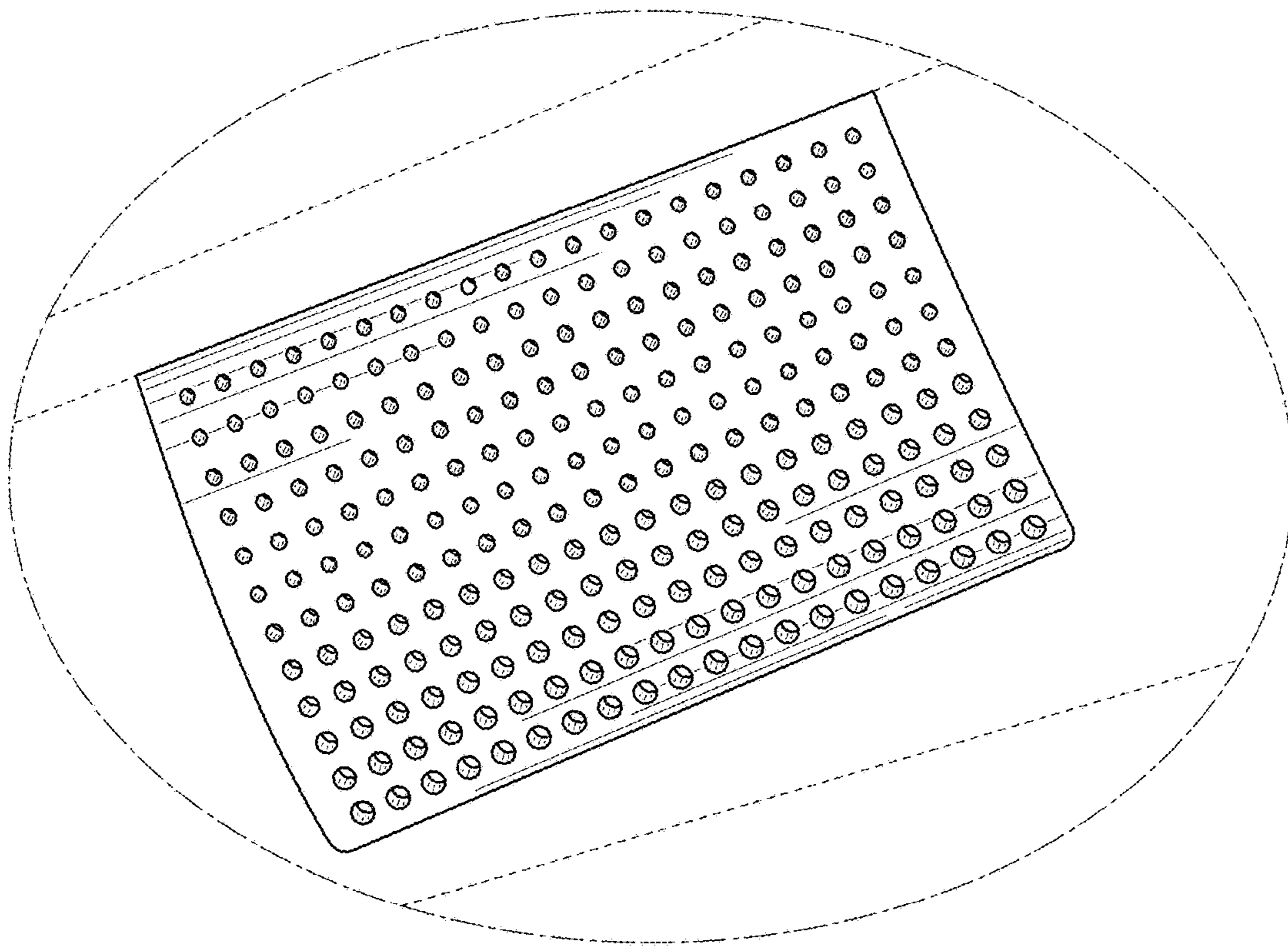

FIG. 10

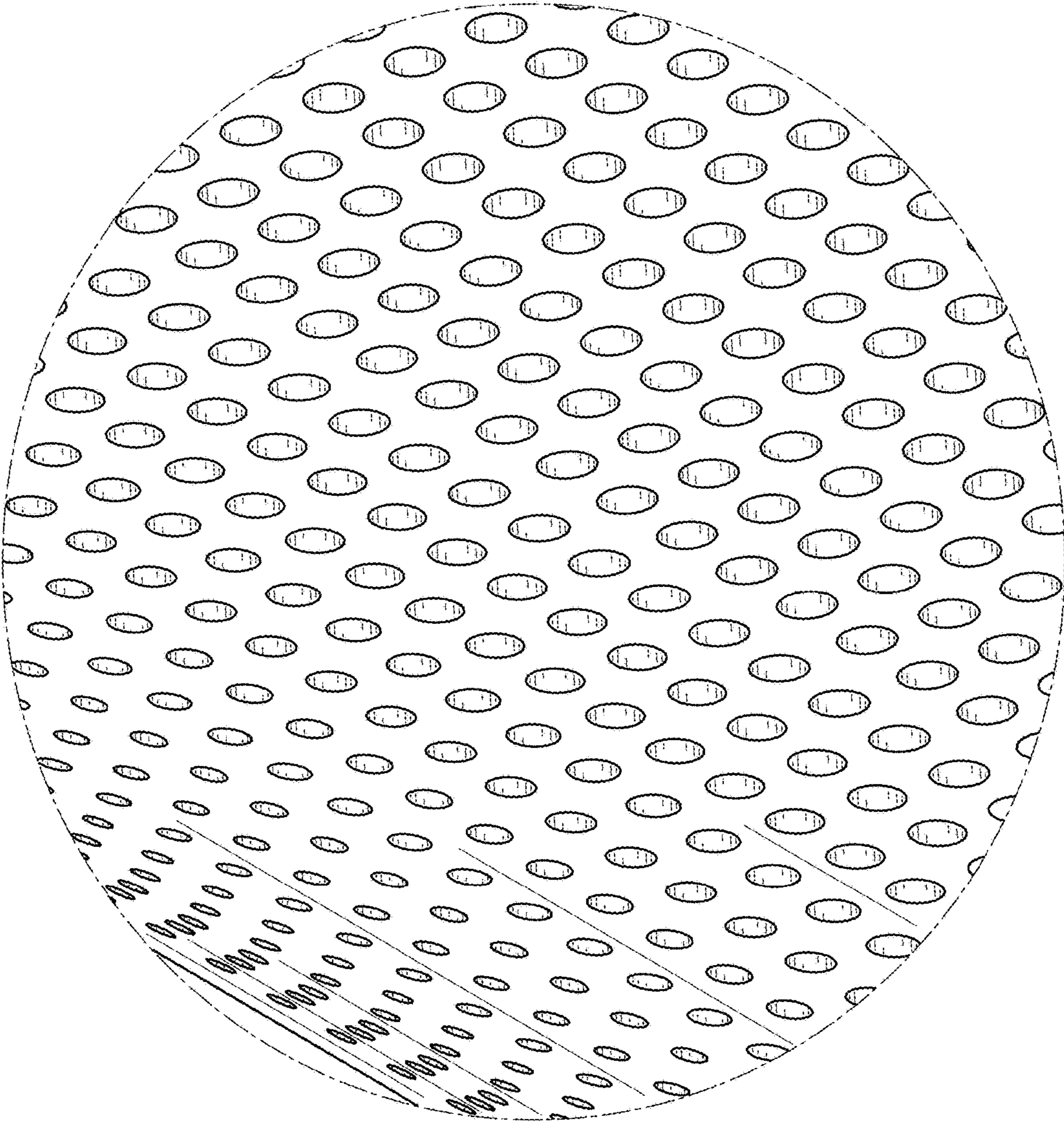

FIG. 11

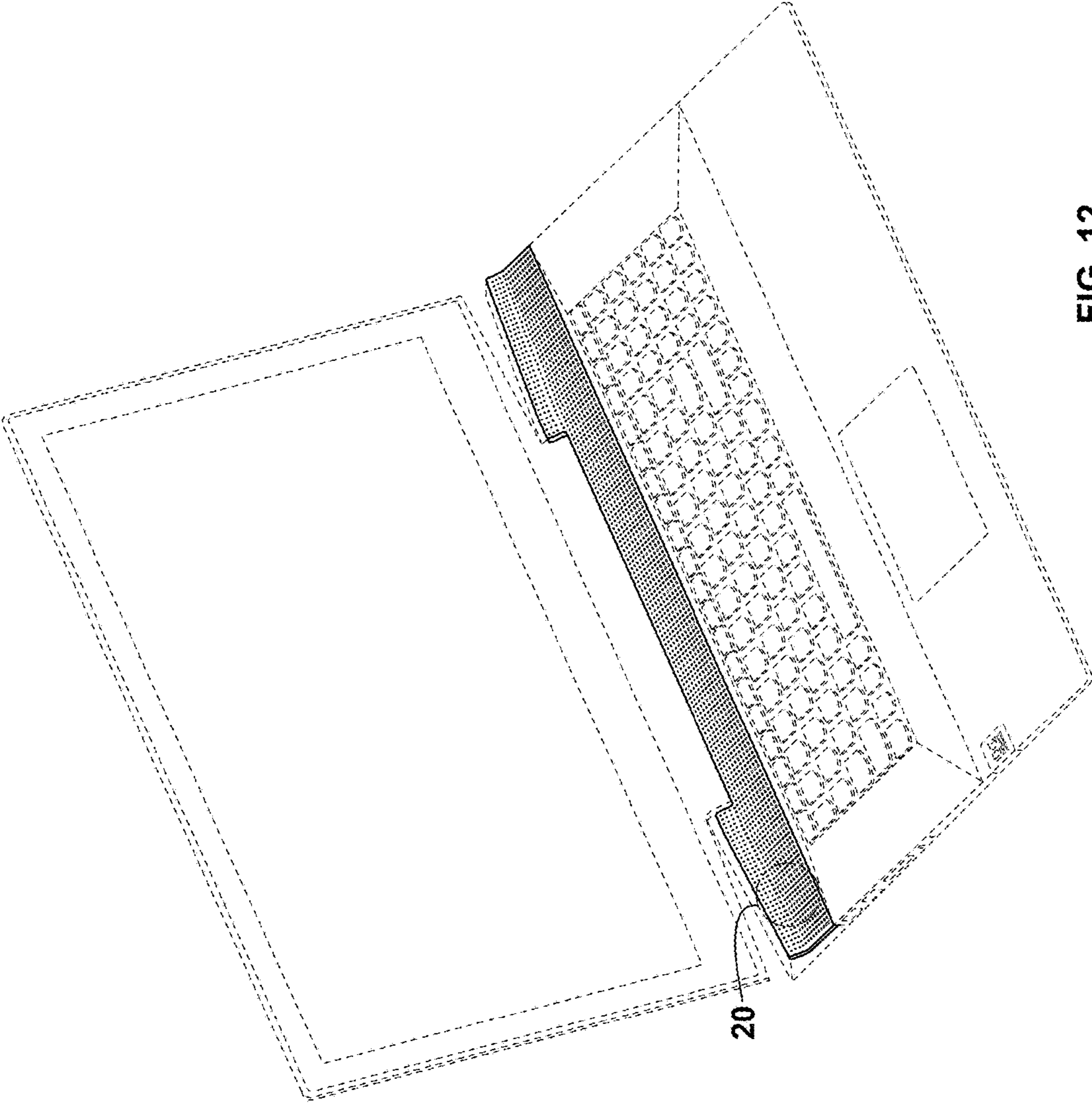

FIG. 12

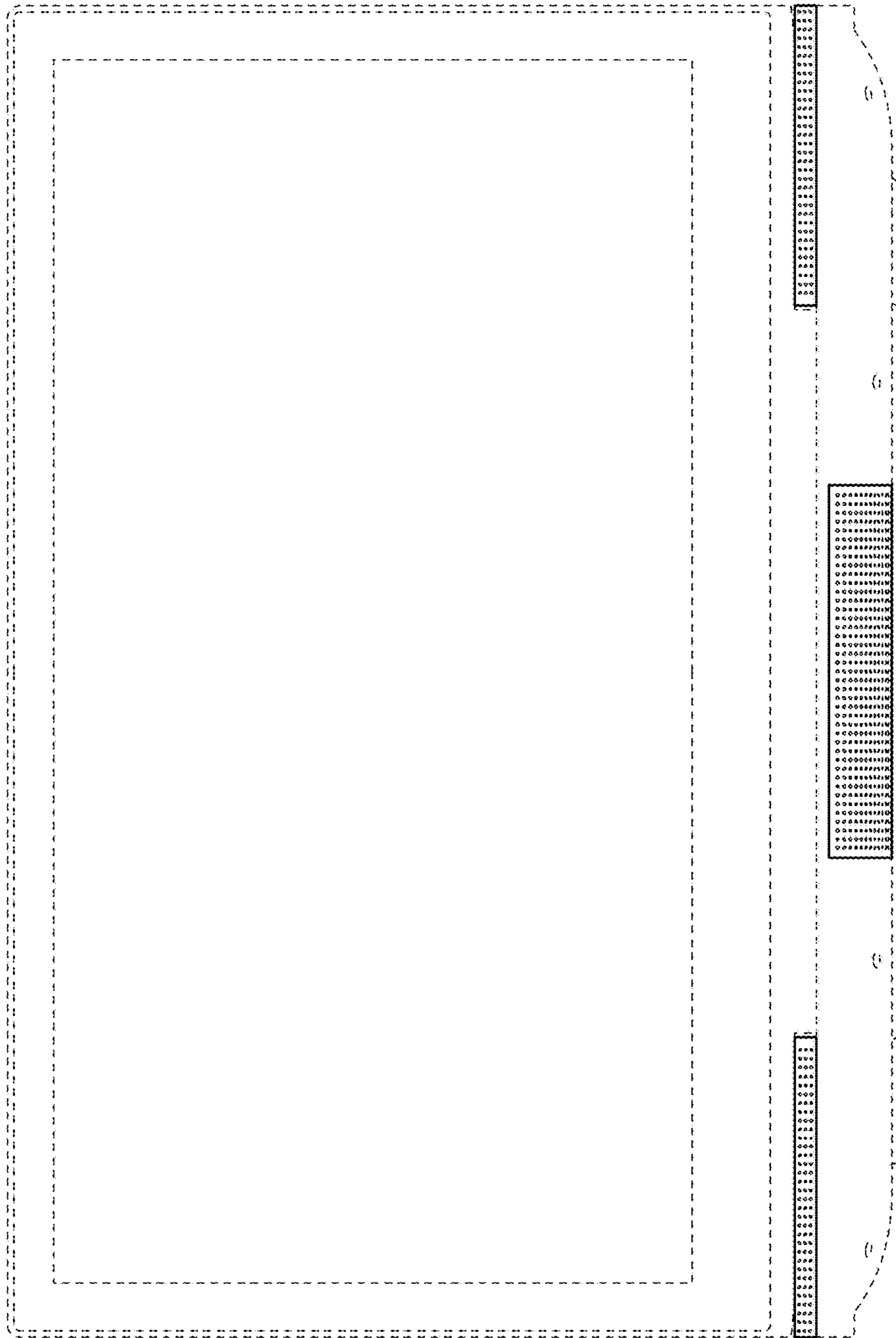

FIG. 13

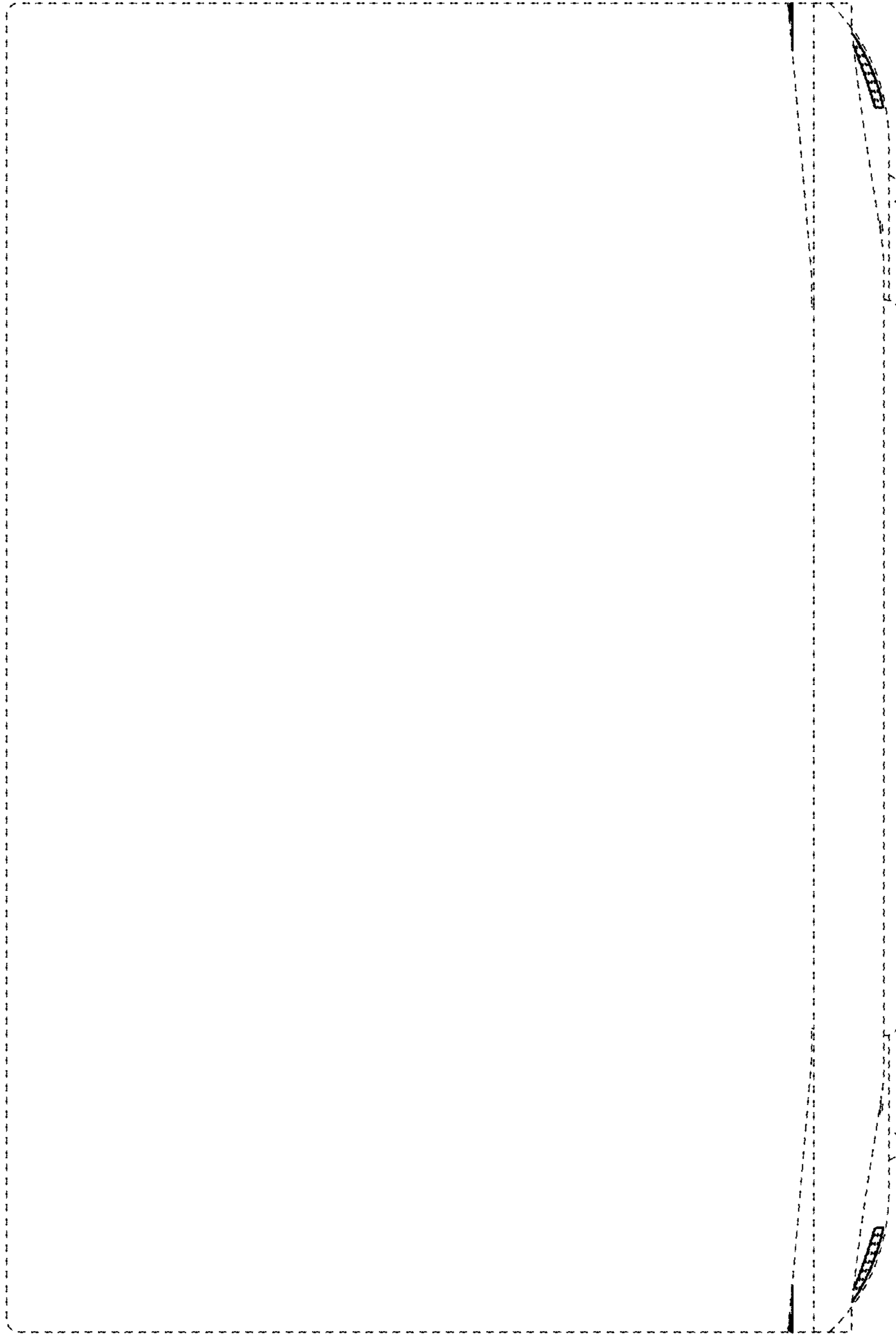

FIG. 14



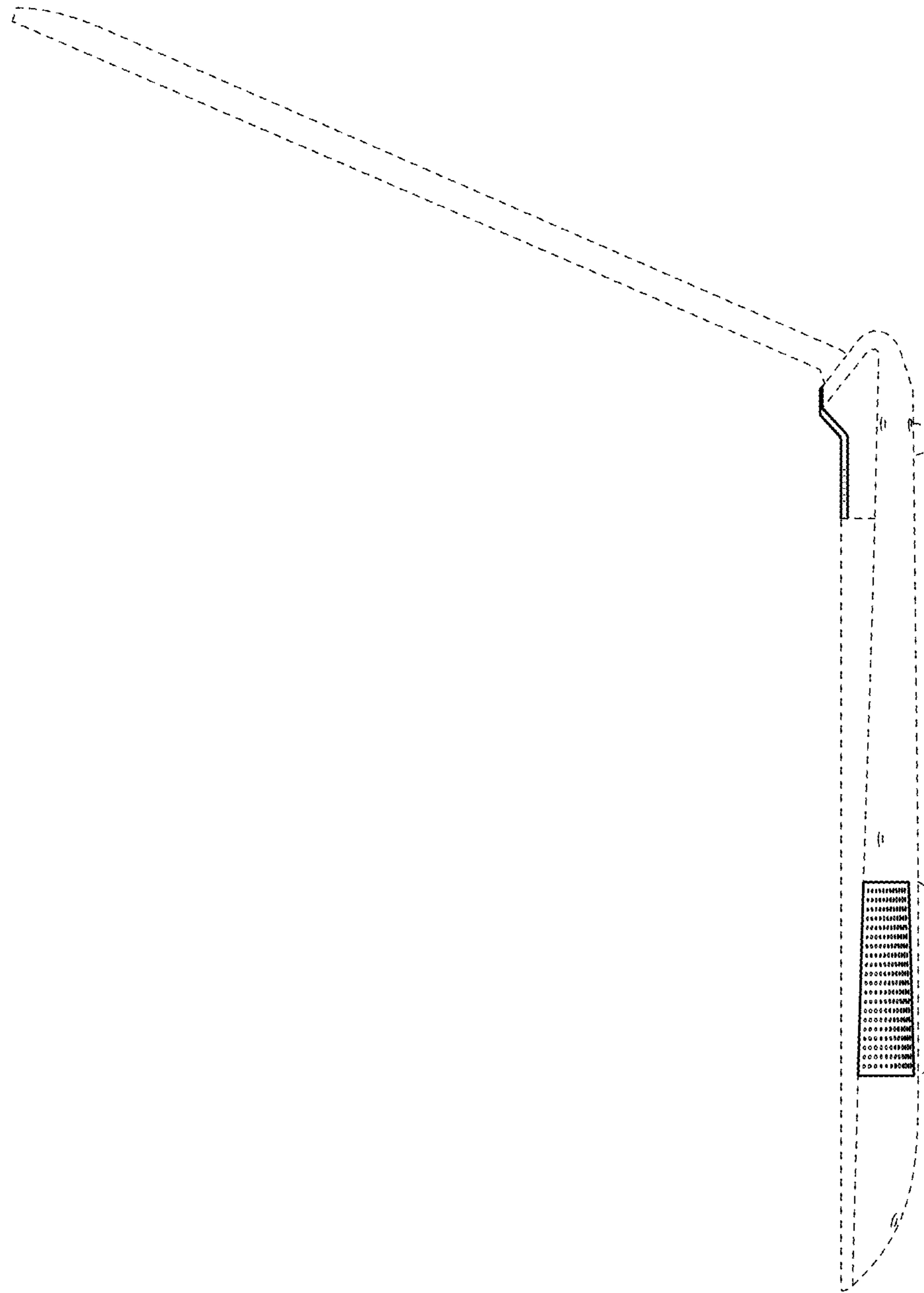

FIG. 15

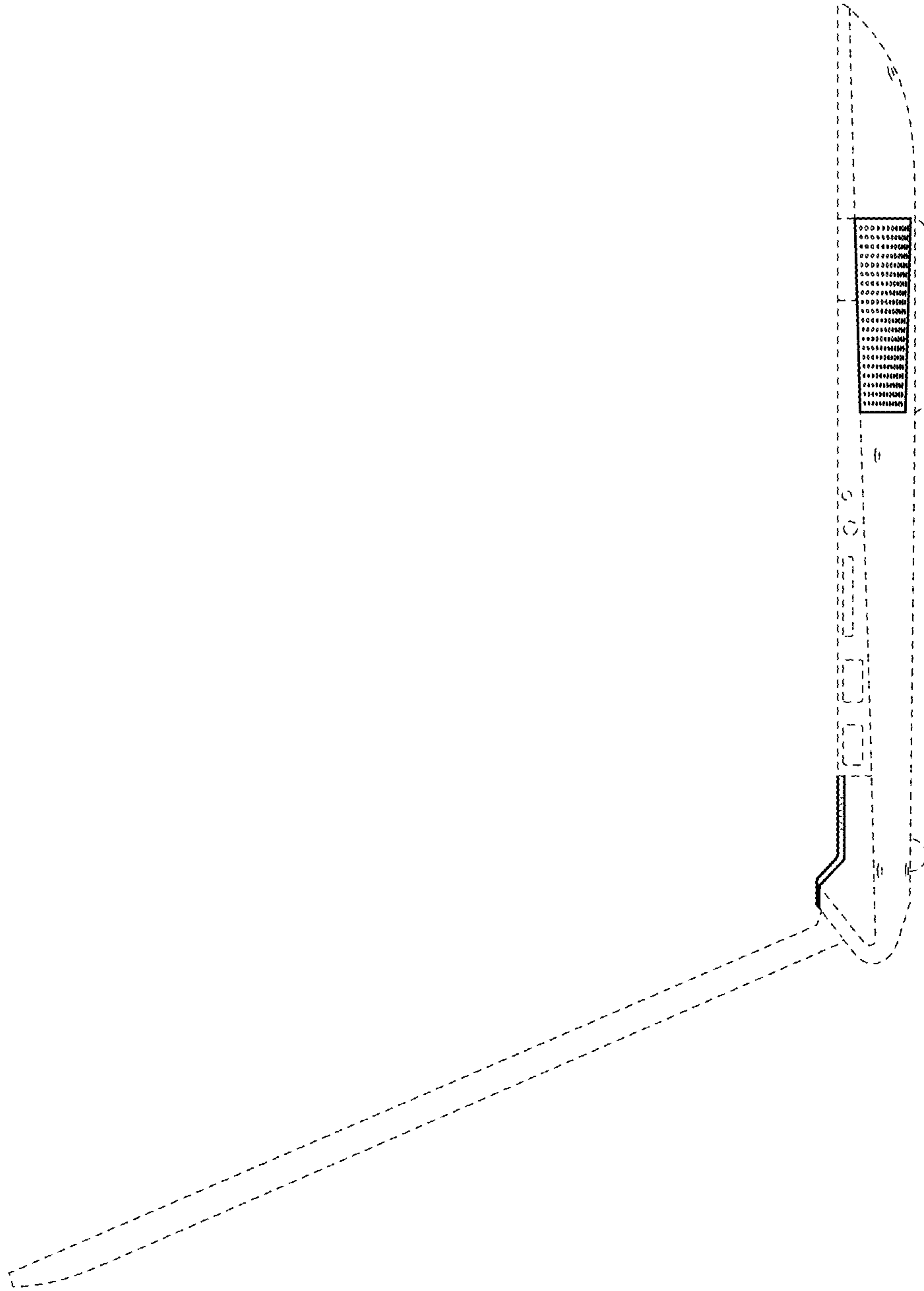

FIG. 16

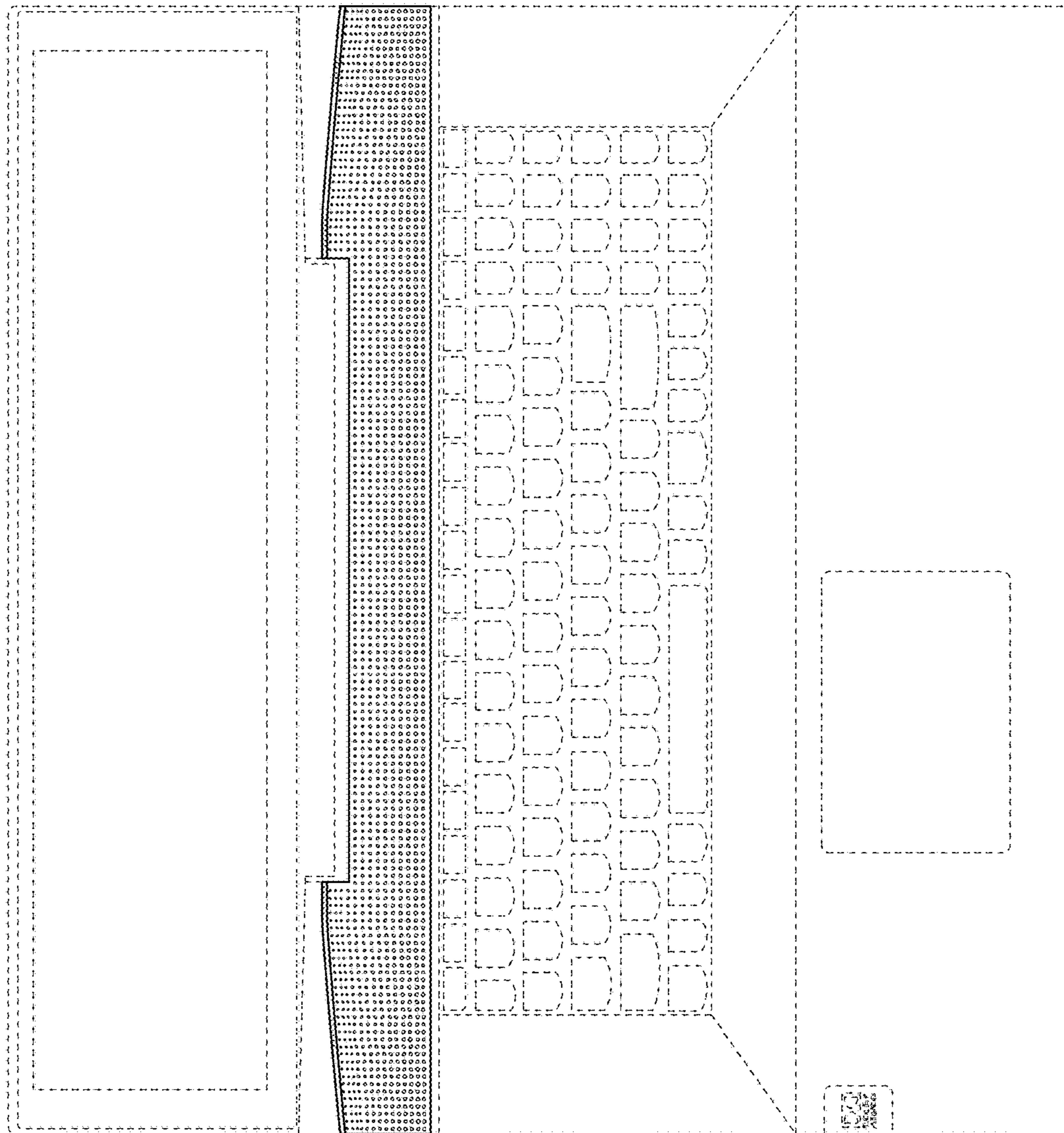

FIG. 17

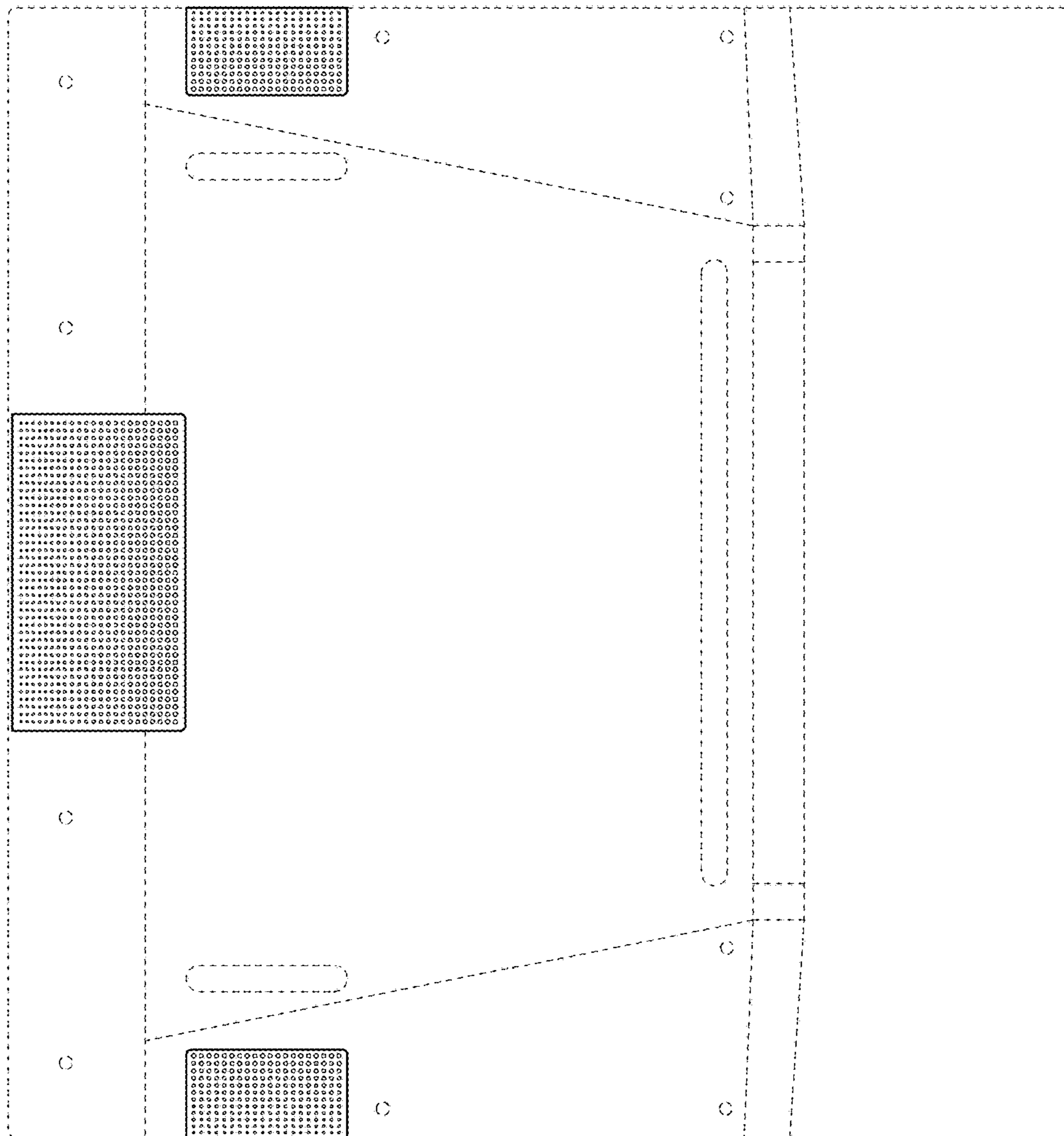

FIG. 18

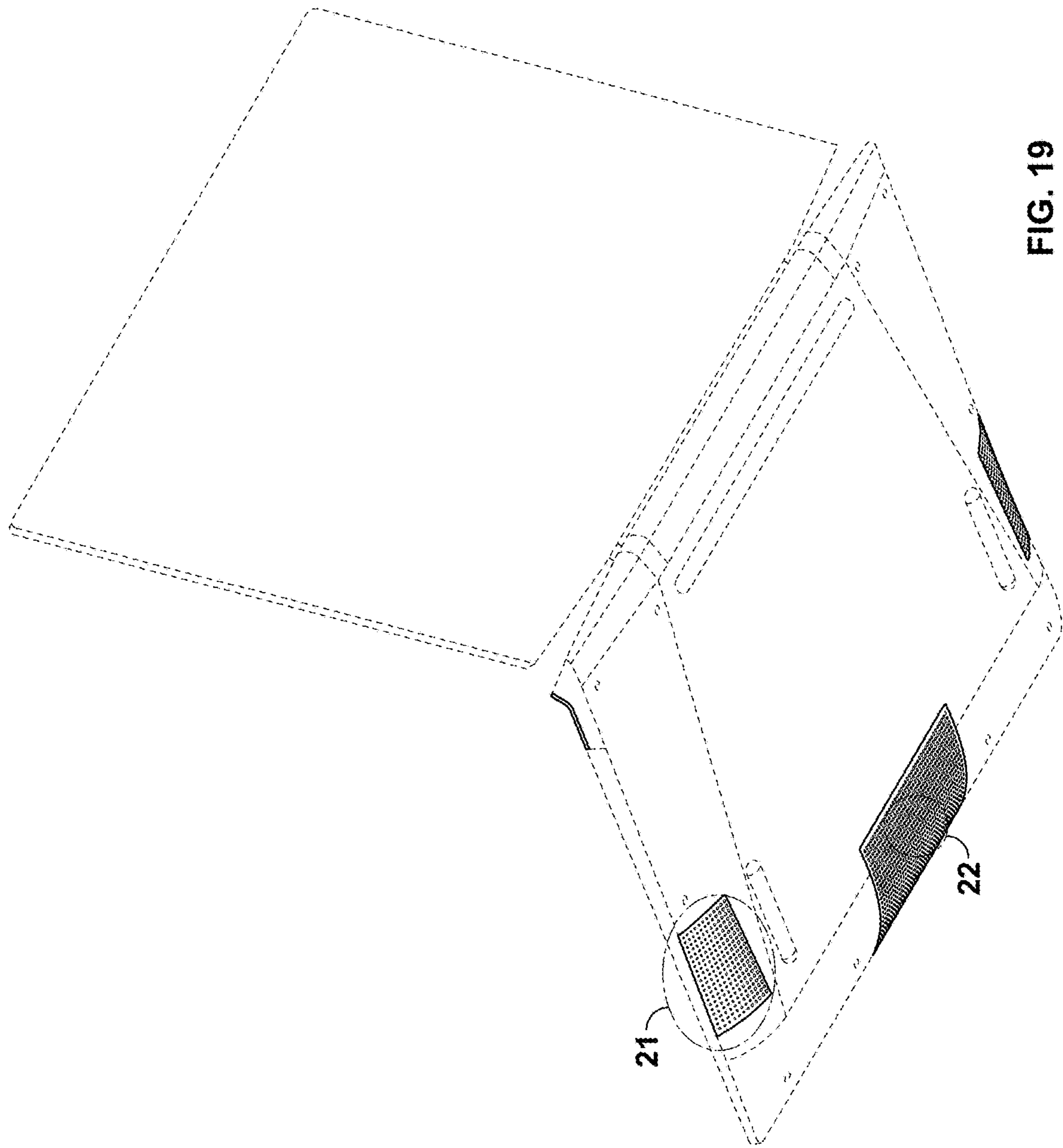

FIG. 19

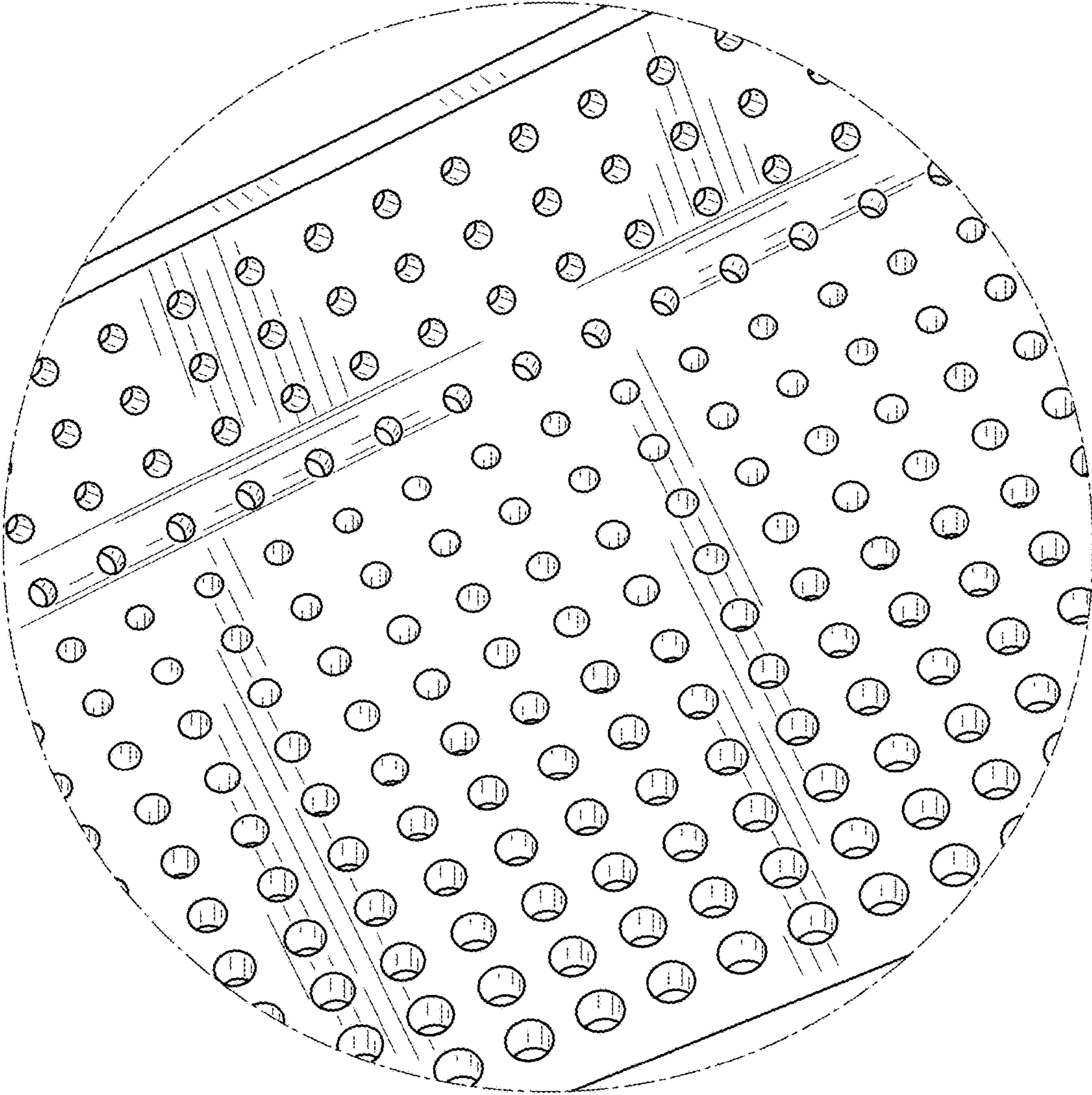

FIG. 20

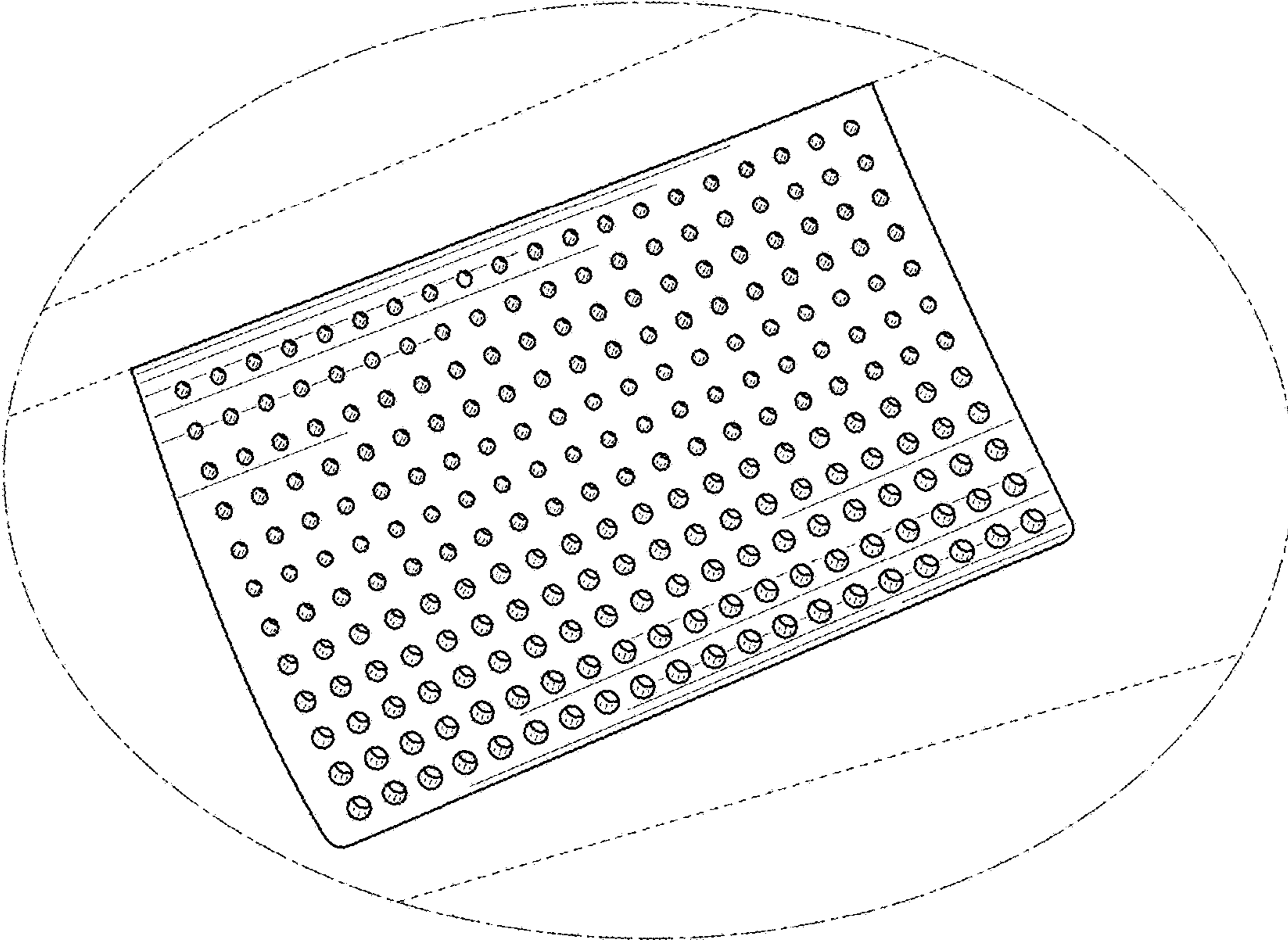

FIG. 21

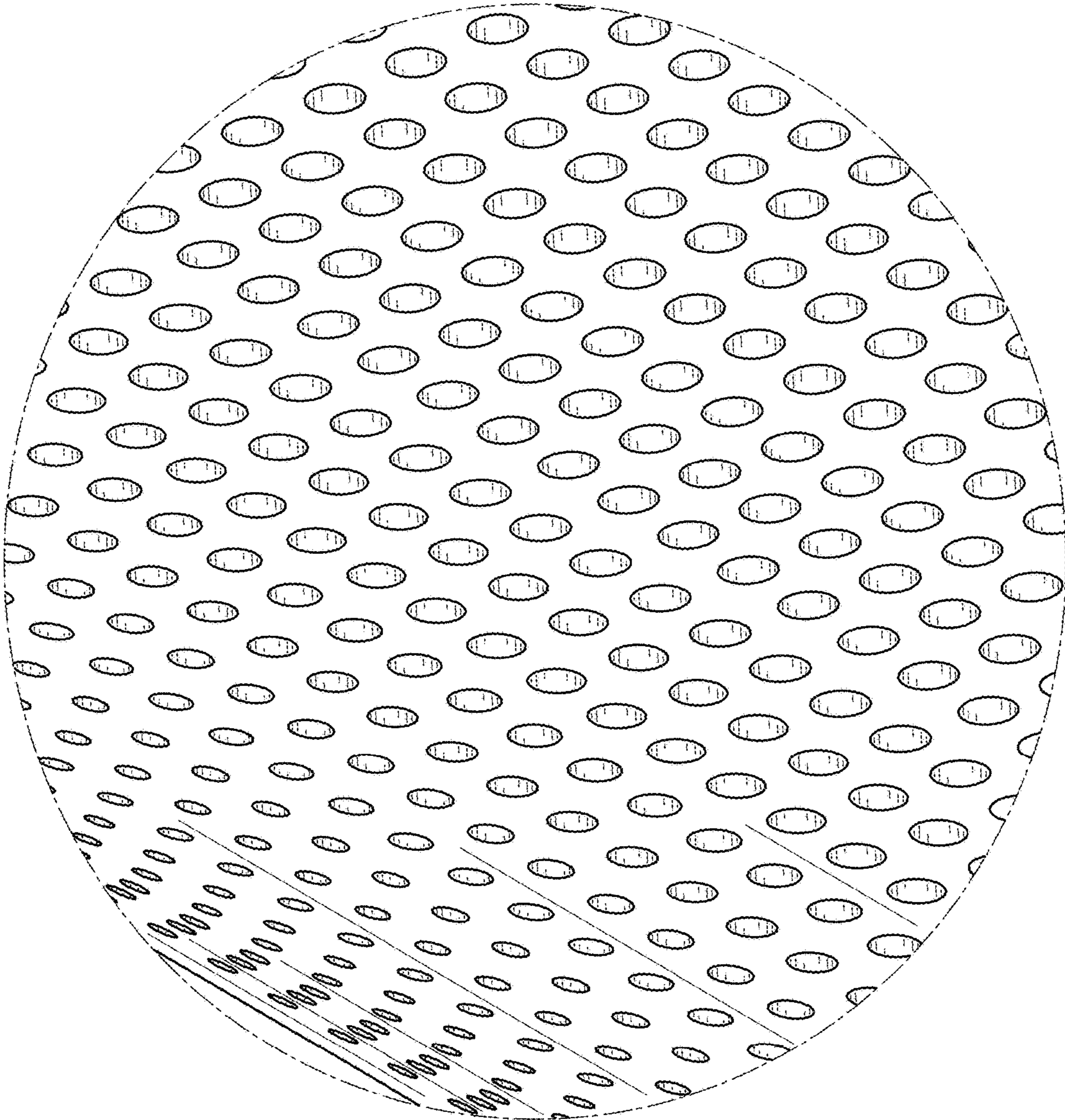

FIG. 22