



US00D819603S

(12) **United States Design Patent**  
**Pearce**

(10) **Patent No.:** **US D819,603 S**  
(45) **Date of Patent:** **\*\* Jun. 5, 2018**

- (54) **ELECTRONIC DEVICE ROTATION ATTACHMENT**
- (71) Applicant: **Creative Law Enforcement Resources, Inc.**, South Pasadena, CA (US)
- (72) Inventor: **Timothy Pearce**, South Pasadena, CA (US)
- (73) Assignee: **Creative Law Enforcement Resources, Inc.**, South Pasadena, CA (US)
- (\*\*) Term: **15 Years**
- (21) Appl. No.: **29/594,091**
- (22) Filed: **Feb. 15, 2017**
- (51) **LOC (11) Cl.** ..... **14-03**
- (52) **U.S. Cl.**  
USPC ..... **D14/217**
- (58) **Field of Classification Search**  
USPC ..... D14/217, 224, 229, 251, 250, 252, 253, D14/299, 432  
CPC ... G06F 1/163; G06K 9/18; A45F 5/00; A45F 3/00; A45F 3/14  
See application file for complete search history.

8,479,990 B2 7/2013 Chiarini  
 8,550,317 B2 10/2013 Hyseni  
 D693,818 S 11/2013 Webber  
 8,672,374 B1 3/2014 Webber  
 D716,287 S \* 10/2014 Ambriz ..... D14/253  
 D721,373 S \* 1/2015 Logereau ..... D14/432  
 D733,147 S 6/2015 Stevens et al.  
 D735,695 S \* 8/2015 Murphy ..... A45F 5/00  
 D14/217  
 9,179,565 B2 11/2015 Cho  
 D749,069 S 2/2016 Senoff  
 D749,083 S 2/2016 Senoff  
 D749,559 S 2/2016 Senoff  
 9,300,346 B2 \* 3/2016 Hirsch ..... H04B 1/385  
 9,335,790 B2 5/2016 Stotler  
 9,397,717 B2 7/2016 Curran  
 D765,662 S 9/2016 Kang  
 D778,275 S \* 2/2017 Gabriel ..... D14/250  
 (Continued)

*Primary Examiner* — Ian Simmons  
*Assistant Examiner* — Khawaja Anwar  
 (74) *Attorney, Agent, or Firm* — Smyrski Law group, A P.C.

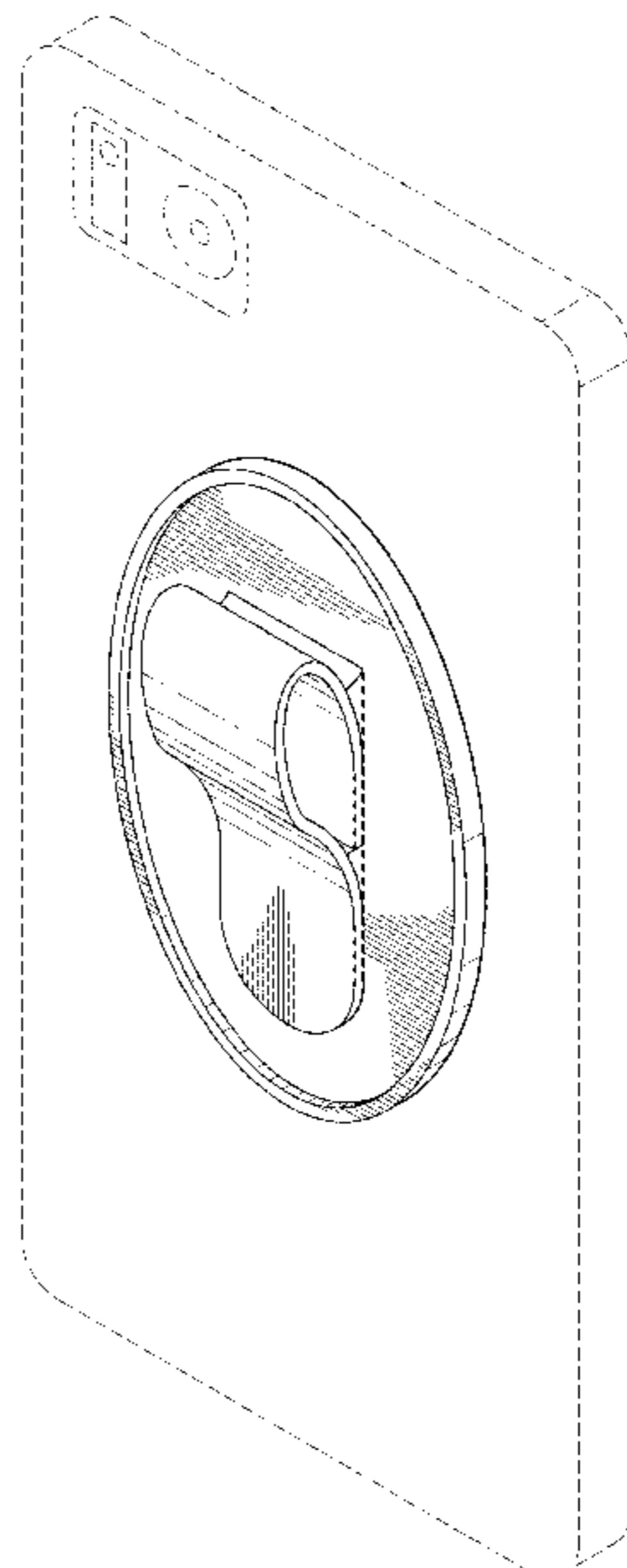
(57) **CLAIM**  
 The ornamental design for an electronic device rotation attachment, as shown and described.

**DESCRIPTION**

FIG. 1 is a perspective view of the electronic device rotation attachment showing my new design;  
 FIG. 2 is a front view thereof;  
 FIG. 3 is a rear view thereof;  
 FIG. 4 is a right side elevation view thereof;  
 FIG. 5 is a left side elevation view thereof;  
 FIG. 6 is a top view thereof; and,  
 FIG. 7 is a bottom view thereof.  
 The broken lines shown in FIG. 1 represent unclaimed environment and form no part of the claimed design.

**1 Claim, 3 Drawing Sheets**

- (56) **References Cited**  
 U.S. PATENT DOCUMENTS  
 3,866,873 A 2/1975 Bohli  
 4,202,139 A 5/1980 Hong et al.  
 5,647,624 A 7/1997 Beshara, Jr.  
 5,680,977 A 10/1997 Burke  
 6,550,108 B2 4/2003 Pratl  
 6,869,053 B2 3/2005 Adams, IV  
 D590,386 S 4/2009 Leith et al.  
 7,661,567 B2 2/2010 Myers  
 D613,291 S \* 4/2010 Carver ..... D14/218  
 D613,292 S \* 4/2010 Carver ..... D14/218  
 7,770,728 B2 8/2010 Karen



(56)

**References Cited**

U.S. PATENT DOCUMENTS

D780,739 S \* 3/2017 Kalbach ..... D14/250  
D781,832 S \* 3/2017 Snitko ..... D14/250  
D788,092 S \* 5/2017 Phang ..... D14/250  
9,788,640 B2 \* 10/2017 Kroupa ..... A45F 5/004  
2007/0181620 A1 8/2007 Carver, III  
2009/0090750 A1 \* 4/2009 Alcenat ..... A45F 5/00  
224/101  
2009/0270050 A1 \* 10/2009 Brown ..... A45F 5/00  
455/90.3  
2010/0222118 A1 \* 9/2010 Interdanato ..... H04B 1/385  
455/575.6  
2011/0266316 A1 11/2011 Ghalib et al.  
2011/0284599 A1 11/2011 Sternick  
2013/0119099 A1 5/2013 Interdonato  
2013/0146625 A1 6/2013 Karle et al.  
2013/0277992 A1 10/2013 Senoff  
2015/0122852 A1 5/2015 Feng

\* cited by examiner

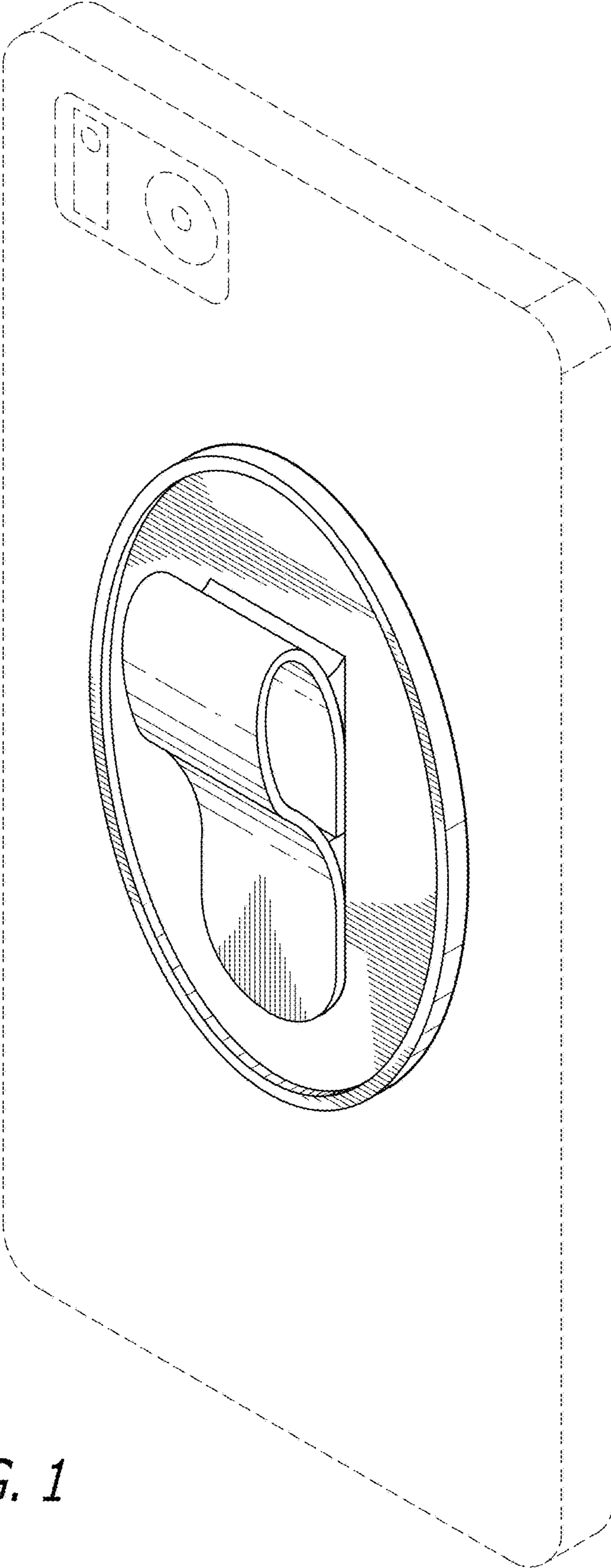
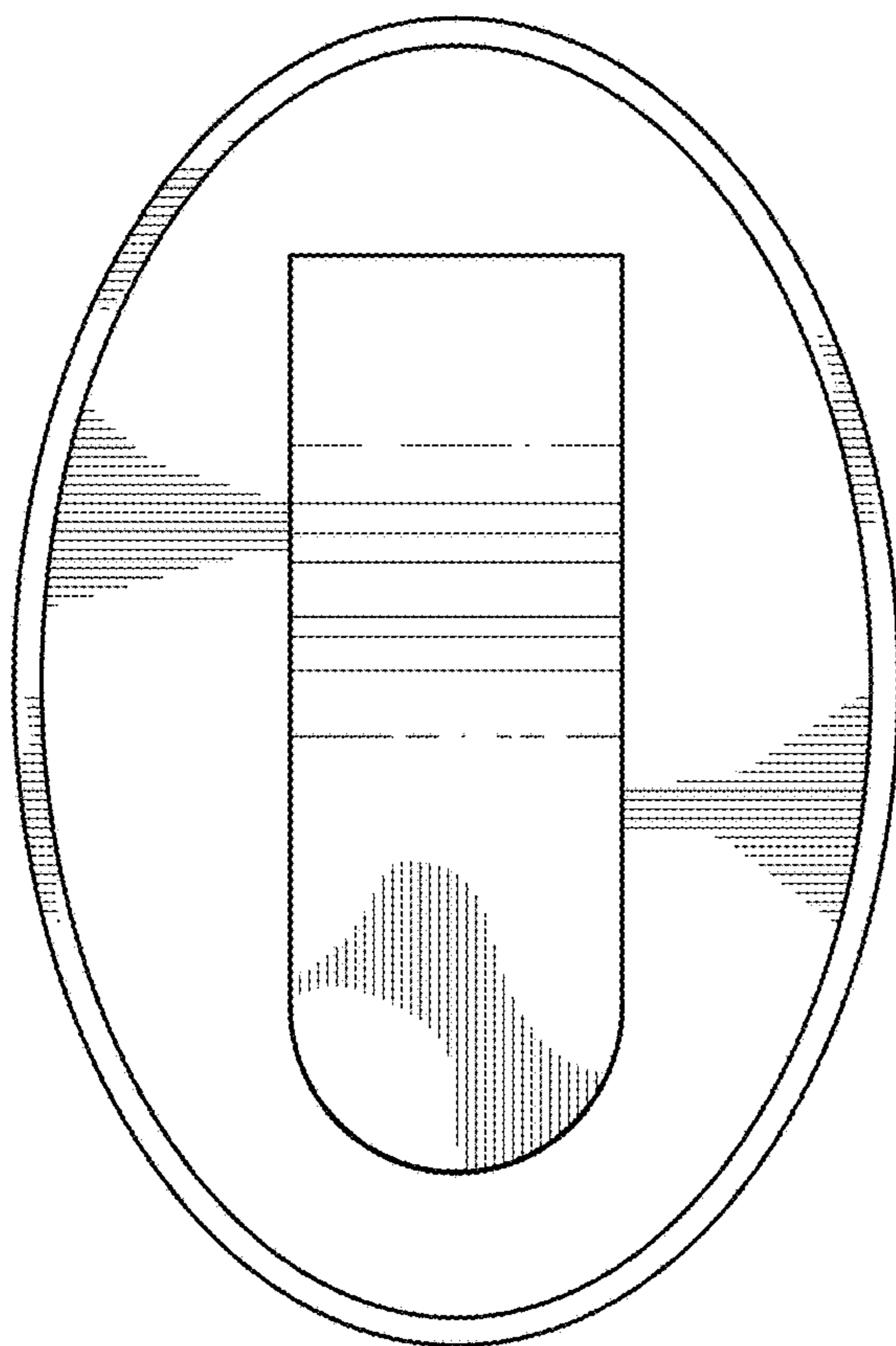
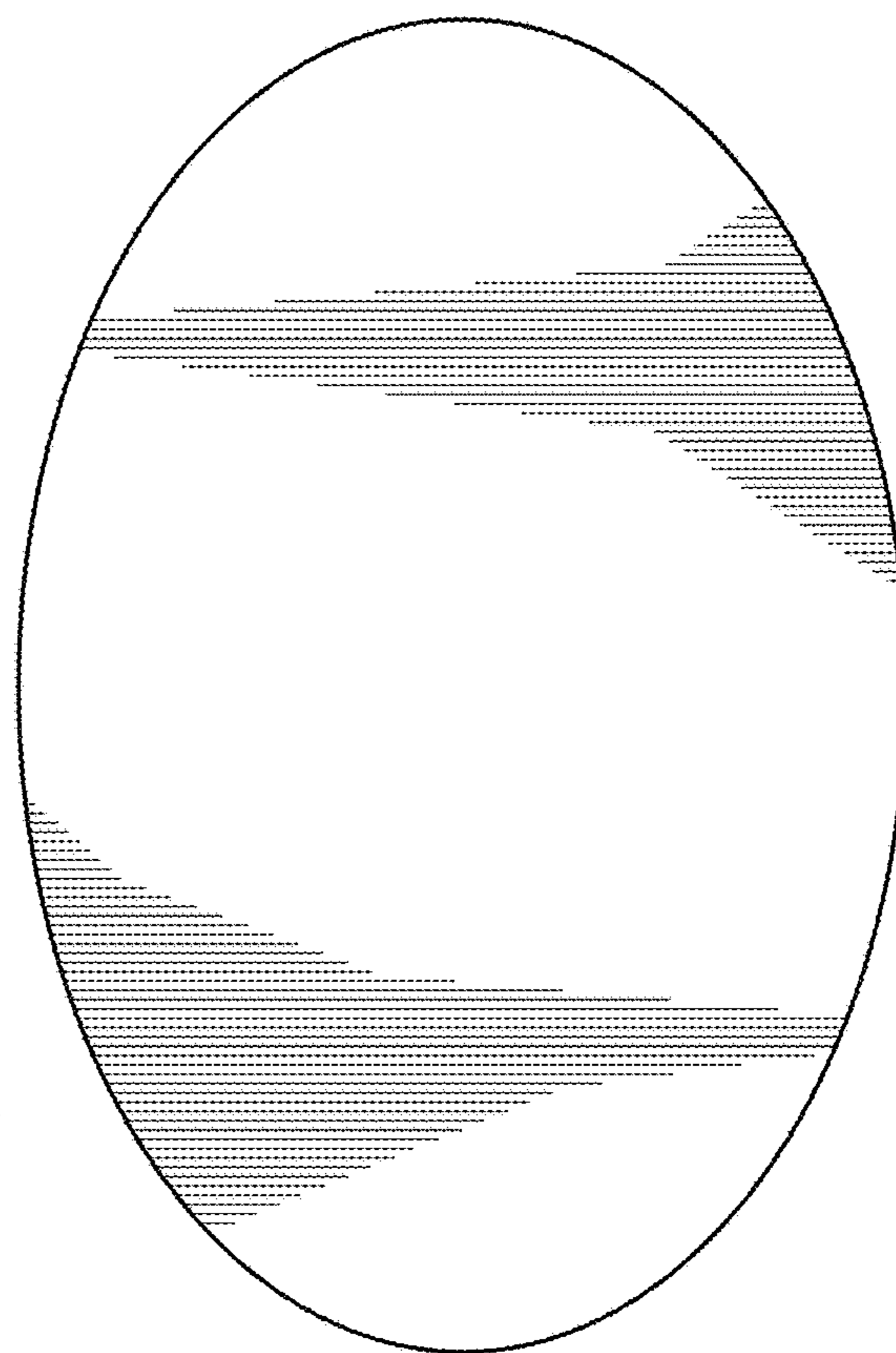


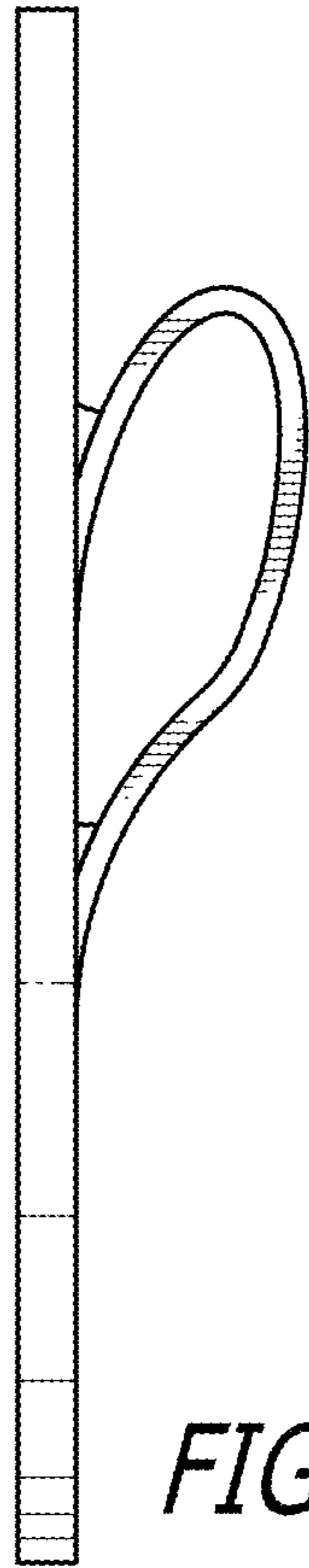
FIG. 1



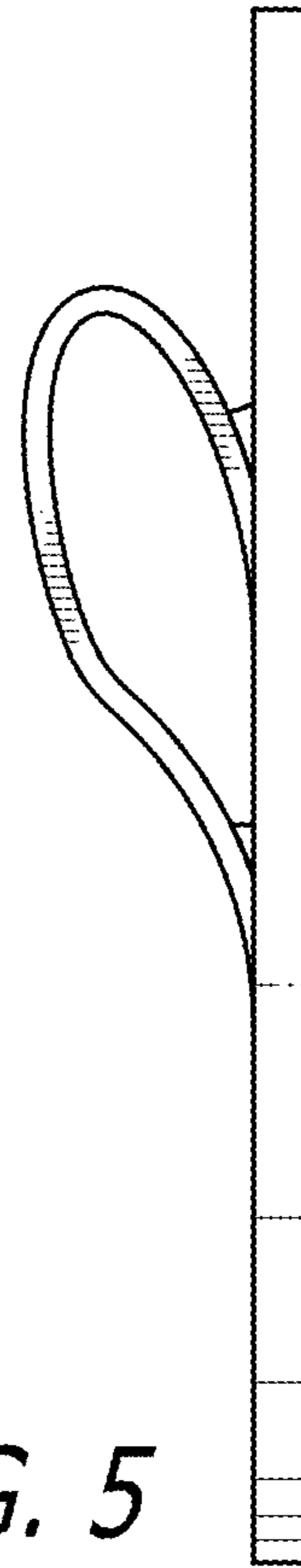
*FIG. 2*



*FIG. 3*

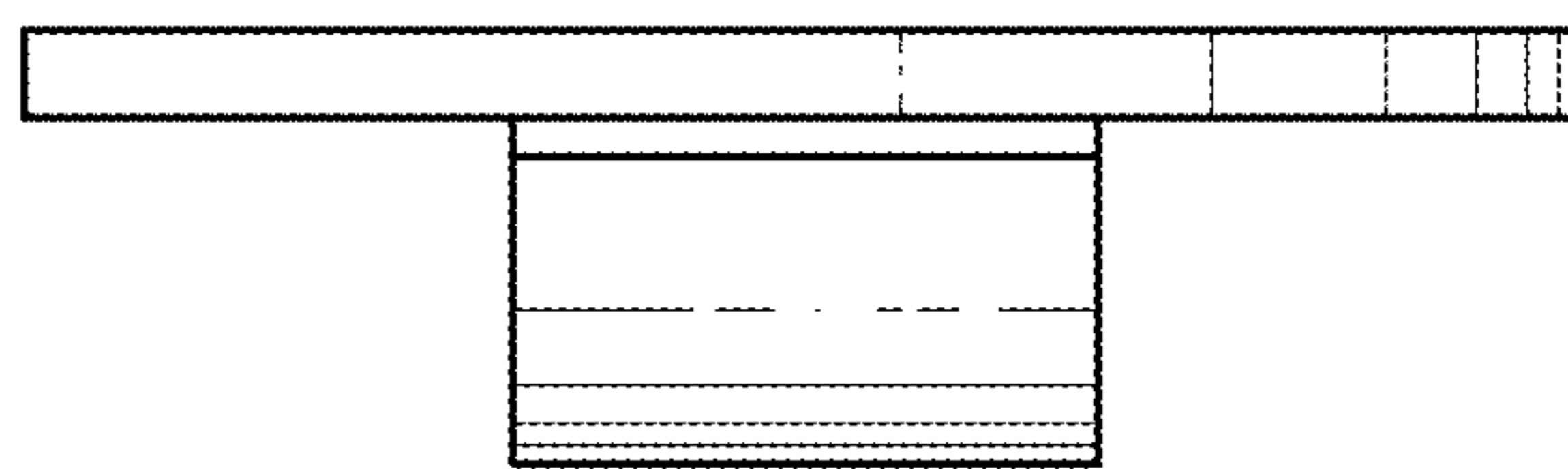


*FIG. 4*



*FIG. 5*

*FIG. 6*



*FIG. 7*

