



US00D819586S

(12) **United States Design Patent**  
**Ryu et al.**

(10) **Patent No.:** **US D819,586 S**  
(45) **Date of Patent:** **\*\* \*Jun. 5, 2018**

- (54) **TV RECEIVER**
- (71) Applicant: **LG ELECTRONICS INC.**, Seoul (KR)
- (72) Inventors: **Junghan Ryu**, Seoul (KR); **Sehdong Yoo**, Seoul (KR); **Bodeung Hwang**, Seoul (KR); **Yuonui Chong**, Seoul (KR); **Yongseok Kim**, Seoul (KR); **Seonkyu Kim**, Seoul (KR)
- (73) Assignee: **LG ELECTRONICS INC.**, Seoul (KR)

- D733,082 S \* 6/2015 Hwangbo ..... D14/126
- D768,100 S \* 10/2016 Seo ..... D14/126
- D772,830 S \* 11/2016 Kim ..... D14/126
- D773,419 S \* 12/2016 Han ..... D14/126
- D774,483 S \* 12/2016 Kim ..... D14/126
- D774,484 S \* 12/2016 Han ..... D14/126

(Continued)

*Primary Examiner* — Michael A. Pratt  
(74) *Attorney, Agent, or Firm* — Birch, Stewart, Kolasch & Birch, LLP

(\*) Notice: This patent is subject to a terminal disclaimer.

(\*\*) Term: **15 Years**

(21) Appl. No.: **35/501,863**

(22) Filed: **May 11, 2016**

(80) **Hague Agreement Data**

Int. Filing Date: **May 11, 2016**  
Int. Reg. No.: **DM/091909**  
Int. Reg. Date: **May 11, 2016**  
Int. Reg. Pub. Date: **Nov. 11, 2016**

(30) **Foreign Application Priority Data**

Nov. 13, 2015 (KR) ..... 30-2015-0057373

(51) **LOC (11) Cl.** ..... **02-01**

(52) **U.S. Cl.**  
USPC ..... **D14/126**

(58) **Field of Classification Search**  
USPC ..... D14/126, 127, 128, 336, 448  
CPC ... G06F 1/1601; G06F 1/1643; H05K 5/0004;  
H05K 5/0017; H05K 5/02; H05K 5/0217  
See application file for complete search history.

(56) **References Cited**

**U.S. PATENT DOCUMENTS**

- D661,268 S \* 6/2012 Itou ..... D14/126
- D692,403 S \* 10/2013 Takami ..... D14/126

(57) **CLAIM**

The ornamental design for a TV receiver, as shown and described.

**DESCRIPTION**

- 1. TV receiver
- 1.1 : Perspective
- 1.2 : Rear perspective view
- 1.3 : Front
- 1.4 : Back
- 1.5 : Left
- 1.6 : Right
- 1.7 : Top
- 1.8 : Bottom
- 1.9 : Perspective
- 1.10 : Rear perspective view
- 1.11 : Front
- 1.12 : Back
- 1.13 : Left
- 1.14 : Right
- 1.15 : Top
- 1.16 : Bottom
- 1.17 : Reference

The broken lines shown in FIGS. 1.2, 1.4, 1.5, 1.8, 1.10, 1.12, 1.13 and 1.16 indicate portions of the TV receiver that do not form a part of the claimed design. The broken lines shown in FIG. 1.17 are for the purpose of illustrating environment and form no part of the claimed design.

**1 Claim, 17 Drawing Sheets**

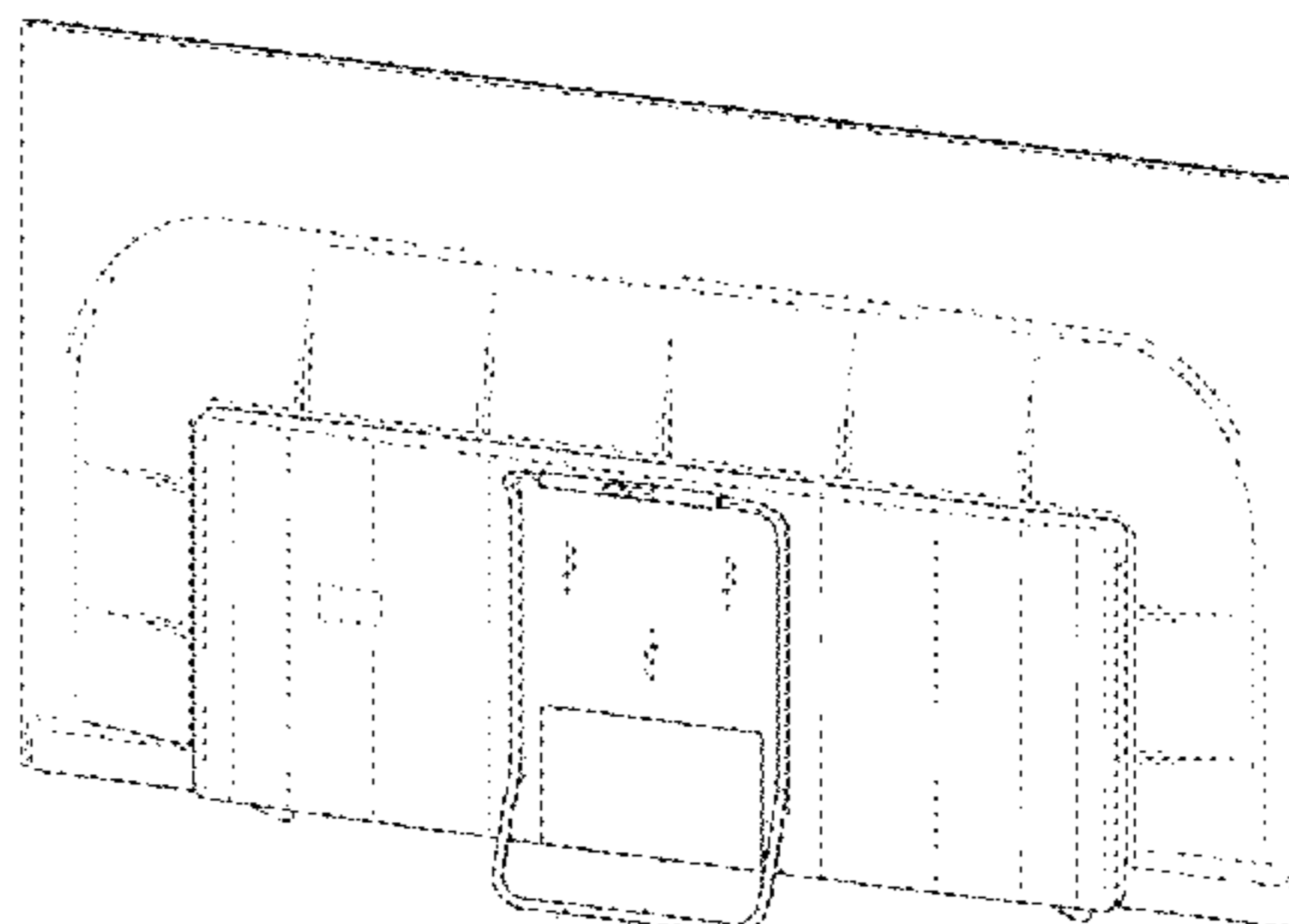
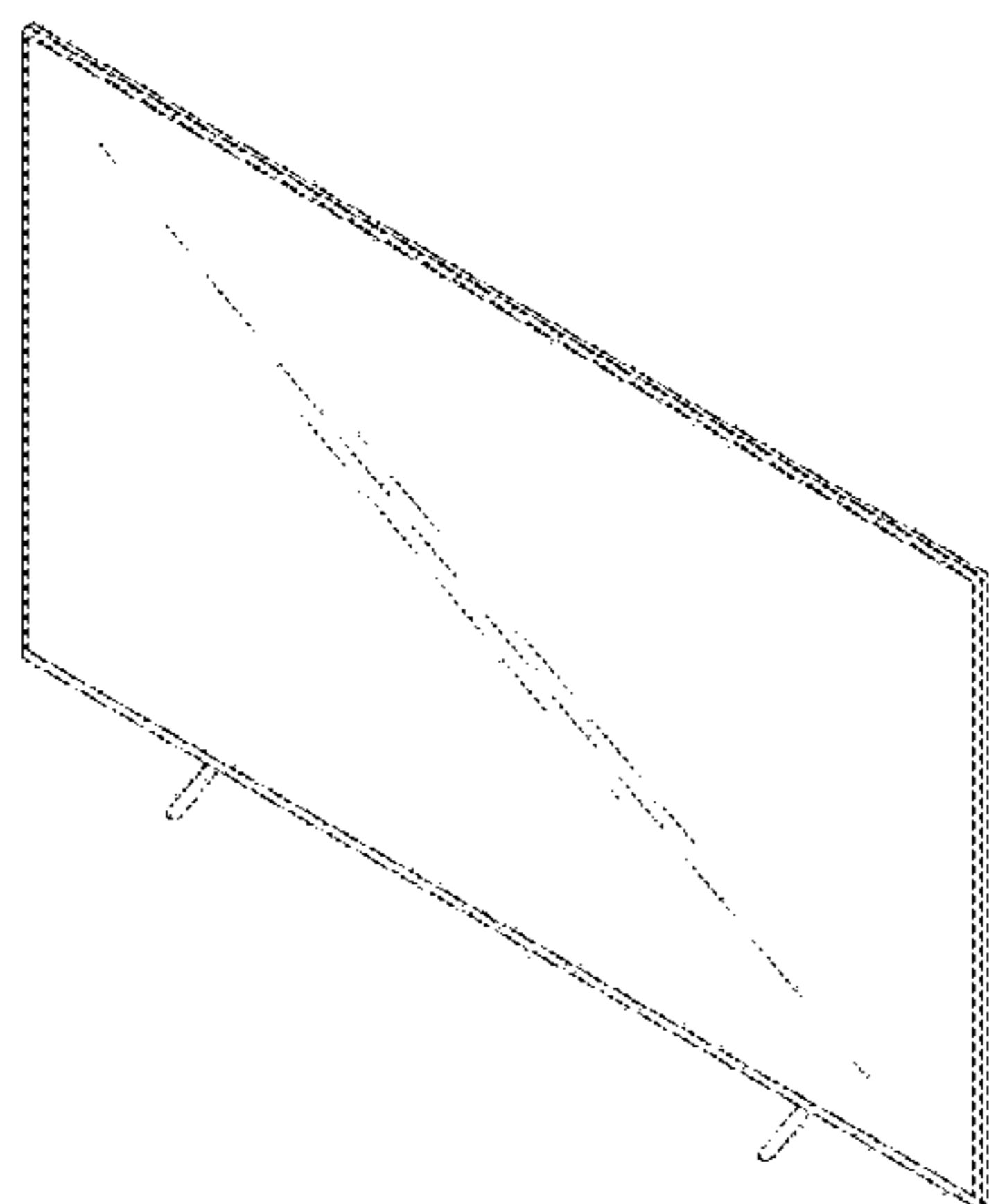

(56)

**References Cited**

U.S. PATENT DOCUMENTS

D775,094 S	*	12/2016	Kim	.....	D14/126
D778,854 S	*	2/2017	Lee	.....	D14/126
D778,855 S	*	2/2017	Lee	.....	D14/126
D780,140 S	*	2/2017	Kim	.....	D14/126

\* cited by examiner

1.1

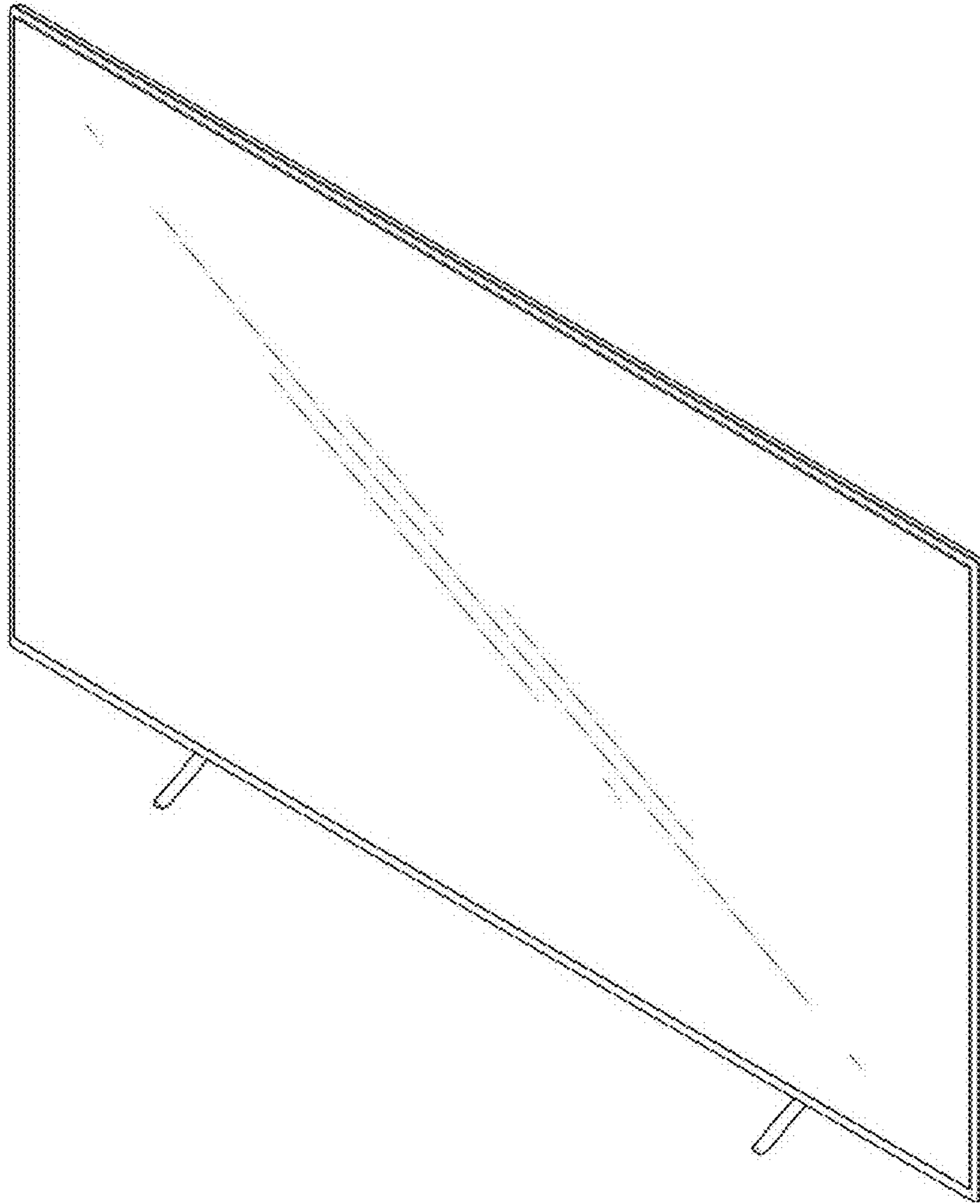

1.2

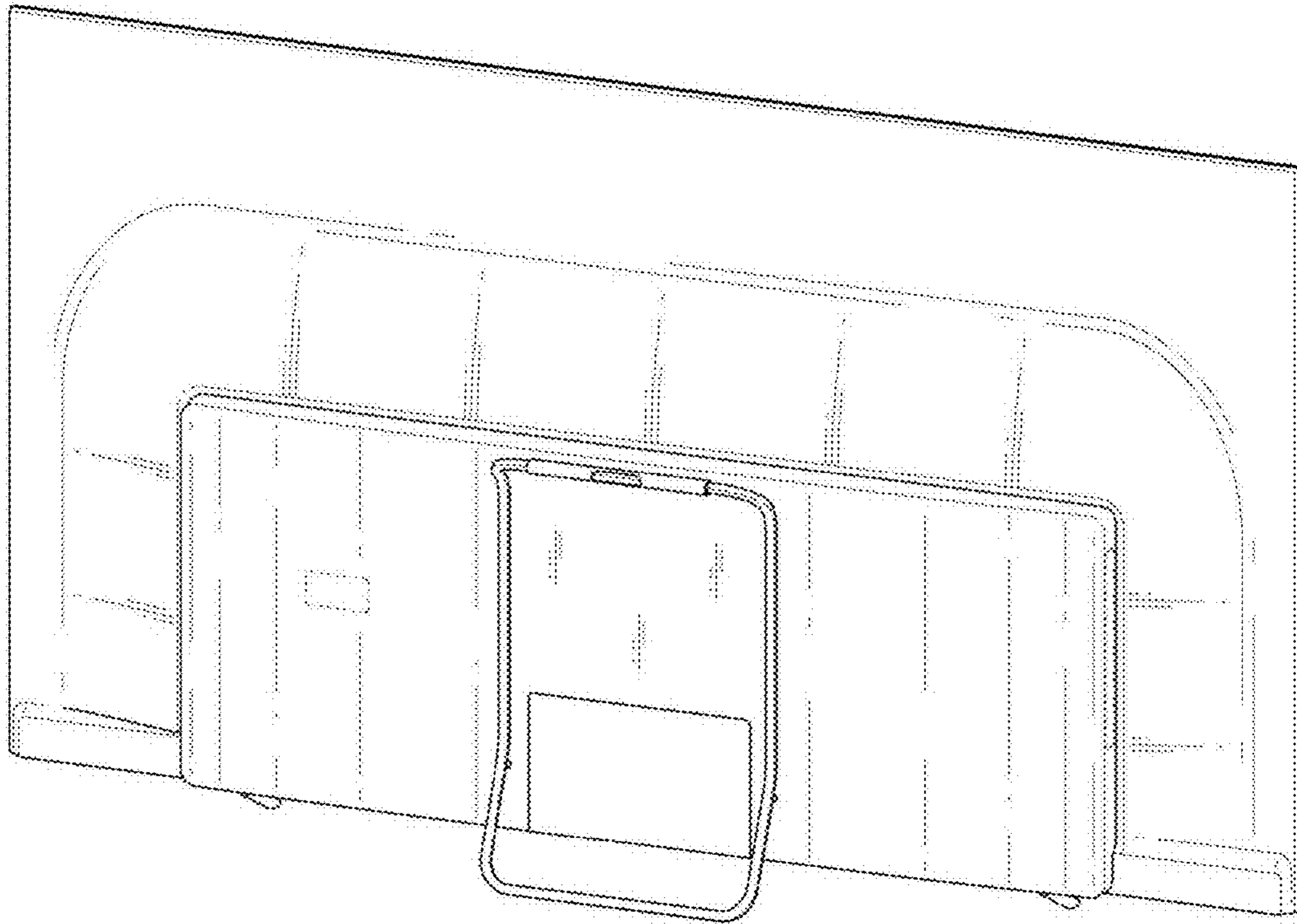

1.3

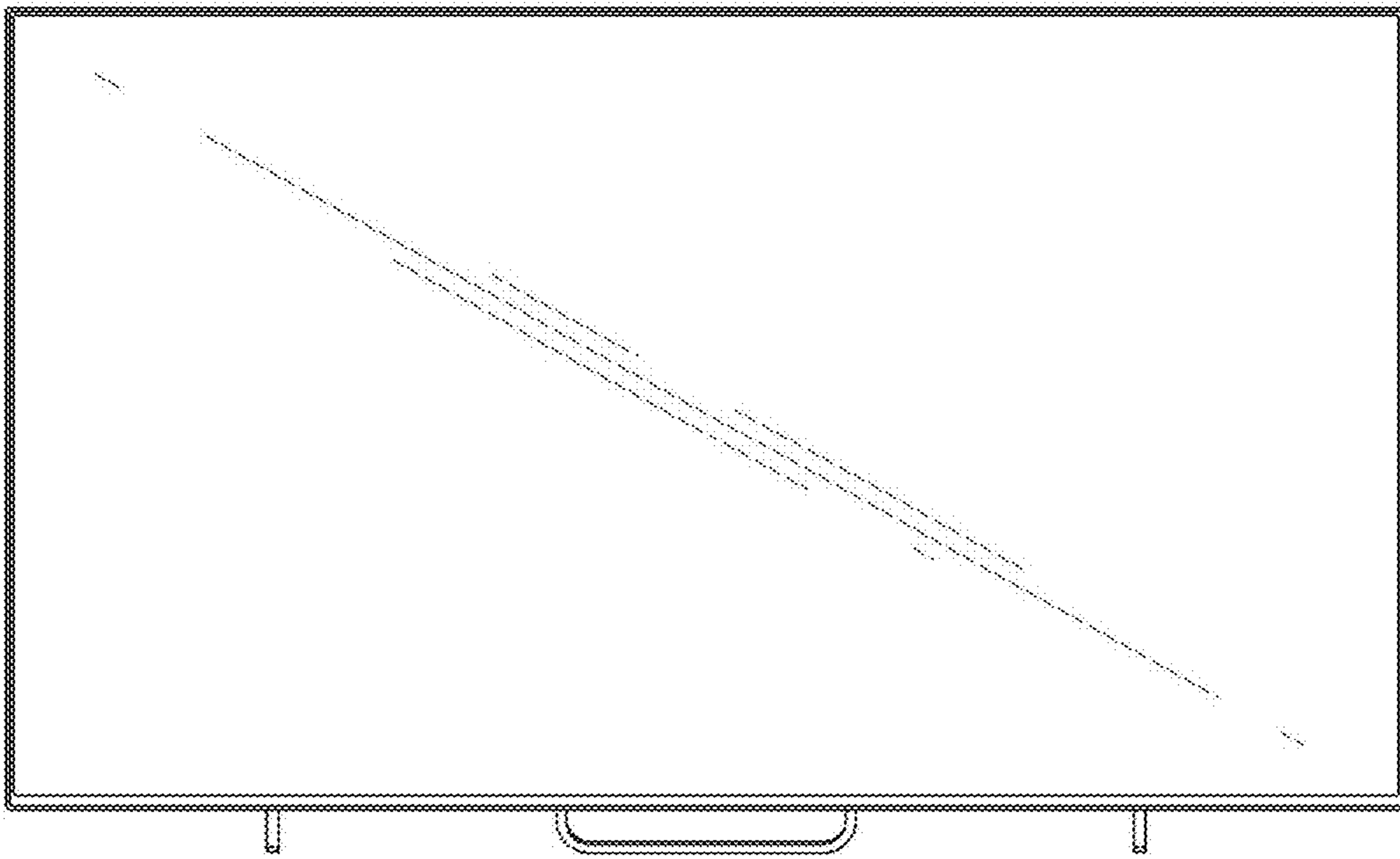

1.4

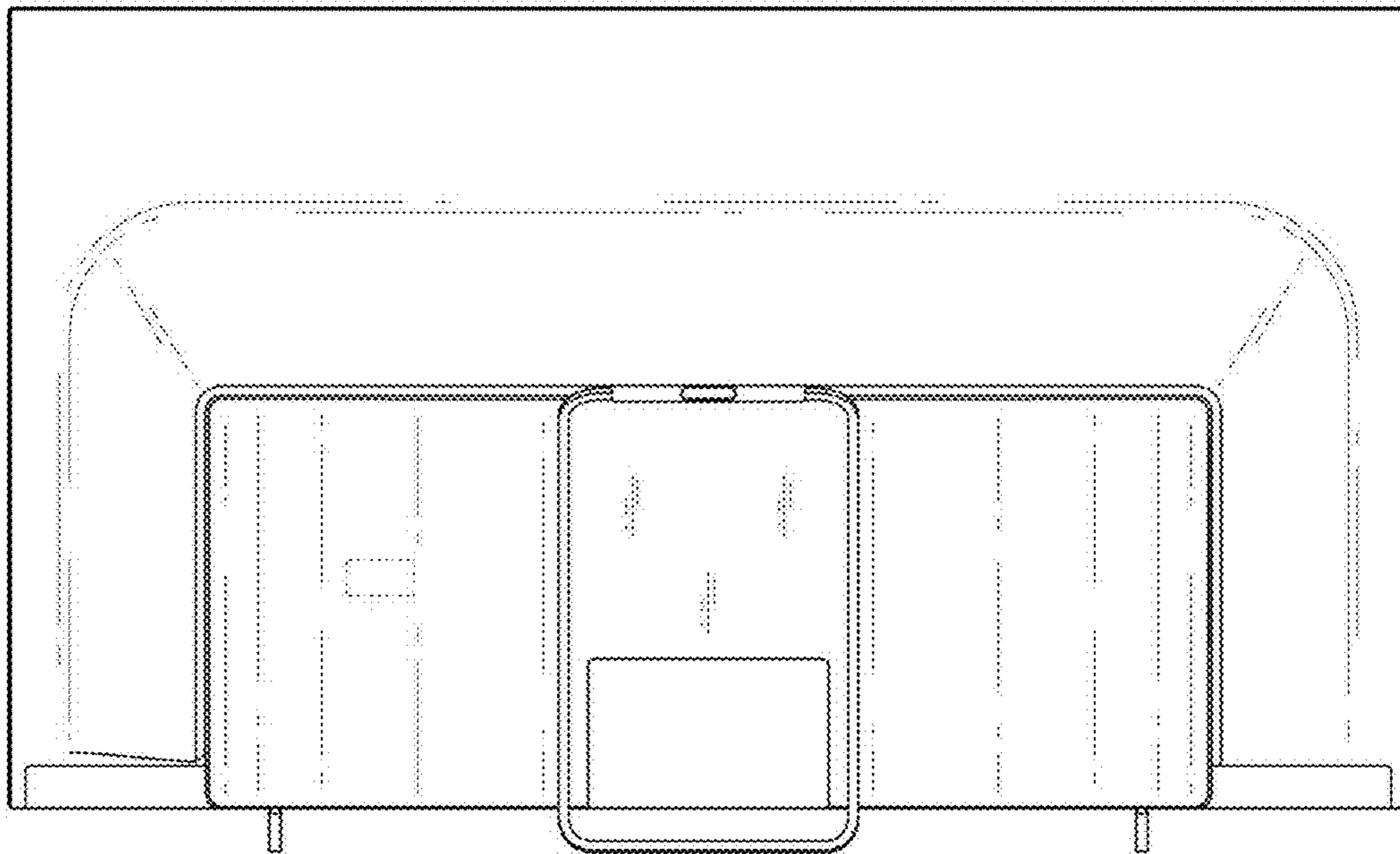



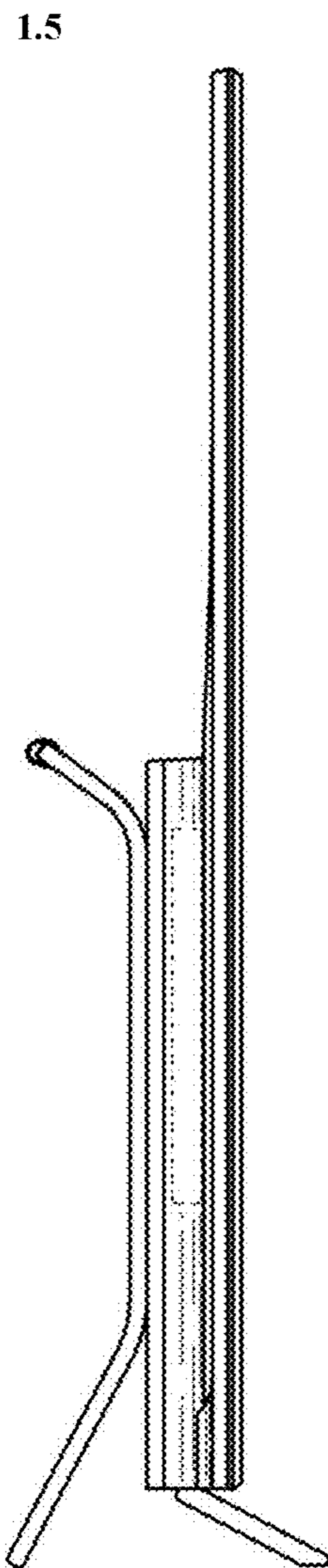

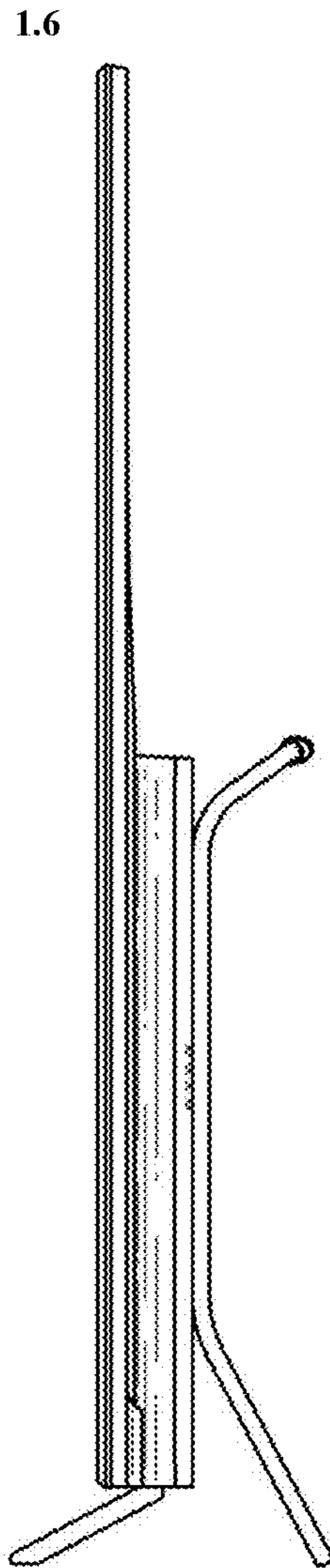



1.7

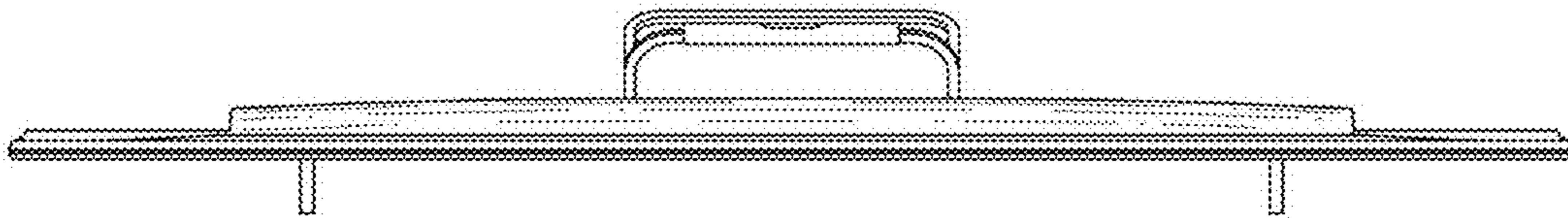

1.8

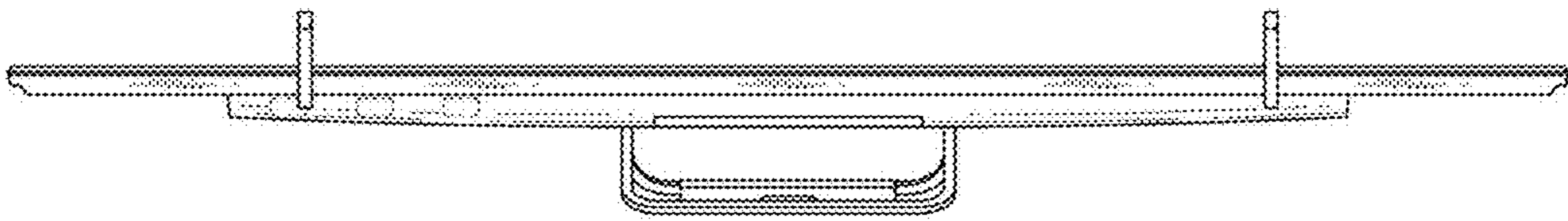

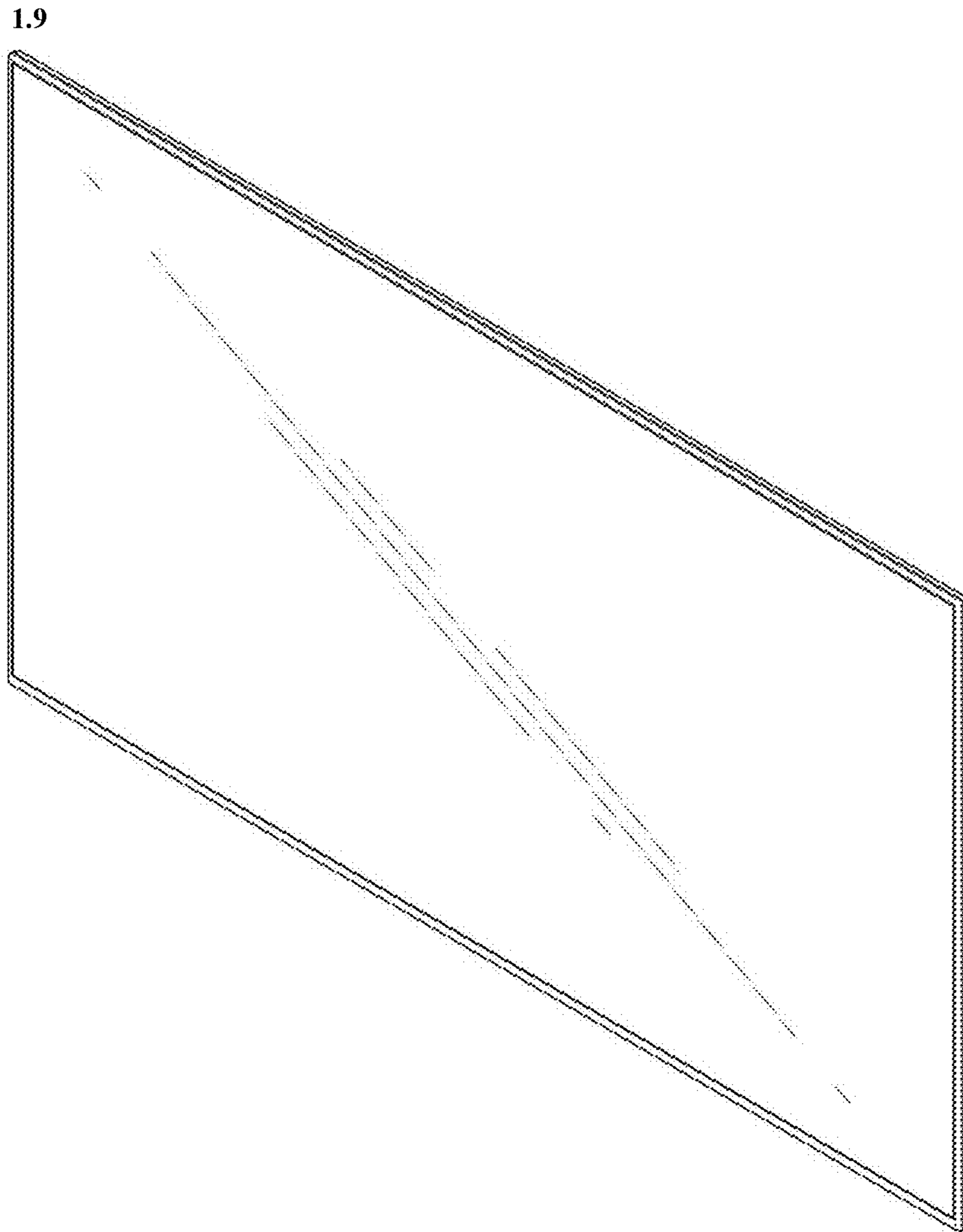

1.10

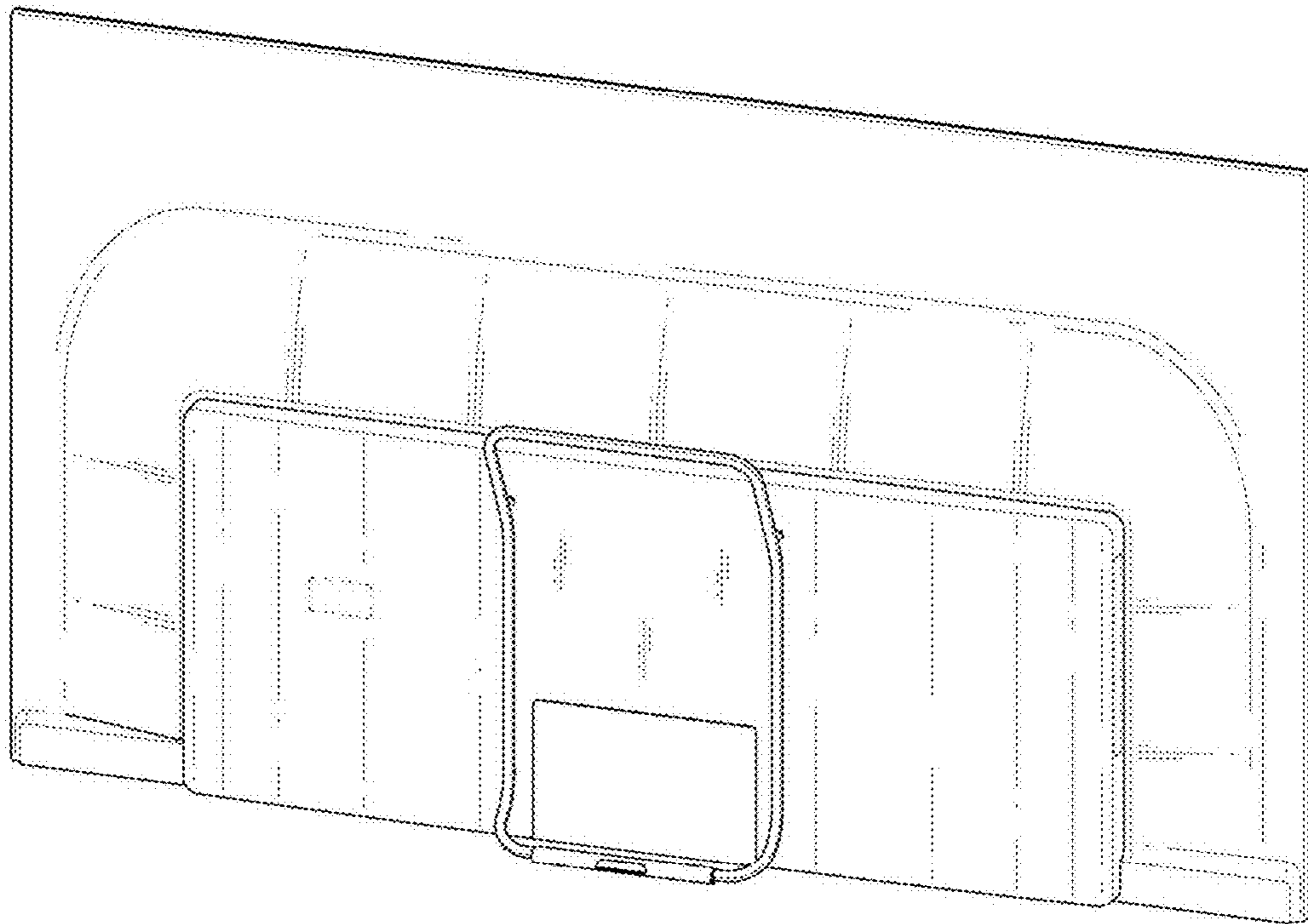

1.11

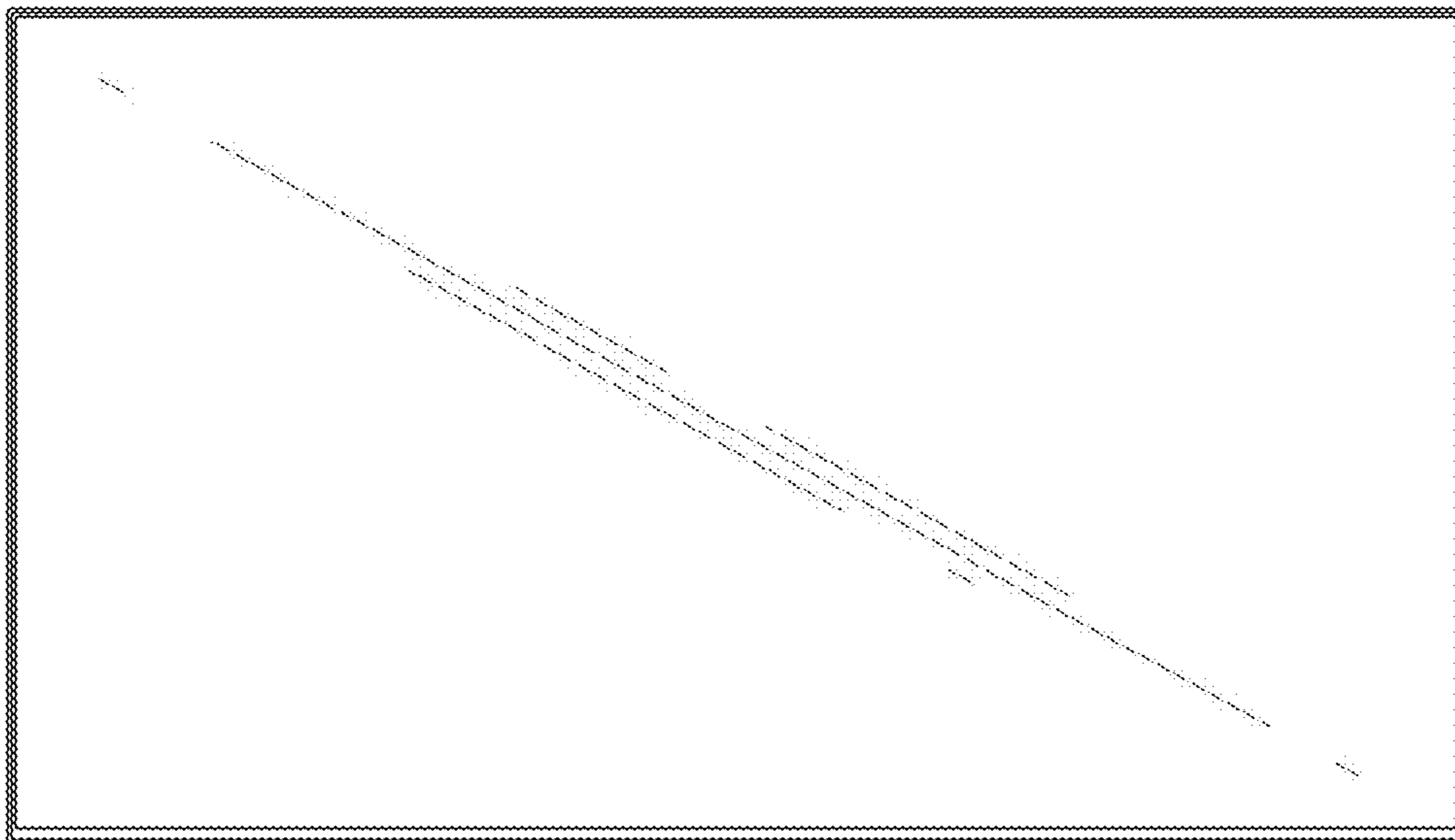

1.12

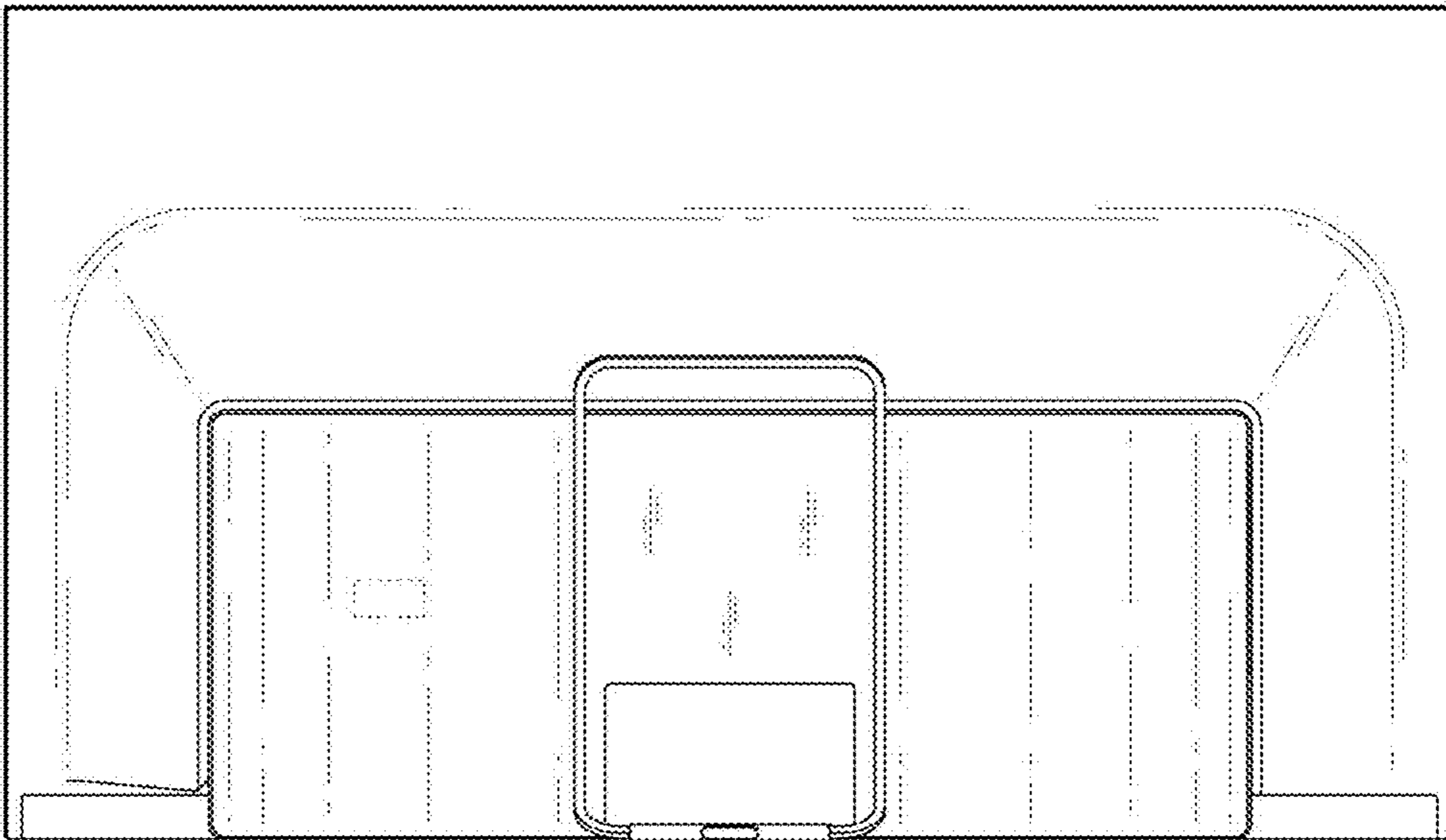

1.13

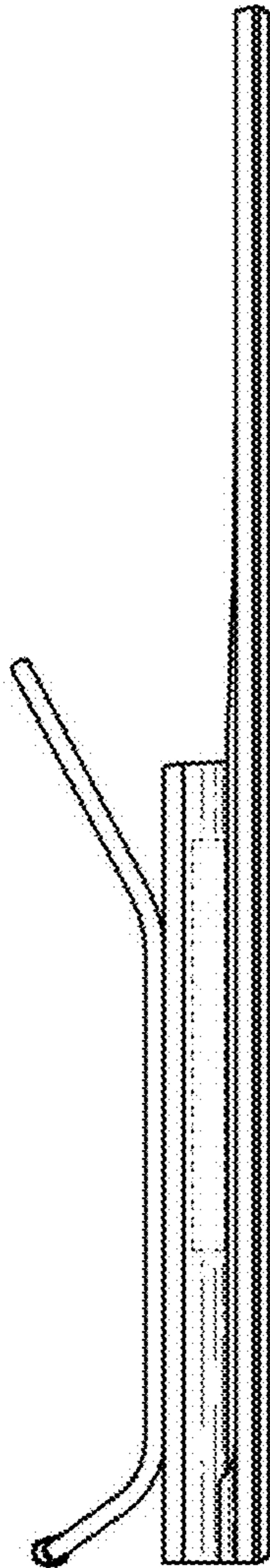



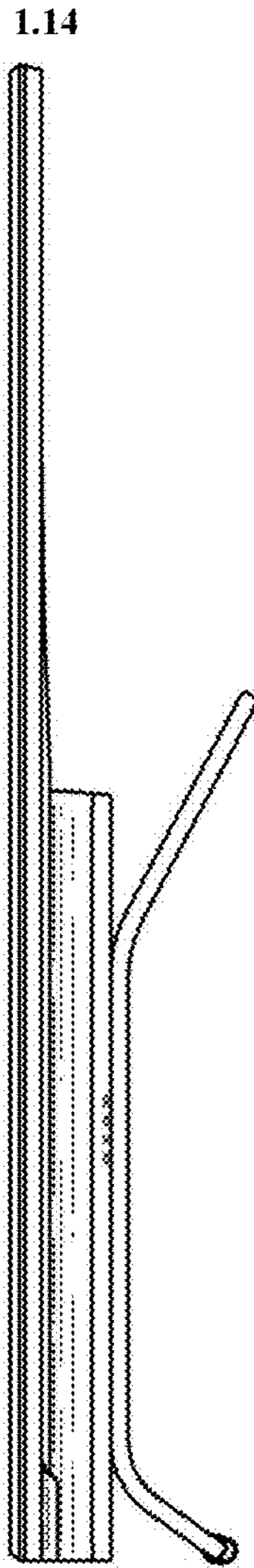

1.15

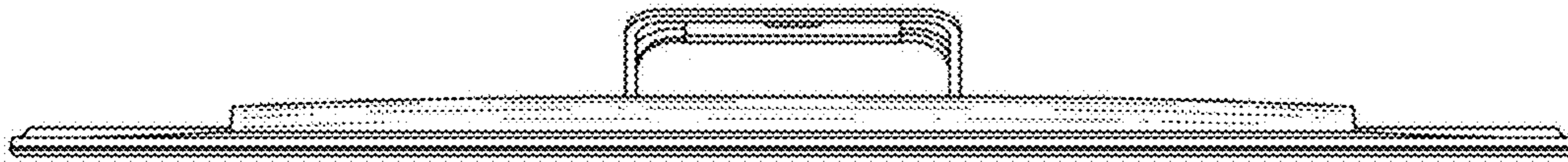

1.16



1.17

