



US00D819579S

(12) **United States Design Patent**
Huang

(10) **Patent No.:** **US D819,579 S**
(45) **Date of Patent:** **** Jun. 5, 2018**

(54) **HEAT SINK**
(71) Applicant: **Tsung-Hsien Huang**, I-Lan Hsien (TW)
(72) Inventor: **Tsung-Hsien Huang**, I-Lan Hsien (TW)
(**) Term: **15 Years**
(21) Appl. No.: **29/575,419**
(22) Filed: **Aug. 24, 2016**

(30) **Foreign Application Priority Data**

Jul. 22, 2016 (CN) 2016 3 0339279

(51) **LOC (11) Cl.** **13-03**
(52) **U.S. Cl.**
USPC **D13/179**
(58) **Field of Classification Search**
USPC D13/179, 145, 184
CPC . F28D 15/0275; F28D 21/0003; F02M 26/32;
F28F 1/025; F28F 3/022; F28F 21/00
See application file for complete search history.

(56) **References Cited**

U.S. PATENT DOCUMENTS

D487,885 S * 3/2004 Fan D13/179
D496,338 S * 9/2004 Chen D13/179
D573,110 S * 7/2008 Otsuki D13/179
D579,423 S * 10/2008 Chang D13/179
D582,359 S * 12/2008 Chang D13/179
D715,750 S * 10/2014 Mira D13/179
D786,807 S * 5/2017 Murphy D13/179
2009/0016023 A1* 1/2009 Cao F28D 15/0233
361/702
2009/0050305 A1* 2/2009 He F28D 15/0233
165/182
2009/0260782 A1* 10/2009 Whitney B21D 53/02
165/104.21
2010/0126700 A1* 5/2010 Chen F28D 15/0233
165/104.26

2012/0067550 A1* 3/2012 Shih F28D 15/0233
165/104.21
2013/0168055 A1* 7/2013 Wu F28D 15/0233
165/104.26
2014/0202666 A1* 7/2014 Cheng F28F 3/06
165/104.26
2015/0219400 A1* 8/2015 Sasaki H01L 23/427
165/104.26
2017/0094843 A1* 3/2017 Agostini F28F 13/10
2017/0102186 A1* 4/2017 Huang F28D 15/0275
2017/0153063 A1* 6/2017 Lin F28D 15/0233
2017/0153065 A1* 6/2017 Lan F28D 15/0275
2017/0229376 A1* 8/2017 Lin H01L 23/427

* cited by examiner

Primary Examiner — Jennifer Rivard
Assistant Examiner — April Rivas
(74) *Attorney, Agent, or Firm* — Pai Patent & Trademark
Law Firm; Chao-Chang David Pai

(57) **CLAIM**

The ornamental design for a heat sink, as shown and described.

DESCRIPTION

FIG. 1 is a top perspective view of a heat sink, showing my new design;
FIG. 2 is a bottom perspective view thereof;
FIG. 3 is a front elevational view thereof;
FIG. 4 is a rear elevational view thereof;
FIG. 5 is a left side elevational view thereof;
FIG. 6 is a right side elevational view thereof;
FIG. 7 is a top plan view thereof; and,
FIG. 8 is a bottom plan view thereof.
The broken lines within the hexagram shaped openings in FIG. 7 illustrate portions of the heat sink and form no part of the claimed design.

1 Claim, 5 Drawing Sheets

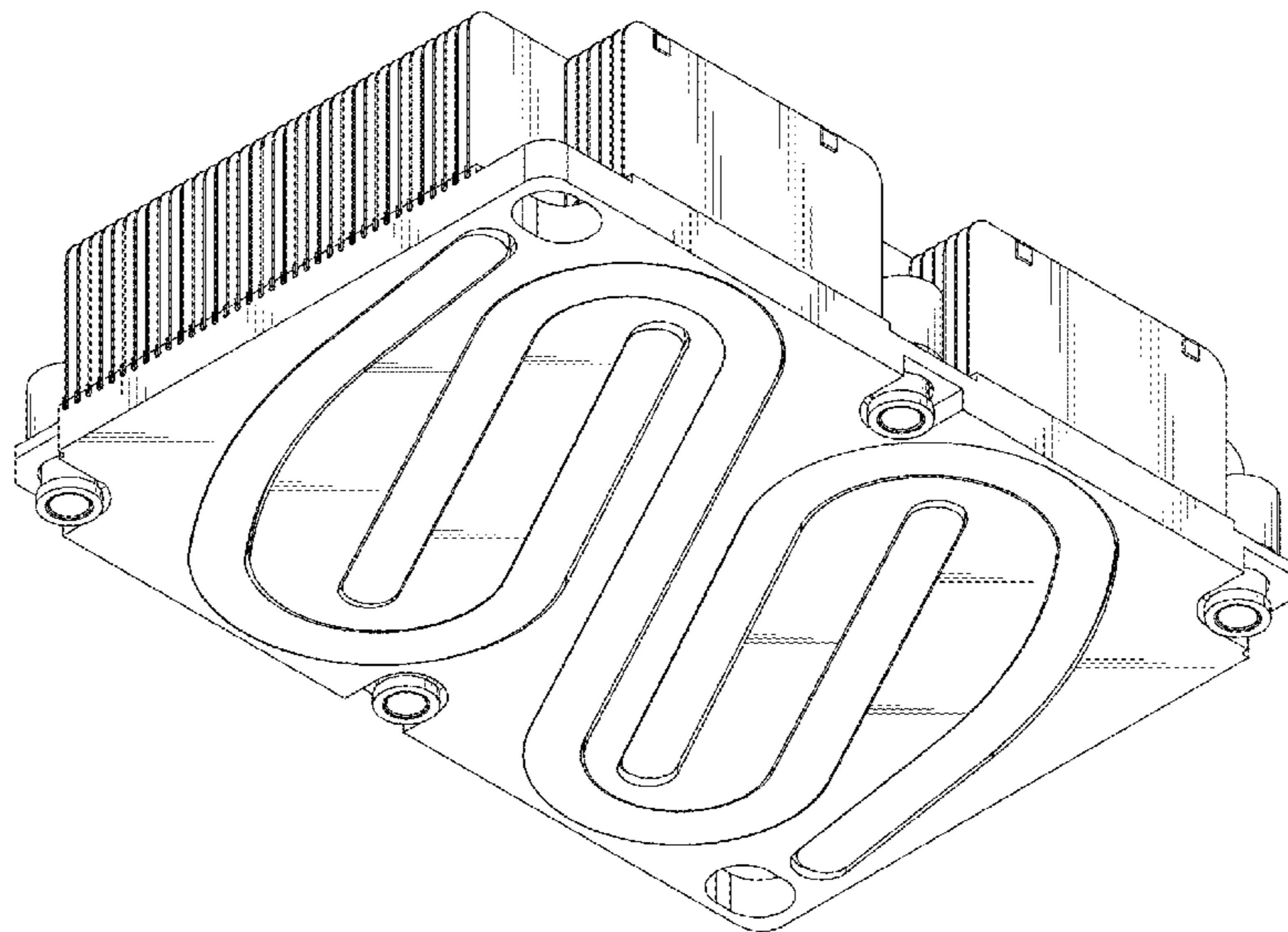

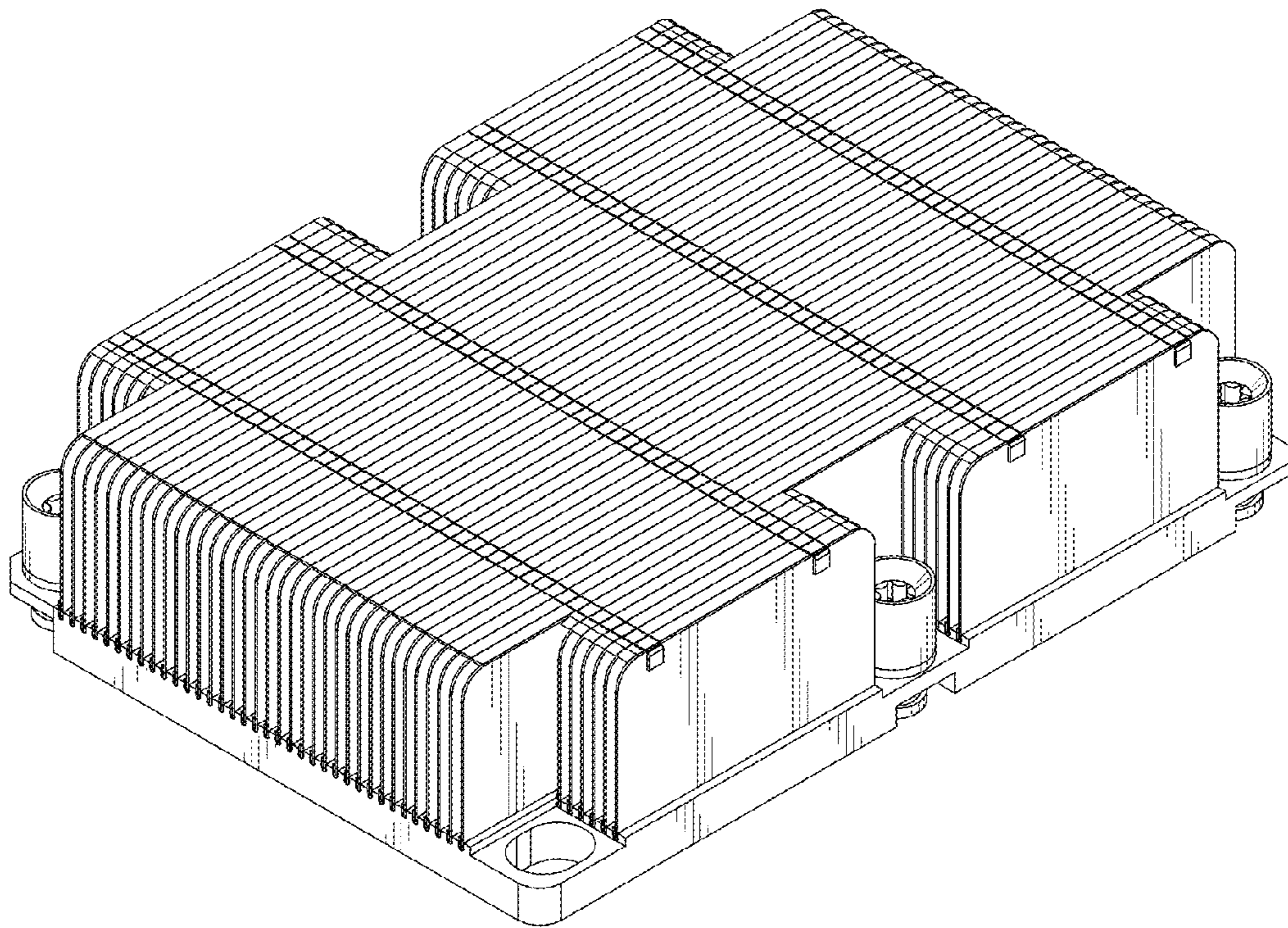

FIG. 1

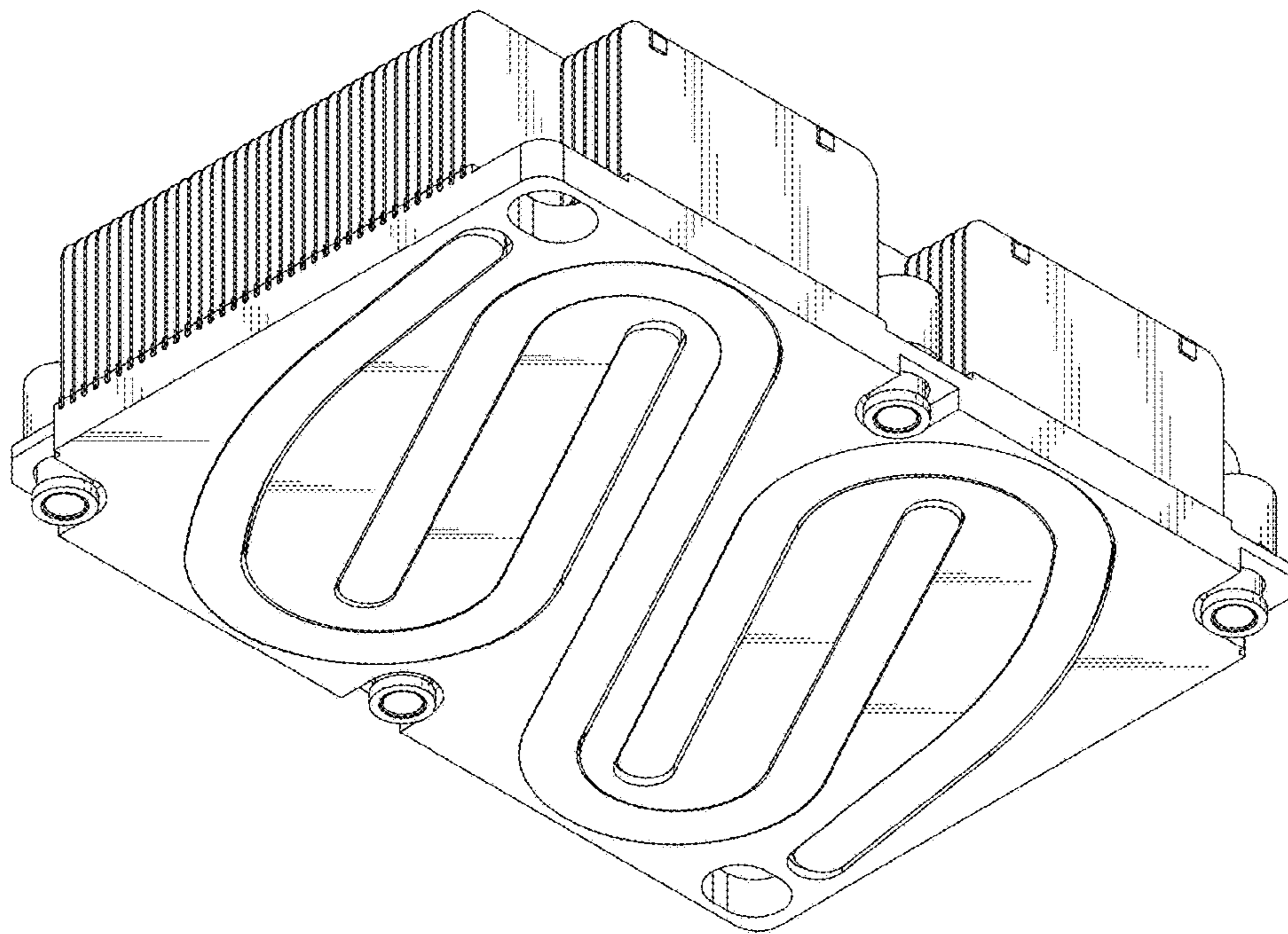

FIG. 2

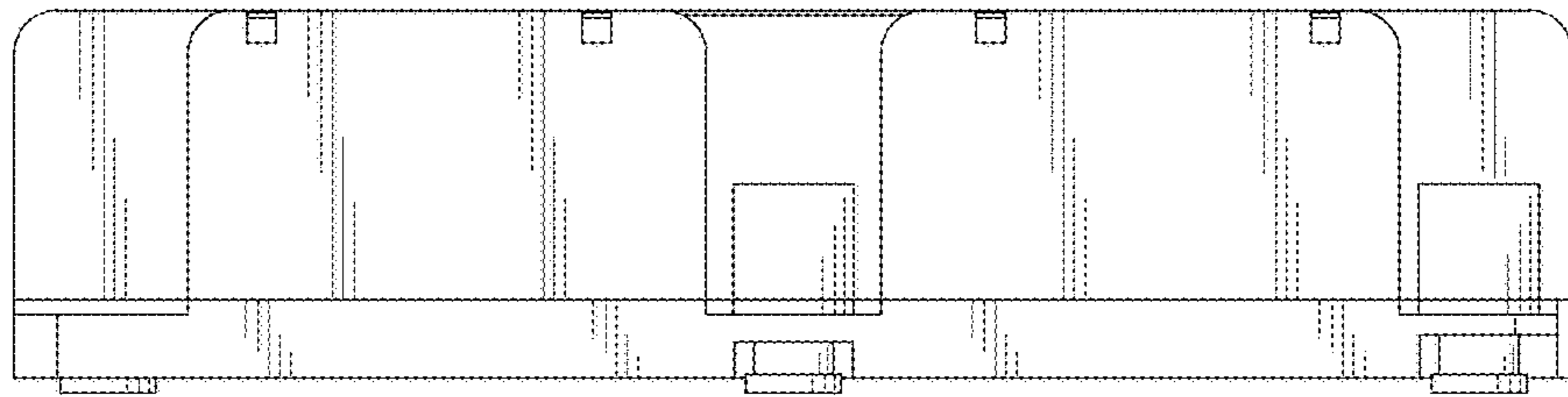

FIG. 3

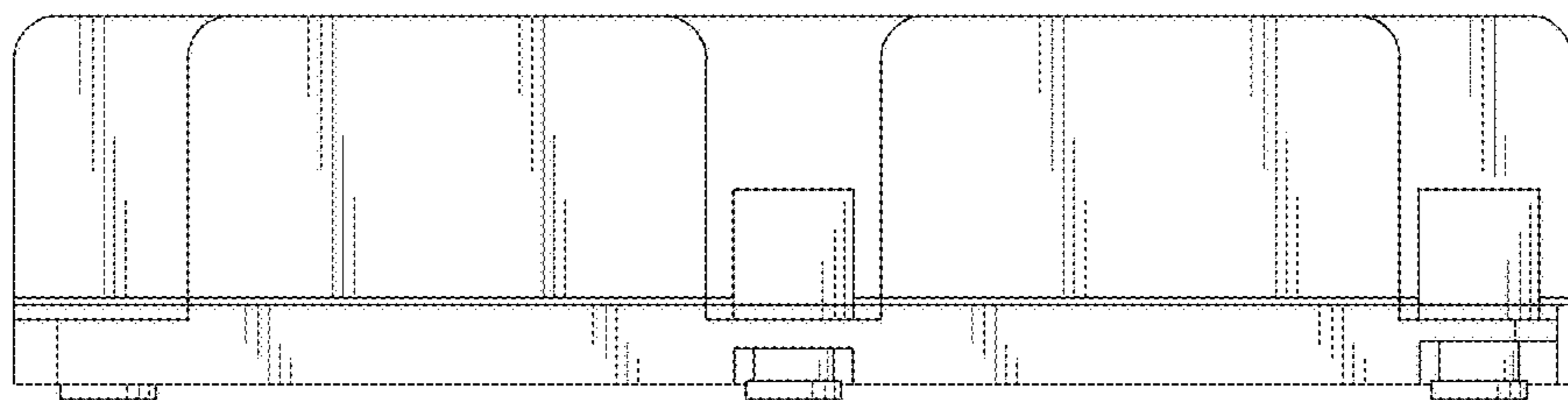

FIG. 4

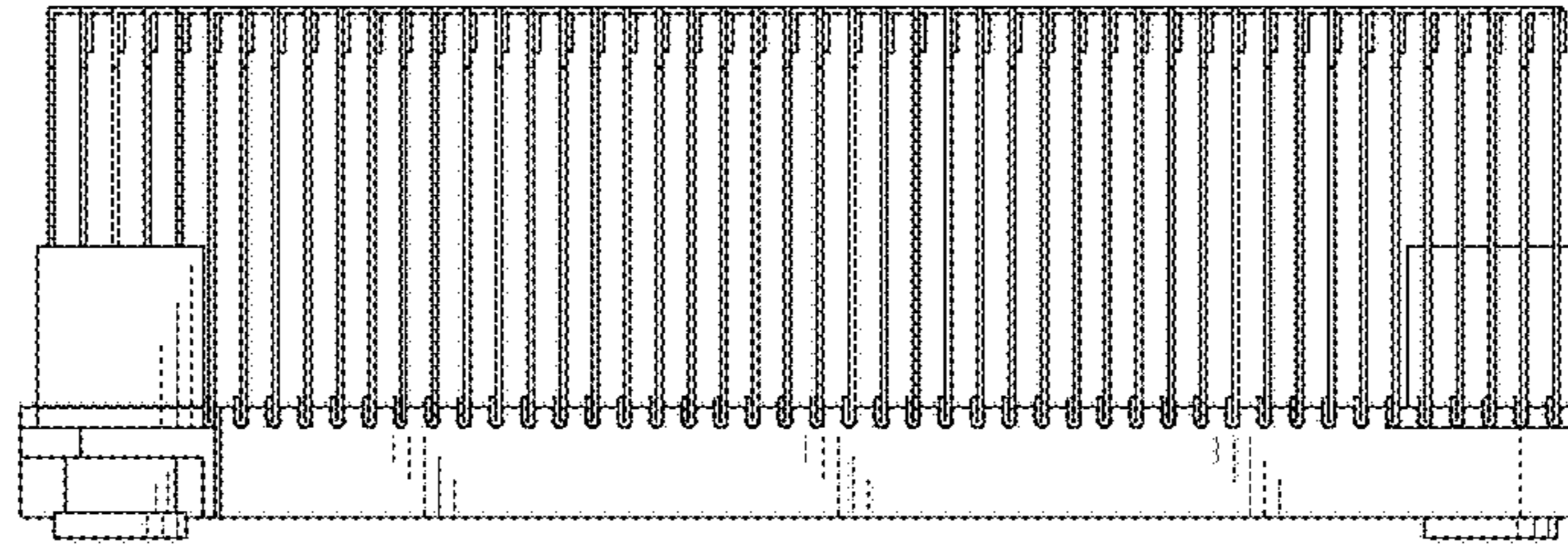

FIG. 5

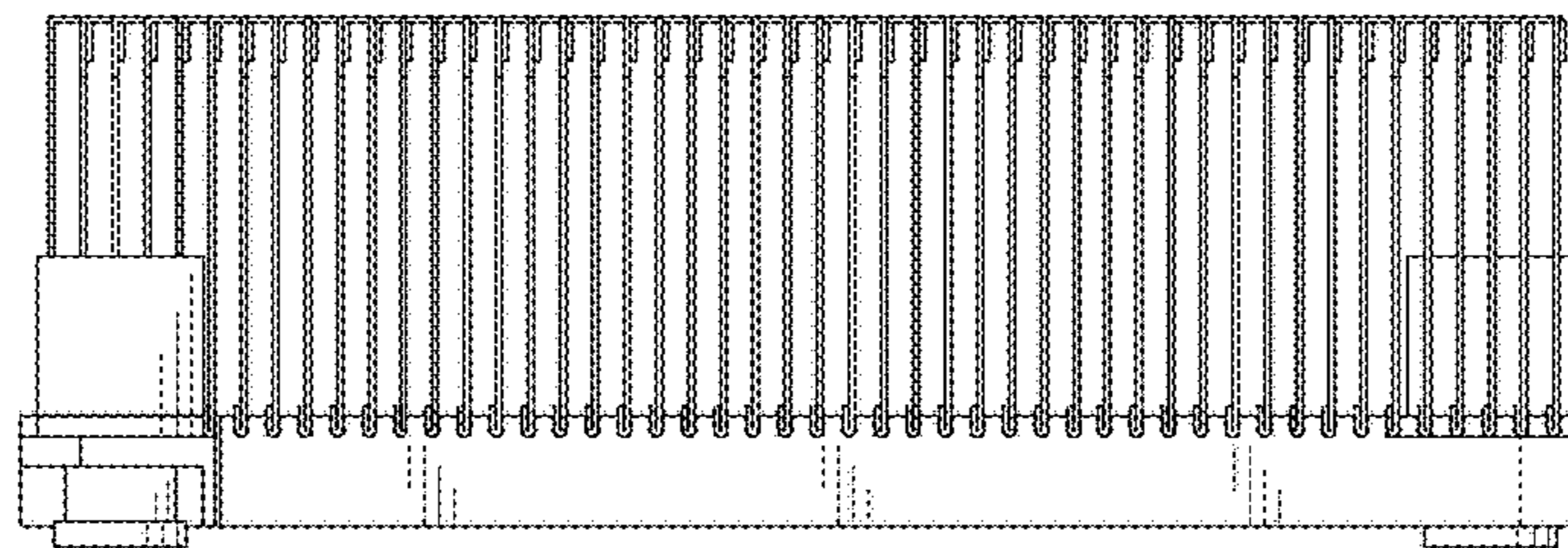

FIG. 6

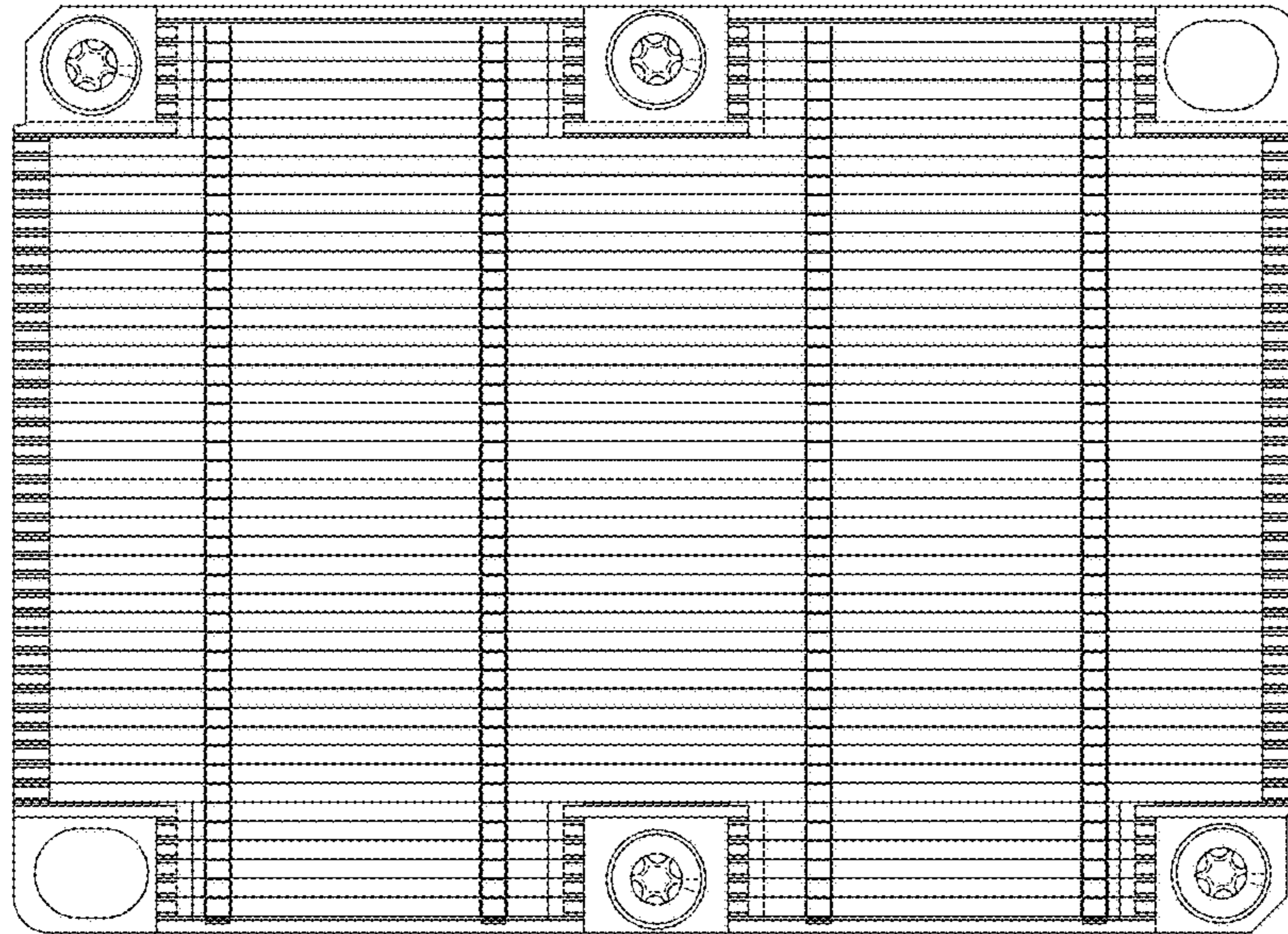

FIG. 7

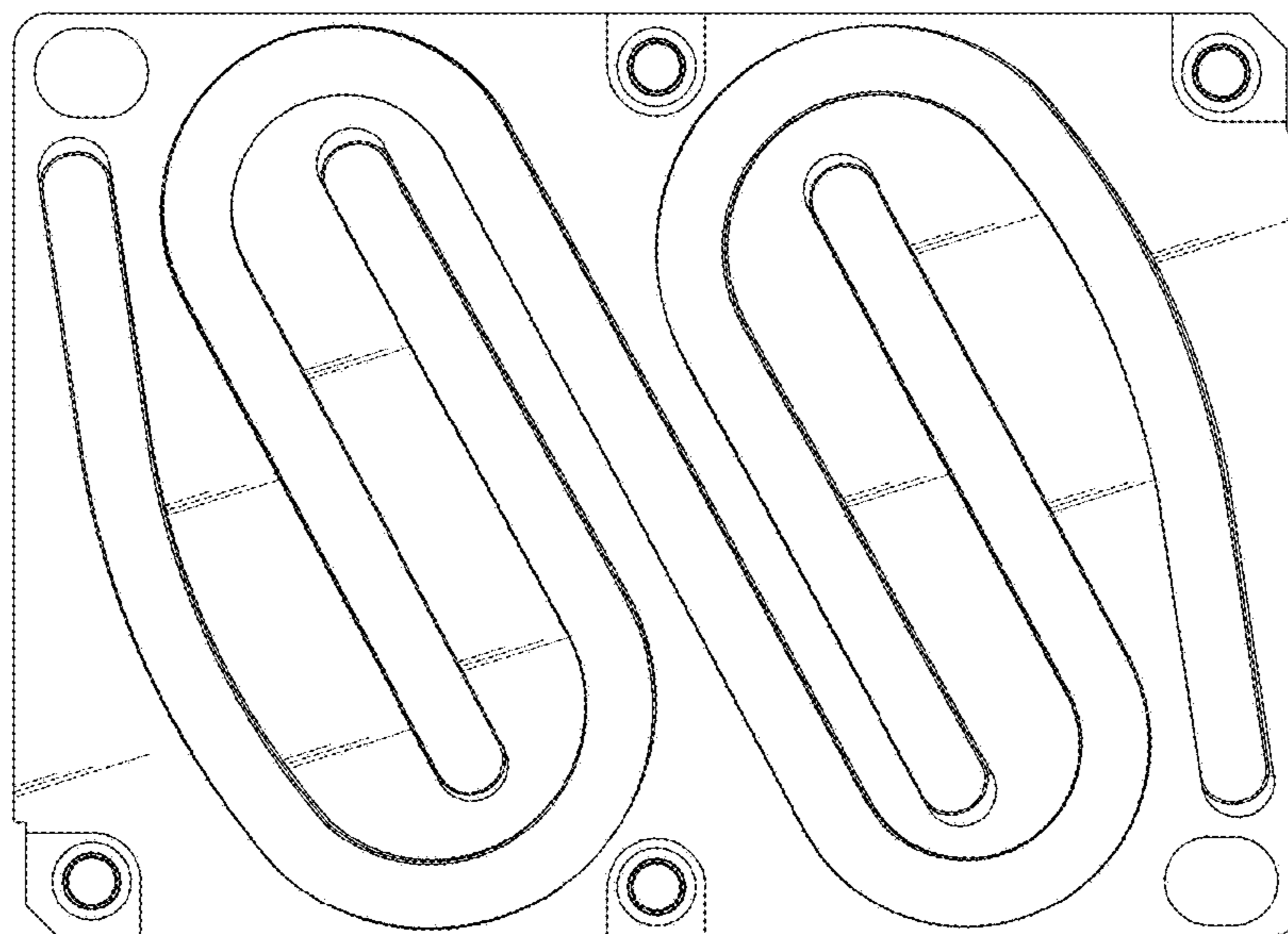

FIG. 8