



US00D819533S

(12) **United States Design Patent** (10) **Patent No.:** **US D819,533 S**
Choi et al. (45) **Date of Patent:** **** Jun. 5, 2018**

(54) **INSTRUMENT PANEL FOR A MOTOR VEHICLE**

(71) Applicants: **Byung Gyu Choi**, Troy, MI (US); **William Luther Chergosky**, San Marcos, CA (US); **Tsuyoshi Oba**, Aichi-gun (JP)

(72) Inventors: **Byung Gyu Choi**, Troy, MI (US); **William Luther Chergosky**, San Marcos, CA (US); **Tsuyoshi Oba**, Aichi-gun (JP)

(73) Assignee: **Toyota Jidosha Kabushiki Kaisha**, Toyota-shi, Aichi-ken (JP)

(**) Term: **15 Years**

(21) Appl. No.: **29/577,804**

(22) Filed: **Sep. 15, 2016**

(51) **LOC (11) Cl.** **12-16**

(52) **U.S. Cl.**
USPC **D12/192**

(58) **Field of Classification Search**
USPC D14/485, 489, 492, 488, 490, 157;
D20/28, 35; D12/192, 190, 345, 415,
D12/110, 114; 296/70, 24.3, 37.12;
702/165; 345/594; D10/113.4, 49, 46,
D10/98, 102, 103, 122, 123, 124, 125,
D10/126, 127; 715/839; D15/17, 28
CPC . B60R 21/045; B60R 2300/305; B60K 35/00;
G06F 3/04817; H04N 21/4307; H04N
21/4312

See application file for complete search history.

(56) **References Cited**

U.S. PATENT DOCUMENTS

D567,161 S *	4/2008	Motozaki	D12/192
D652,773 S *	1/2012	Kitajima	D12/192
D653,185 S *	1/2012	Senda	D12/192
D654,004 S *	2/2012	Hamajima	D12/192

D656,441 S *	3/2012	Cheung	D12/192
D658,554 S *	5/2012	Tasaki	D12/192
D697,462 S *	1/2014	Yamazaki	D12/192
D699,171 S *	2/2014	Matsuo	D12/192
D704,114 S *	5/2014	Masakawa	D12/192
D705,145 S *	5/2014	Mangan	D12/192

(Continued)

OTHER PUBLICATIONS

2018 Camry XSE Dashboard, Toyota, posted at nydailynews.com, date and author not listed © 2017 NYDailyNews.com, online, site visited Dec. 29, 2017. Available from Internet, URL: <http://www.nydailynews.com/autos/photos-2018-toyota-camry-gallery-1.2941627?pmSlide=1.2941639> (Year: 0000).*

(Continued)

Primary Examiner — Shannon W Morgan

Assistant Examiner — Altaira J Swangin

(74) *Attorney, Agent, or Firm* — Finnegan, Henderson, Farabow, Garrett & Dunner, L.L.P.

(57) **CLAIM**

The ornamental design for an instrument panel for a motor vehicle, as shown and described.

DESCRIPTION

FIG. 1 is a front perspective view of an instrument panel for a motor vehicle, showing our new design;

FIG. 2 is a front view thereof;

FIG. 3 is a rear view thereof;

FIG. 4 is a right side view thereof;

FIG. 5 is a left side view thereof;

FIG. 6 is a top view thereof; and,

FIG. 7 is a bottom view thereof.

Our design includes a mirror image of the embodiment depicted. The de-emphasized and halftone portions shown in the photographs illustrate environmental structure of an instrument panel for a motor vehicle that forms no part of the claimed design.

1 Claim, 7 Drawing Sheets

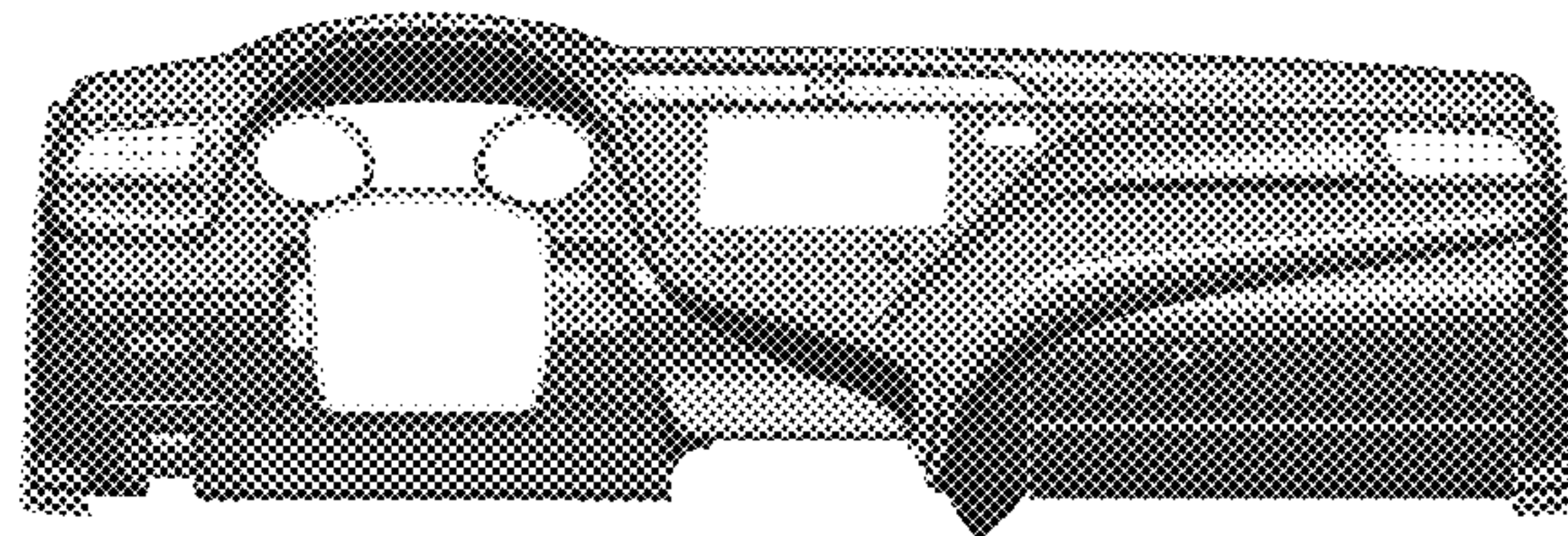
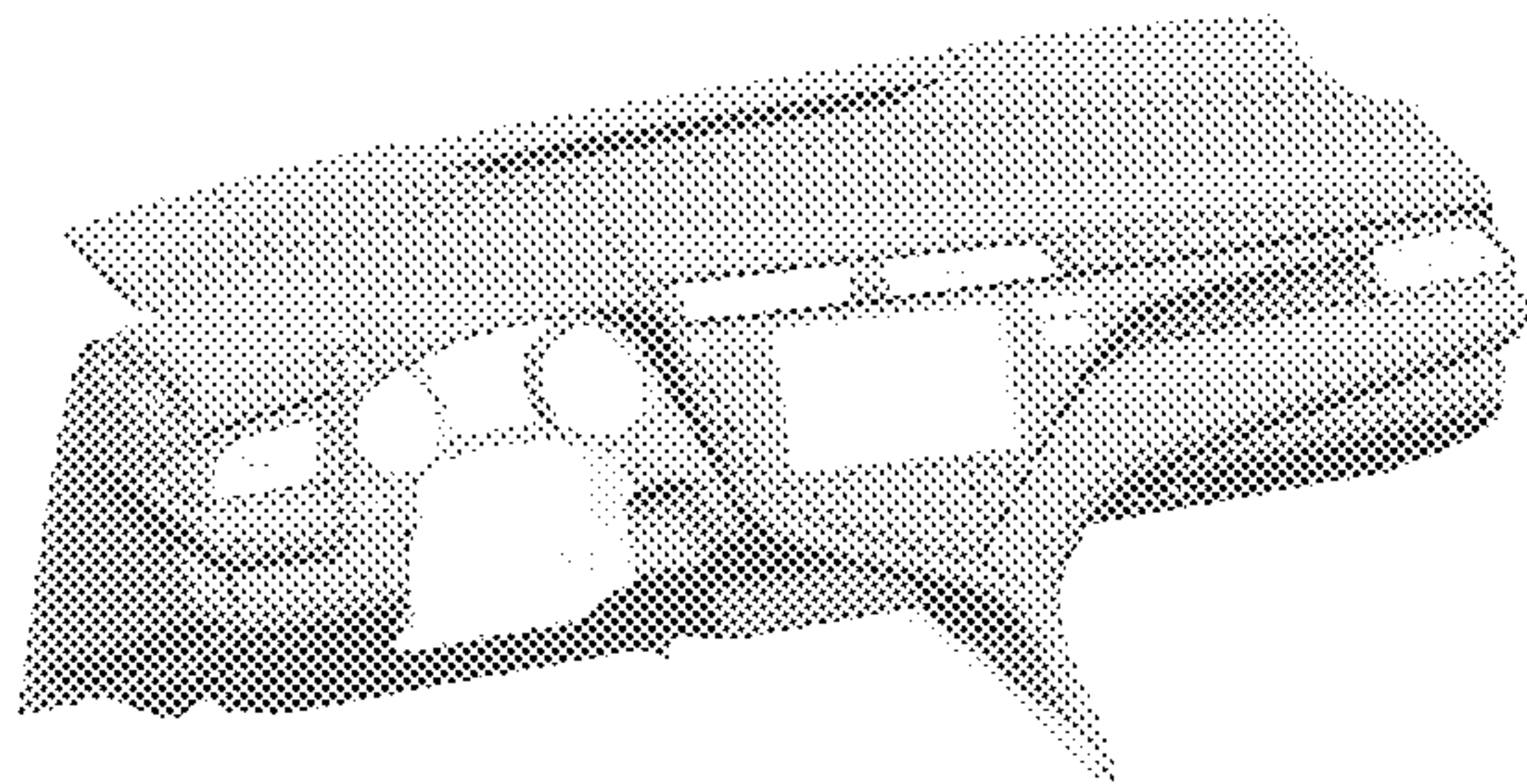

(56)

References Cited

U.S. PATENT DOCUMENTS

D705,711 S	*	5/2014	Yamamoto	D12/192
D718,200 S	*	11/2014	Arnaout	D12/192
D726,611 S	*	4/2015	Higashimori	D12/192
D727,813 S	*	4/2015	Yaguchi	D12/192
D730,793 S	*	6/2015	Ishikawa	D12/192
D733,021 S	*	6/2015	Takagi	D12/192
D737,186 S	*	8/2015	Nakao	D12/192
D761,709 S	*	7/2016	Shimizu	D12/192
D763,154 S	*	8/2016	Chang	D12/192
D770,348 S	*	11/2016	Shimizu	D12/192
D771,541 S	*	11/2016	Shouno	D12/192
D776,029 S	*	1/2017	Callum	D12/192
D778,796 S	*	2/2017	Gommier	D12/192

OTHER PUBLICATIONS

Clublexus.com, URL: <http://www.clublexus.com/forums/rx-4th-gen-2016-present/>; Model: Lexus RX (2016); Mfg.: Toyota; available on at least Jun. 3, 2015.

Motortrend.com, URL: <http://www.motortrend.com/news/infiniti-g80-inspiration-concept-first-look/>; Model: Infiniti Q80 concept; Mfg.: Nissan; available on at least Jun. 3, 2015.

* cited by examiner

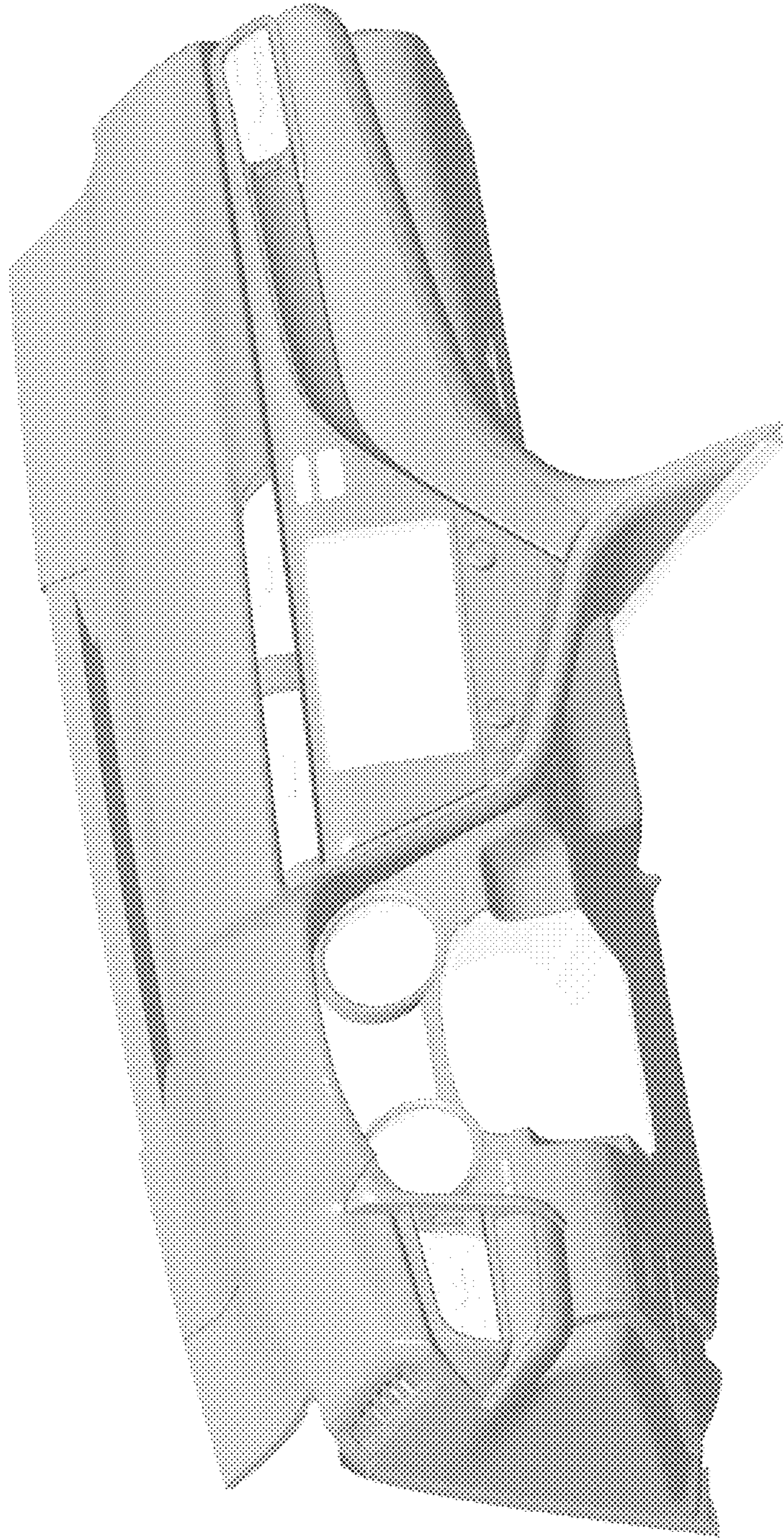

FIG. 1

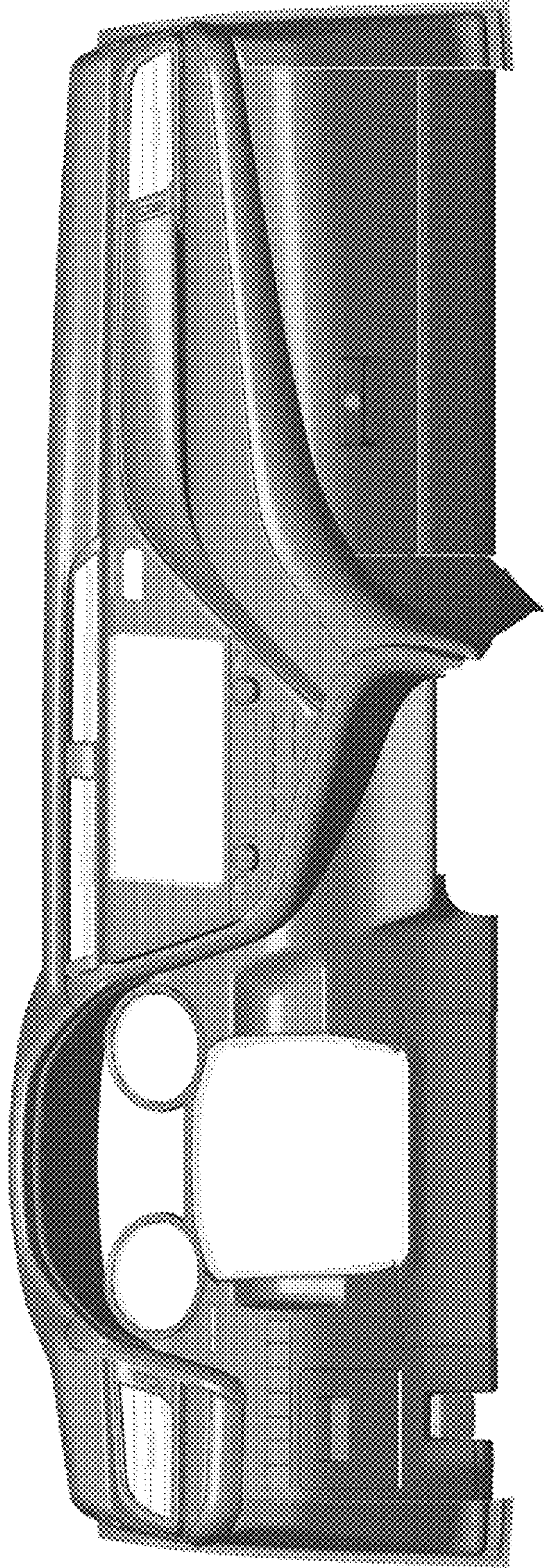

FIG. 2

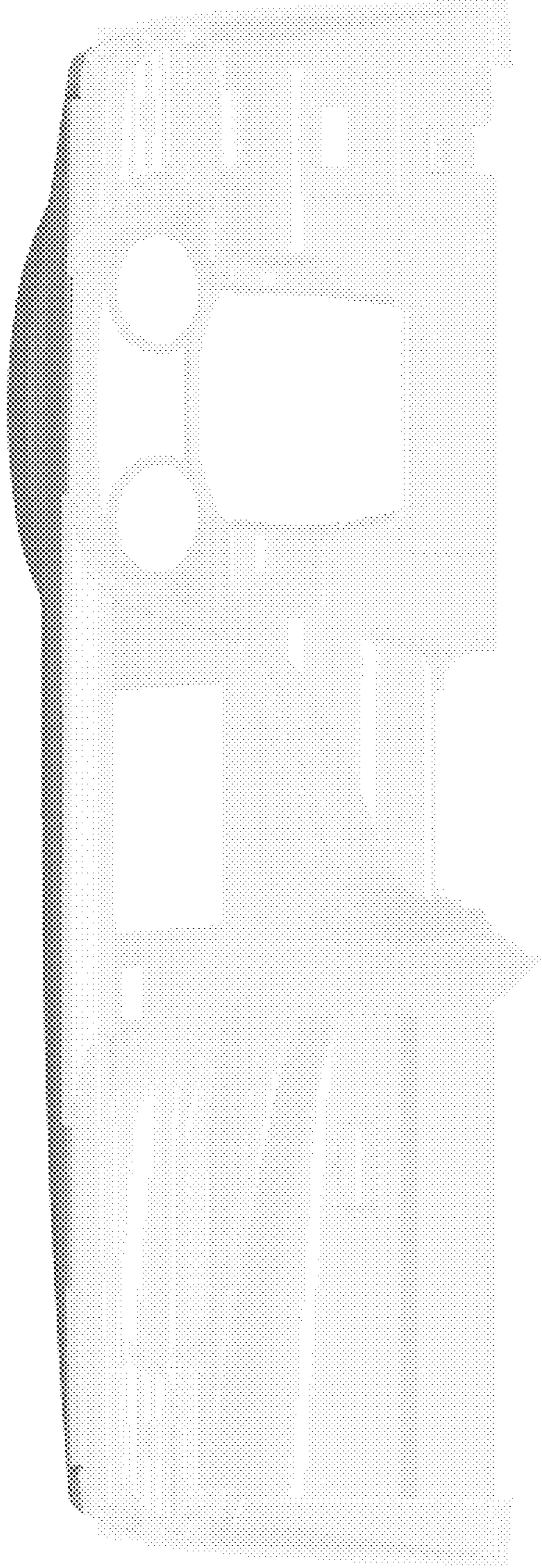

FIG. 3

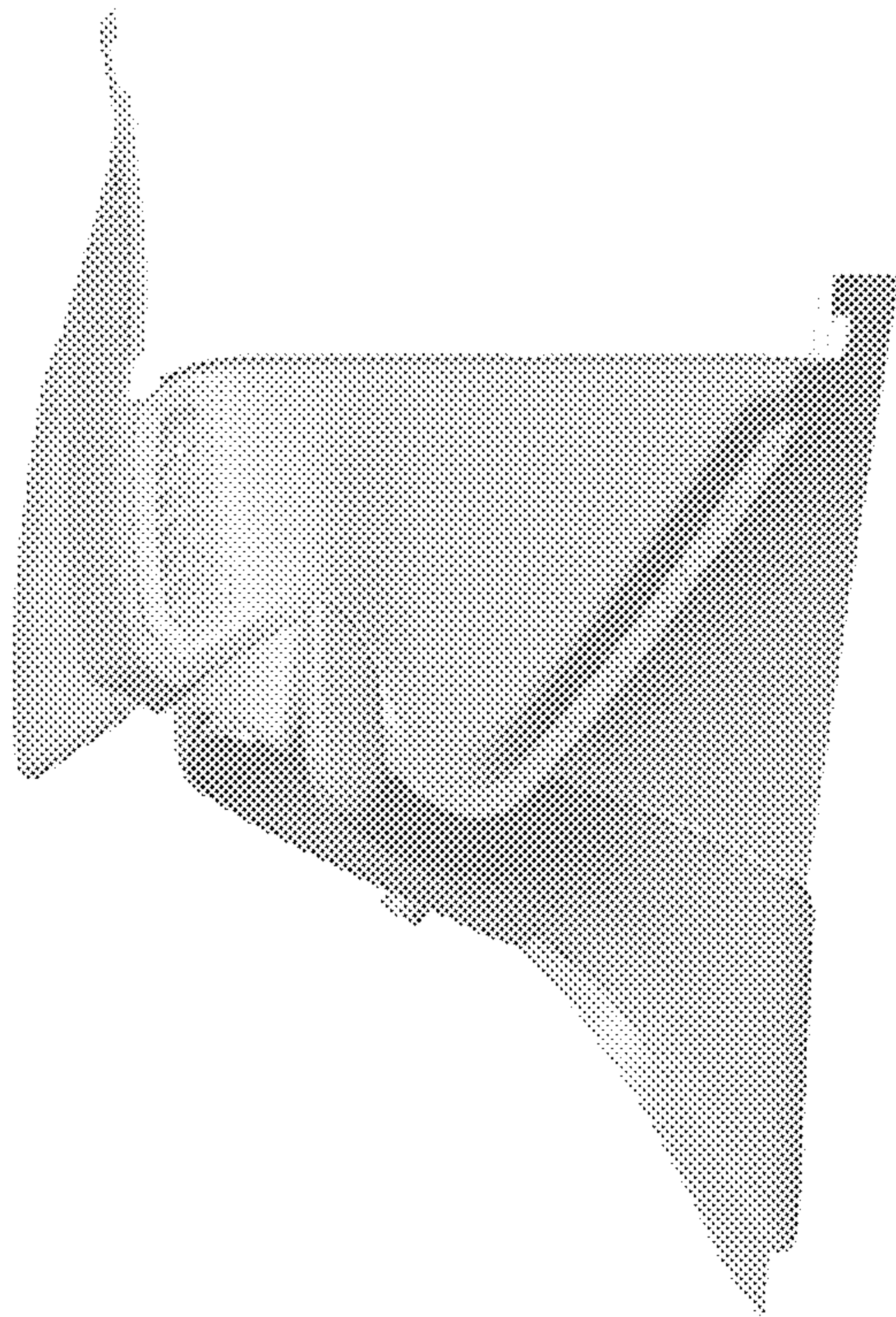

FIG. 4

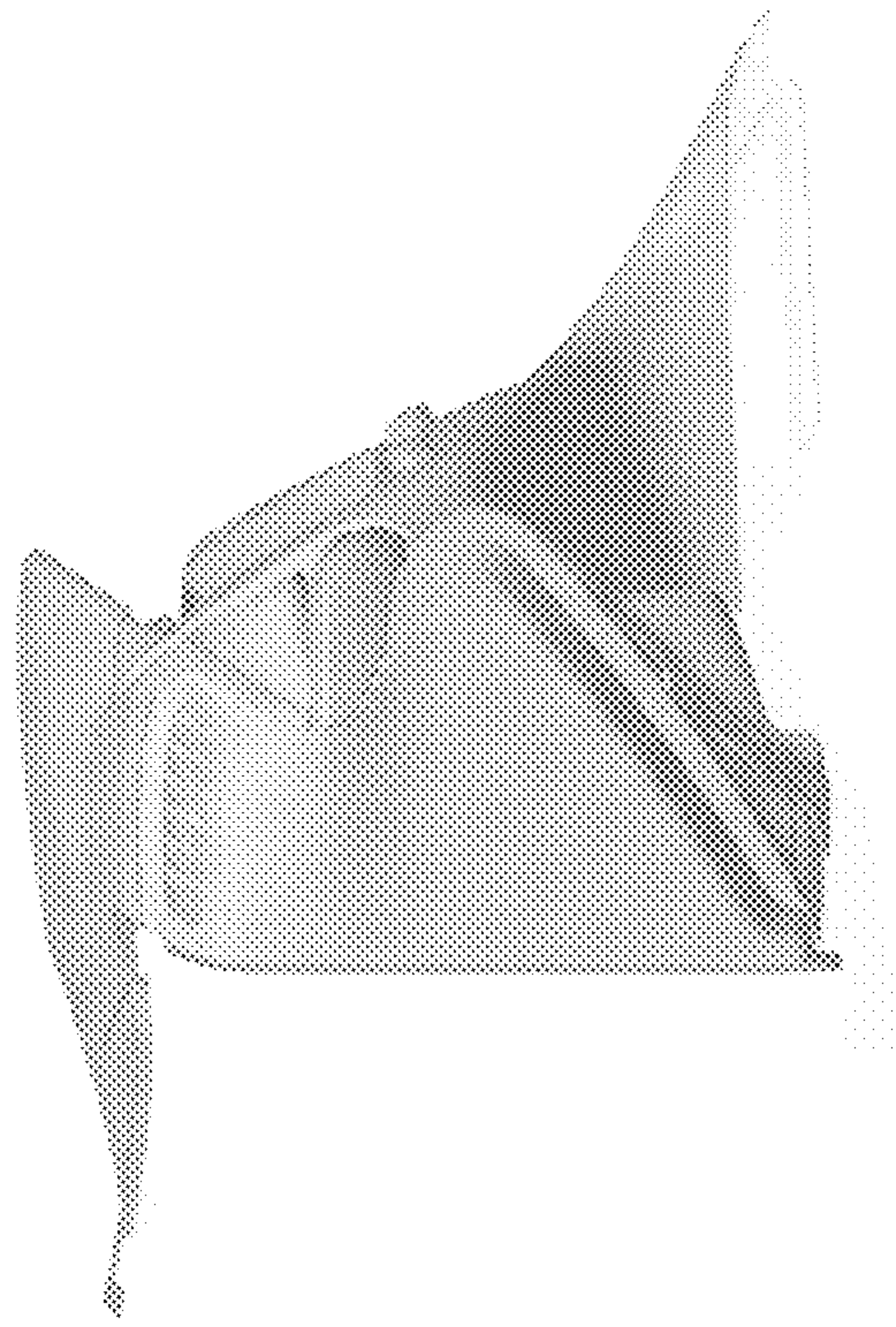

FIG. 5

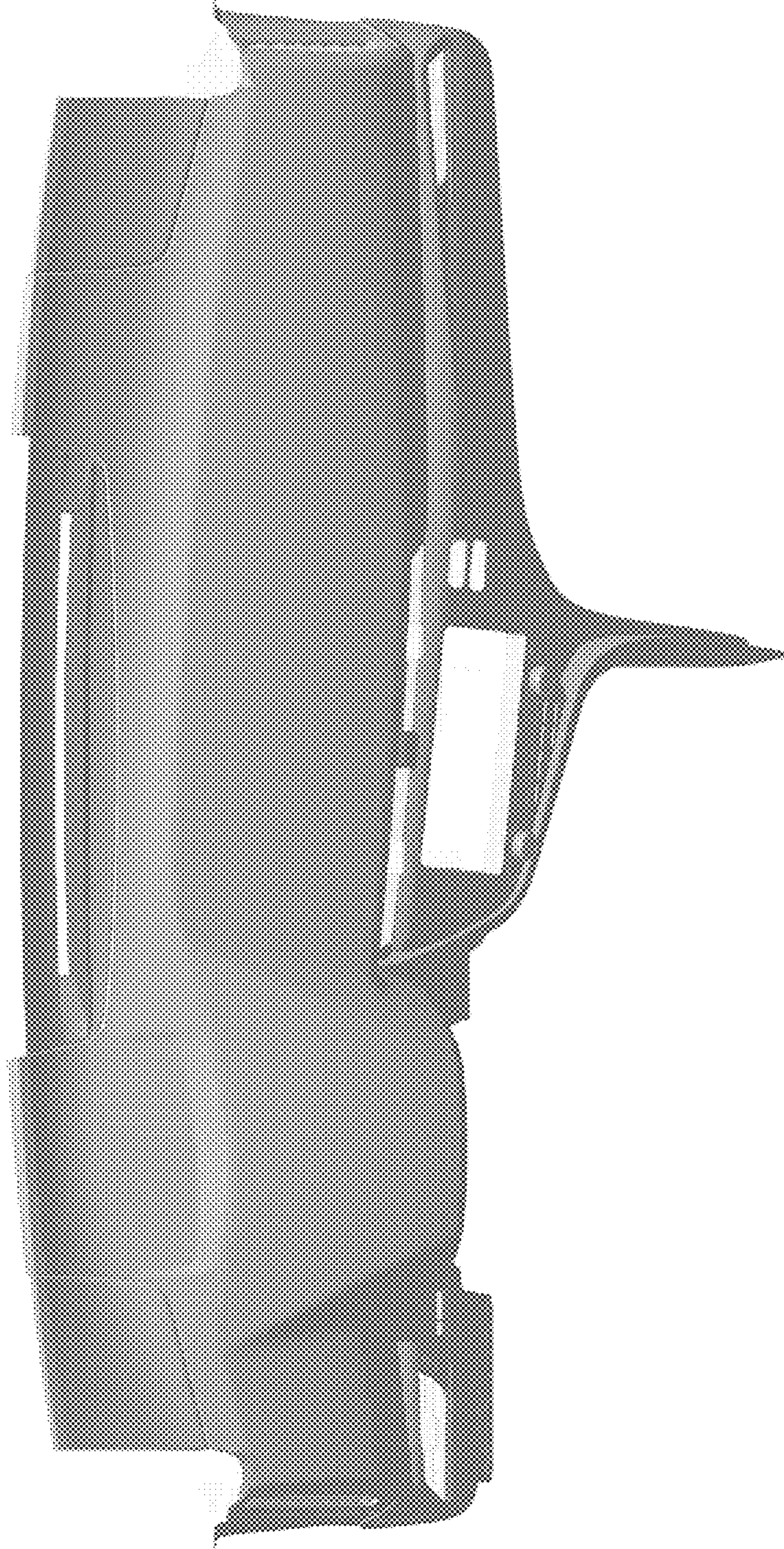

FIG. 6

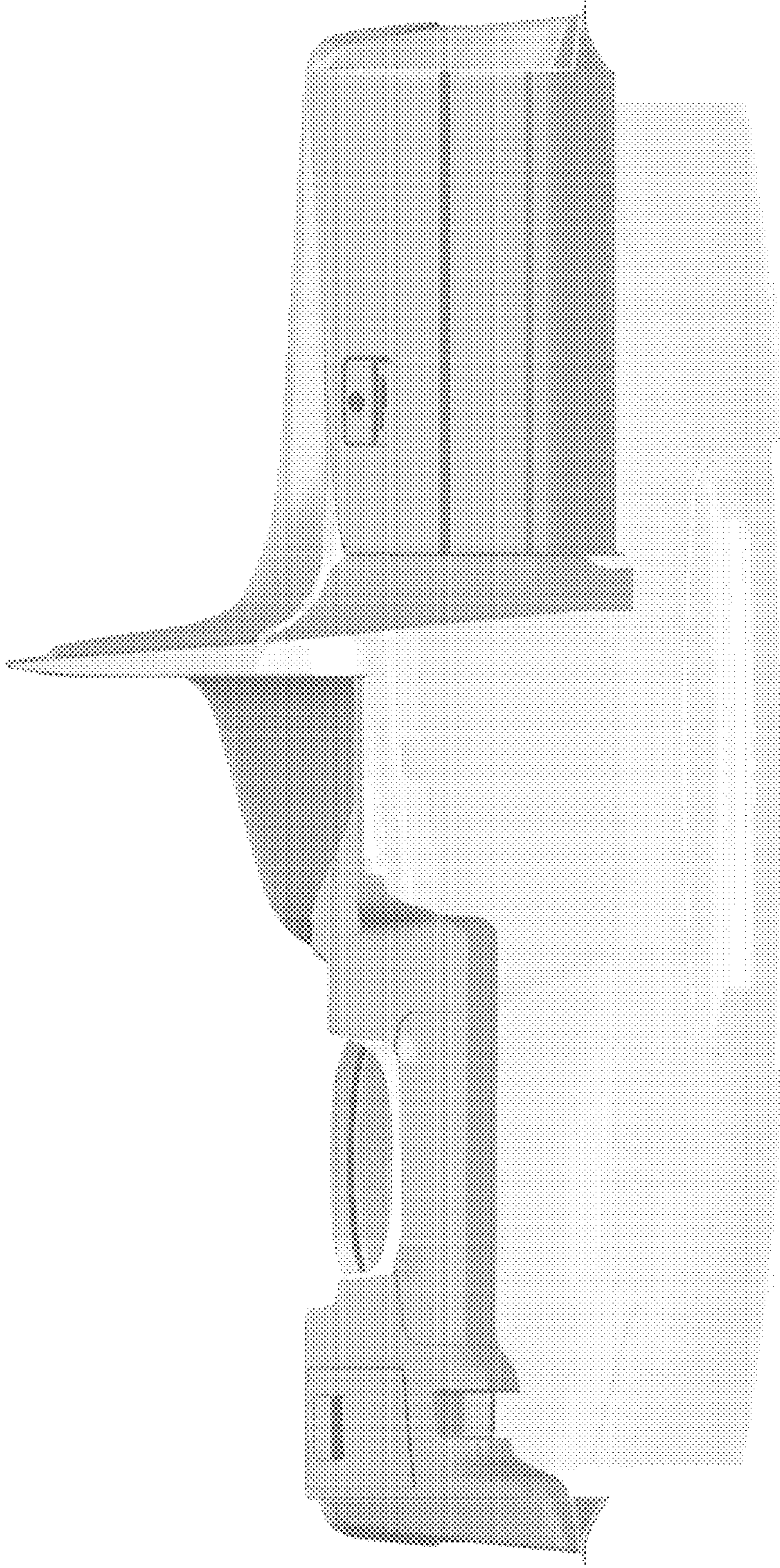

FIG. 7