



US00D819499S

(12) **United States Design Patent** (10) **Patent No.:** **US D819,499 S**
Hahn-Woernle (45) **Date of Patent:** **** Jun. 5, 2018**

(54) **MOTORCYCLE, TOY, AND/OR REPLICAS THEREOF**

(71) Applicant: **Bayerische Motoren Werke Aktiengesellschaft, Munich (DE)**

(72) Inventor: **Christian Siegfried Erhard Hahn-Woernle, Munich (DE)**

(73) Assignee: **Bayerische Motoren Werke Aktiengesellschaft, Munich (DE)**

(**) Term: **15 Years**

(21) Appl. No.: **29/579,986**

(22) Filed: **Oct. 5, 2016**

(30) **Foreign Application Priority Data**

Apr. 8, 2016 (DE) 40 2016 100 455

(51) **LOC (11) Cl.** **12-11**

(52) **U.S. Cl.**
USPC **D12/110**

(58) **Field of Classification Search**
USPC D12/110, 111, 112, 114, 117, 119
CPC ... B62K 3/00; B62K 3/02; B62K 5/00; B62K 5/003; B62K 5/007; B62K 5/01; B62K 11/00; B62K 11/02; B62K 11/04; B62K 15/00; B62K 2202/00; F16D 43/12
See application file for complete search history.

(56) **References Cited**

U.S. PATENT DOCUMENTS

D500,463 S	1/2005	Heinrich et al.	
D587,172 S *	2/2009	Buckan	D12/110
D669,397 S *	10/2012	Isokari	D12/110
D669,821 S *	10/2012	Nishihara	D12/110
D693,275 S *	11/2013	Murakami	D12/110
D695,153 S	12/2013	Buckan	

D695,154 S *	12/2013	Buckan	D12/110
D723,431 S *	3/2015	Noguchi	D12/110
D735,085 S *	7/2015	Buckan	D12/110
D736,677 S *	8/2015	Iimura	D12/110
D755,681 S *	5/2016	Martin	D12/110
D755,682 S *	5/2016	Hahn-Woernle	D12/110
D758,924 S *	6/2016	Tamura	D12/110
D795,746 S *	8/2017	Akita	D12/110
2009/0038871 A1 *	2/2009	Inomori	F16D 43/12 180/219

FOREIGN PATENT DOCUMENTS

EM	000106513-0001	12/2004
EM	002084772-0001	2/2015

* cited by examiner

Primary Examiner — Karen S Acker

Assistant Examiner — Jerry Shiuan-Hua Hsu

(74) *Attorney, Agent, or Firm* — Crowell & Moring LLP

(57) **CLAIM**

The ornamental design for a motorcycle, toy, and/or replicas thereof, as shown and described.

DESCRIPTION

This application contains subject matter related to the following co-pending U.S. design patent application: Application Ser. No. 29/567,189, filed Jun. 7, 2016 and entitled "Motorcycle, Toy, and/or replicas thereof." FIG. 1 is a left, front perspective view of a motorcycle, toy, and/or replicas thereof according to the design; FIG. 2 is a left side view thereof; FIG. 3 is a right side view thereof; FIG. 4 is a front view thereof; FIG. 5 is a rear view thereof; FIG. 6 is a top view thereof; and, FIG. 7 is a bottom view thereof.

1 Claim, 7 Drawing Sheets

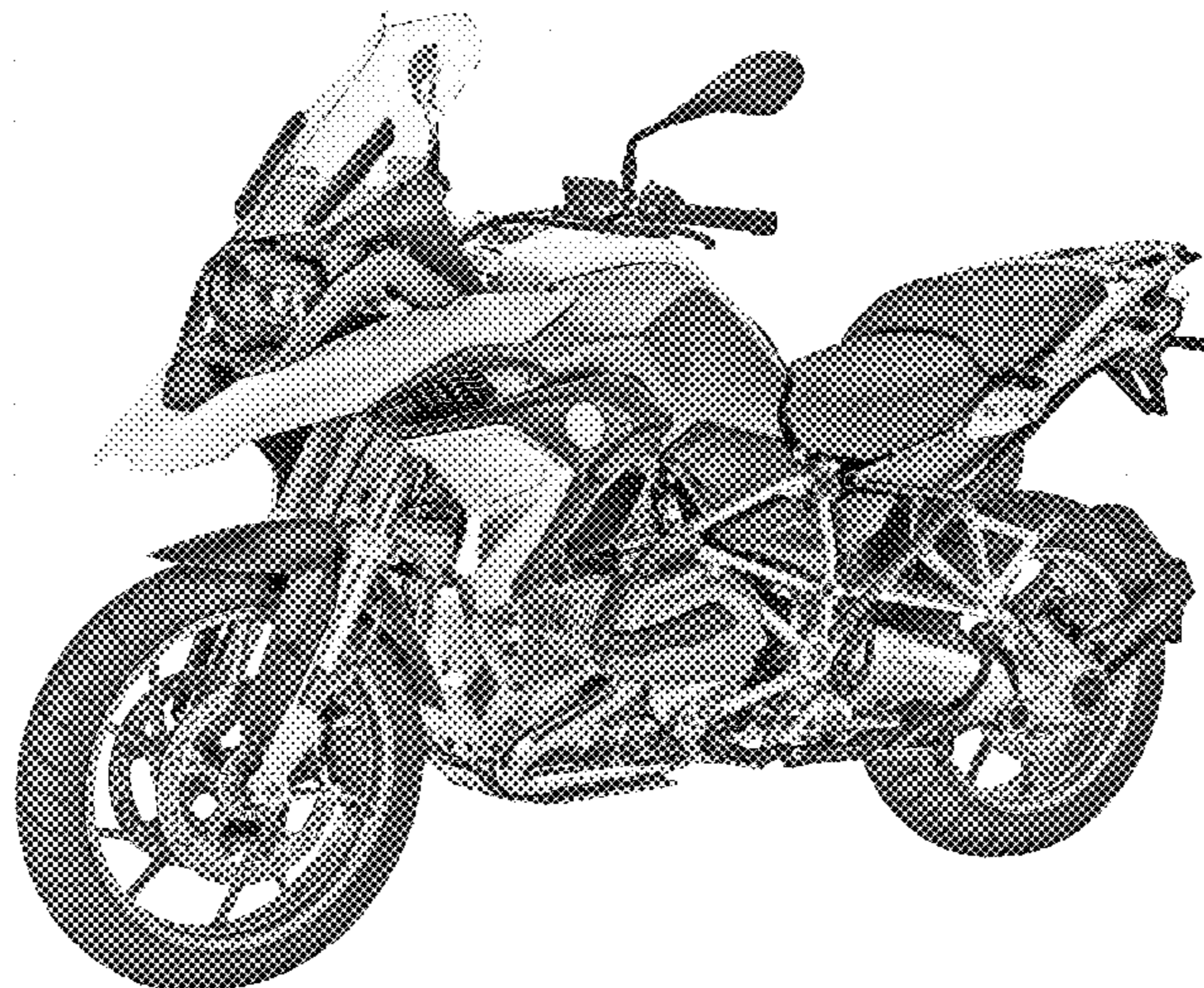

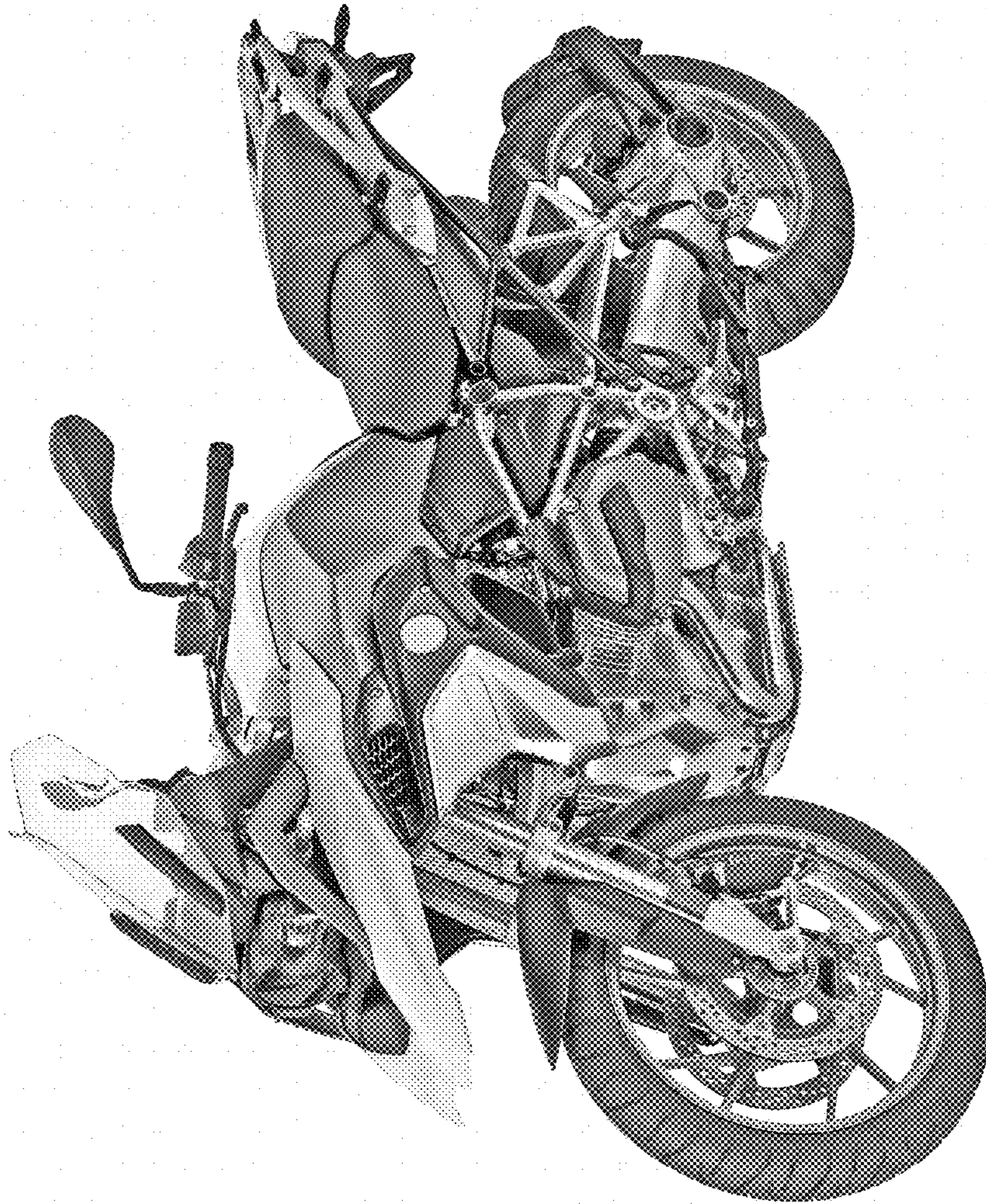

Fig. 1

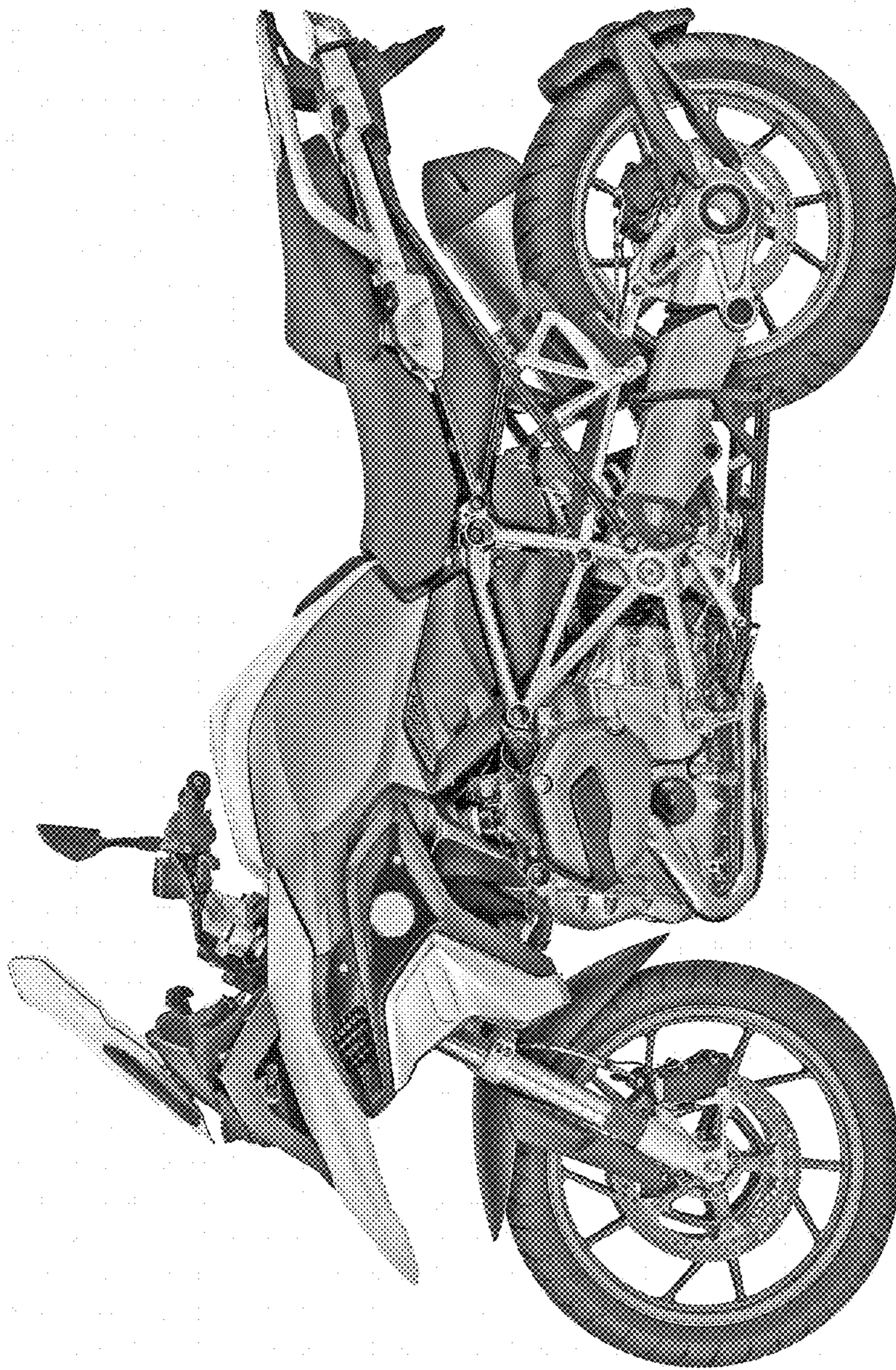

Fig. 2

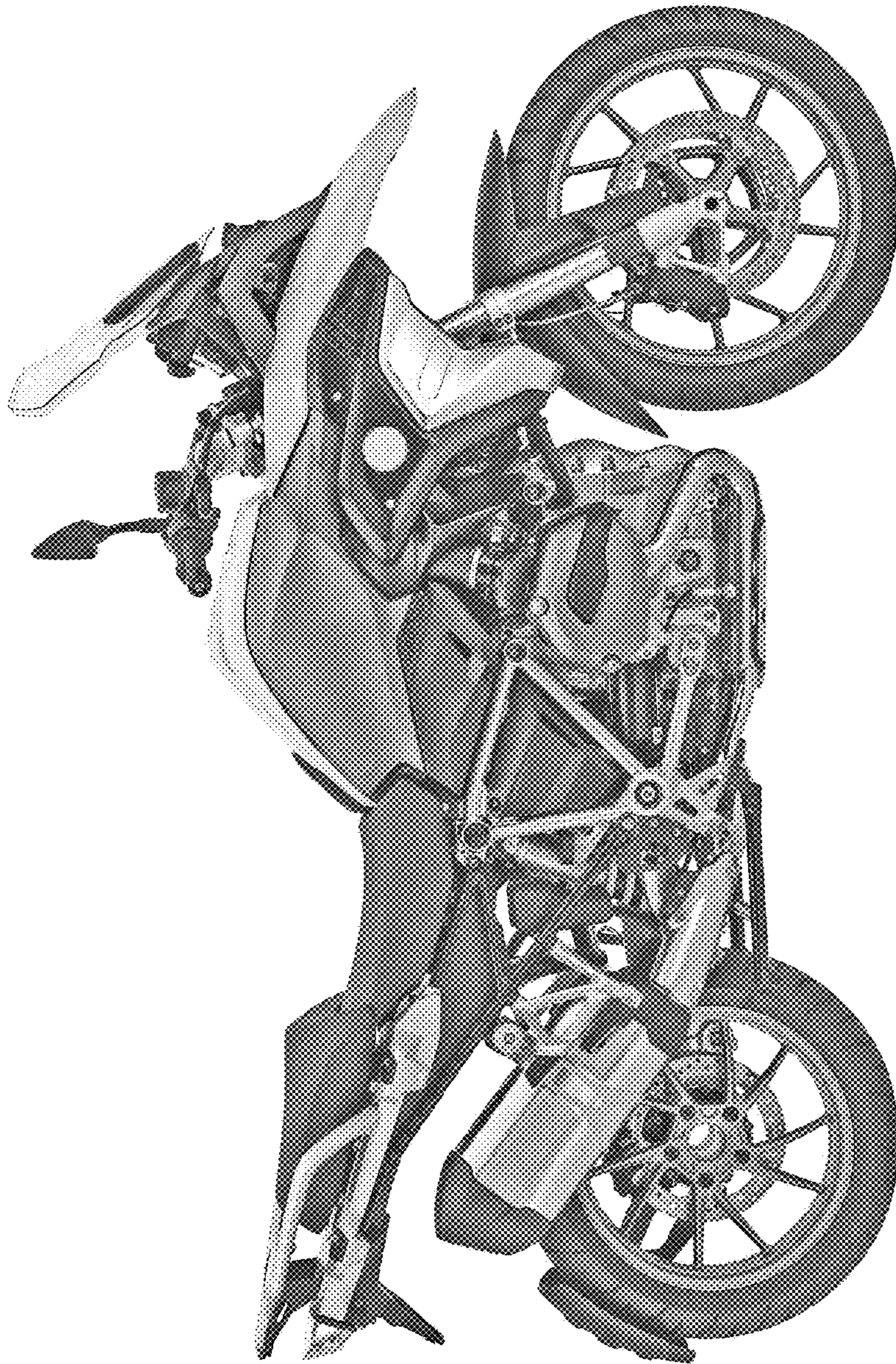

Fig. 3

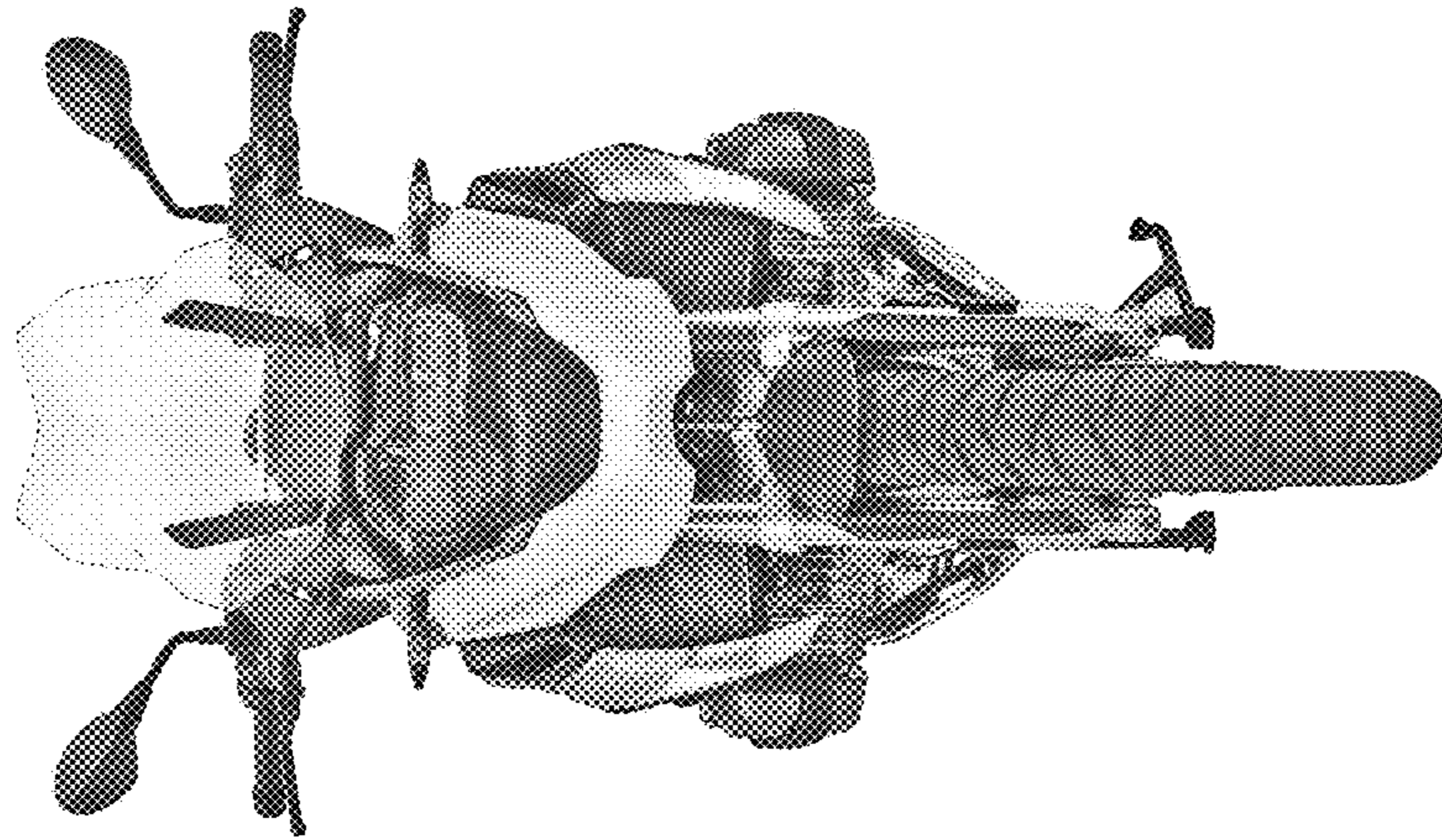

Fig. 4

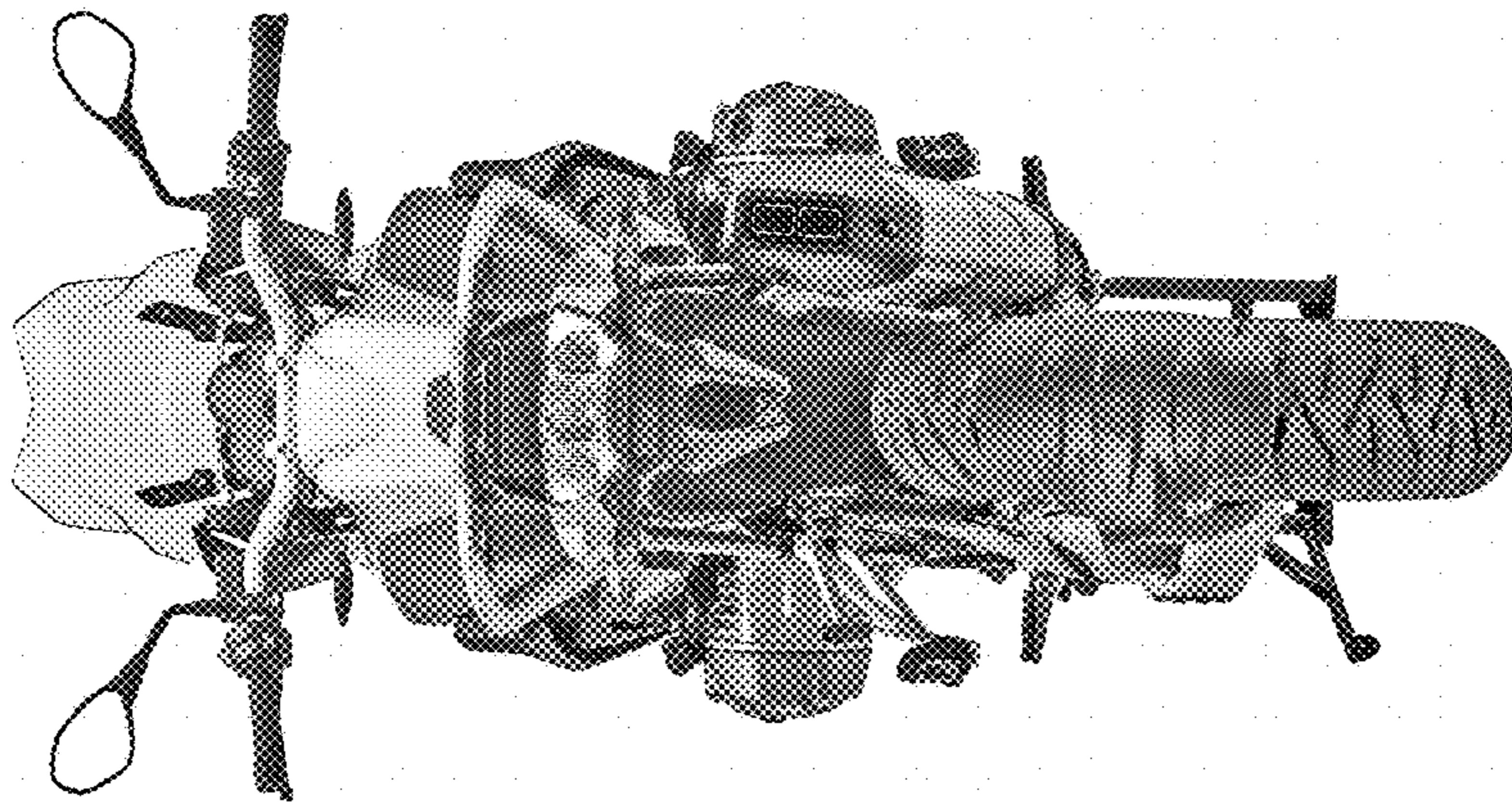

Fig. 5

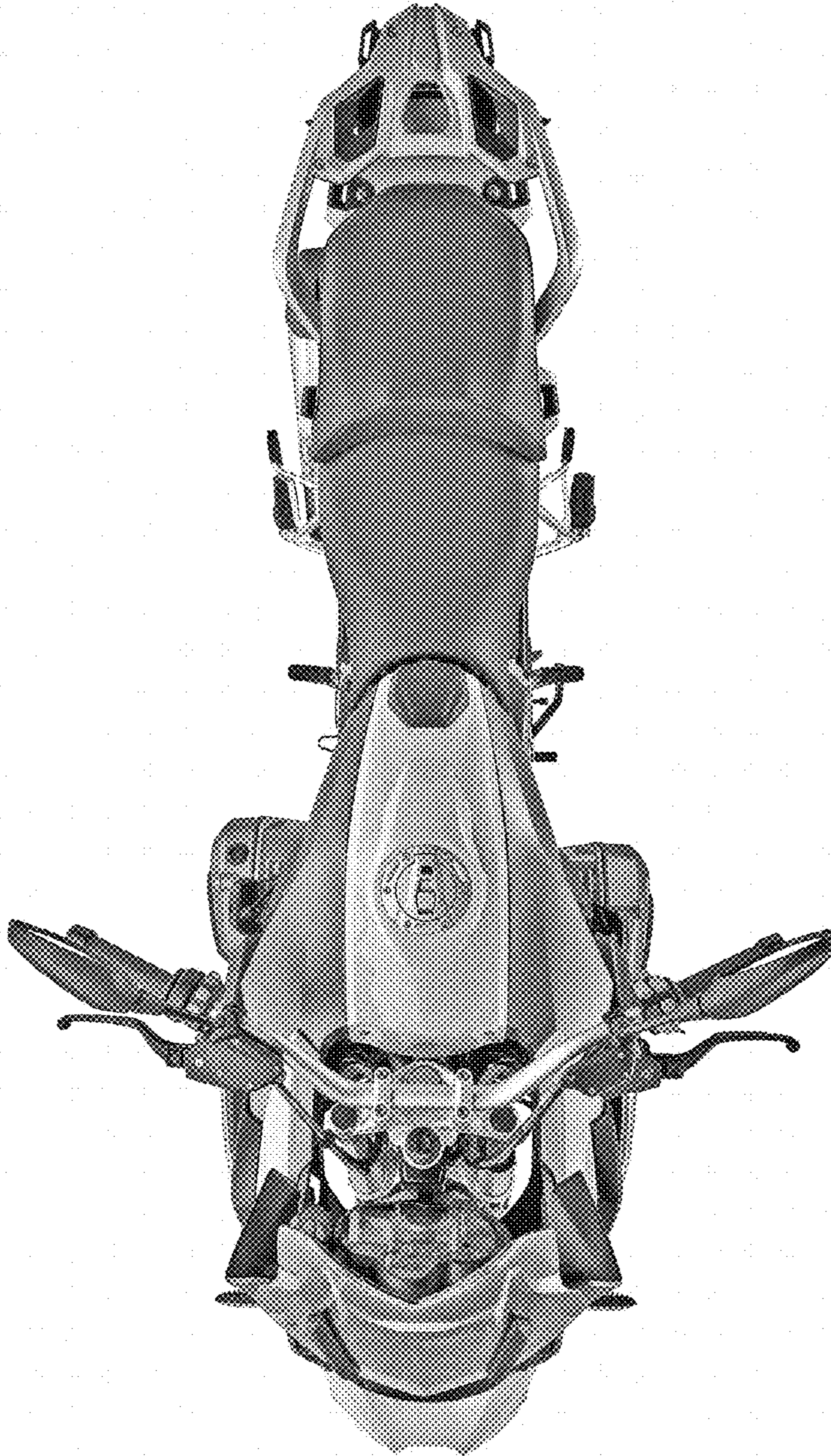

Fig. 6

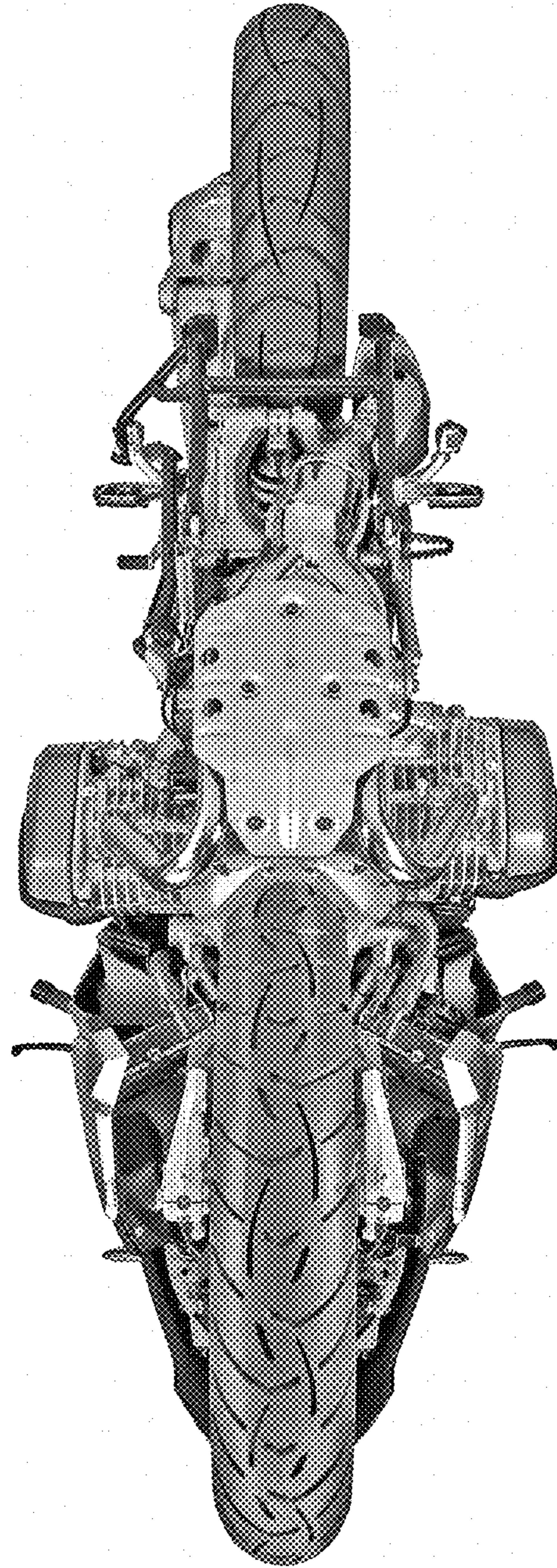

Fig. 7