



US00D819472S

(12) **United States Design Patent**
Lanham et al.

(10) **Patent No.:** **US D819,472 S**
(45) **Date of Patent:** **** Jun. 5, 2018**

- (54) **FLOWMETER CASE**
 - (71) Applicant: **Micro Motion, Inc.**, Boulder, CO (US)
 - (72) Inventors: **Gregory Treat Lanham**, Longmont, CO (US); **Christopher A. Werbach**, Loveland, CO (US); **Linda Robb**, Bloomfield, CO (US)
 - (73) Assignee: **Micro Motion, Inc.**, Boulder, CO (US)
 - (**) Term: **15 Years**
 - (21) Appl. No.: **29/586,326**
 - (22) Filed: **Dec. 2, 2016**
 - (51) **LOC (11) Cl.** **10-04**
 - (52) **U.S. Cl.**
USPC **D10/96**
 - (58) **Field of Classification Search**
USPC D10/96
CPC G01F 1/8472; G01F 1/8481; G01F 1/8468;
G01F 1/8436; G01F 1/8477; G01F
1/8418; G01F 1/8422; G01F 1/8427;
G01F 1/8431; G01F 1/844; G01F 1/8445;
G01F 1/8486; G01F 1/849; G01F 1/8495;
G01F 25/00; G01F 25/0007
- See application file for complete search history.

- (56) **References Cited**
U.S. PATENT DOCUMENTS
D668,979 S * 10/2012 Robb D10/96
D674,302 S * 1/2013 Robb D10/96
D741,737 S * 10/2015 Feng D10/96
D744,362 S * 12/2015 Feng D10/96
9,200,937 B2 * 12/2015 Werbach G01F 1/8404

* cited by examiner
Primary Examiner — Antoine Duval Davis
(74) *Attorney, Agent, or Firm* — The Ollila Law Group LLC

(57) **CLAIM**
The ornamental design for a flowmeter case, substantially as shown and described.

DESCRIPTION
FIG. 1 is a perspective view of a flowmeter case showing our new design;
FIG. 2 is a front elevation view thereof;
FIG. 3 is a rear elevation view thereof;
FIG. 4 is a right side elevation view thereof;
FIG. 5 is a left side elevation view thereof;
FIG. 6 is a top plan view thereof; and,
FIG. 7 is a bottom plan view thereof.
The flowmeter case is not limited to the scale shown herein.

1 Claim, 5 Drawing Sheets

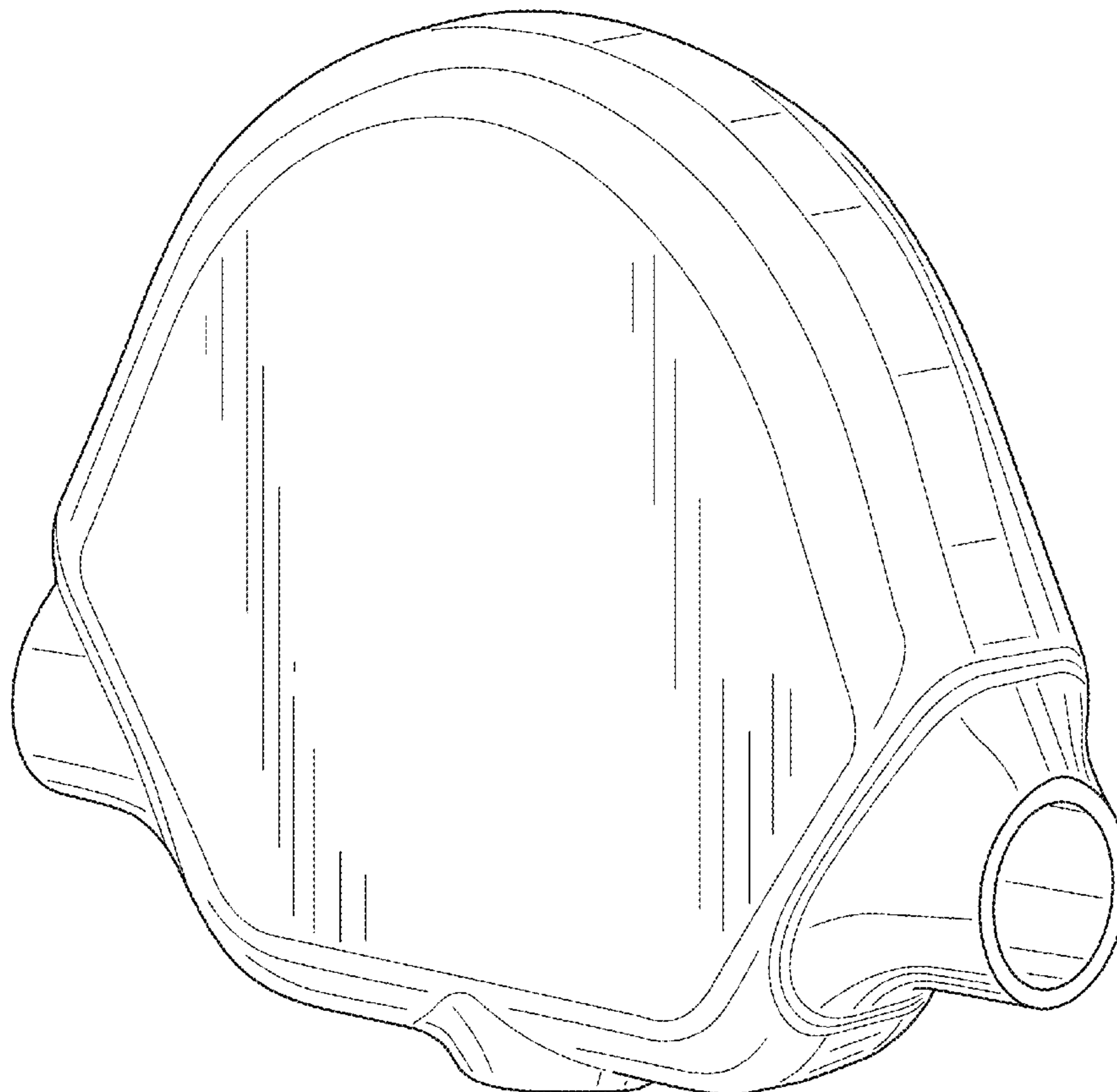

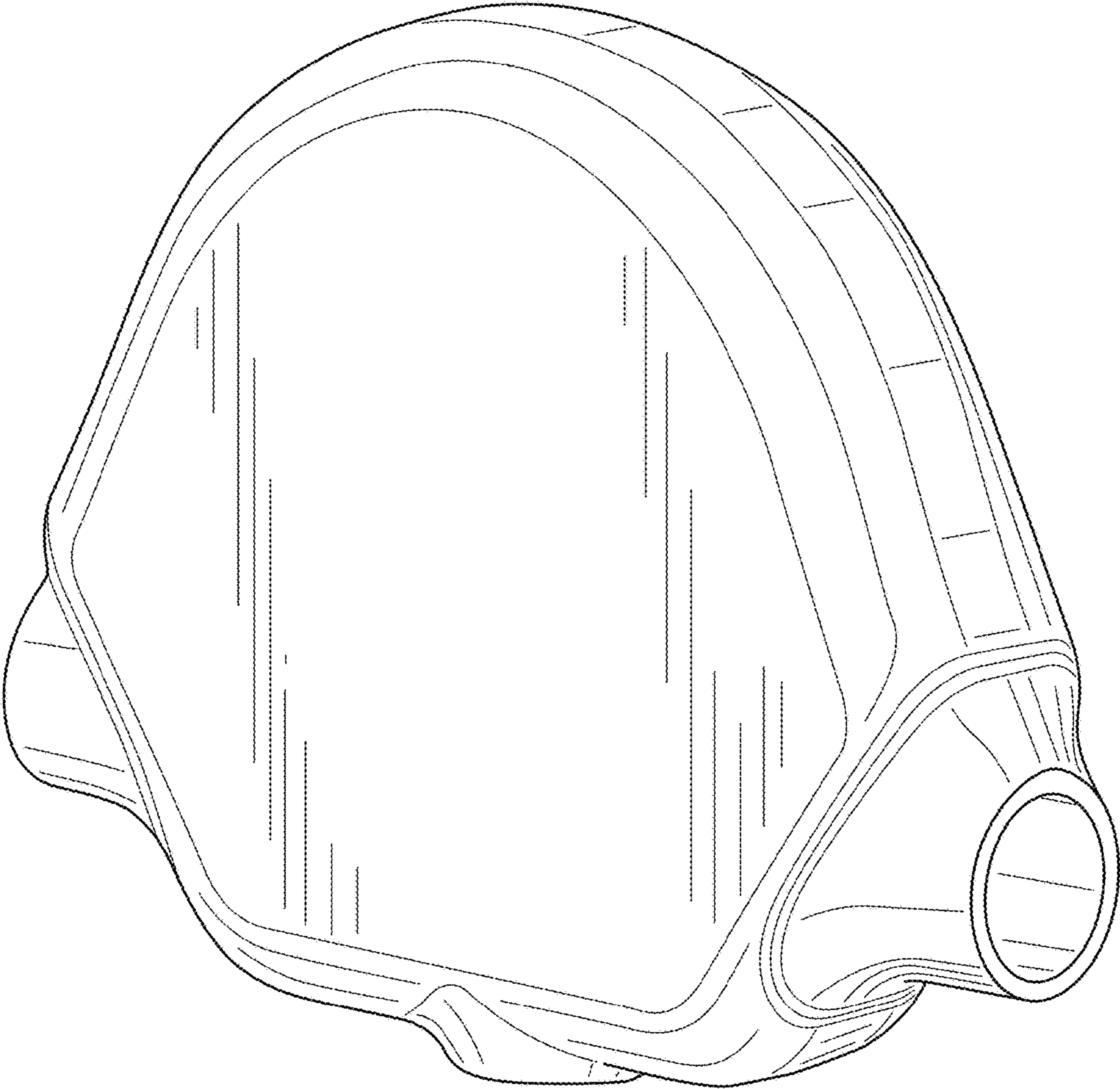

FIG. 1

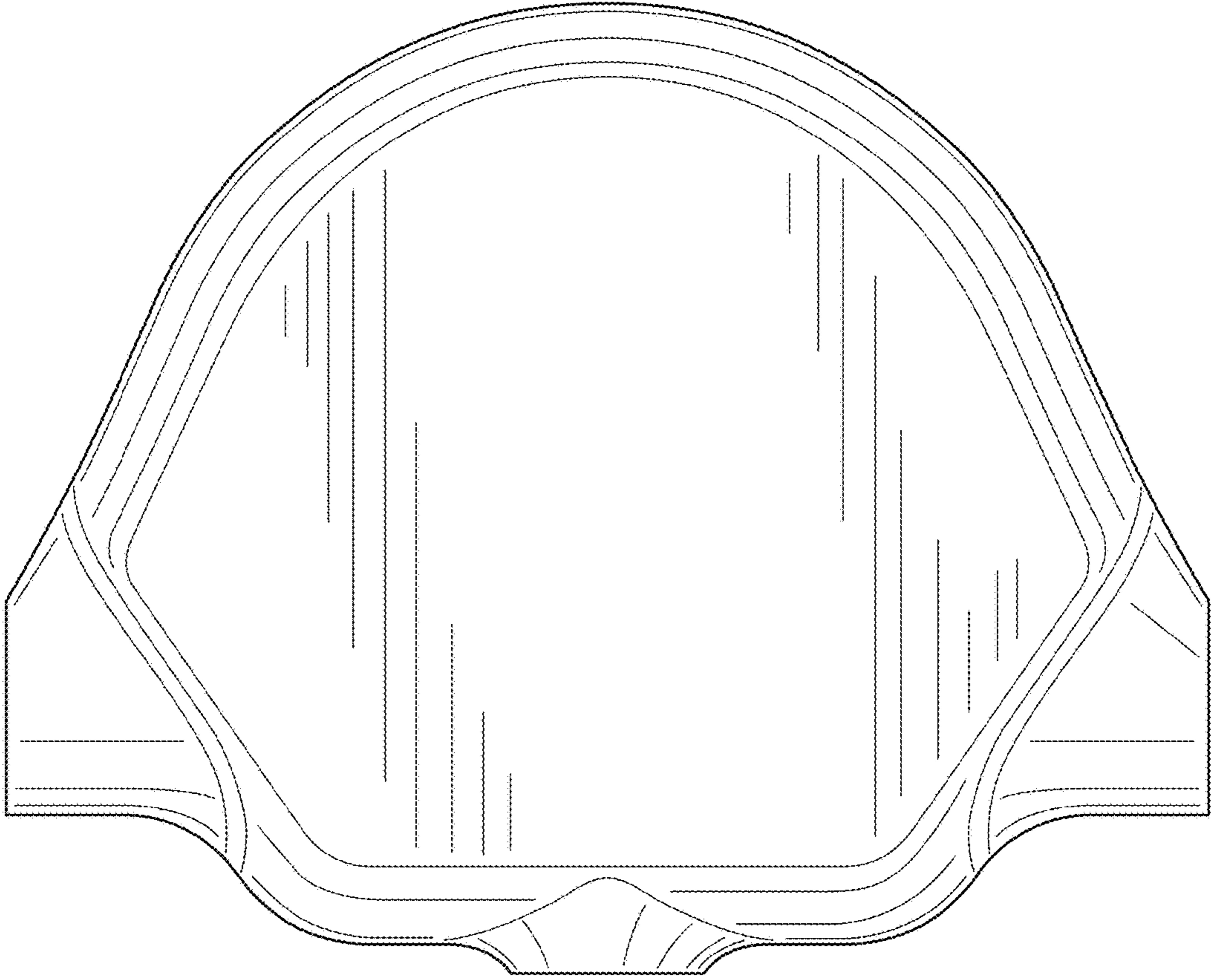

FIG.2

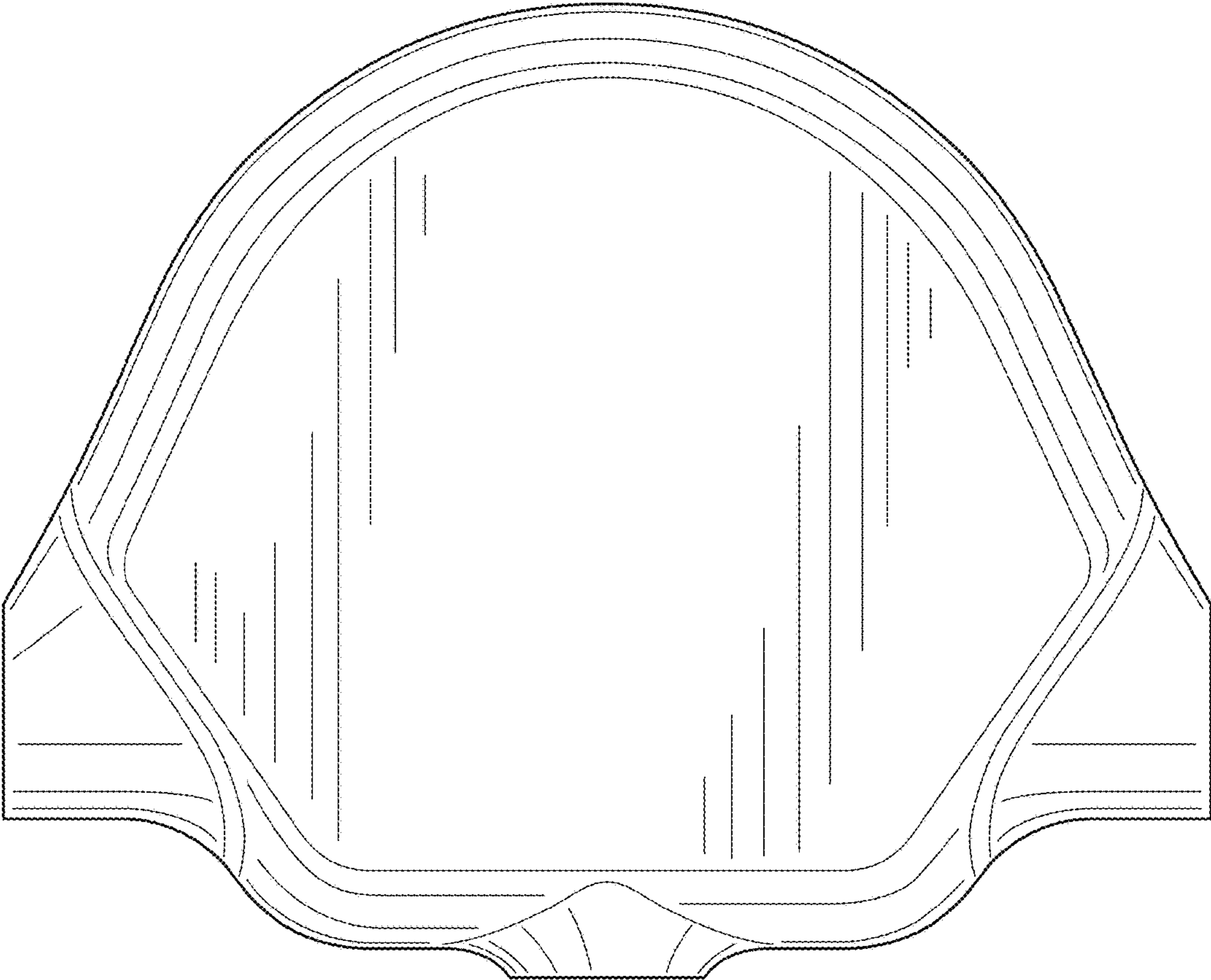

FIG.3

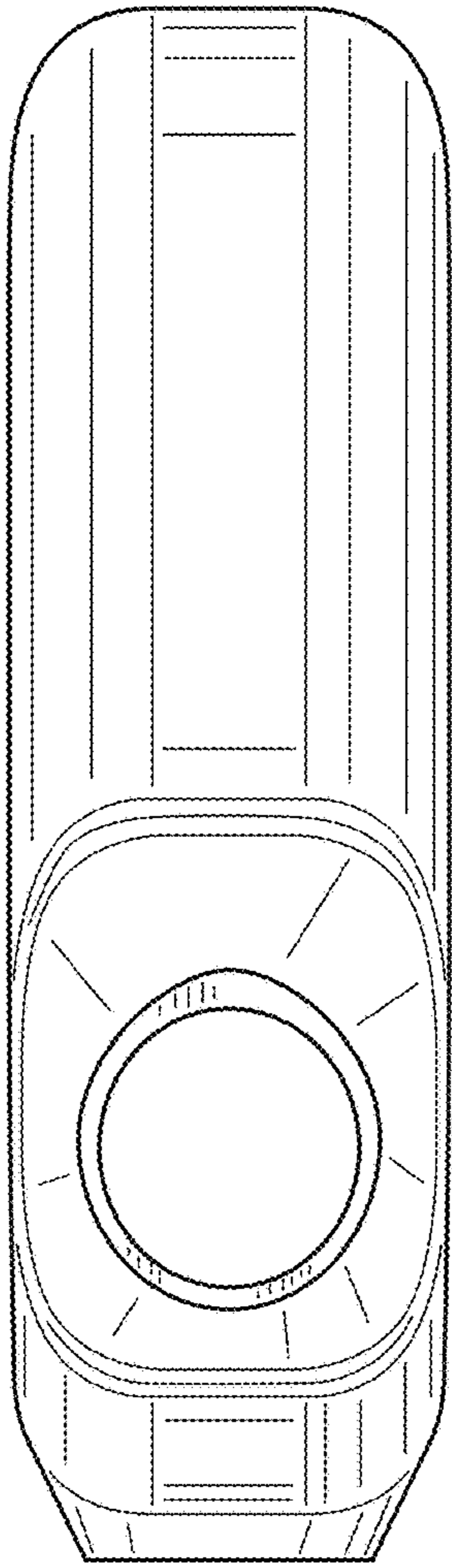

FIG.4

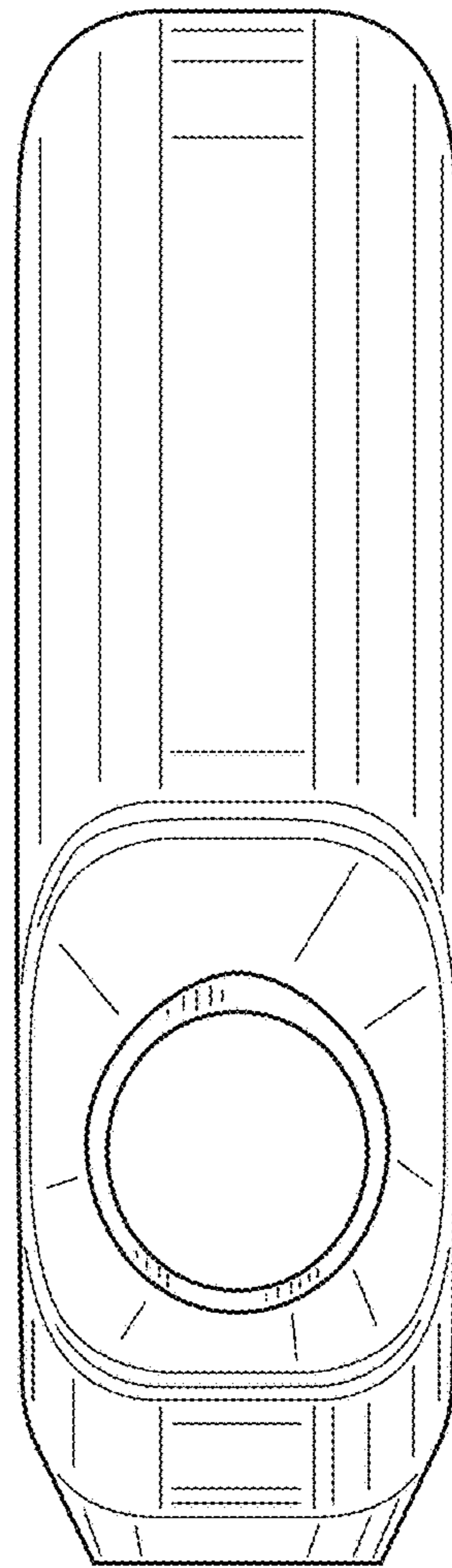

FIG.5

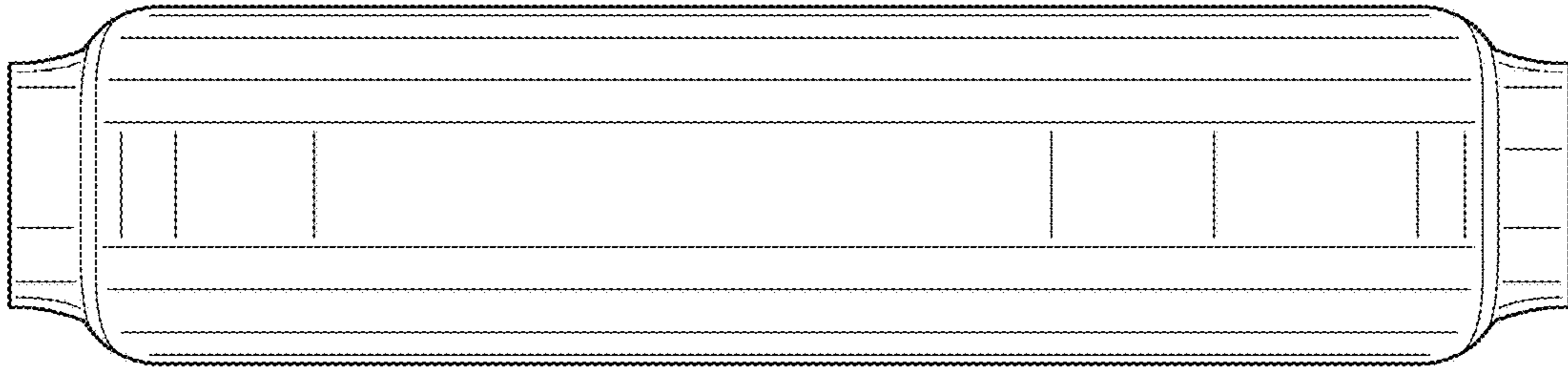

FIG.6

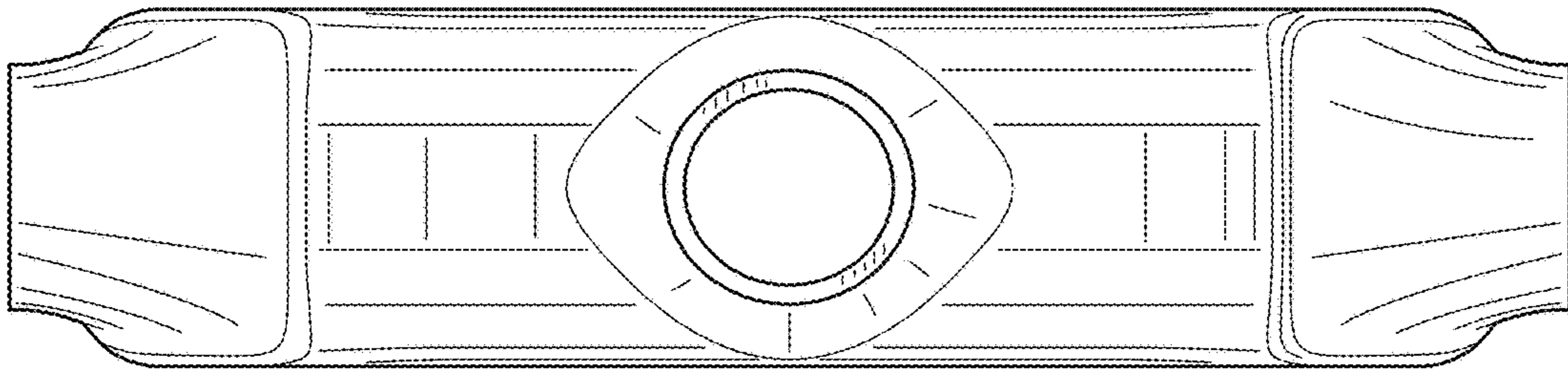

FIG.7