



US00D819402S

(12) **United States Design Patent**
Silsby et al.

(10) **Patent No.:** **US D819,402 S**
(45) **Date of Patent:** **** Jun. 5, 2018**

(54) **BEVERAGE CONTAINER**

(71) Applicant: **Pacific Market International, LLC**,
Seattle, WA (US)

(72) Inventors: **Jacob D. Silsby**, Seattle, WA (US);
Evan Michael Choltco-Devlin,
Ellensburg, WA (US)

(73) Assignee: **Pacific Market International, LLC**,
Seattle, WA (US)

(**) Term: **15 Years**

(21) Appl. No.: **29/596,136**

(22) Filed: **Mar. 6, 2017**

(51) **LOC (11) Cl.** **07-01**

(52) **U.S. Cl.**
USPC **D7/510; D7/511; D7/536; D7/608**

(58) **Field of Classification Search**
USPC **D7/507, 509, 510, 511, 523, 529, 530,**
D7/531, 532, 533, 536, 300.1, 300.2, 608,
(Continued)

(56) **References Cited**

U.S. PATENT DOCUMENTS

D295,355 S * 4/1988 Leung D7/608
D321,628 S * 11/1991 Kobayashi D7/608
(Continued)

OTHER PUBLICATIONS

“Hydroflask Wide Mouth Bottle,” 1 page, Hydroflask product
publicly disclosed prior to Mar. 6, 2017.
(Continued)

Primary Examiner — Marianne Pandozzi

Assistant Examiner — Jae Liang

(74) *Attorney, Agent, or Firm* — George C. Rondeau, Jr.;
Davis Wright Tremaine LLP

(57) **CLAIM**

The ornamental design for a beverage container, as shown
and described.

DESCRIPTION

FIG. 1 is a top perspective view of a first embodiment of a
beverage container showing our new design;
FIG. 2 is a bottom perspective view thereof.
FIG. 3 is a front elevational view thereof.
FIG. 4 is a right side elevational view thereof.
FIG. 5 is a left side elevational view thereof.
FIG. 6 is a rear elevational view thereof.
FIG. 7 is a top plan view thereof.
FIG. 8 is a bottom plan view thereof.
FIG. 9 is a top perspective view of a second embodiment
thereof.
FIG. 10 is a bottom perspective view thereof.
FIG. 11 is a front elevational view thereof.
FIG. 12 is a right side elevational view thereof.
FIG. 13 is a left side elevational view thereof.
FIG. 14 is a rear elevational view thereof.
FIG. 15 is a top plan view thereof.
FIG. 16 is a bottom plan view thereof.
FIG. 17 is a top perspective view of a third embodiment
thereof.
FIG. 18 is a bottom perspective view thereof.
FIG. 19 is a front elevational view thereof.
FIG. 20 is a right side elevational view thereof.
FIG. 21 is a left side elevational view thereof.
FIG. 22 is a rear elevational view thereof.
FIG. 23 is a top plan view thereof.
FIG. 24 is a bottom plan view thereof.
FIG. 25 is a top perspective view of a fourth embodiment
thereof.
FIG. 26 is a bottom perspective view thereof.
FIG. 27 is a front elevational view thereof.
FIG. 28 is a right side elevational view thereof.
FIG. 29 is a left side elevational view thereof.
FIG. 30 is a rear elevational view thereof.
FIG. 31 is a top plan view thereof.
FIG. 32 is a bottom plan view thereof.

(Continued)

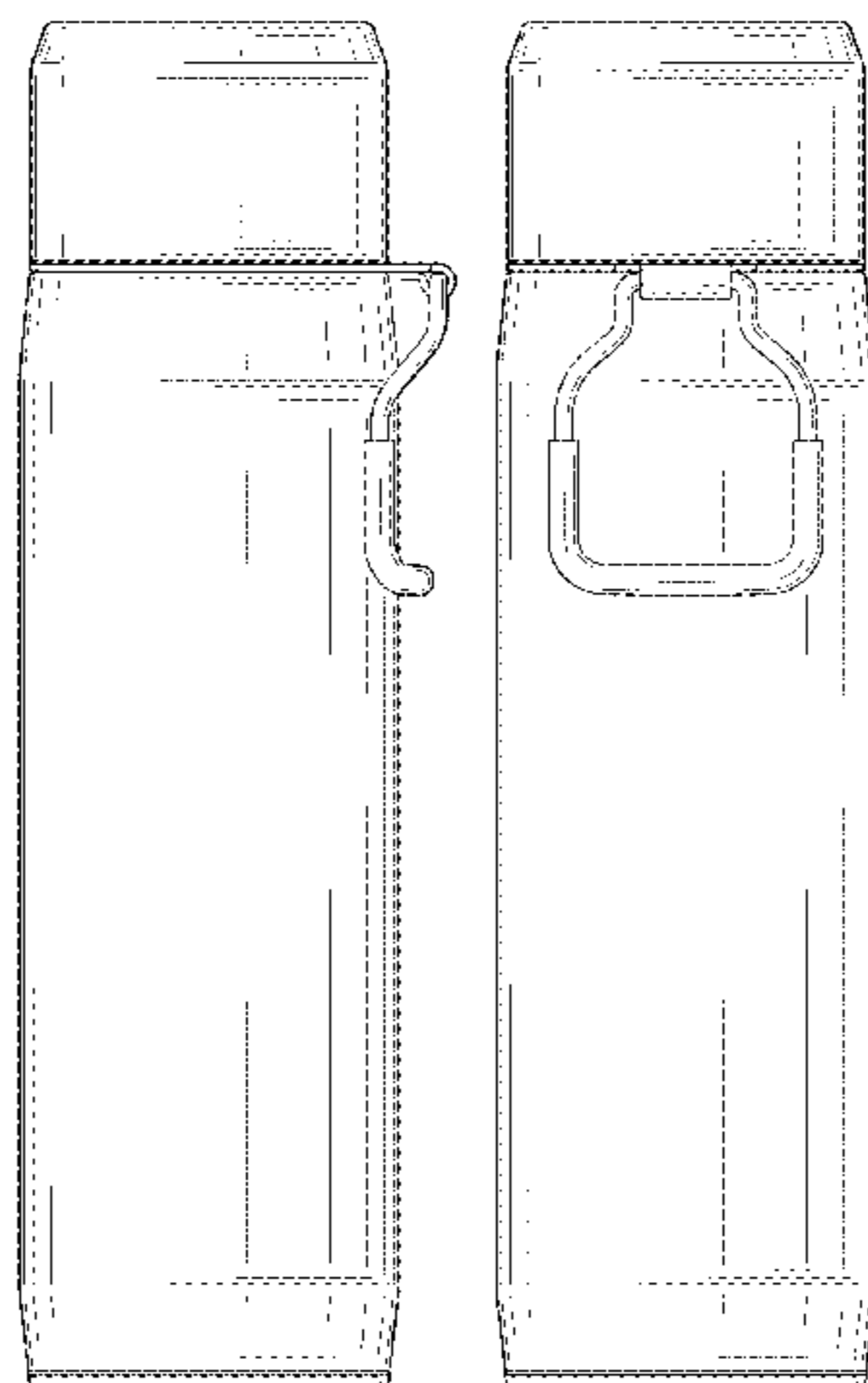

FIG. 33 is a top perspective view of a fifth embodiment thereof;
 FIG. 34 is a bottom perspective view thereof;
 FIG. 35 is a front elevational view thereof;
 FIG. 36 is a right side elevational view thereof;
 FIG. 37 is a left side elevational view thereof;
 FIG. 38 is a rear elevational view thereof;
 FIG. 39 is a top plan view thereof;
 FIG. 40 is a bottom plan view thereof;
 FIG. 41 is a top perspective view of a sixth embodiment thereof;
 FIG. 42 is a bottom perspective view thereof;
 FIG. 43 is a front elevational view thereof;
 FIG. 44 is a right side elevational view thereof;
 FIG. 45 is a left side elevational view thereof;
 FIG. 46 is a rear elevational view thereof;
 FIG. 47 is a top plan view thereof;
 FIG. 48 is a bottom plan view thereof;
 FIG. 49 is a top perspective view of a seventh embodiment thereof;
 FIG. 50 is a bottom perspective view thereof;
 FIG. 51 is a front elevational view thereof;
 FIG. 52 is a right side elevational view thereof;
 FIG. 53 is a left side elevational view thereof;
 FIG. 54 is a rear elevational view thereof;
 FIG. 55 is a top plan view thereof;
 FIG. 56 is a bottom plan view thereof;
 FIG. 57 is a top perspective view of an eighth embodiment thereof;
 FIG. 58 is a bottom perspective view thereof;
 FIG. 59 is a front elevational view thereof;
 FIG. 60 is a right side elevational view thereof;
 FIG. 61 is a left side elevational view thereof;
 FIG. 62 is a rear elevational view thereof;
 FIG. 63 is a top plan view thereof; and,

FIG. 64 is a bottom plan view thereof.
 The broken lines in the drawings depict portions of the beverage container that form no part of the claimed design.

1 Claim, 56 Drawing Sheets

(58) **Field of Classification Search**
 USPC D7/387, 393, 213, 396.6; 220/592.16,
 220/592.17, 495.03; D9/503, 504
 CPC A47G 19/22; A47G 19/2205; A47G 19/02;
 A47G 19/00; A47J 43/27; A47J 41/02
 See application file for complete search history.

(56) **References Cited**

U.S. PATENT DOCUMENTS

D391,122	S	*	2/1998	Wu	D6/678.4
D505,257	S	*	5/2005	DiMarchi	D3/208
D514,392	S	*	2/2006	Bruns	B62B 3/00 D7/606
D658,450	S	*	5/2012	Ying	D7/608
D660,081	S	*	5/2012	Gilbert	D7/396.2
D690,558	S	*	10/2013	Lane	D7/510
D699,516	S	*	2/2014	Kim	D7/510
D724,601	S	*	3/2015	Hsieh	D14/480.3
D741,113	S	*	10/2015	Miros	D7/608
D753,442	S	*	4/2016	Weermink	D7/507
D772,652	S	*	11/2016	Yao	D7/510
D775,893	S	*	1/2017	Buckley	D7/510
D778,677	S	*	2/2017	Boroski	D7/510

OTHER PUBLICATIONS

“Yeti Rambler Bottles,” 1 page, Yeti product publicly disclosed prior to Mar. 6, 2017.

* cited by examiner

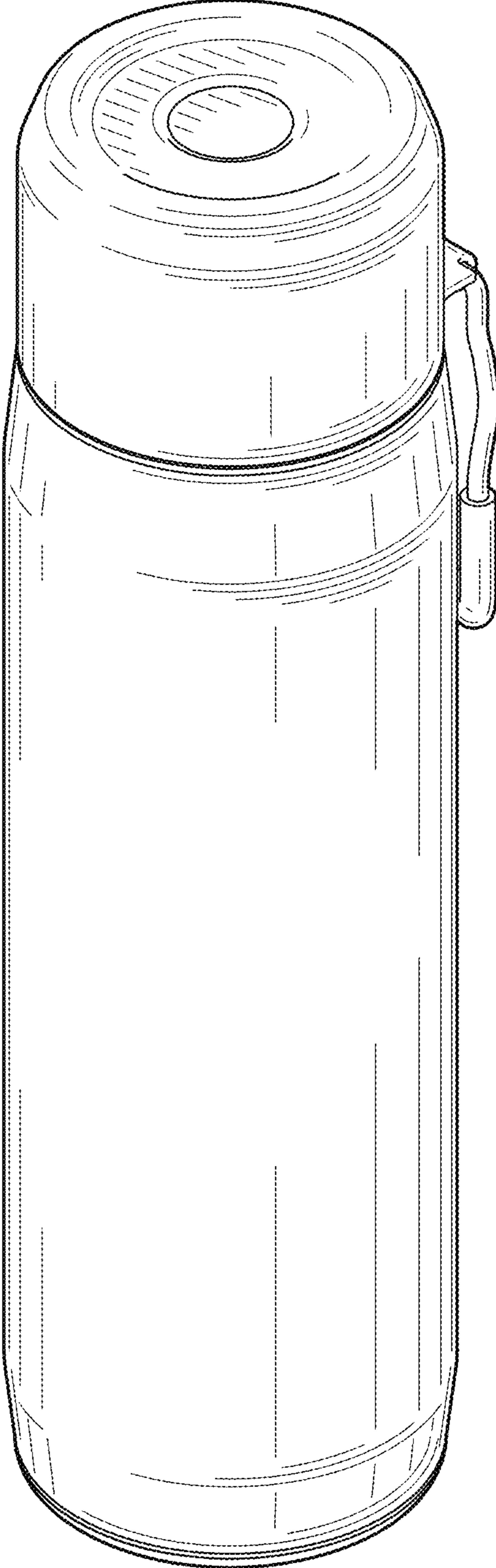

FIG. 1

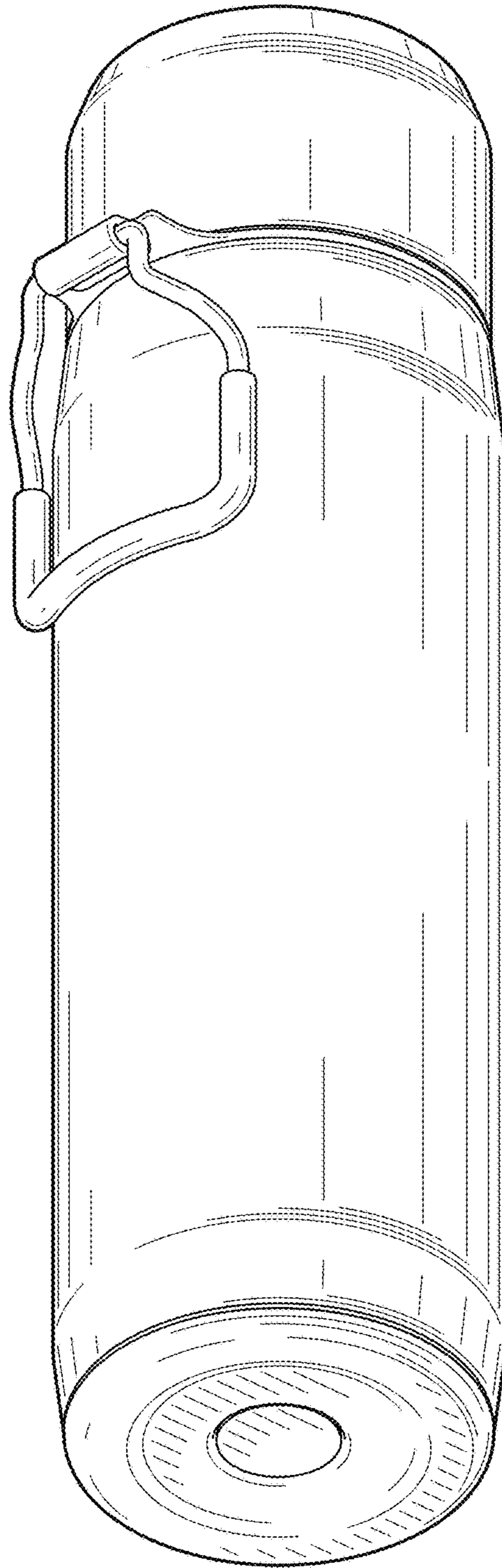

FIG. 2

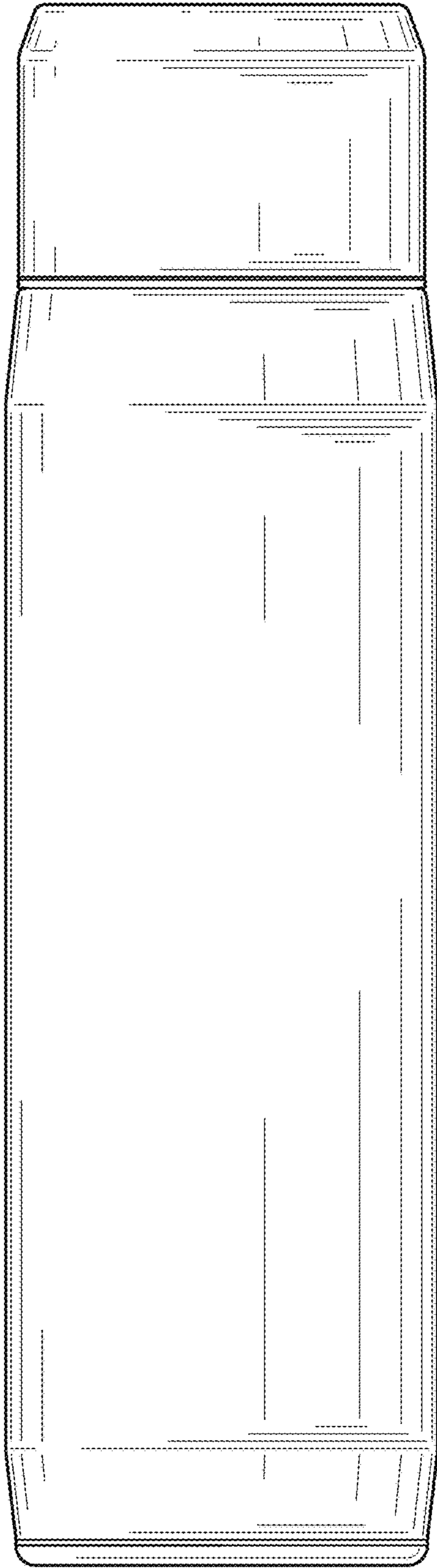

FIG. 3

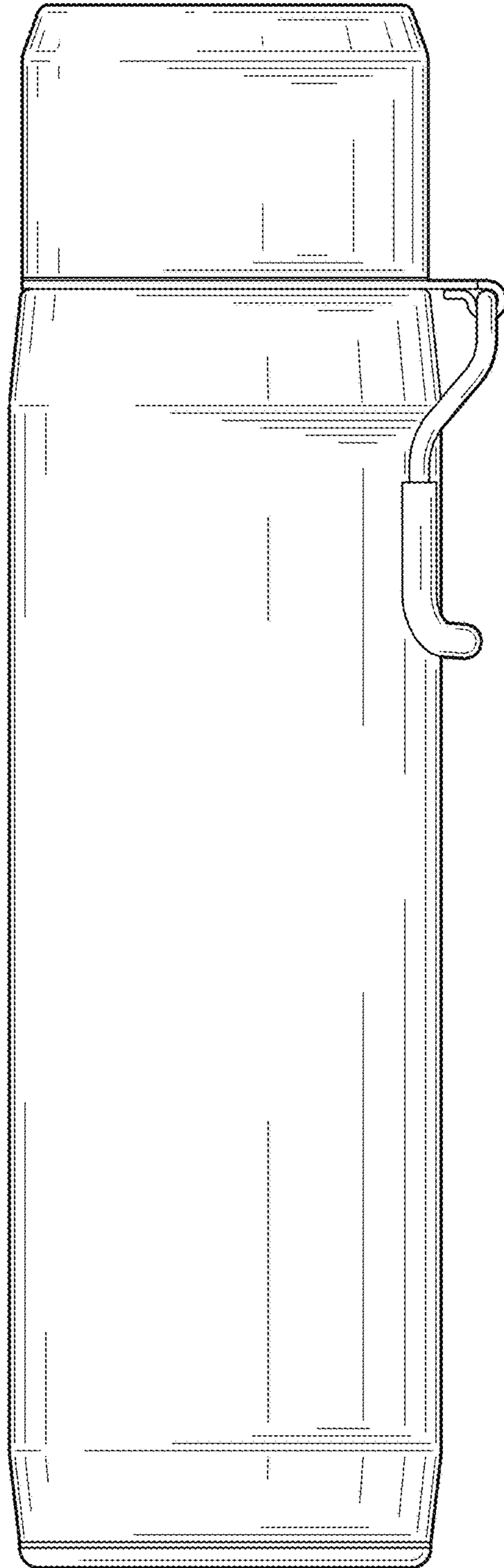

FIG. 4

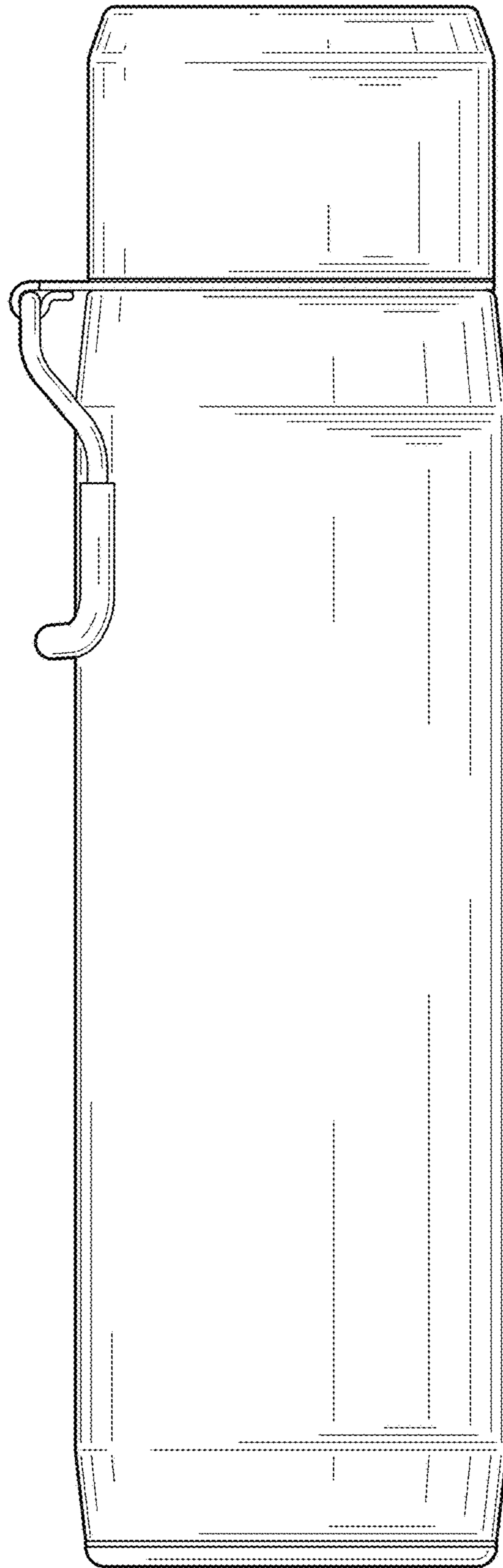

FIG. 5

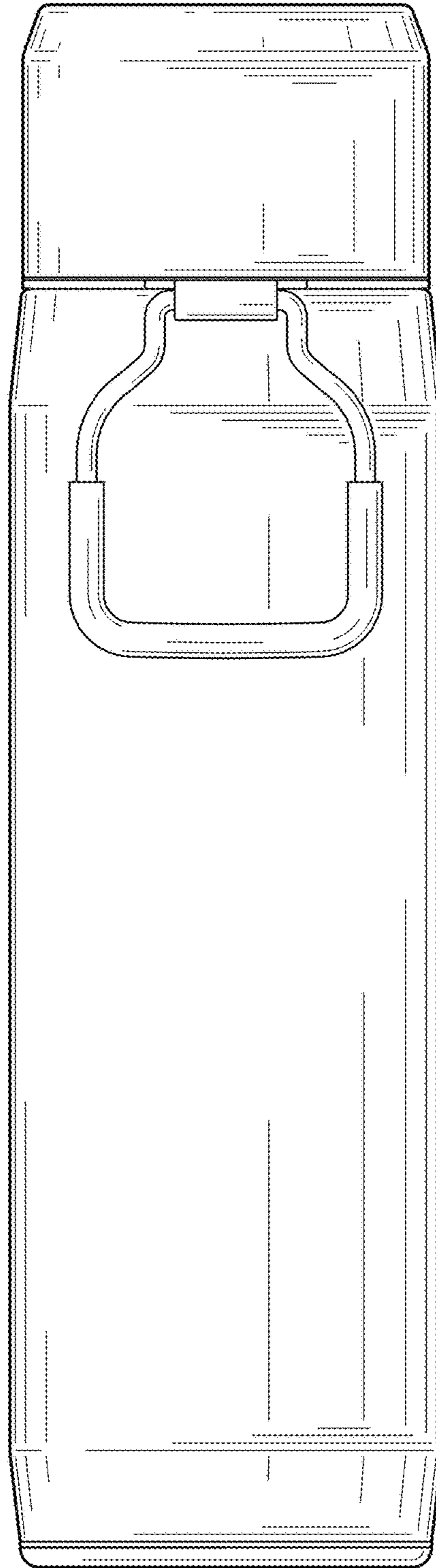

FIG. 6

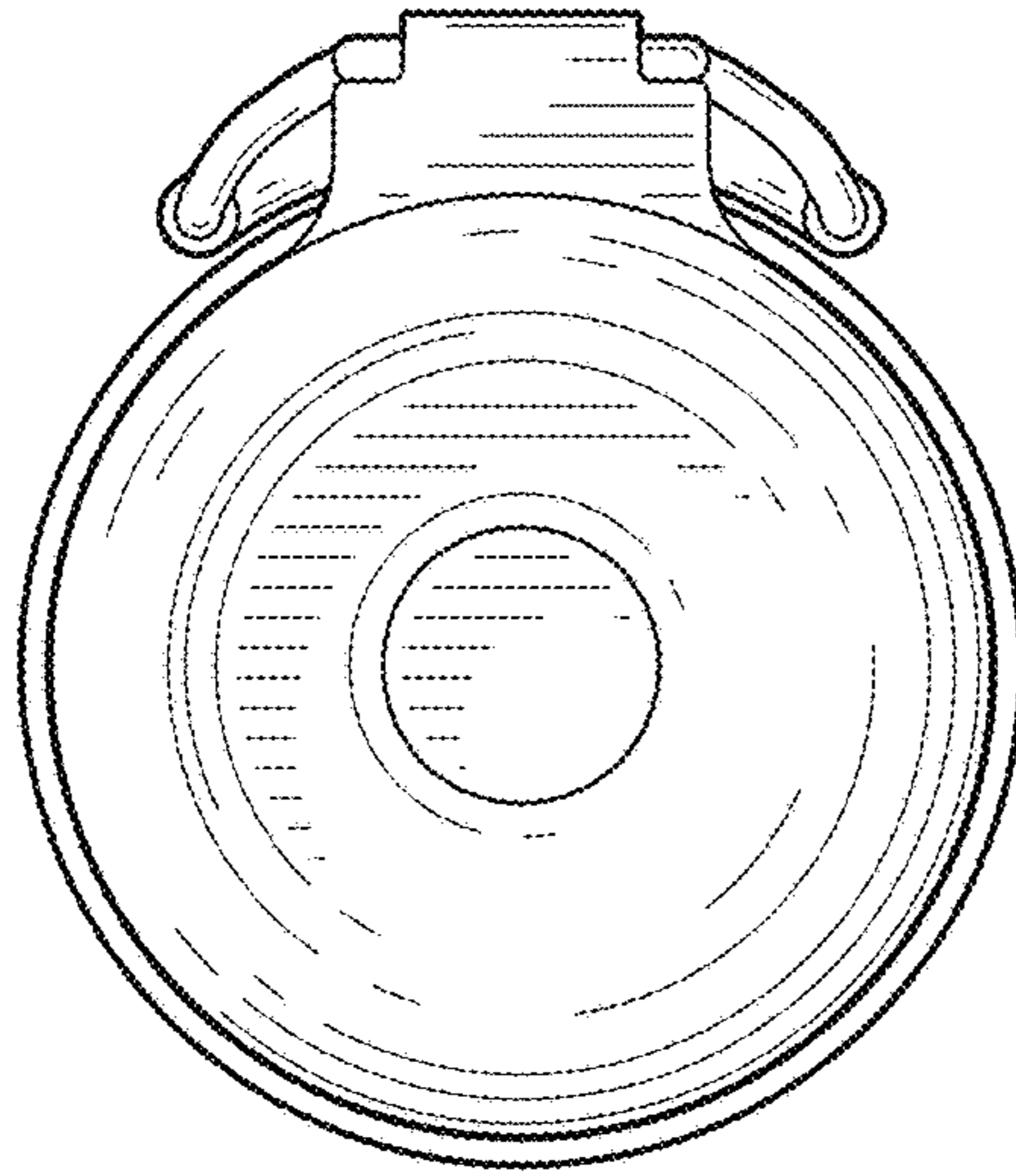

FIG. 7

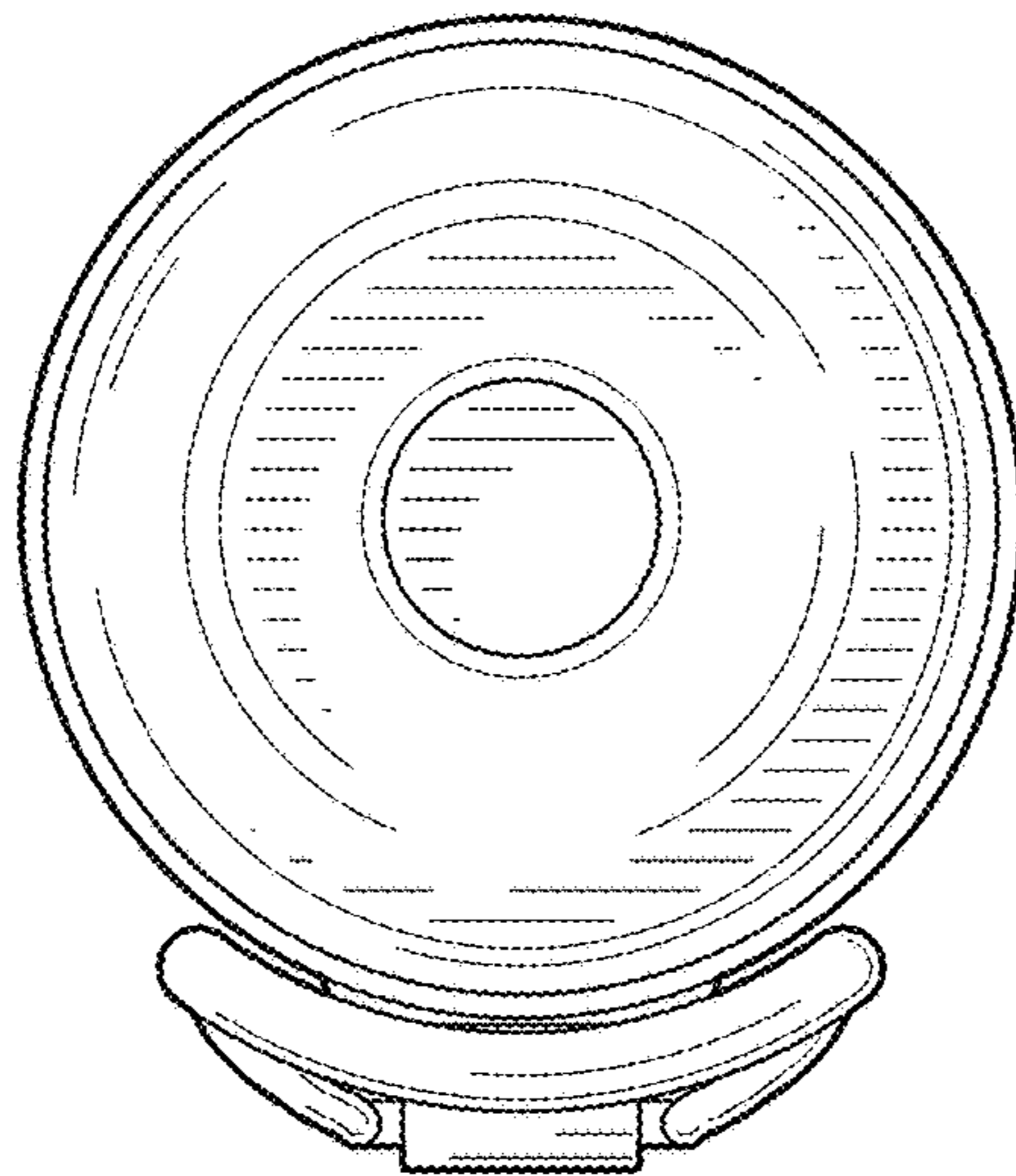

FIG. 8

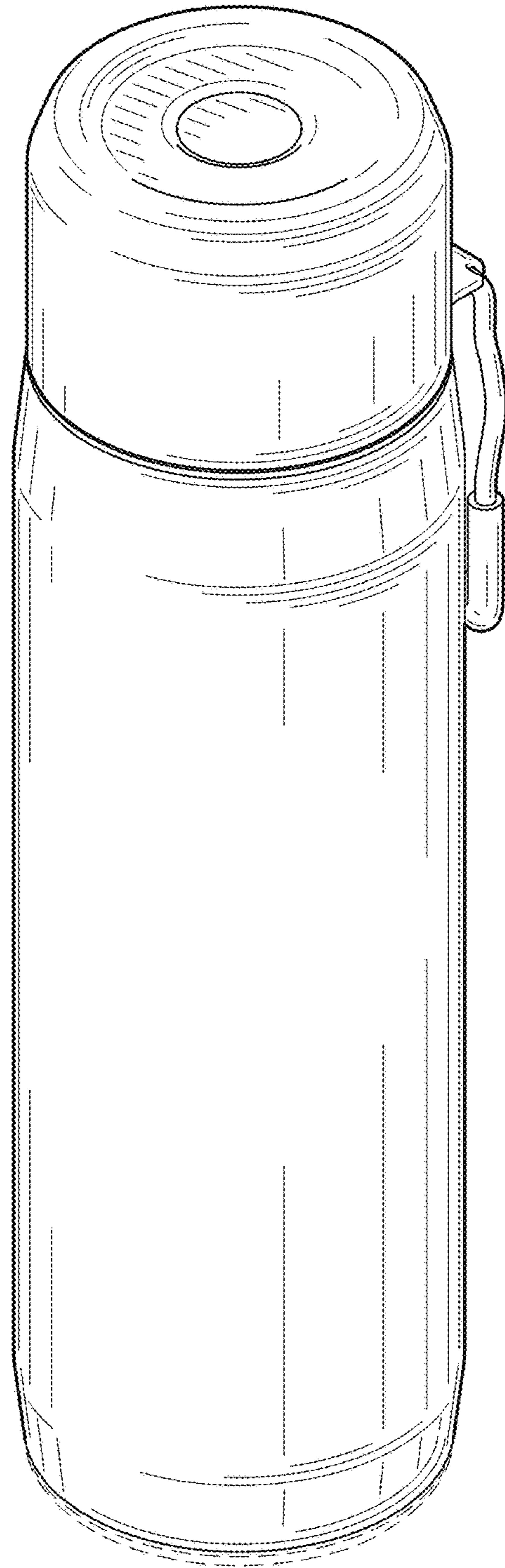

FIG. 9

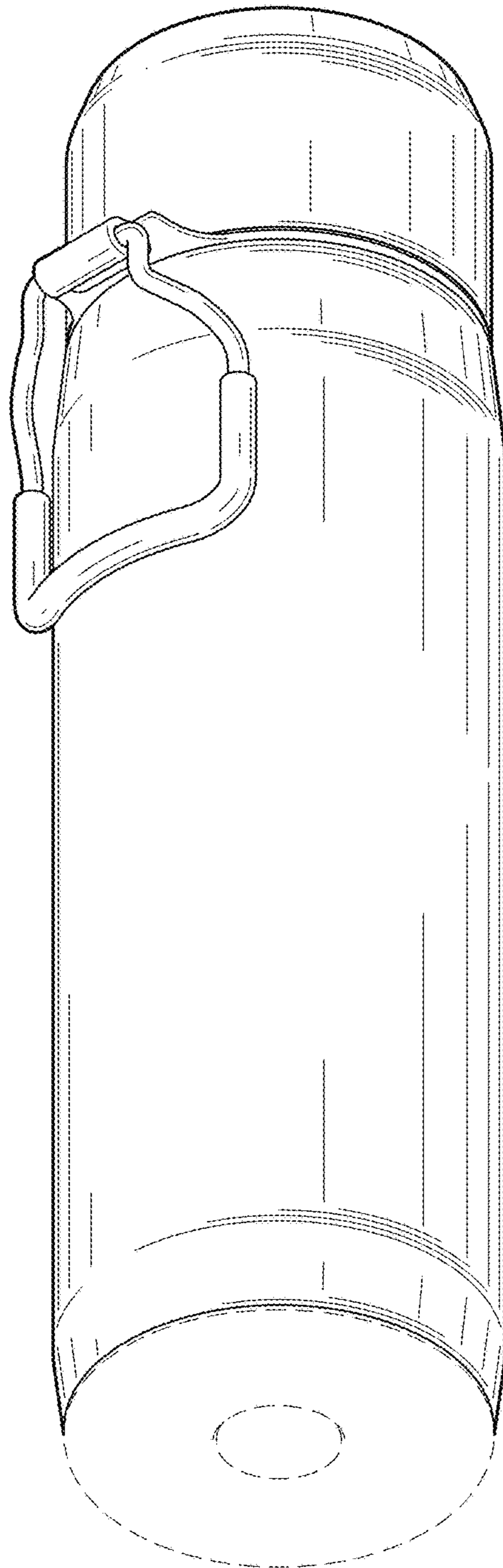

FIG. 10

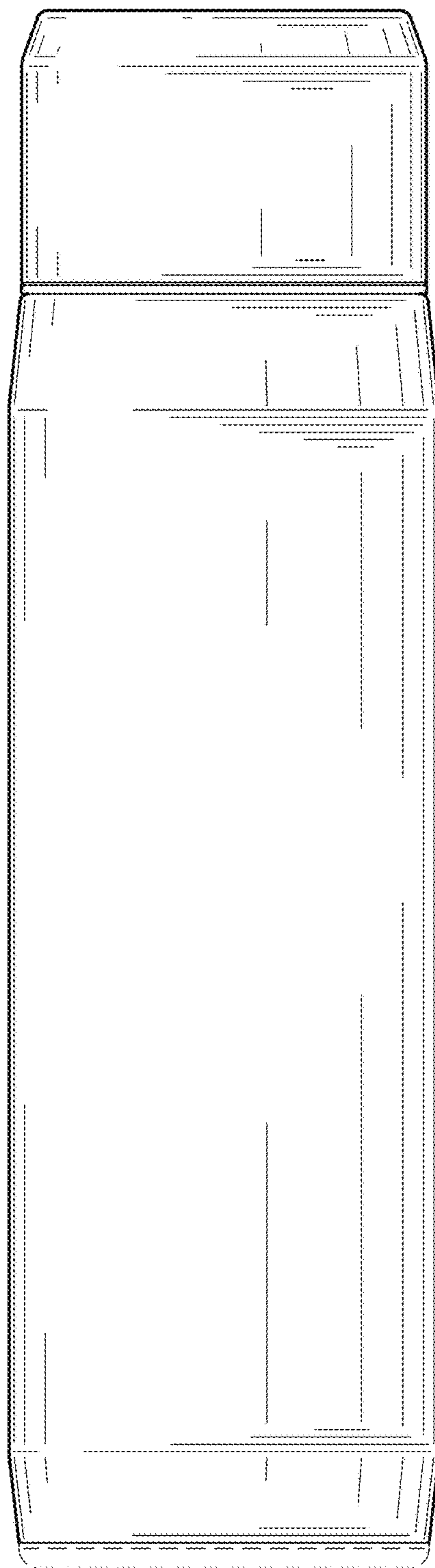

FIG. 11

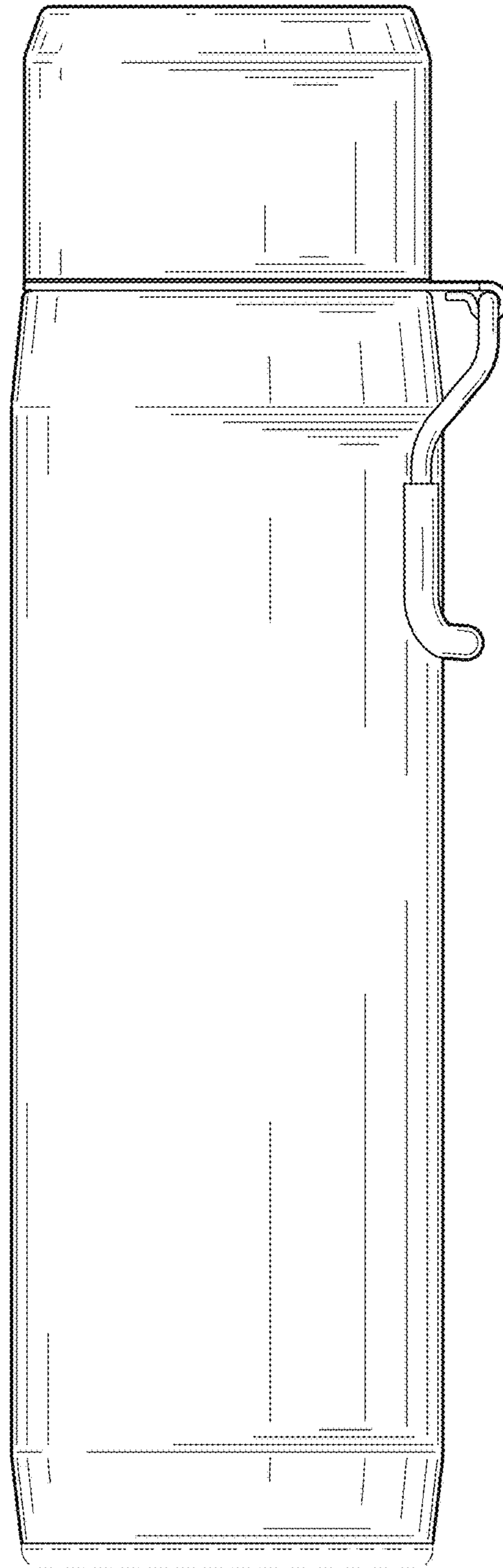

FIG. 12

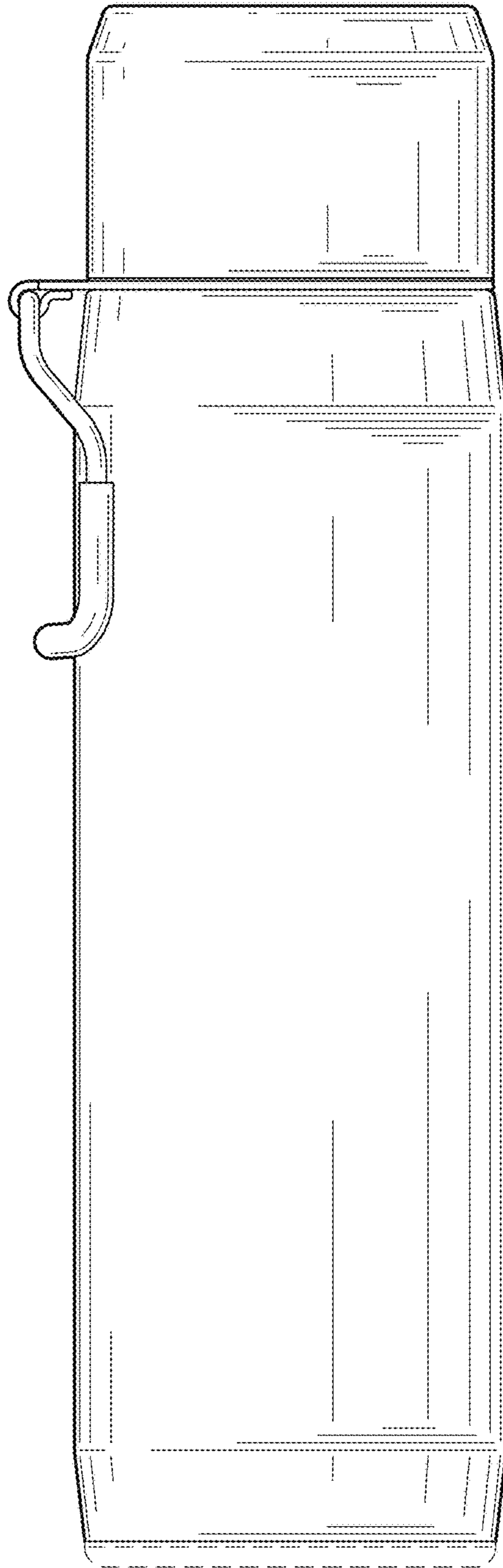

FIG. 13

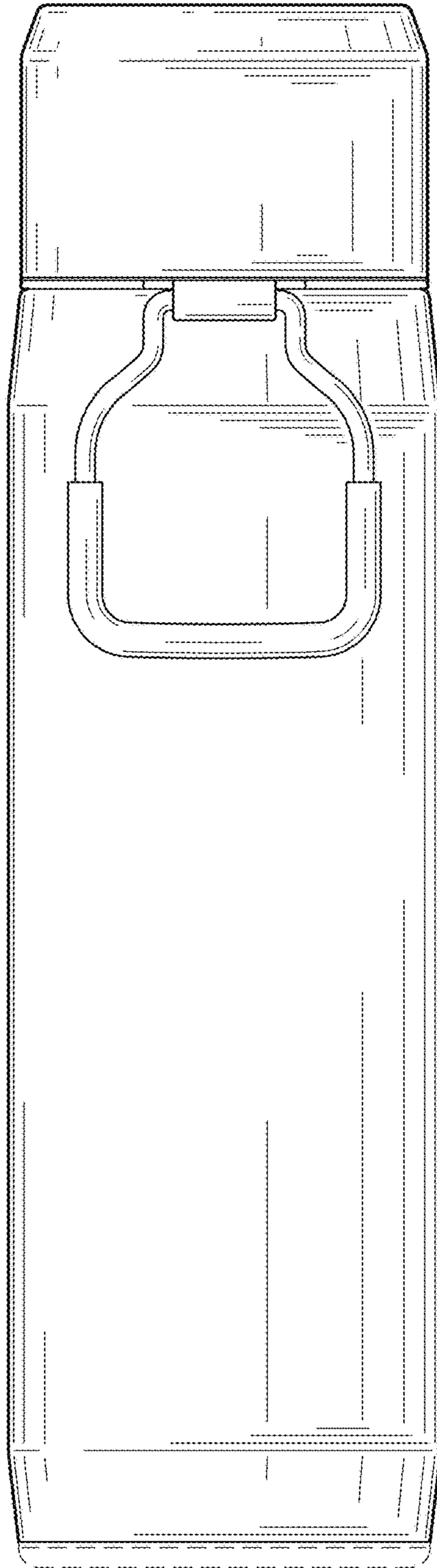

FIG. 14

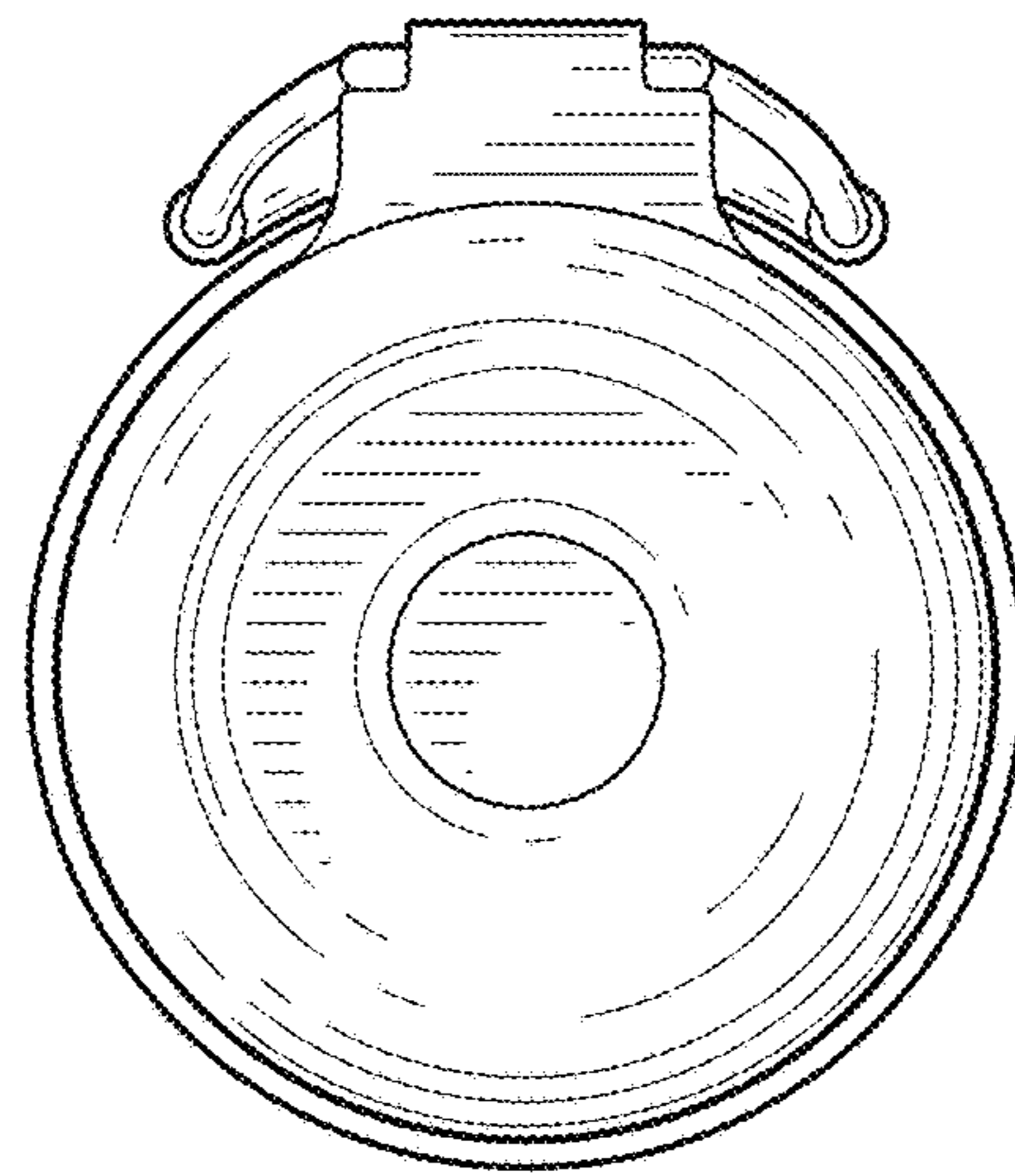

FIG. 15

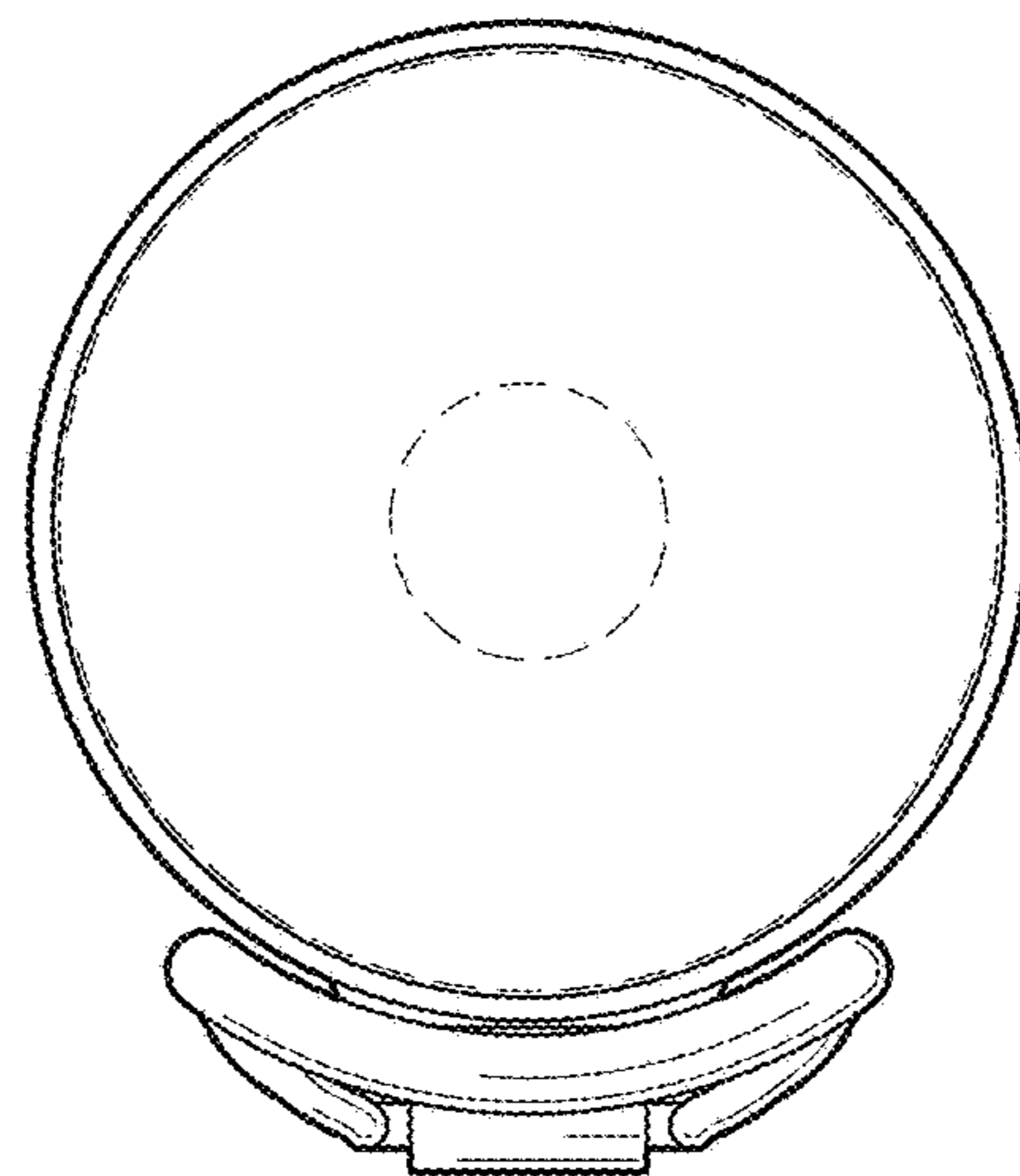

FIG. 16

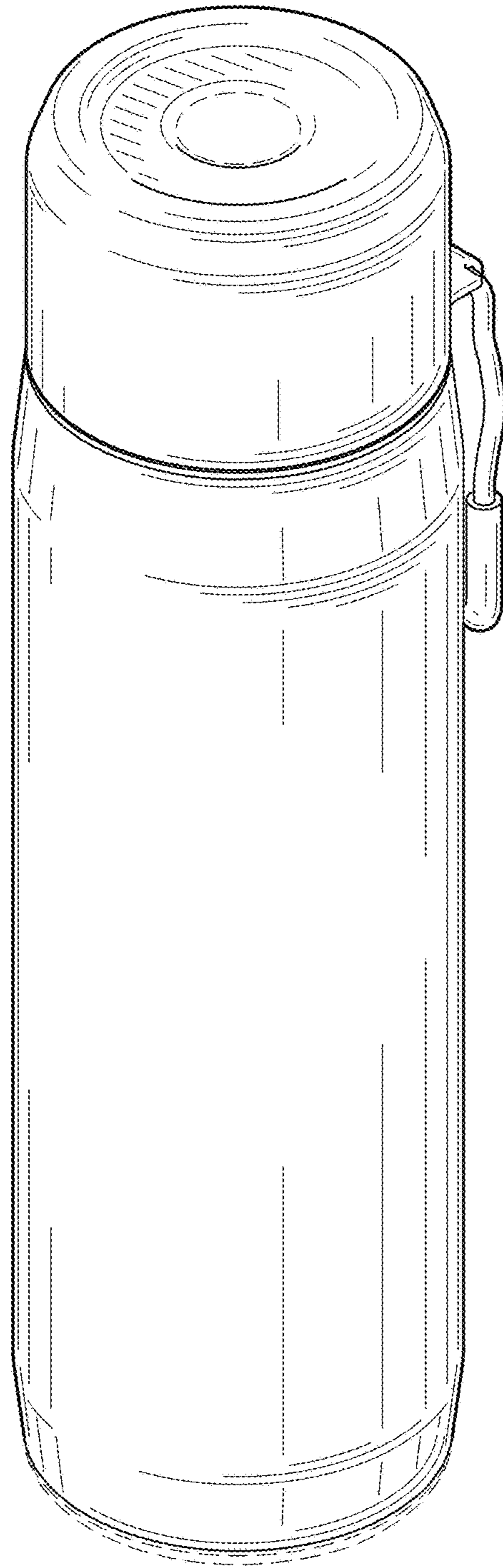

FIG. 17

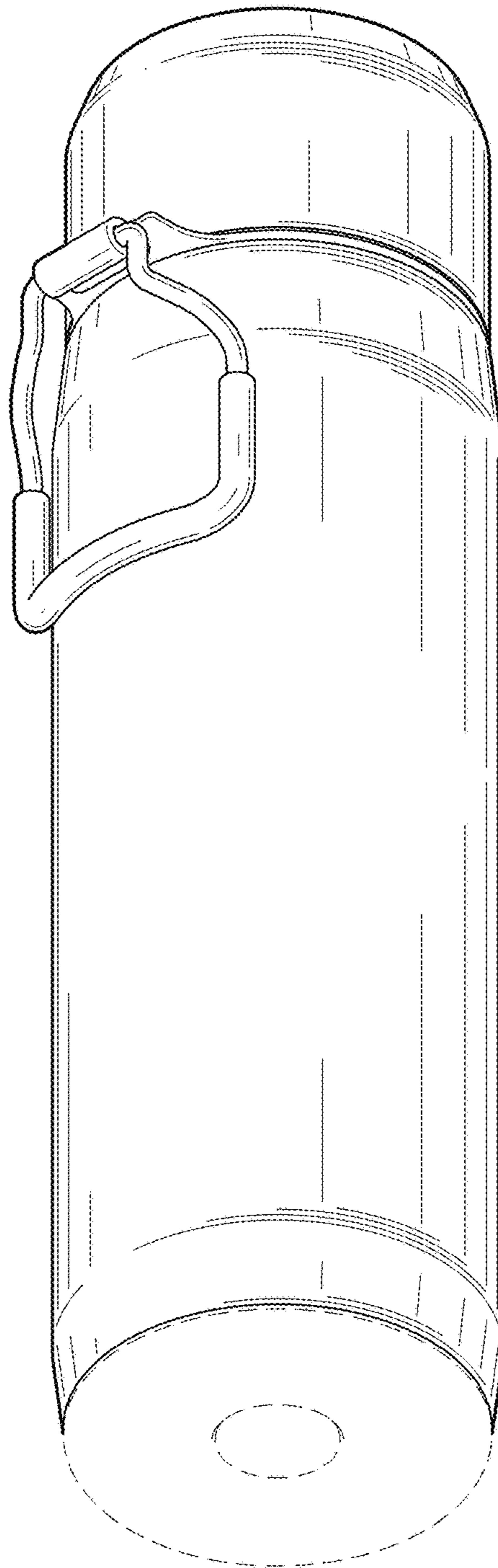

FIG. 18

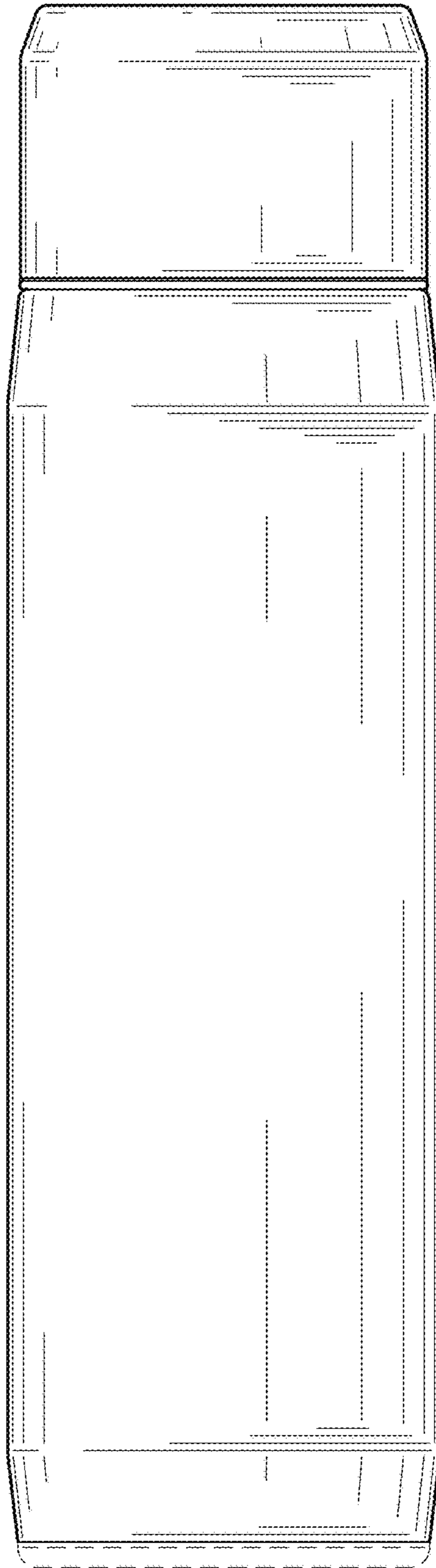

FIG. 19

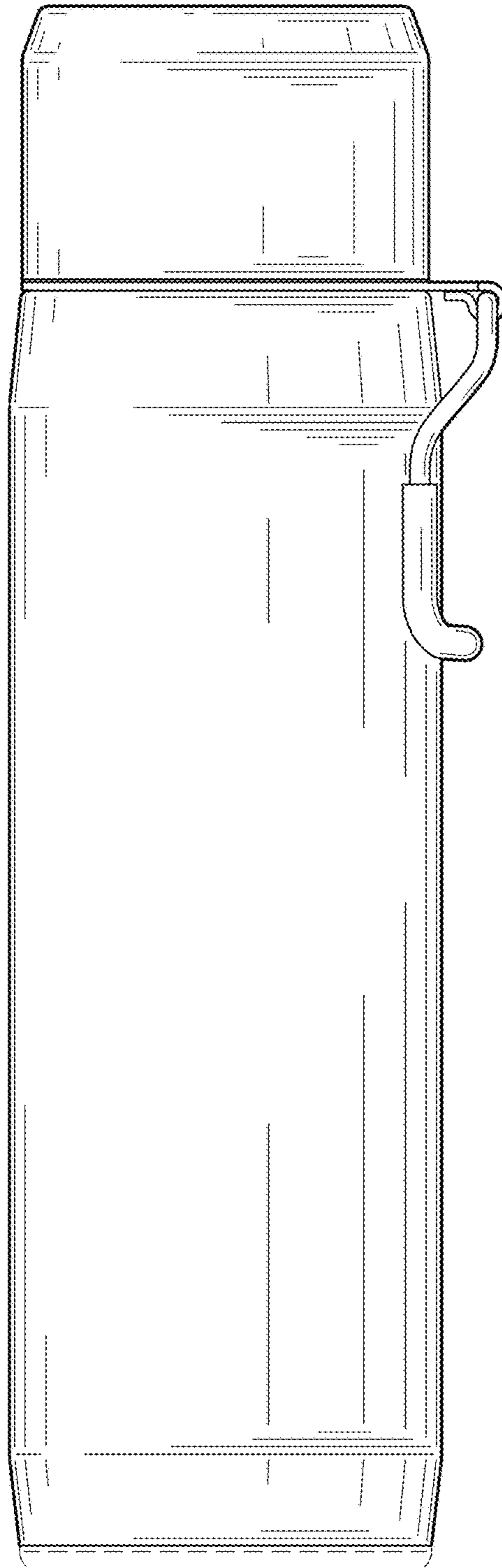

FIG. 20

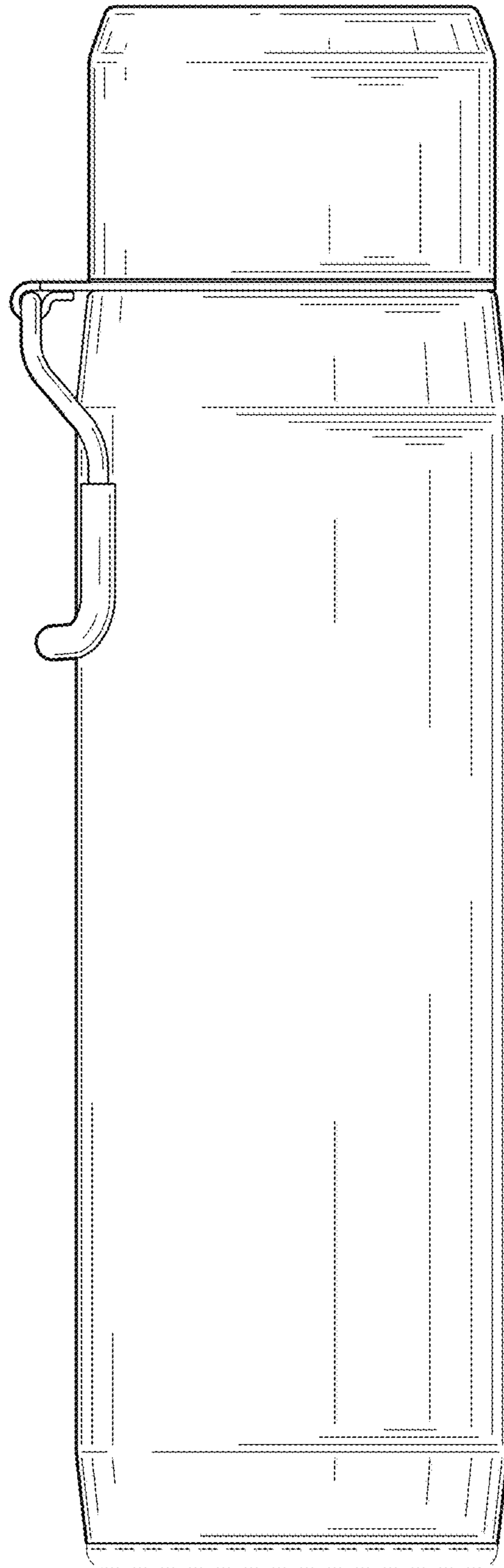

FIG. 21

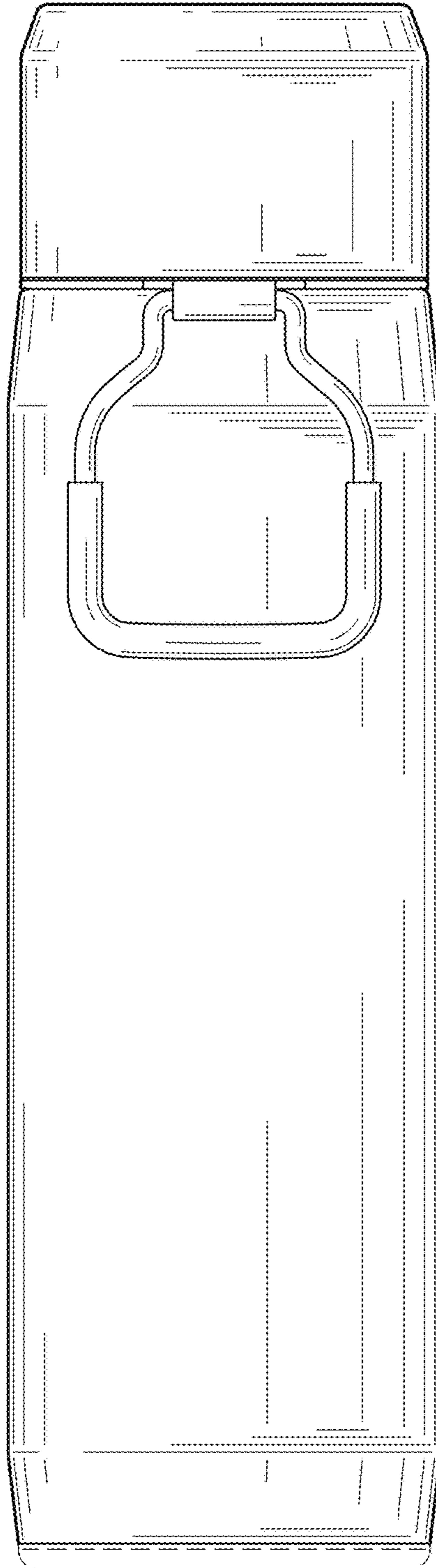

FIG. 22

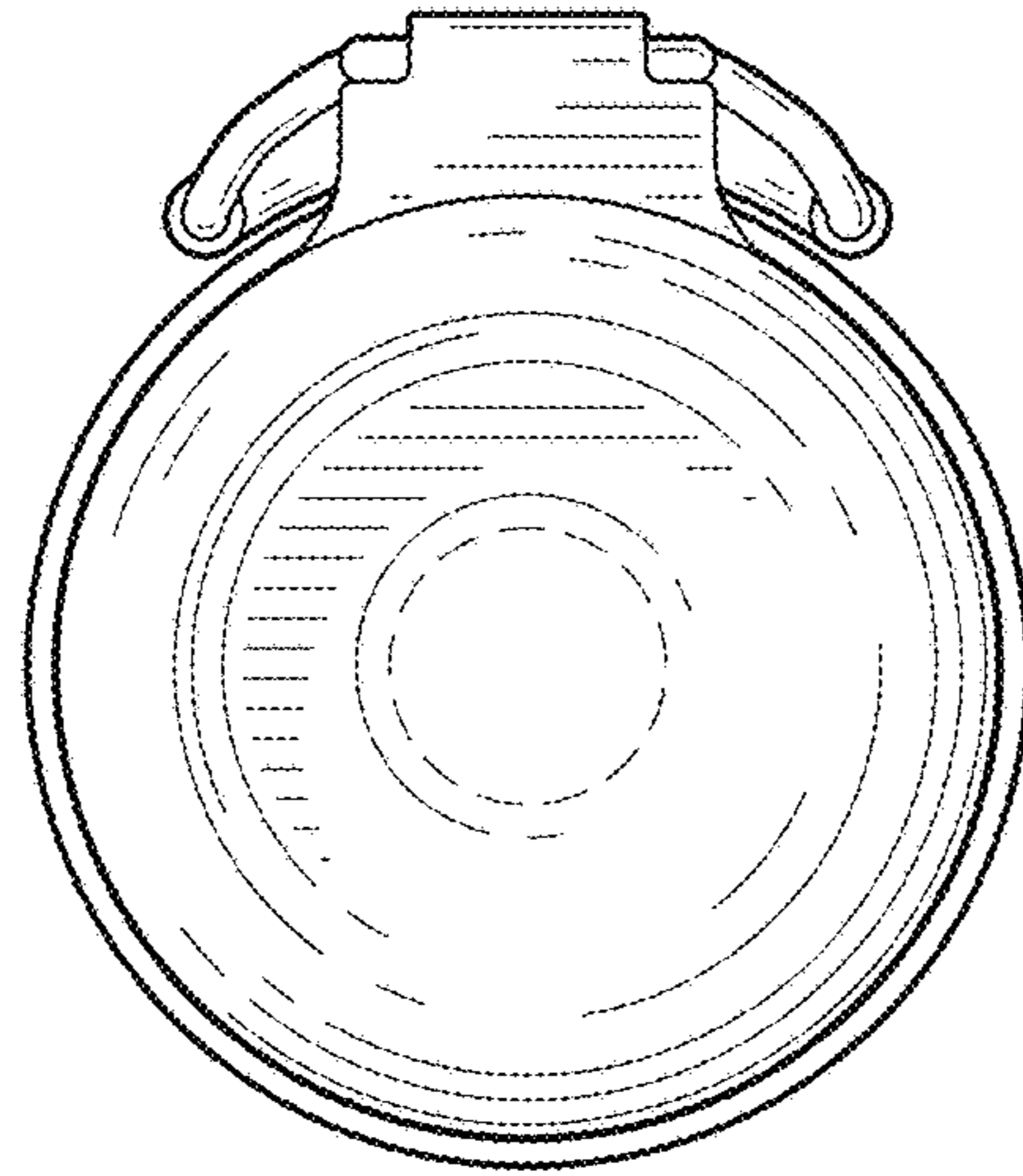

FIG. 23

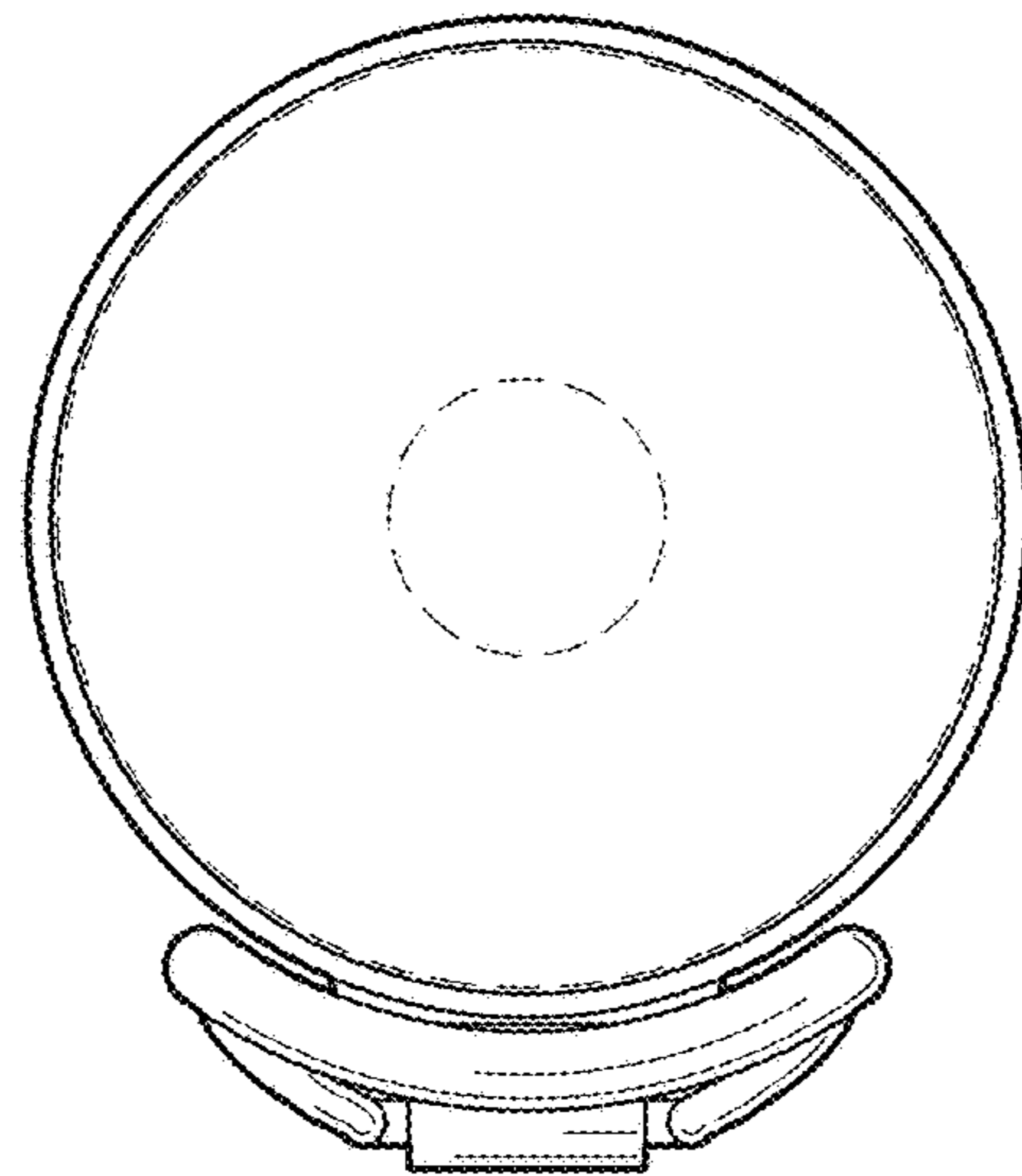

FIG. 24

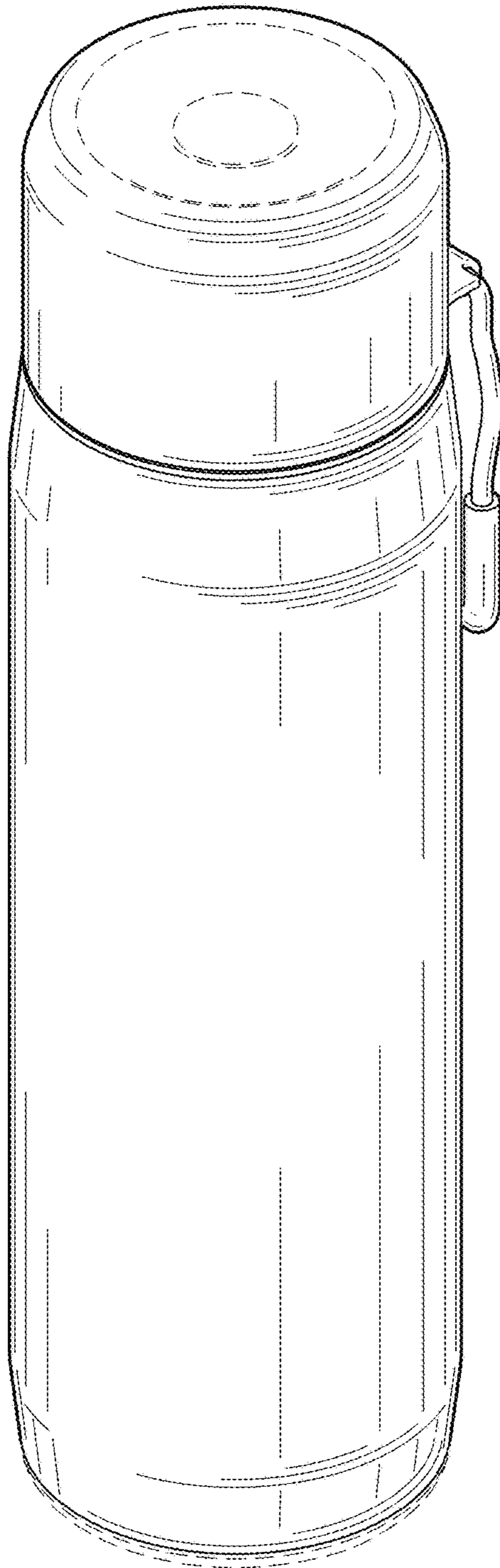

FIG. 25

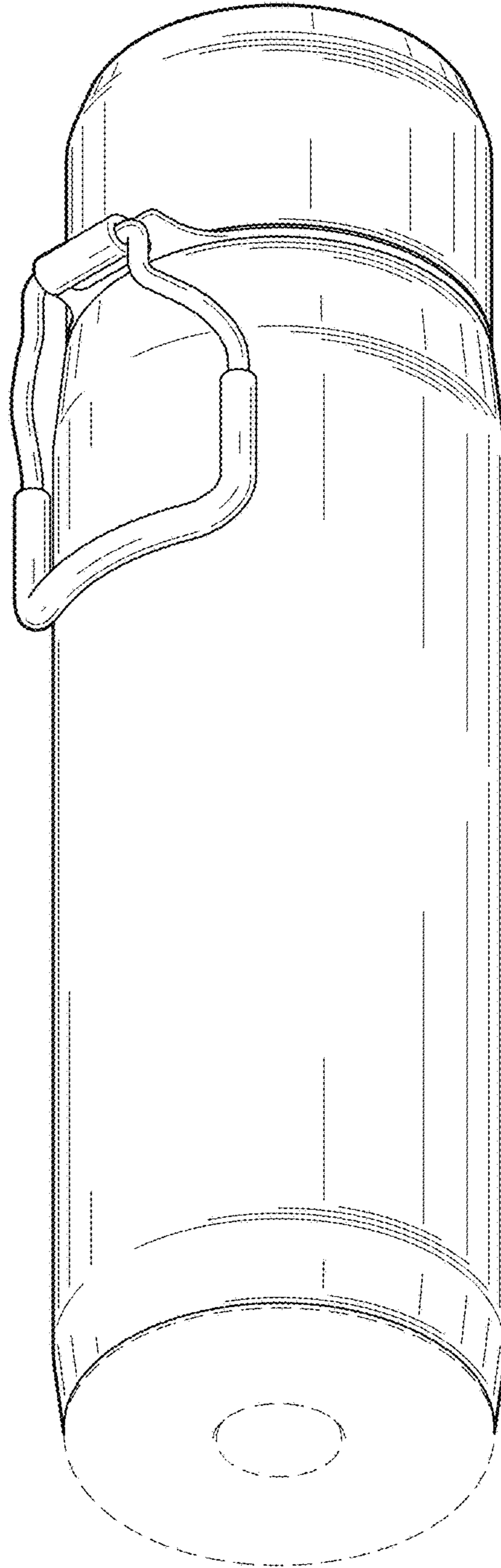

FIG. 26

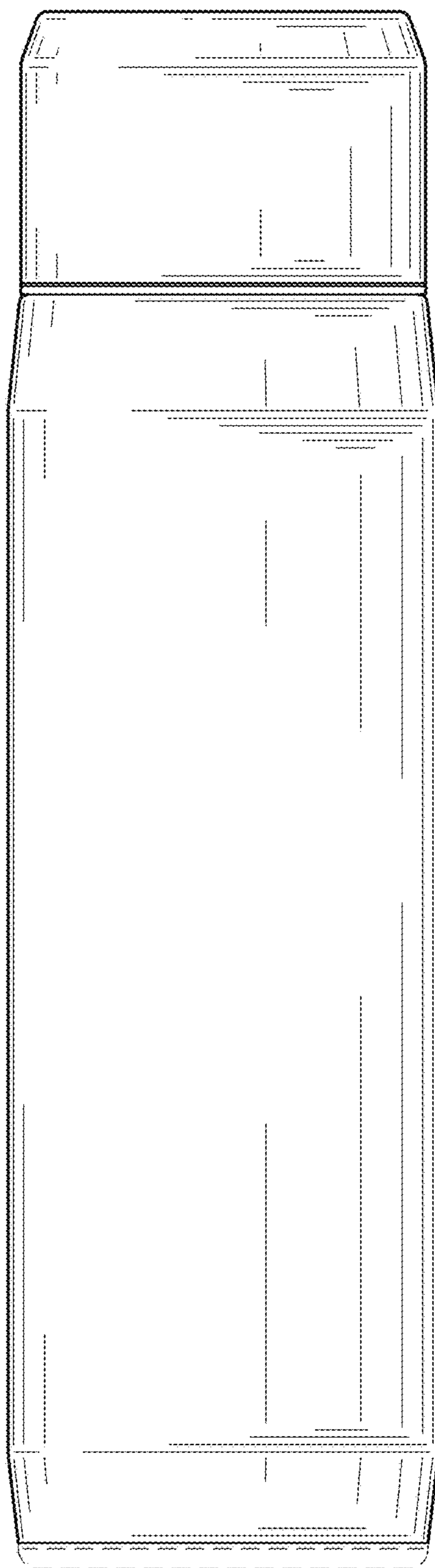

FIG. 27

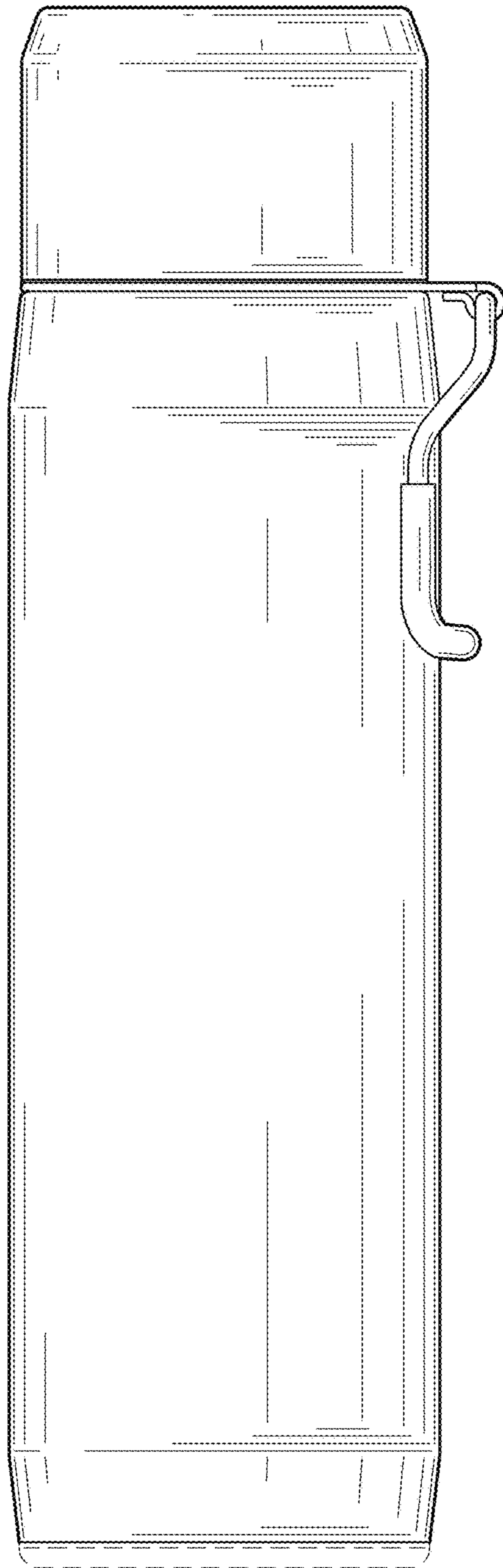

FIG. 28

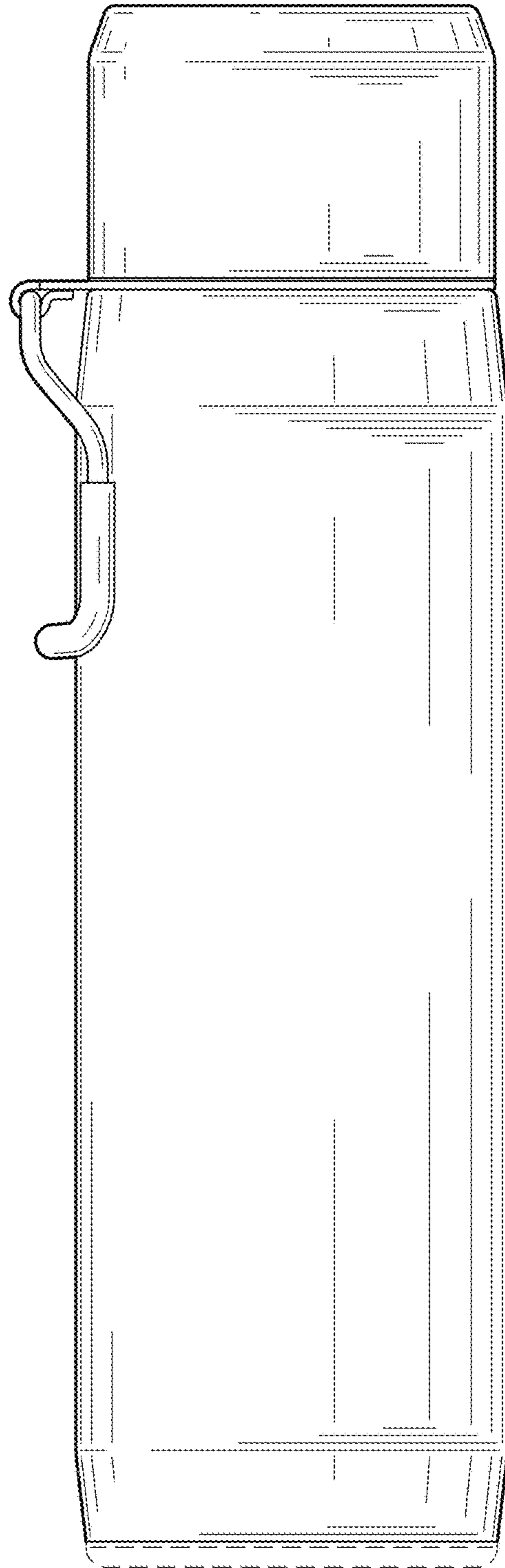

FIG. 29

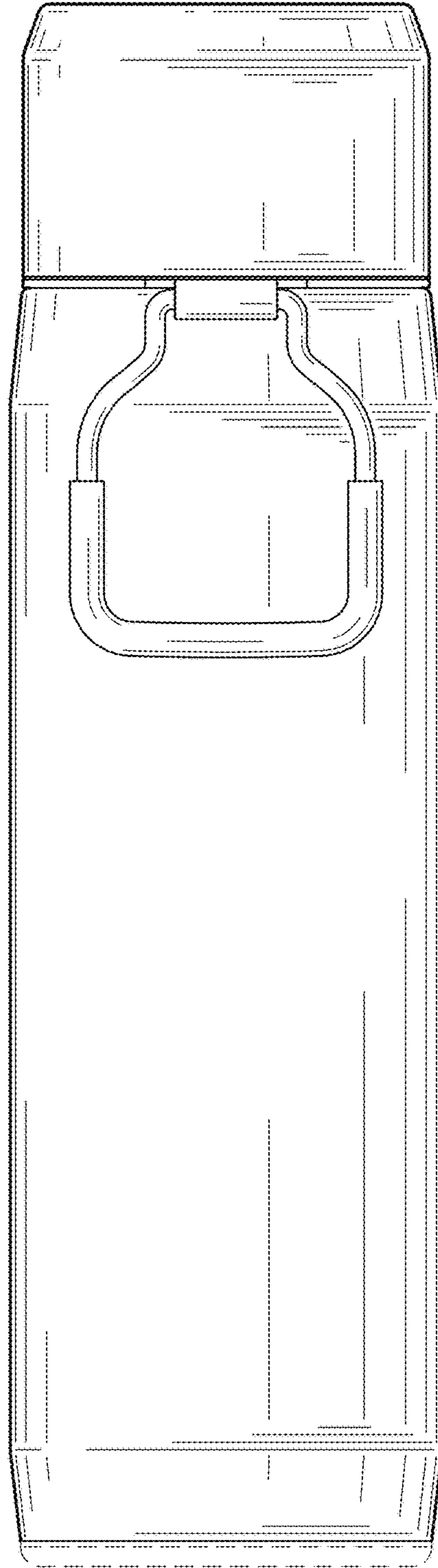

FIG. 30

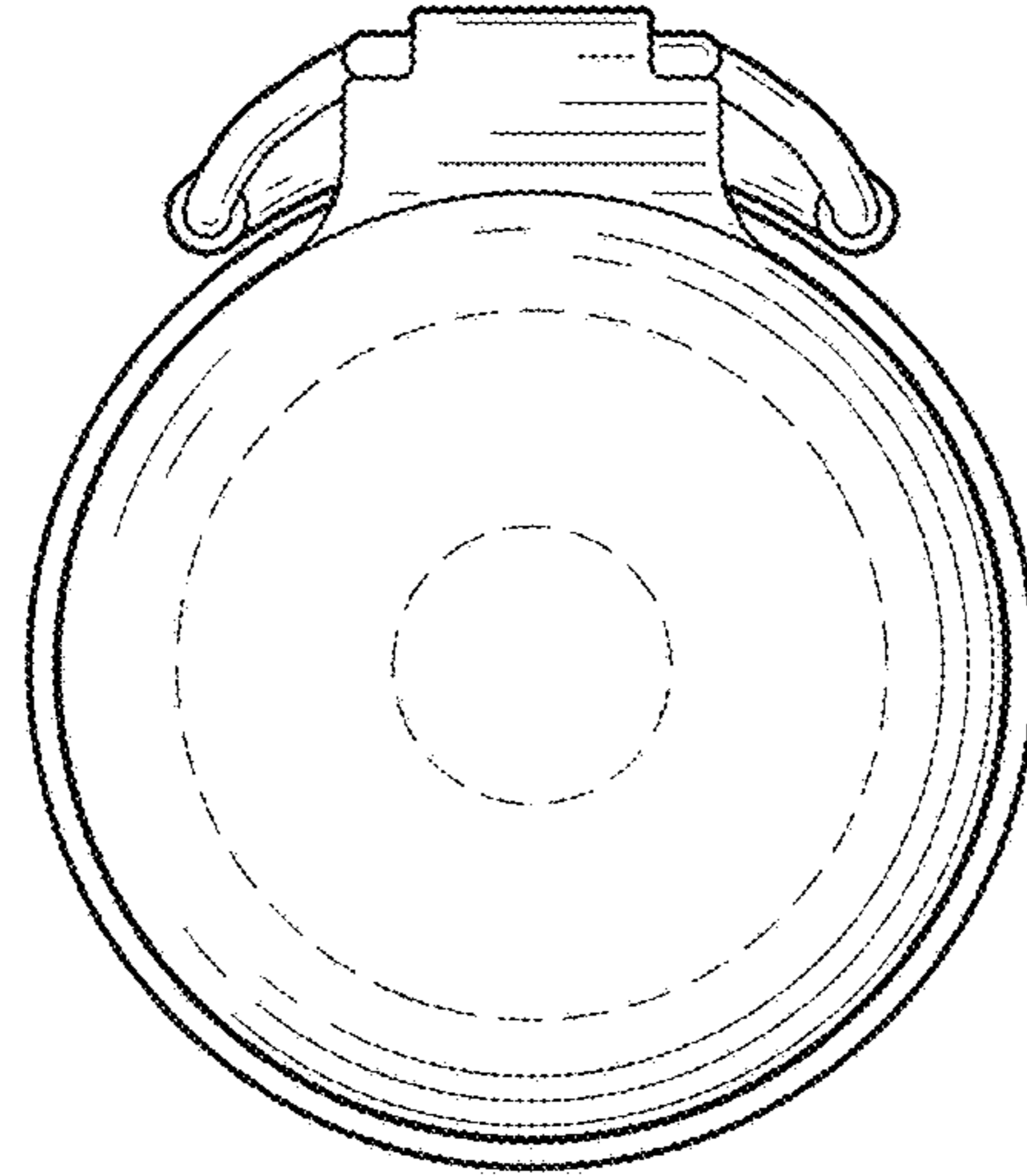

FIG. 31

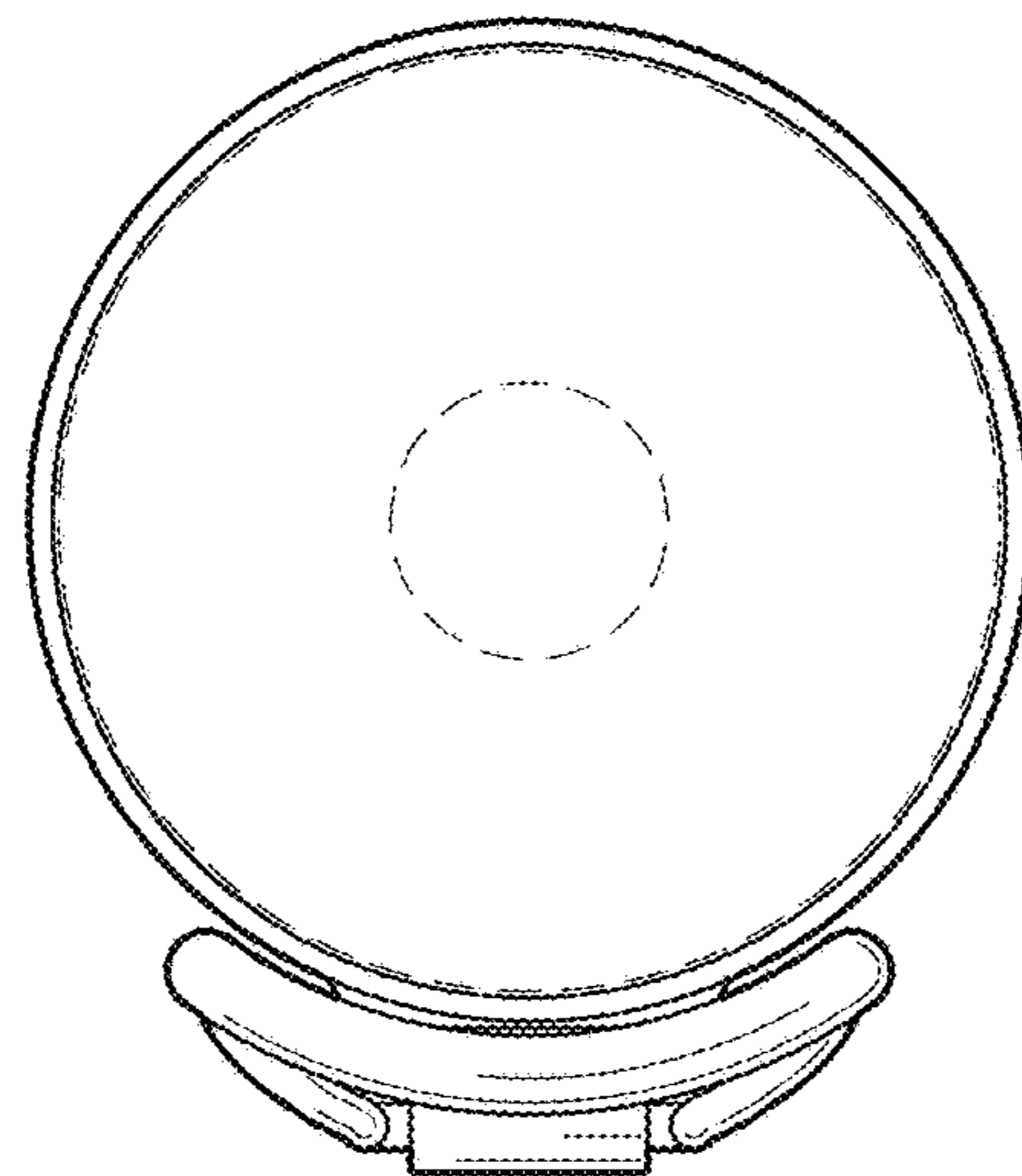

FIG. 32

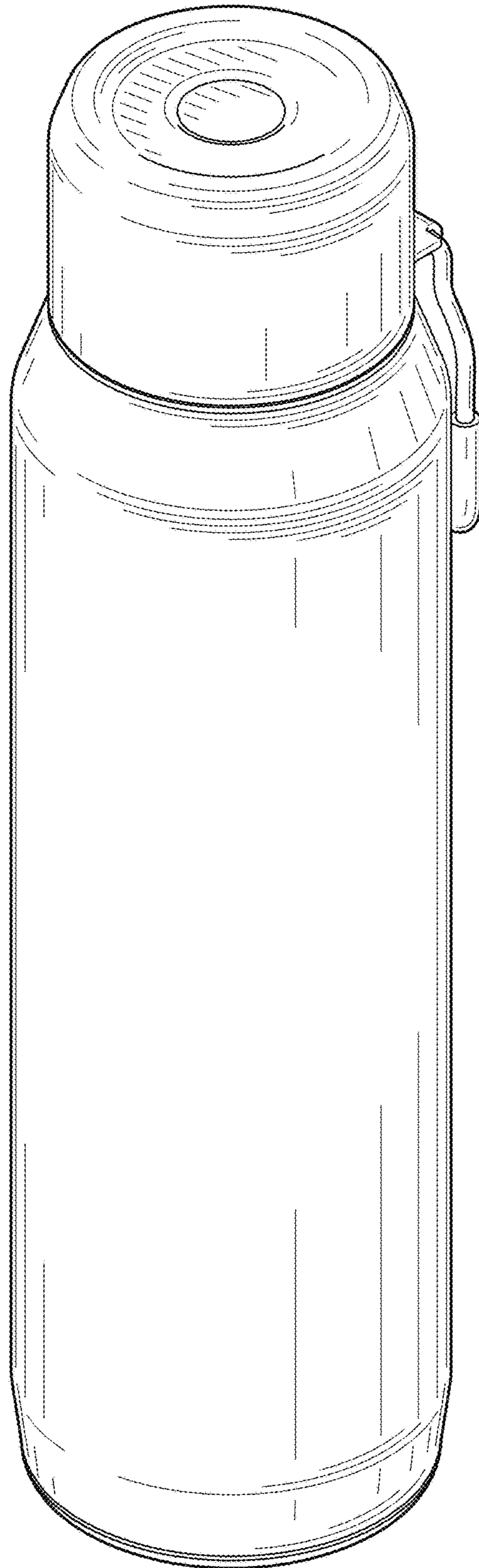

FIG. 33

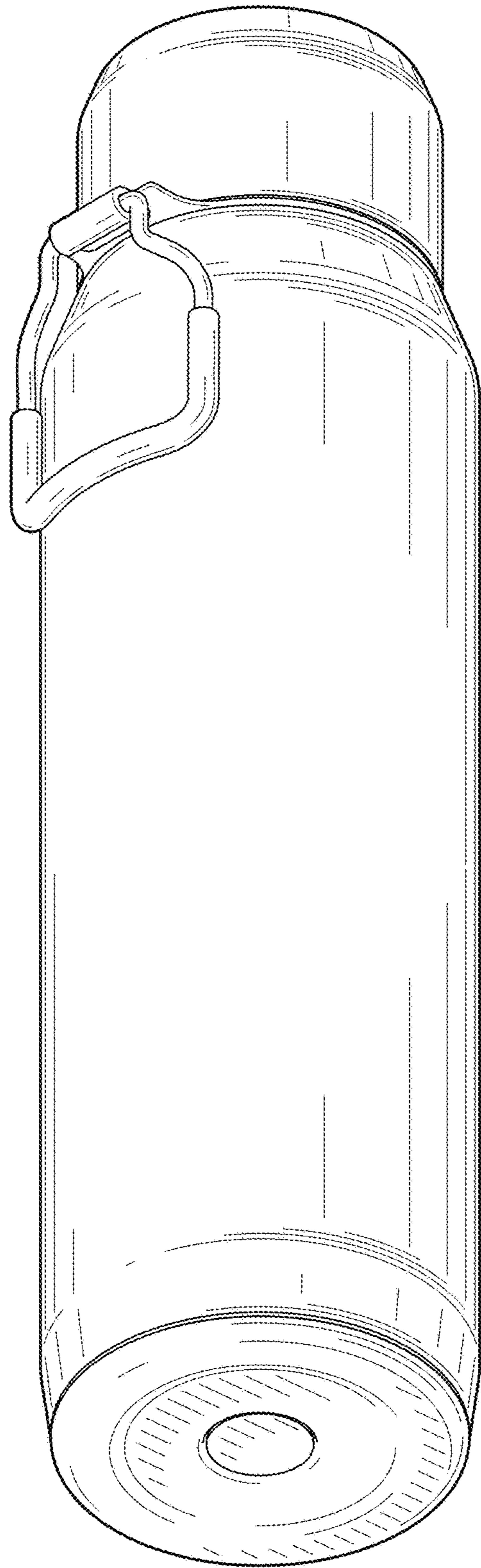

FIG. 34

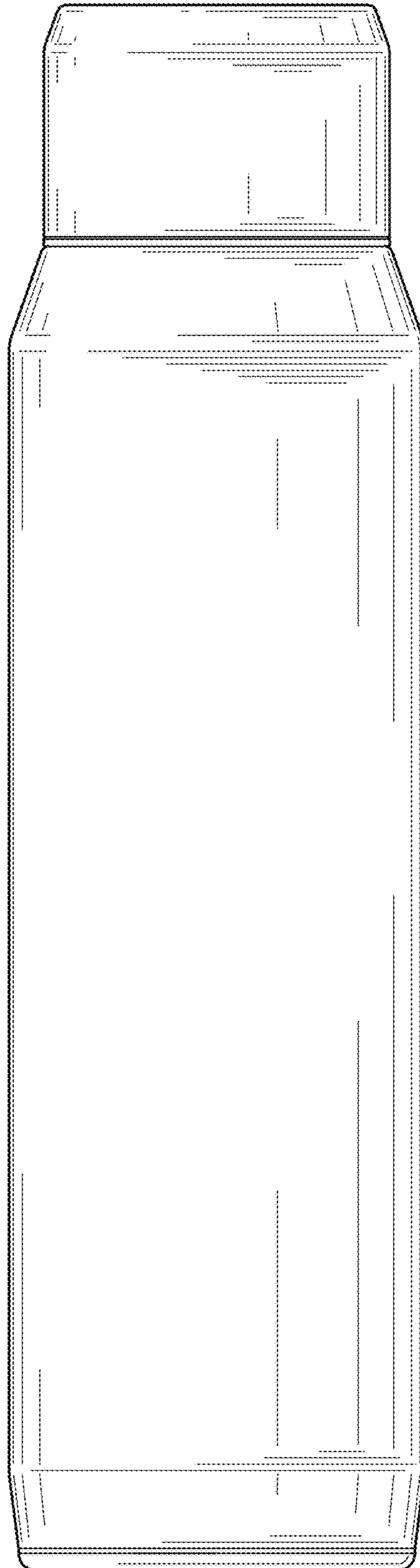

FIG. 35

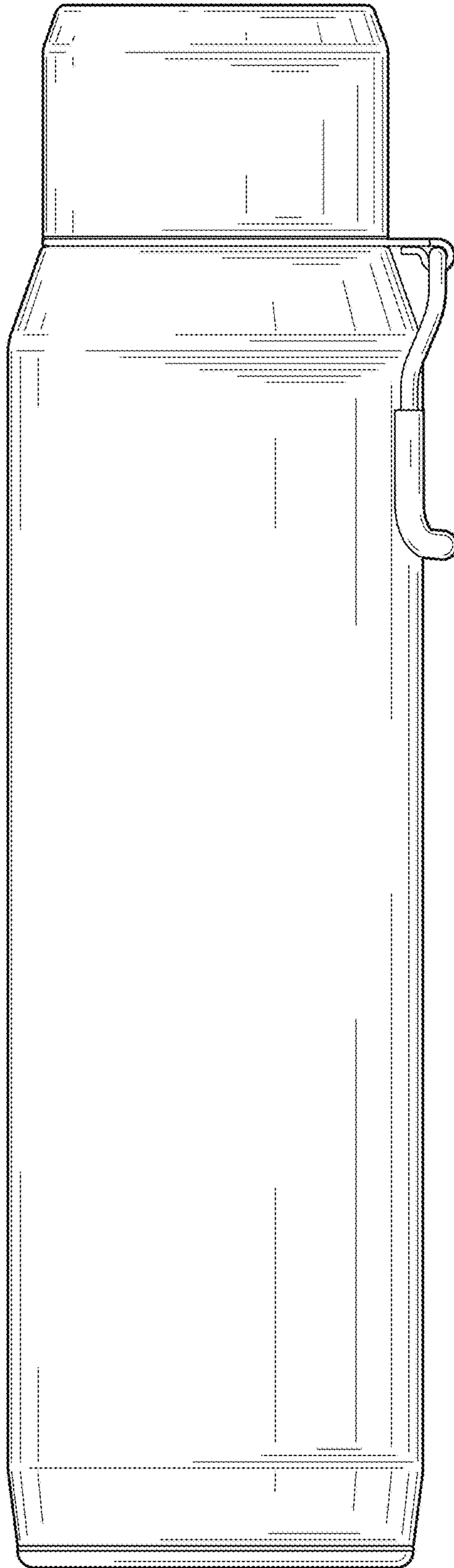

FIG. 36

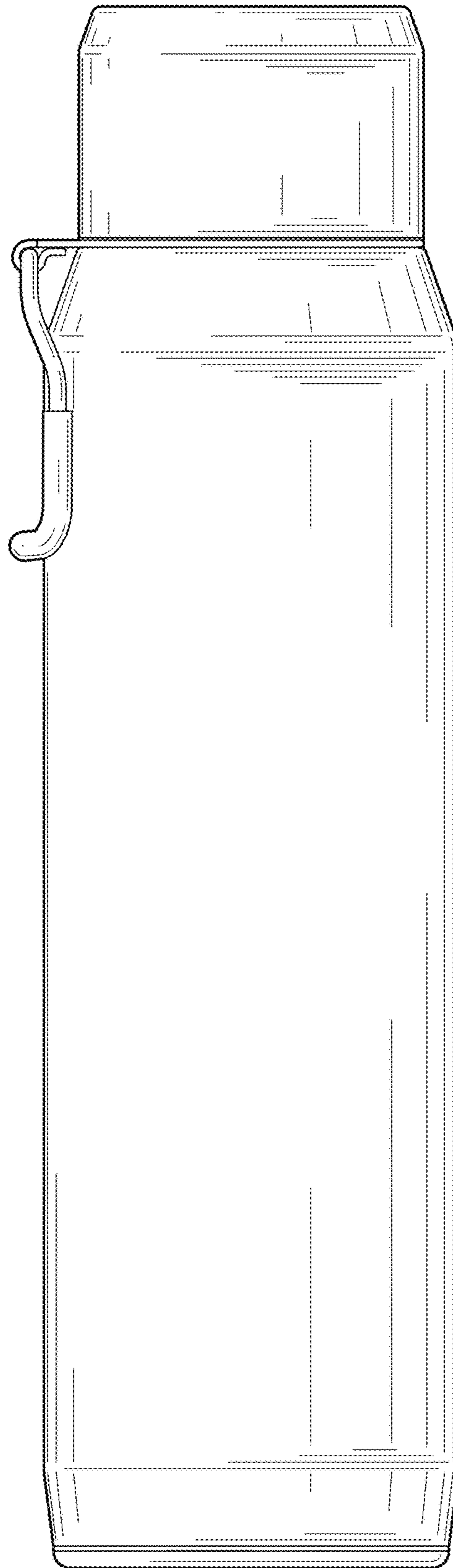

FIG. 37

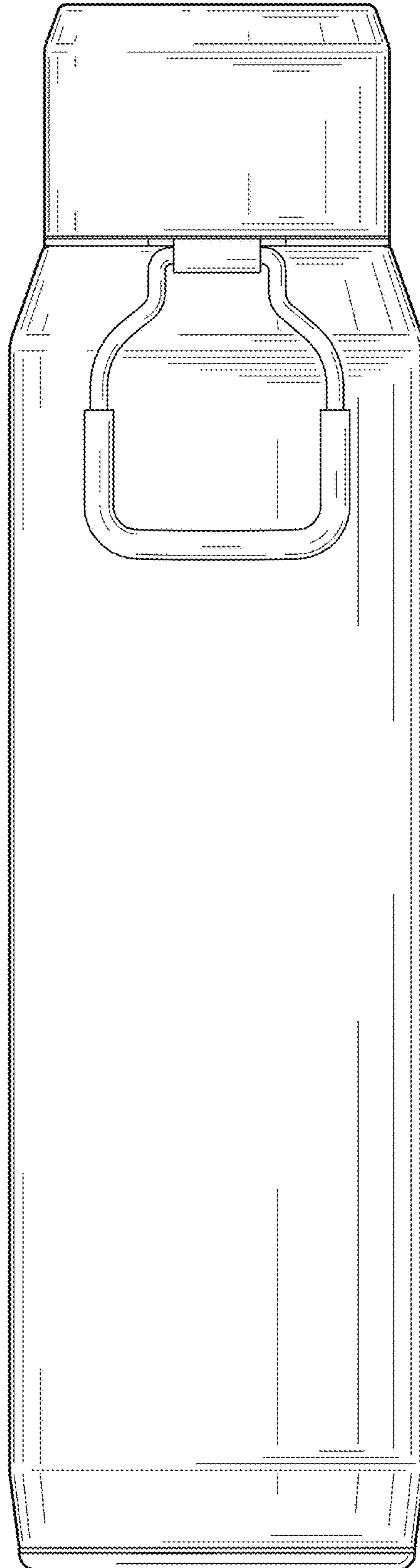

FIG. 38

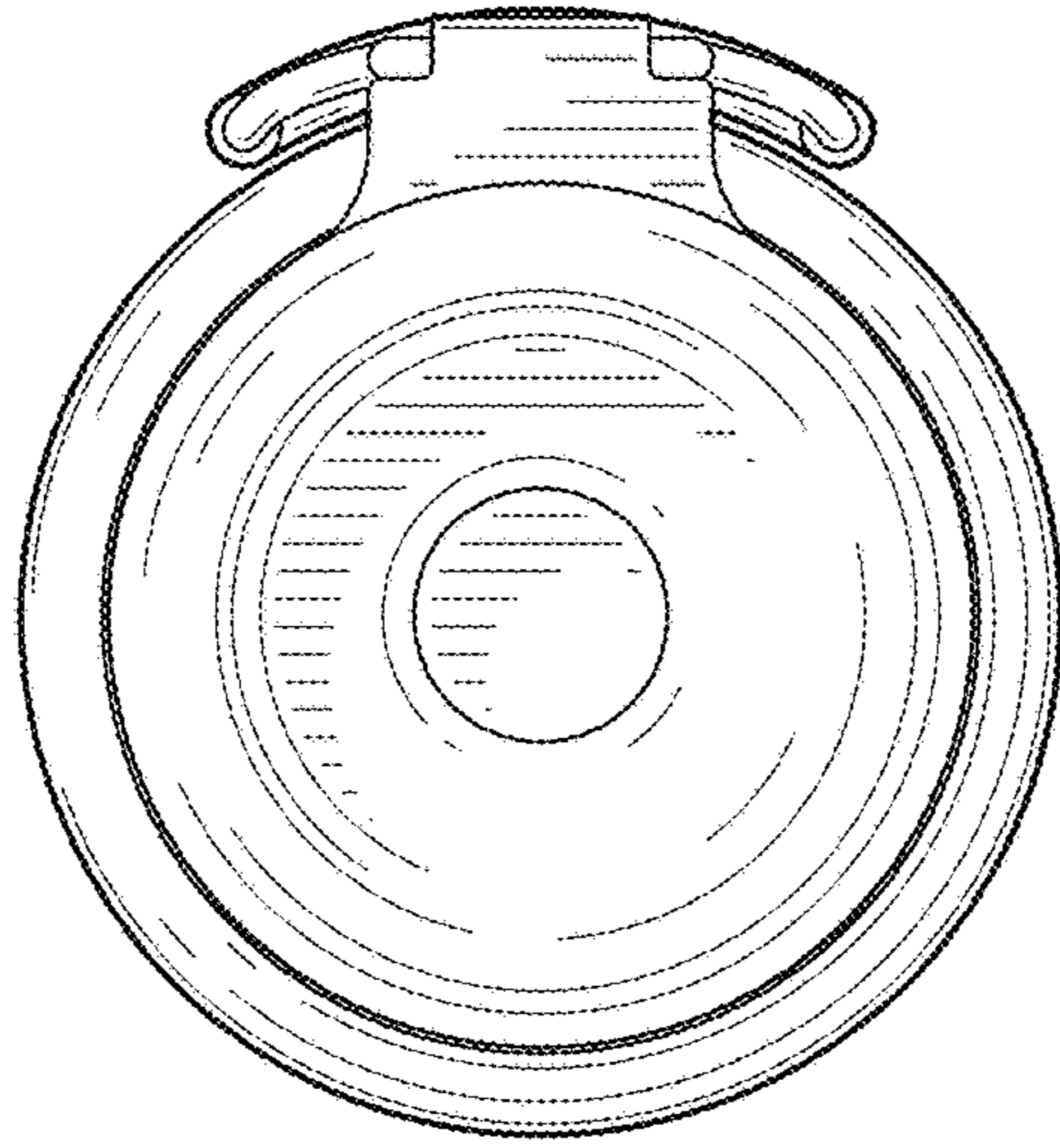

FIG. 39

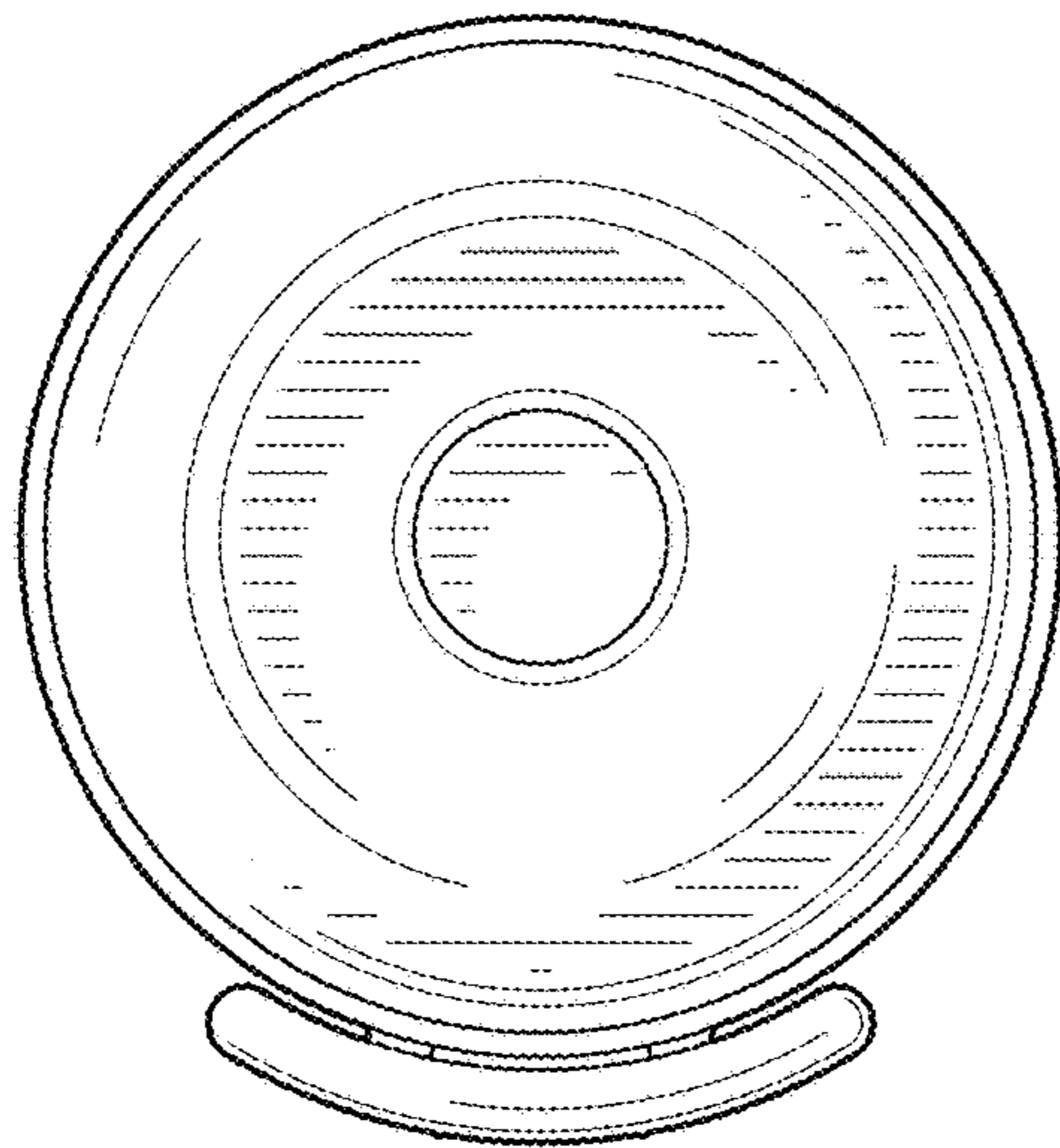

FIG. 40

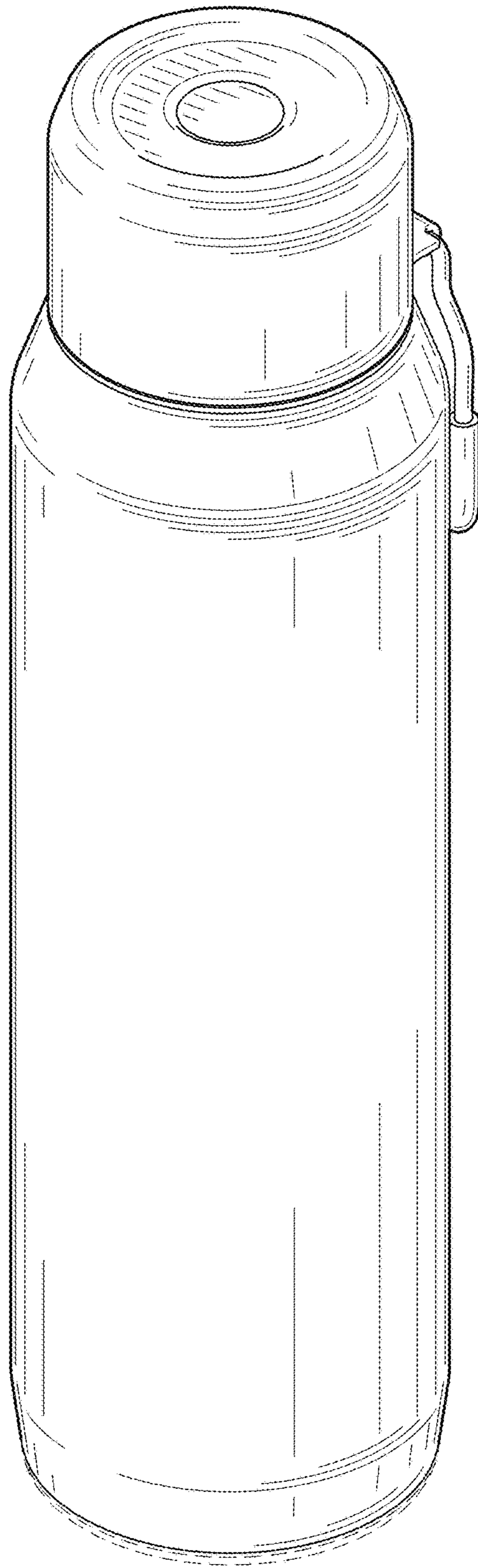

FIG. 41

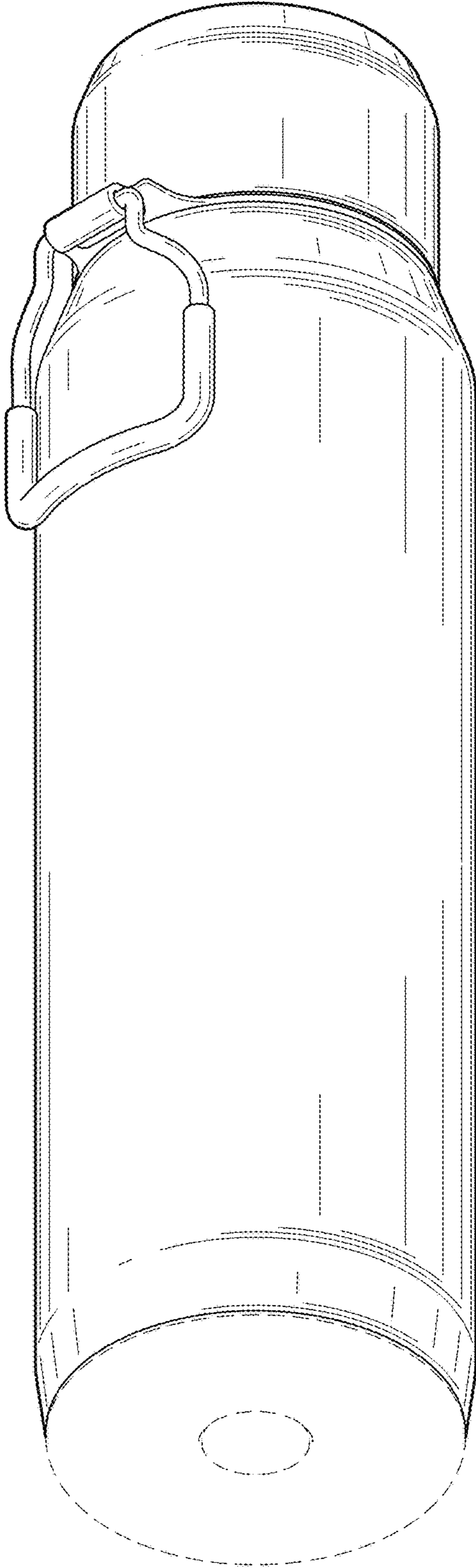

FIG. 42

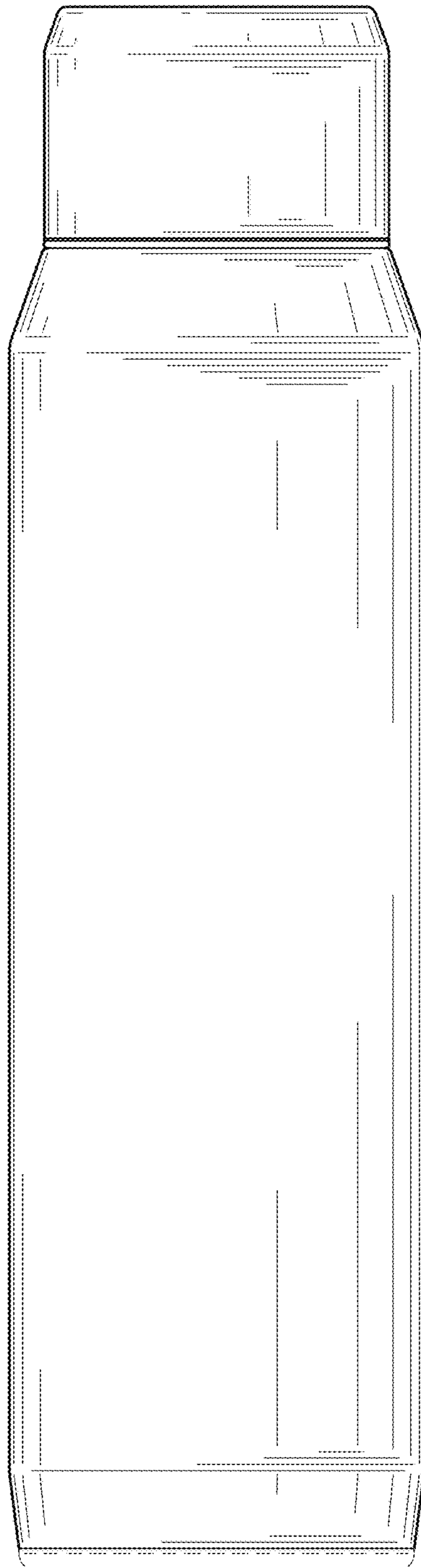

FIG. 43

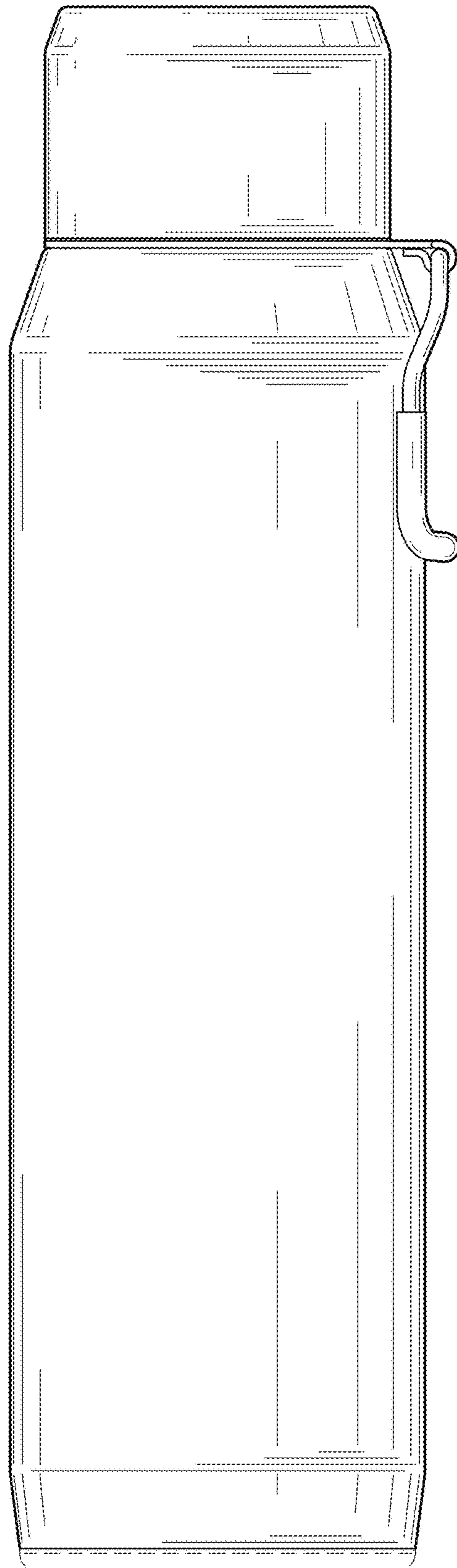

FIG. 44

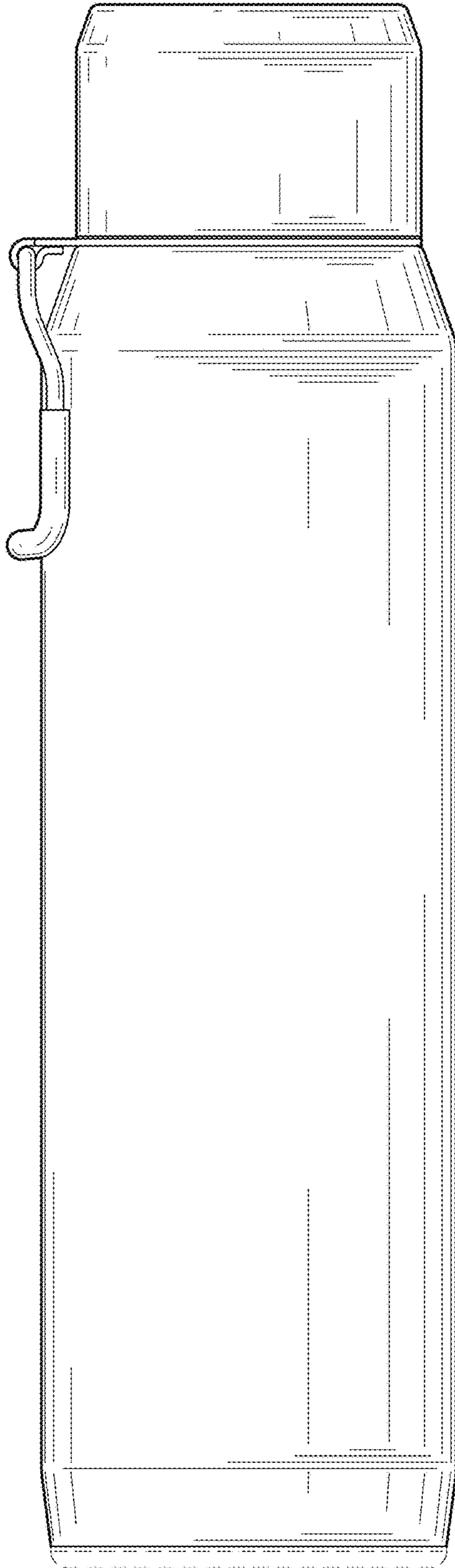

FIG. 45

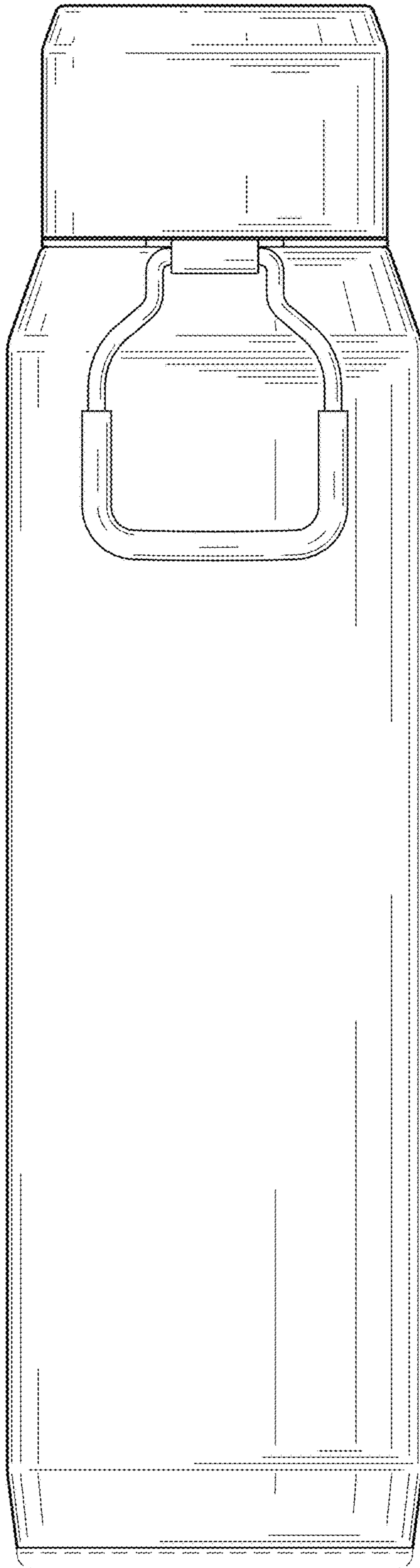

FIG. 46

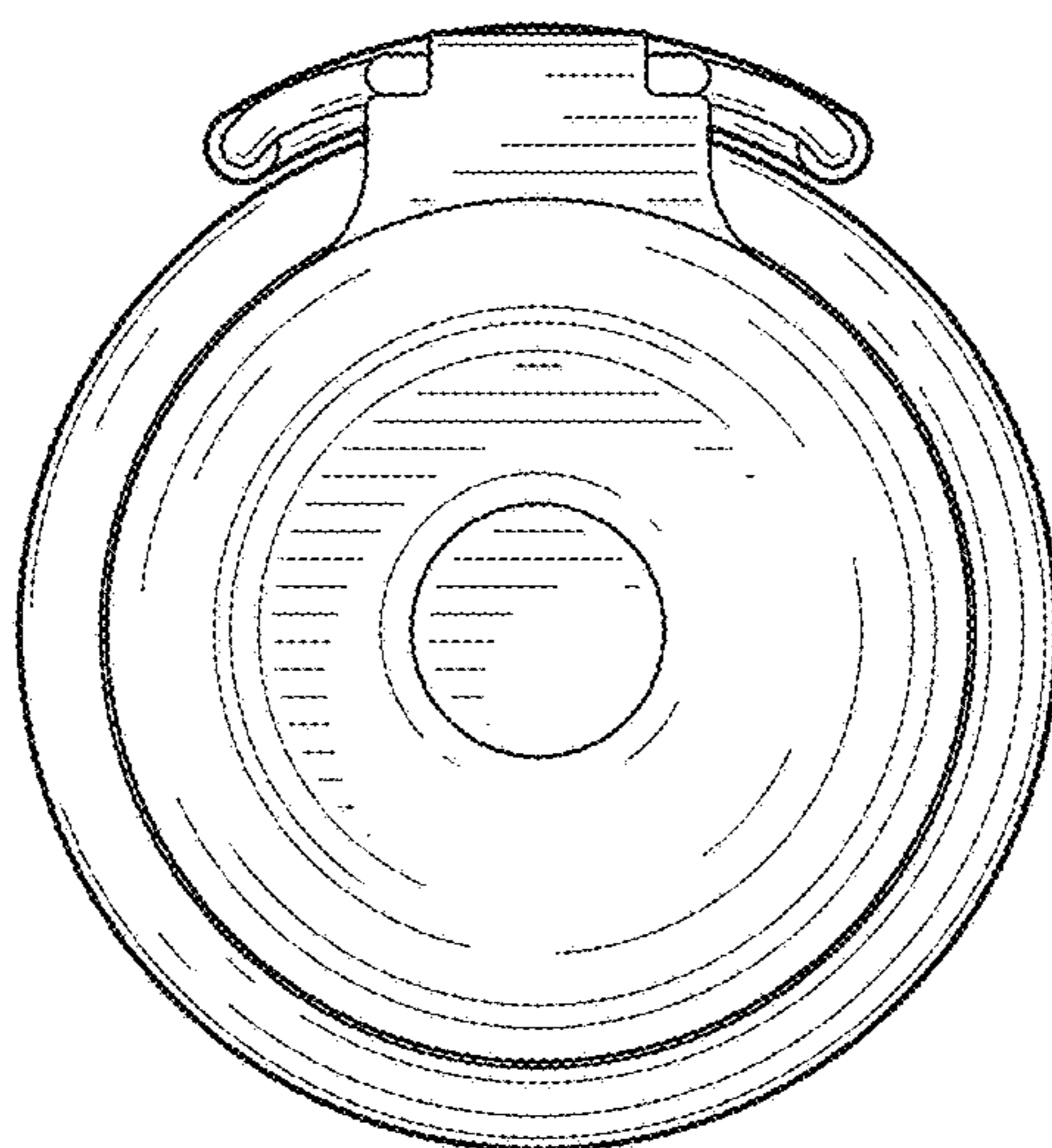

FIG. 47

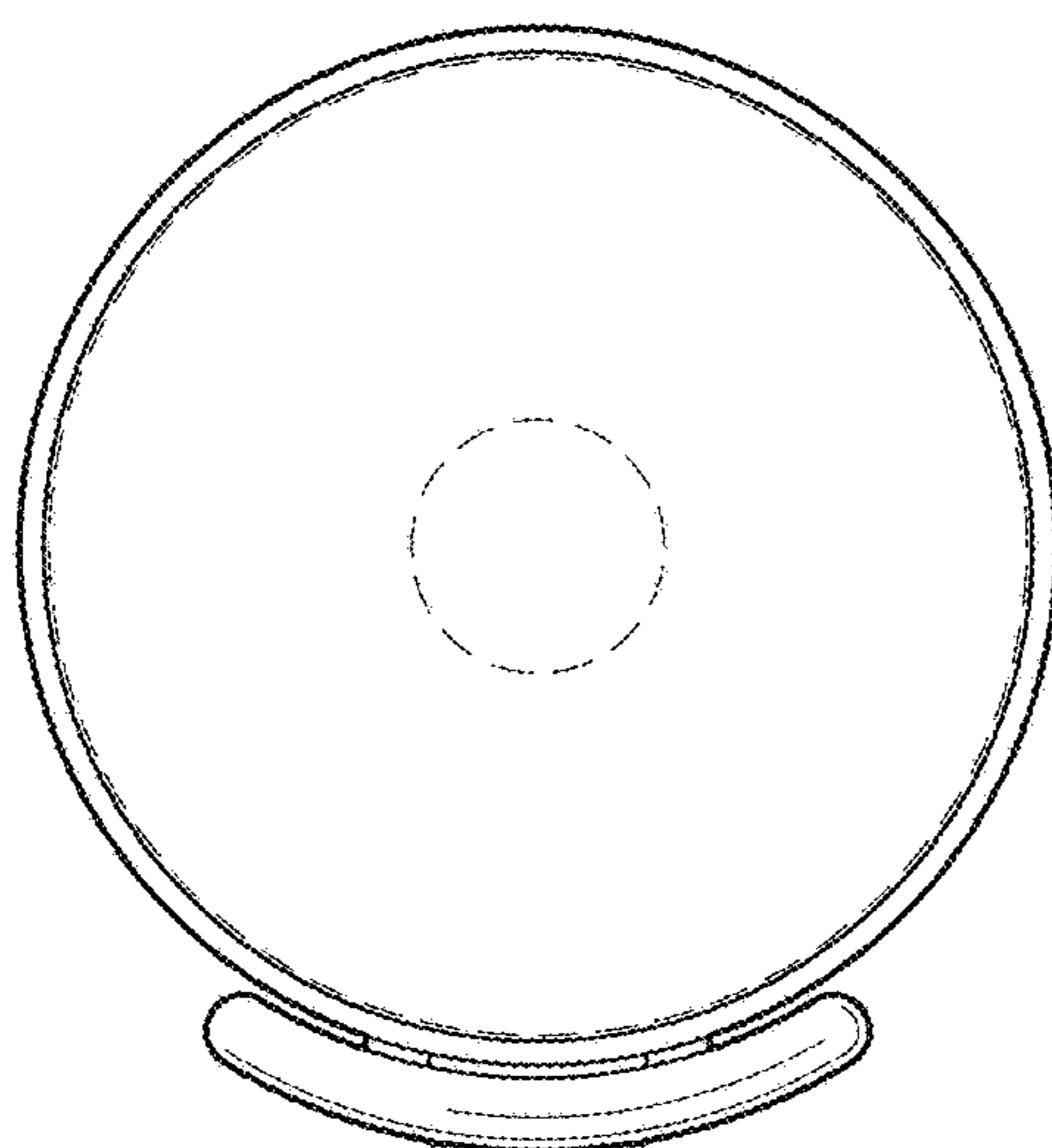

FIG. 48

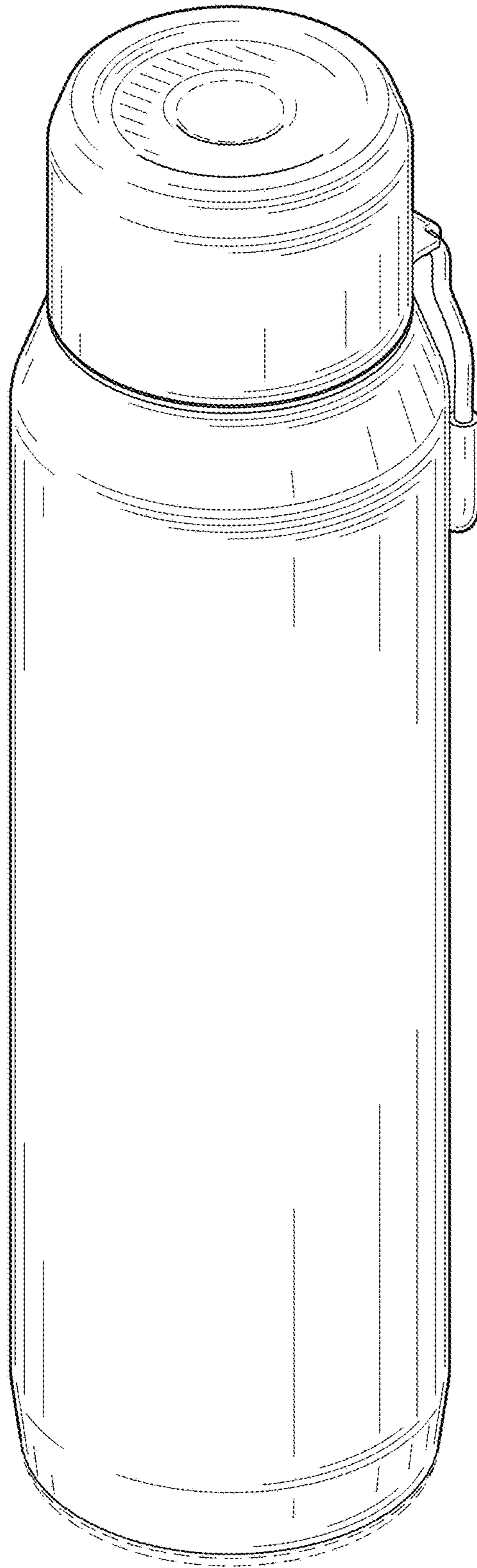

FIG. 49

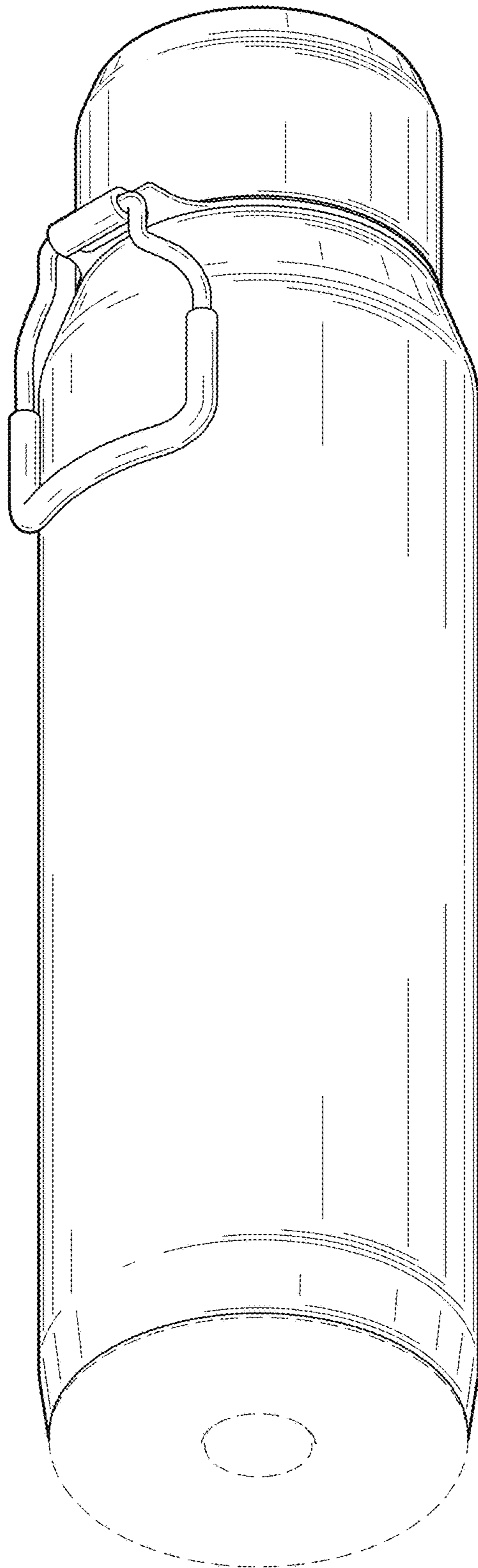

FIG. 50

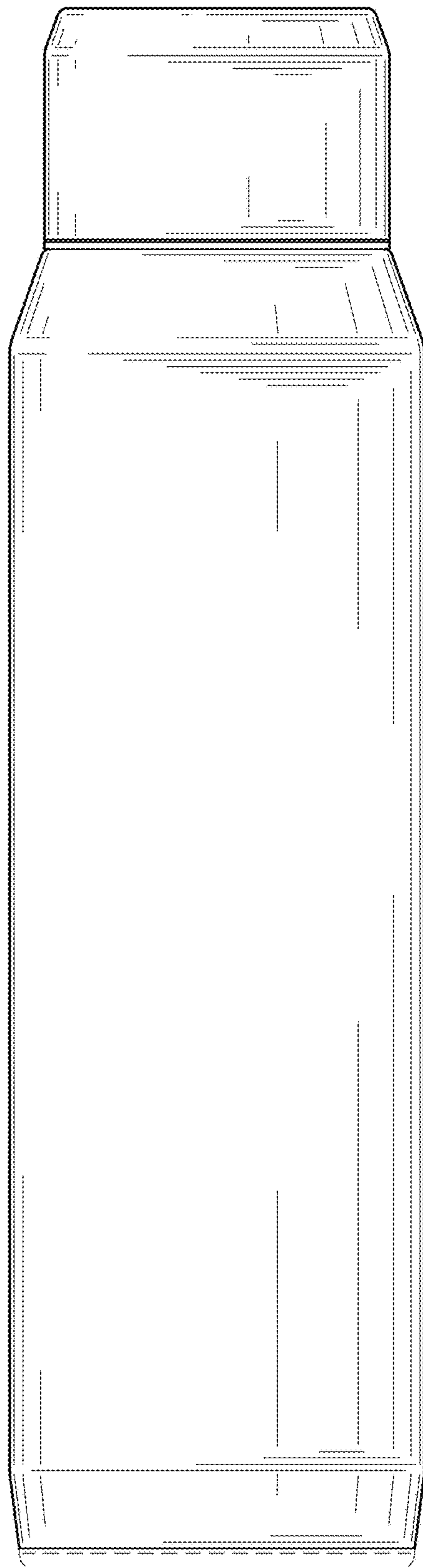

FIG. 51

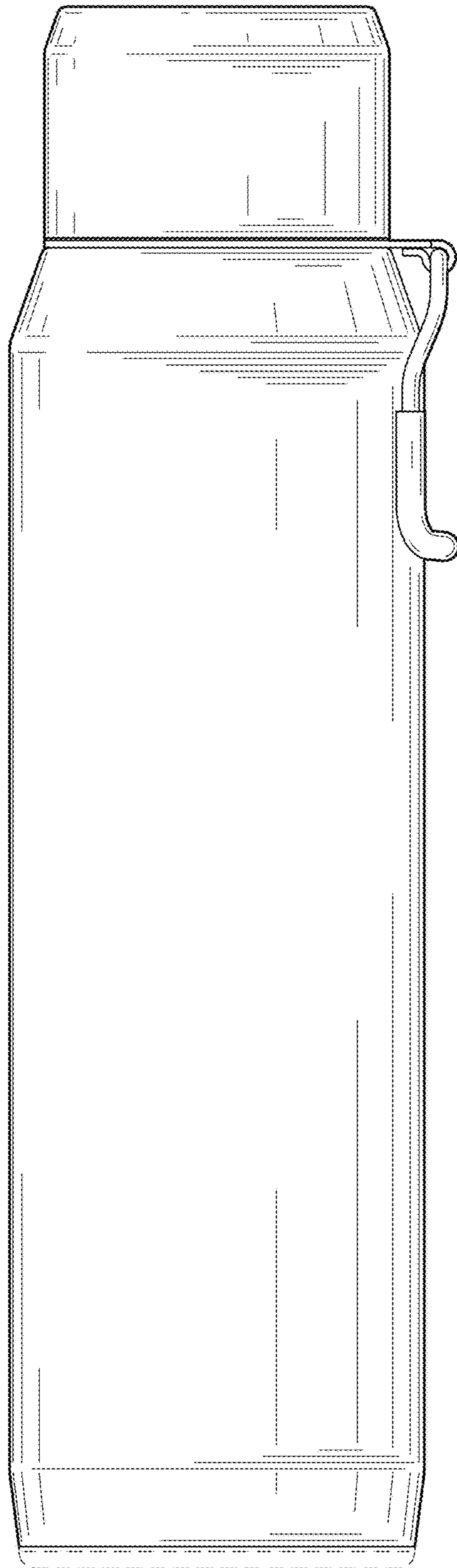

FIG. 52

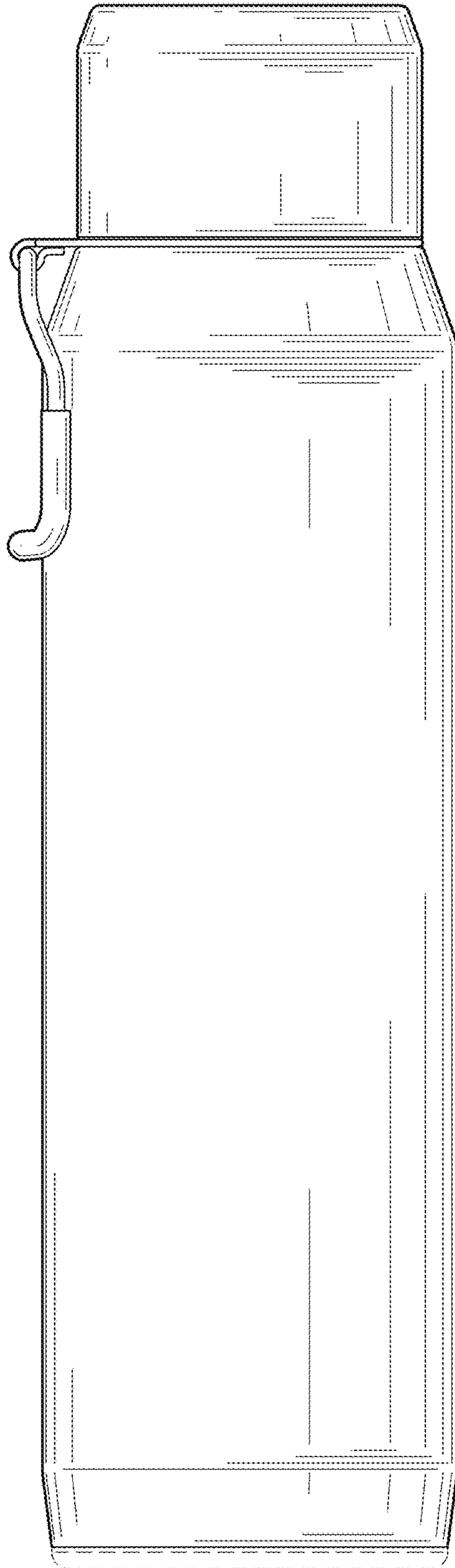

FIG. 53

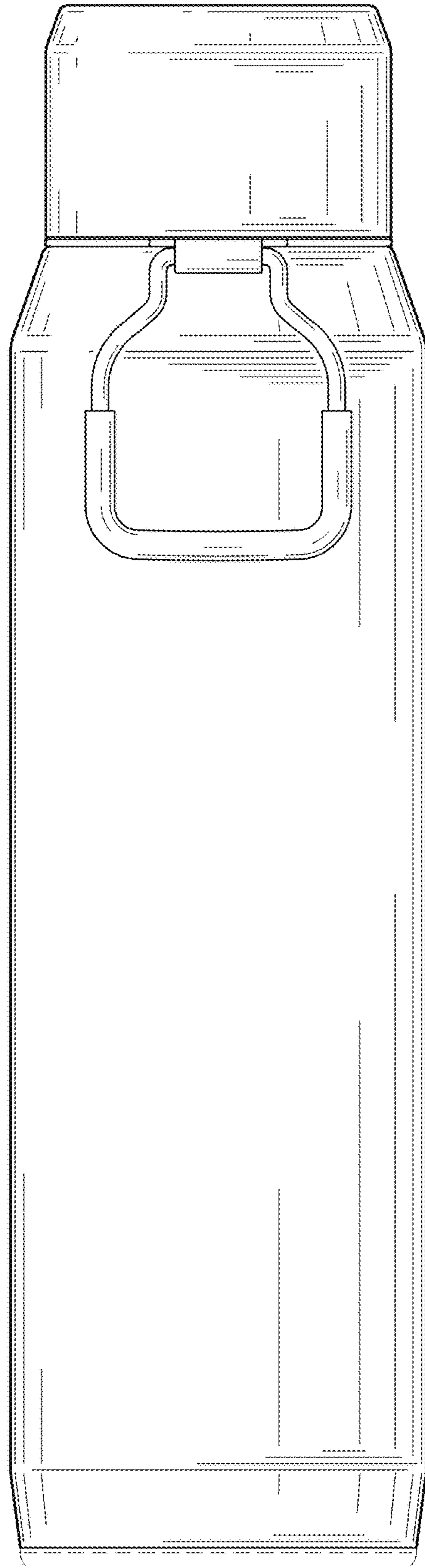

FIG. 54

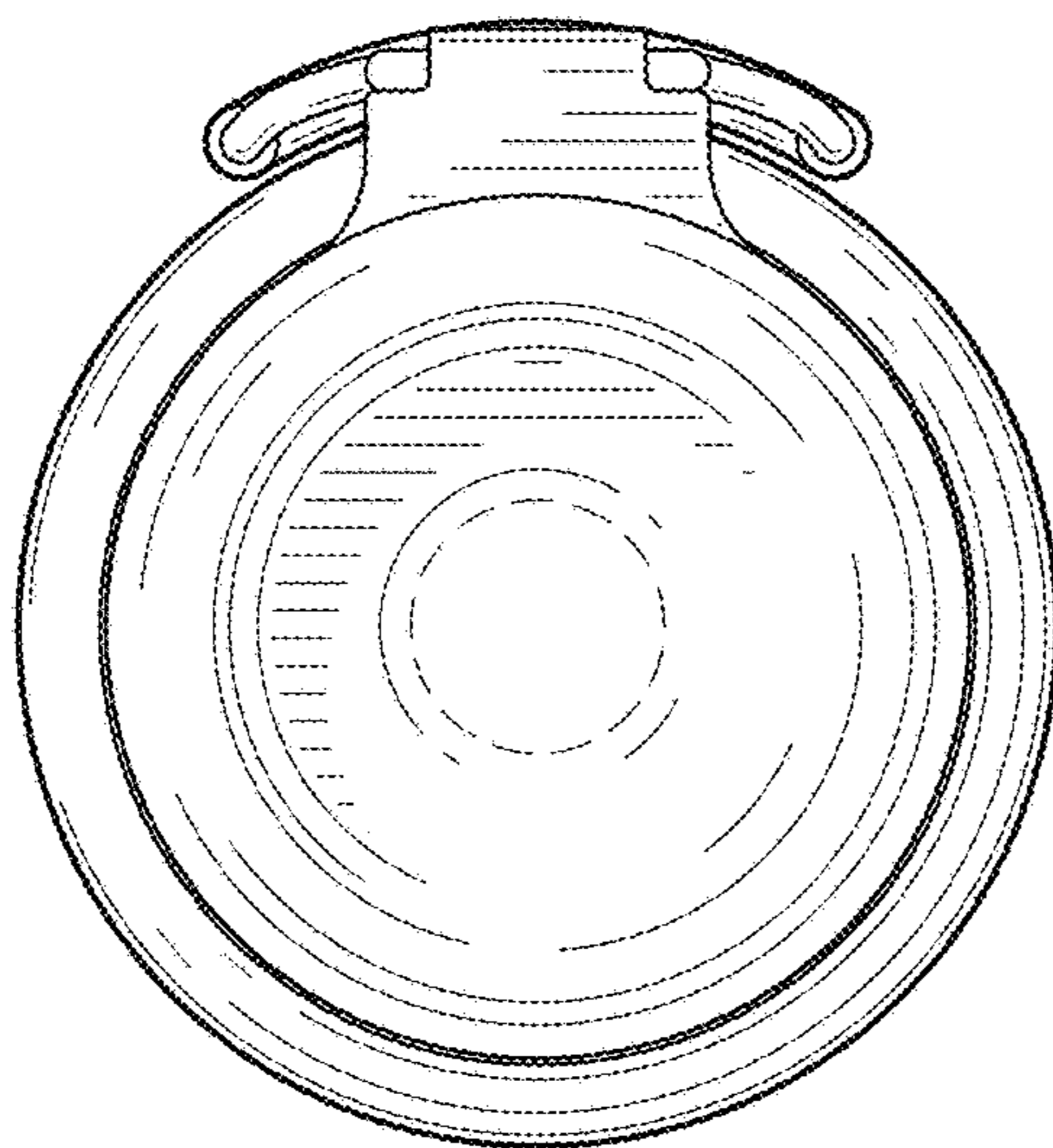

FIG. 55

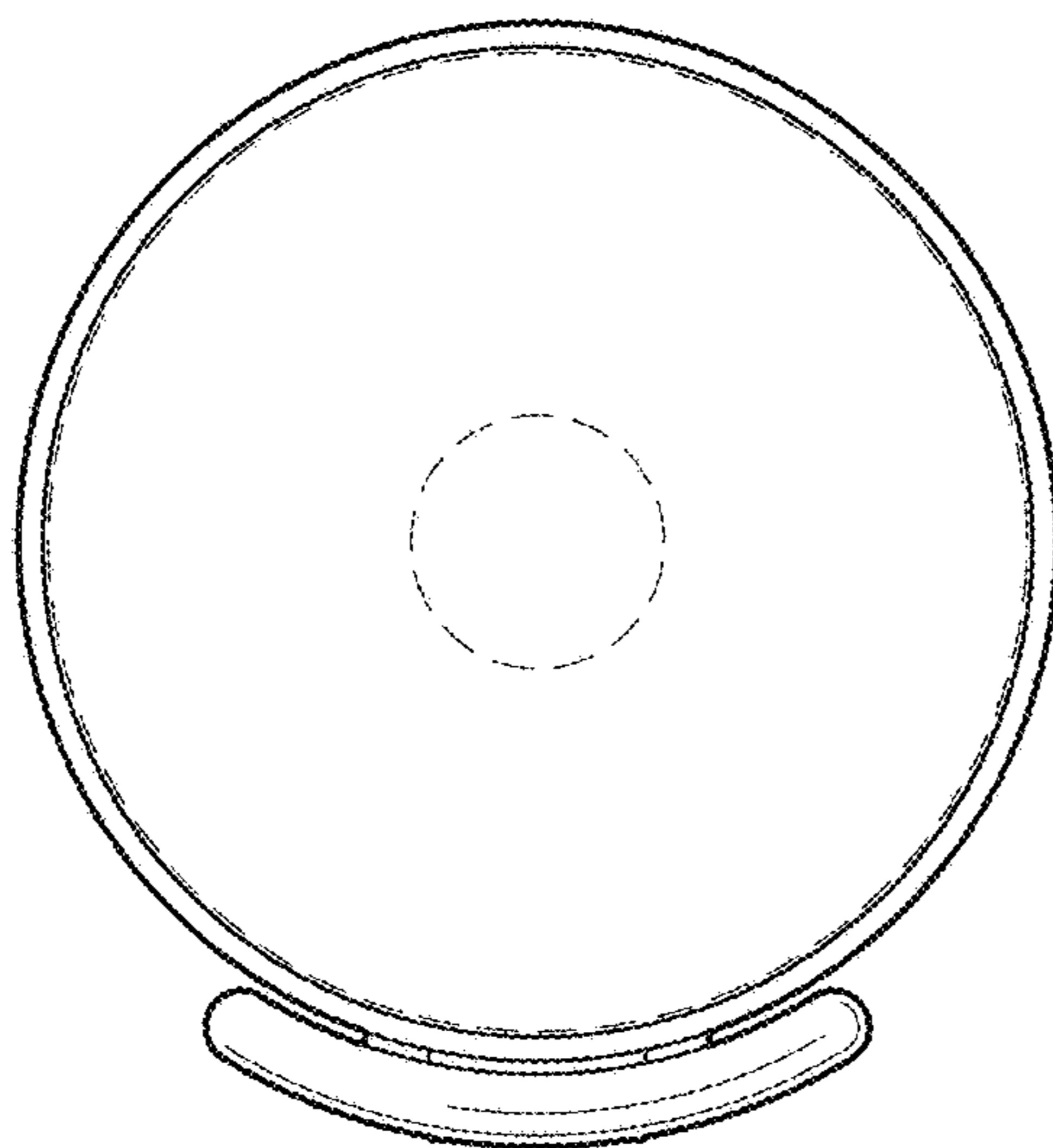

FIG. 56

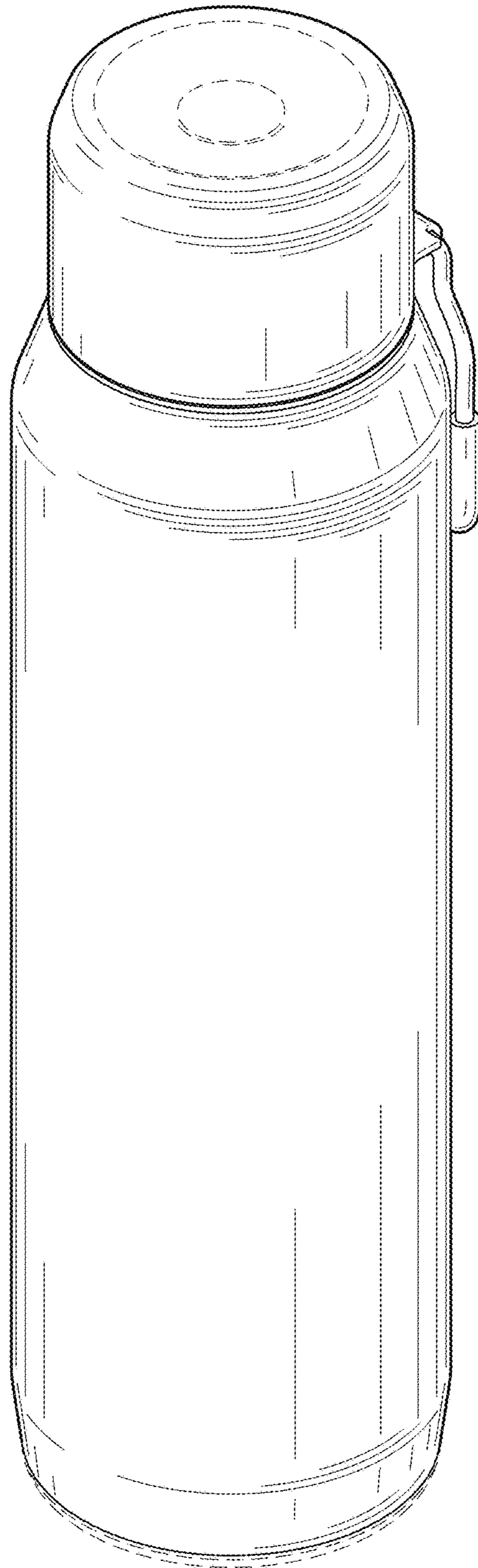

FIG. 57

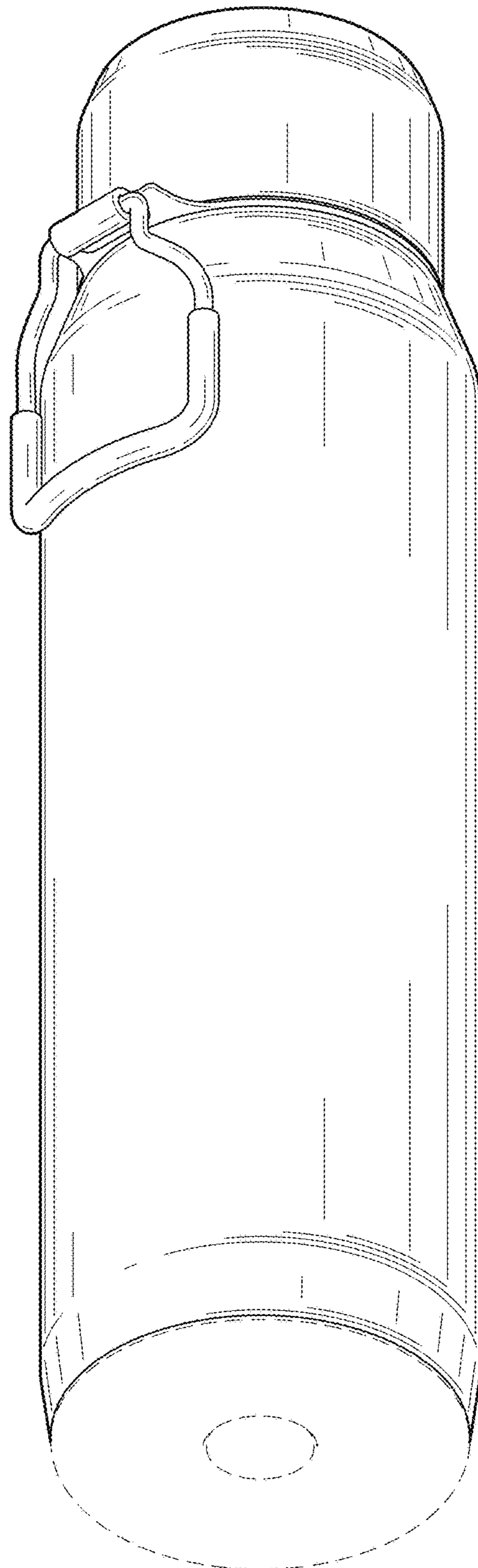

FIG. 58

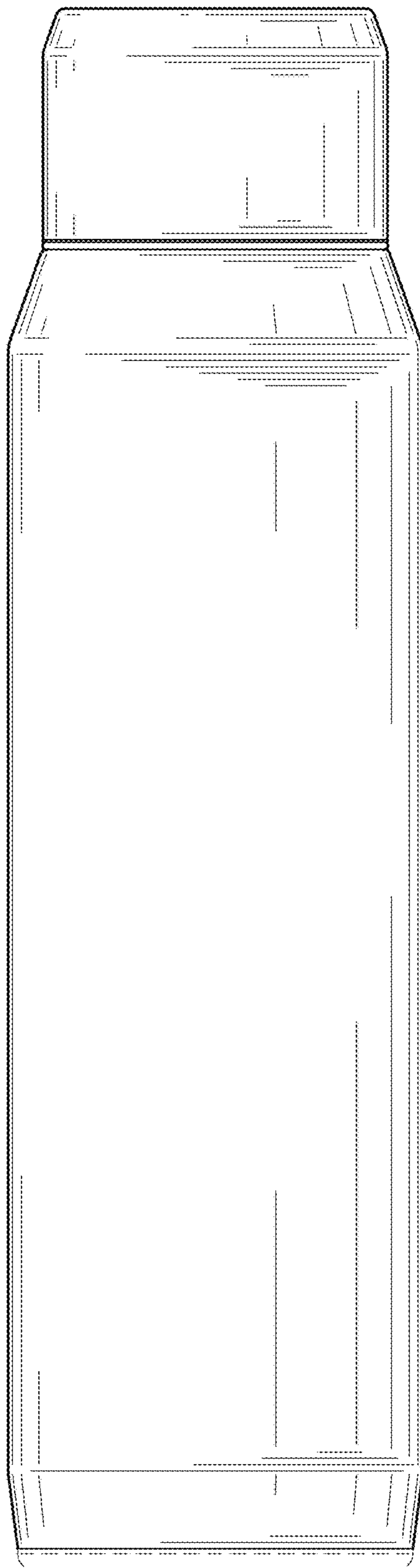

FIG. 59

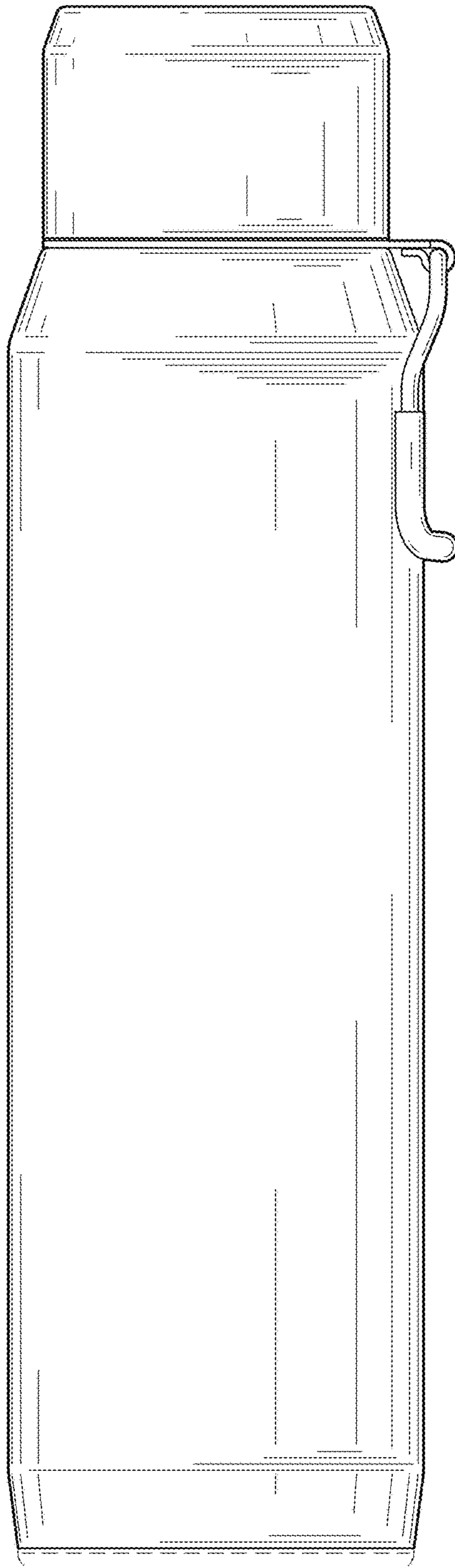

FIG. 60

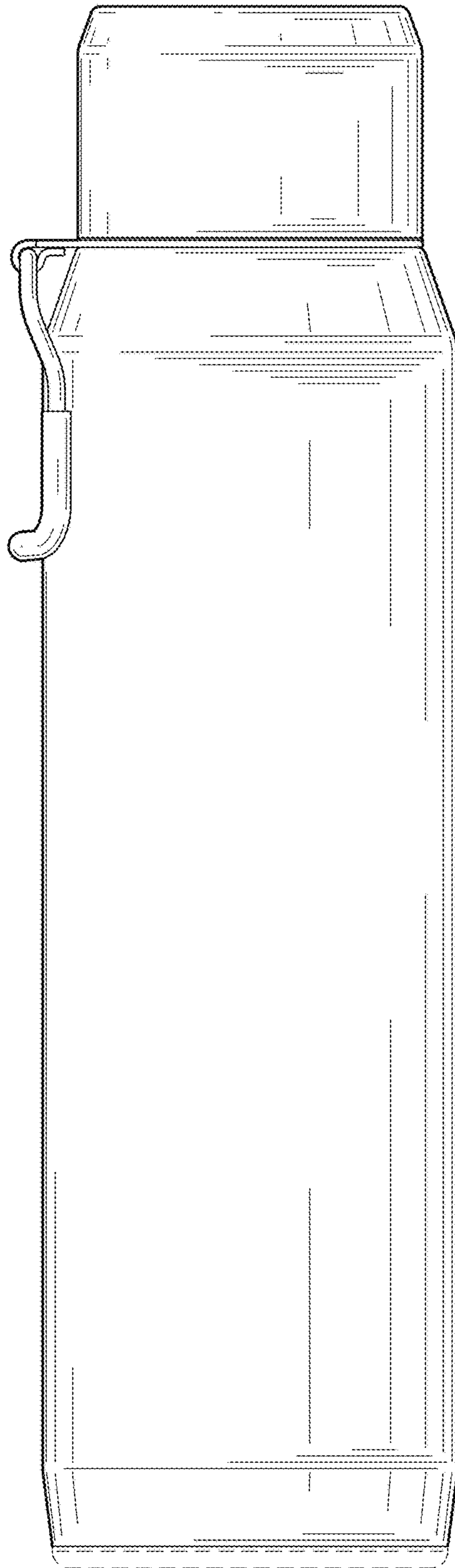

FIG. 61

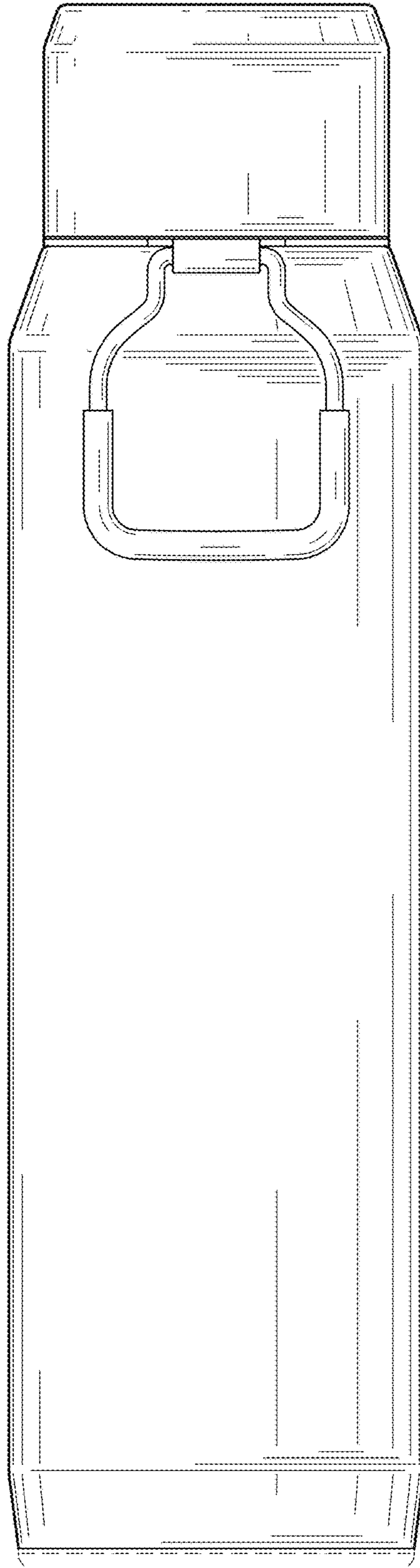

FIG. 62

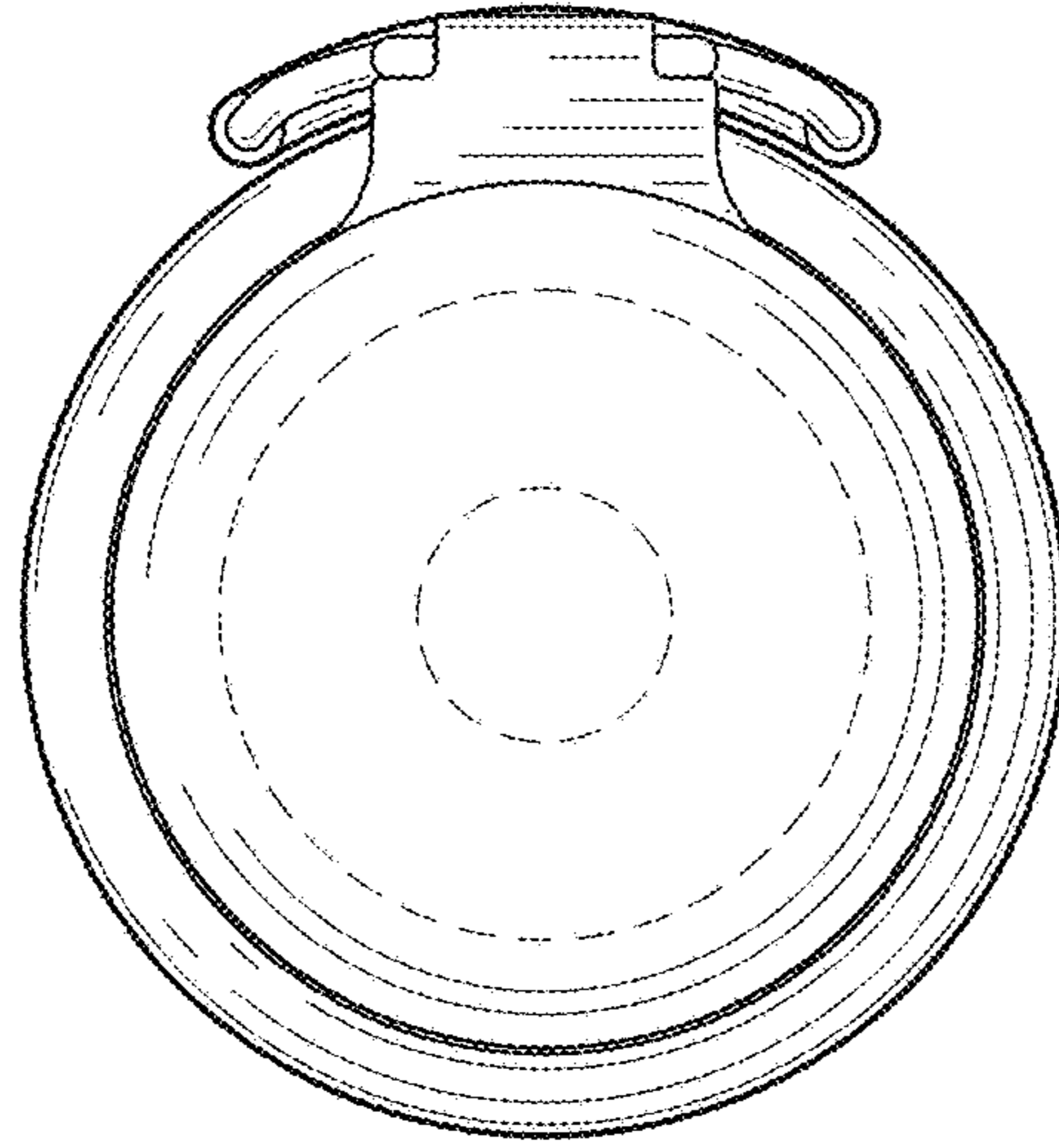

FIG. 63

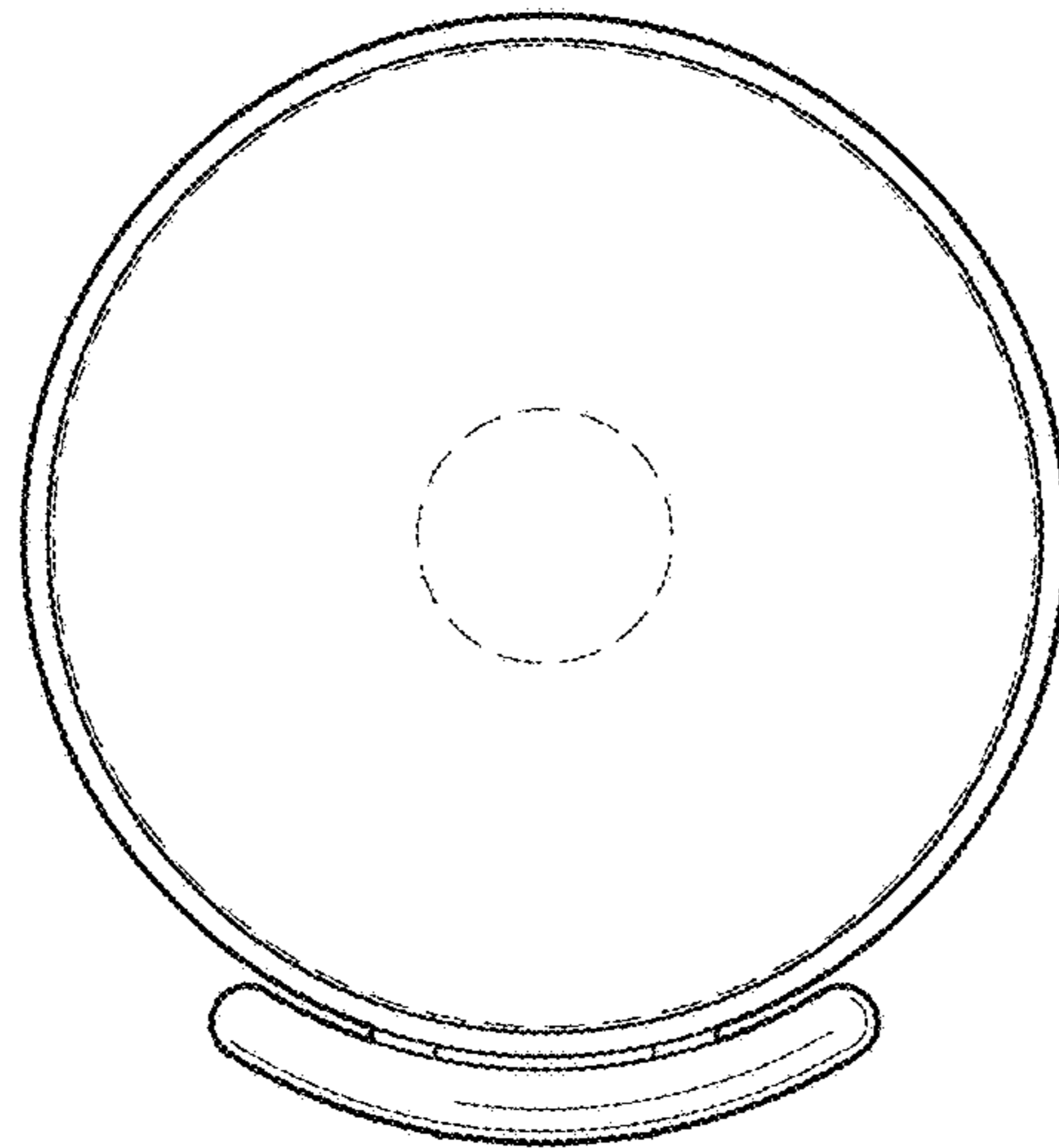

FIG. 64