



US00D819311S

(12) **United States Design Patent**
Jury et al.

(10) **Patent No.:** **US D819,311 S**
(45) **Date of Patent:** **** Jun. 5, 2018**

(54) **SHOE MIDSOLE**
(71) Applicant: **NIKE, Inc.**, Beaverton, OR (US)
(72) Inventors: **Chris Jury**, Portland, OR (US);
Matthew R. Pauk, Portland, OR (US)
(73) Assignee: **NIKE, Inc.**, Beaverton, OR (US)
(**) Term: **15 Years**

D336,766 S 6/1993 Sjosward
D402,795 S 12/1998 Moll et al.
D407,540 S 4/1999 Dolinsky
D419,284 S 1/2000 Dolinsky
D424,284 S 5/2000 von Conta et al.
D463,906 S 10/2002 Belley et al.
D465,911 S 11/2002 Belley et al.
D489,525 S * 5/2004 Snow D2/972
D524,016 S 7/2006 Robinson, Jr. et al.
D525,775 S 8/2006 Cintron
D558,971 S 1/2008 Wu
(Continued)

(21) Appl. No.: **29/623,602**
(22) Filed: **Oct. 25, 2017**
(51) **LOC (11) Cl.** **02-04**
(52) **U.S. Cl.**
USPC **D2/947**
(58) **Field of Classification Search**
USPC D2/902, 906, 908, 916, 918, 925,
D2/946-962, 977; D12/544; 36/1, 1.5,
36/3 B, 22 R, 24.5, 25 R, 28, 32 R, 34 R,
36/59 C, 67 A, 101-107, 114-116, 117.3,
36/117.4, 124-136
CPC A43B 13/00; A43B 13/02; A43B 13/023;
A43B 13/026; A43B 13/04; A43B 13/08;
A43B 13/10; A43B 13/12; A43B 13/14;
A43B 13/141; A43B 13/143; A43B
13/16; A43B 13/18; A43B 13/181; A43B
13/187; A43B 13/189; A43B 13/20; A43B
13/22; A43B 13/223; A43B 13/24; A43B
13/28; A43B 13/30; A43B 13/32; A43B
13/34; A43B 13/36
See application file for complete search history.

(56) **References Cited**
U.S. PATENT DOCUMENTS
4,785,557 A * 11/1988 Kelley A43B 13/12
36/30 R
D319,720 S 9/1991 Selbiger
D330,111 S * 10/1992 Hatfield D2/977
D332,861 S * 2/1993 Worthington D2/977

OTHER PUBLICATIONS

Nike Epic React Flyknit, Nike.com, [online], [site visited Jan. 31, 2018]. <URL: <https://www.nike.com/t/epic-react-flyknit-mens-running-shoe-ZwTJE04z>> (Year: 2018).*
(Continued)

Primary Examiner — T. Chase Nelson
Assistant Examiner — Jonathan J. Han
(74) *Attorney, Agent, or Firm* — Banner & Witcoff, Ltd.

(57) **CLAIM**

The ornamental design for a shoe midsole, as shown and described.

DESCRIPTION

FIG. 1 is a rear perspective view of a shoe midsole showing our new design;
FIG. 2 is a side view thereof;
FIG. 3 is a rear view thereof;
FIG. 4 is an opposite side view thereof; and,
FIG. 5 is second rear perspective view thereof.
The broken lines immediately adjacent to the shaded area define the bounds of the claimed design and form no part thereof. The broken lines showing the remainder of the shoe represent unclaimed subject matter and form no part of the claimed design.

1 Claim, 5 Drawing Sheets

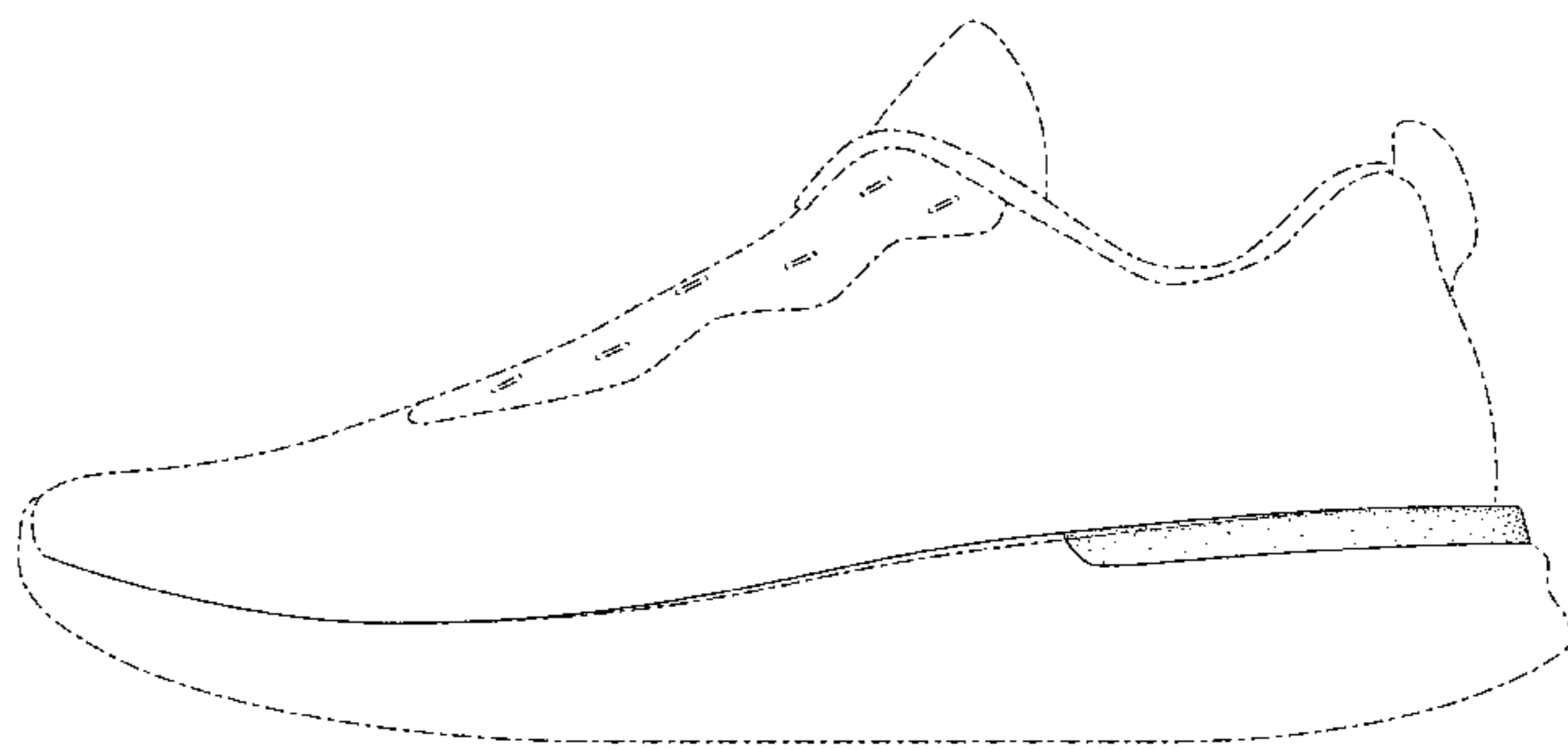
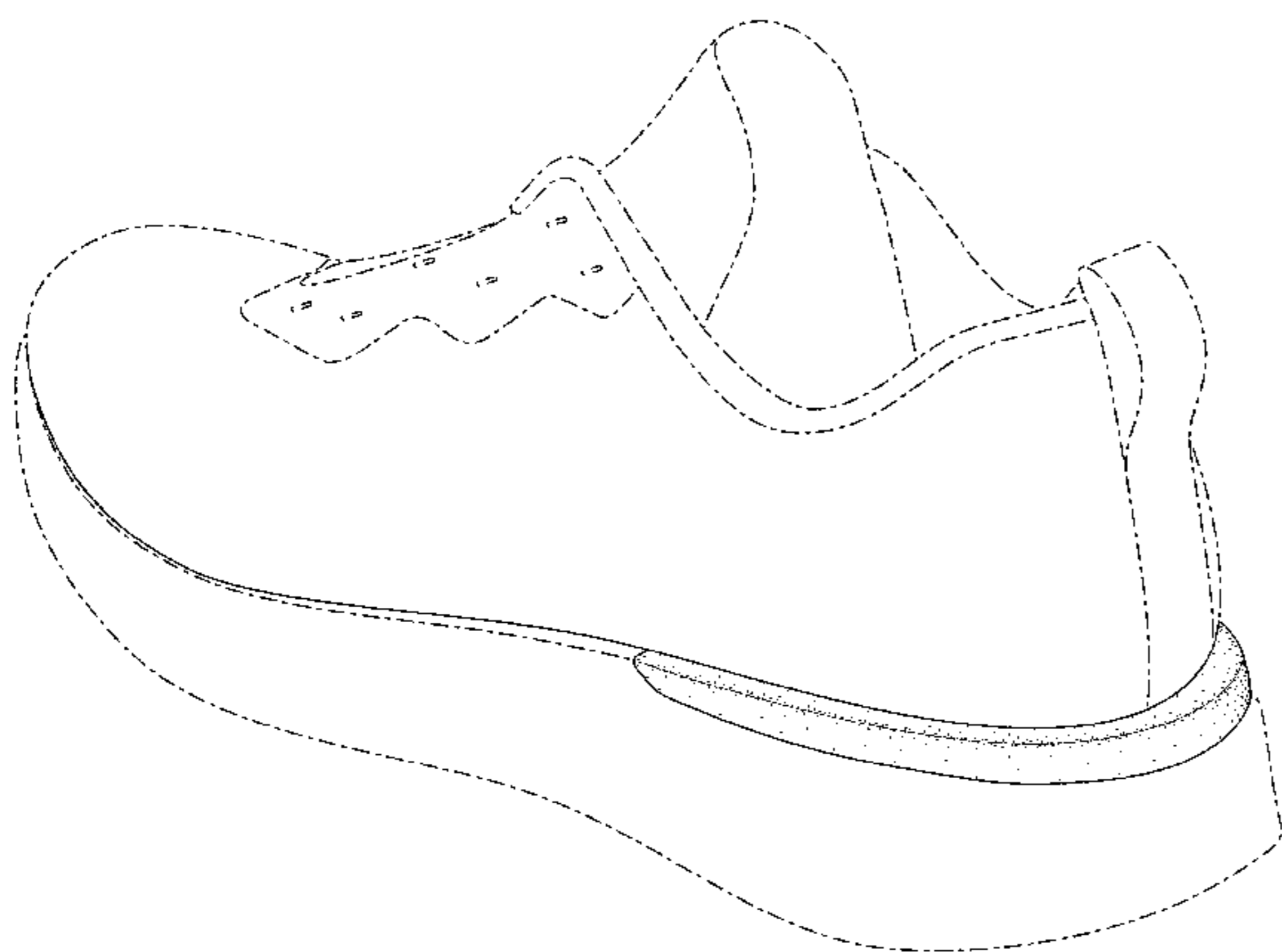

(56)

References Cited

U.S. PATENT DOCUMENTS

D561,452 S	2/2008	Belley et al.	
D569,093 S	5/2008	Morgan et al.	
D569,094 S	5/2008	Morgan et al.	
D613,041 S	4/2010	Thompson	
D613,480 S *	4/2010	Lamont	D2/902
D615,738 S *	5/2010	Teteriatnikov	D2/946
7,797,856 B2 *	9/2010	Andrews	A43B 13/12 36/25 R
D626,731 S	11/2010	Yi	
D636,570 S *	4/2011	Merritt	A43B 13/188 D2/951
D644,420 S	9/2011	Christopherson	
D667,617 S *	9/2012	Spring	D2/951
D670,479 S *	11/2012	Maier	D2/902
D680,714 S *	4/2013	Della Valle	D2/908
D731,761 S *	6/2015	Carroll	D2/907
D759,365 S	6/2016	Henderson et al.	
D768,969 S *	10/2016	Boys	D2/947
D778,568 S *	2/2017	Kinley	D2/964
D781,542 S *	3/2017	McGhee	D2/947
D782,165 S *	3/2017	Slimane	D2/902
D782,800 S *	4/2017	Smyth	D2/972
D785,295 S *	5/2017	Carroll	D2/902
D792,067 S *	7/2017	Raysse	D2/947
D794,296 S *	8/2017	Lee	D2/947
D796,160 S *	9/2017	Guichot	D2/902
D798,547 S *	10/2017	Hobson	D2/908
D798,554 S *	10/2017	Swierszczk	D2/947
D804,784 S *	12/2017	Romero	D2/902
D806,995 S *	1/2018	T.ae butted.stensen	D2/923
2010/0083535 A1 *	4/2010	Meschter	A43B 7/1495 36/88
2010/0107448 A1 *	5/2010	Fallow	A43B 3/0042 36/103
2013/0031804 A1 *	2/2013	Abshire	A43B 7/1425 36/103
2014/0082968 A1 *	3/2014	Binzer	A43B 13/22 36/103

OTHER PUBLICATIONS

Nike Dual Racer, Nike.com, [online], [site visited Jan. 31, 2018]. <URL: <https://www.nike.com/t/duel-racer-mens-shoe-kAWeVN/918228-402>> (Year: 2018).*

Nike SB Koston Hypervulc, Nike.com, [online], [site visited Jan. 31, 2018]. <URL: <https://www.nike.com/t/sb-koston-hypervulc-mens-skateboarding-shoe-rBB4MR>> (Year: 2018).*

Altra Footwear Launches Ego Midsole Cushioning Technology, FootwearNews.com, by Barbara Schneider-Levy, Aug. 3, 2016, [online], [site visited Jan. 31, 2018]. <URL: <http://footwearnews.com/2016/focus/athle>> (Year: 2016).*

Nike Footwear Catalog, 2017 Spring Territory Sporting Goods Footwear Best NA, p. 25, published Aug. 1, 2014, NIKE, Inc., USA.

Nike Flyknit Racer—Upcoming “Multi-Color” Releases [online], [retrieved Dec. 18, 2017] Retrieved from Sneakernews.com [Internet] <URL: <https://sneakernews.com/2013/04/11/nike-flyknit-racer-upcoming-multi-color-releases/>>; 4 color sheets, Dated Apr. 11, 2013.

This Is What the Nike LunarGlide 8 Will Look Like [online], [retrieved Dec. 18, 2017] Retrieved from Kicksonfire.com [Internet] <URL: <https://www.kicksonfire.com/nike-lunarglide-8/>>; 7 color sheets, Dated Apr. 27, 2016.

Adidas NMD R1 “Raw Pink” Pack Drops This Friday [online], [retrieved Dec. 18, 2017] Retrieved from Sneakernews.com [Internet] <URL: <https://sneakernews.com/2017/08/29/adidas-nmd-r1-raw-pink-pack-release-info/>>; 4 color sheets, Dated Aug. 29, 2017.

The Nike Zoom Mariah Flyknit Racer Goes “Bordeaux” [online], [retrieved Dec. 8, 2017] Retrieved from Sneakernews.com [Internet] <URL: <https://sneakernews.com/2017/10/08/nike-zoom-mariah-flyknit-racer-bordeaux-navy/>>; 5 color sheets, Dated Oct. 8, 2017.

Nike LunarGlide 9 Review [online], [retrieved Dec. 18, 2017] Retrieved from Solereview.com [Internet] <URL: <https://www.solereview.com/nike-lunarglide-9-review/>>; 28 color sheets, Dated Nov. 15, 2017.

* cited by examiner

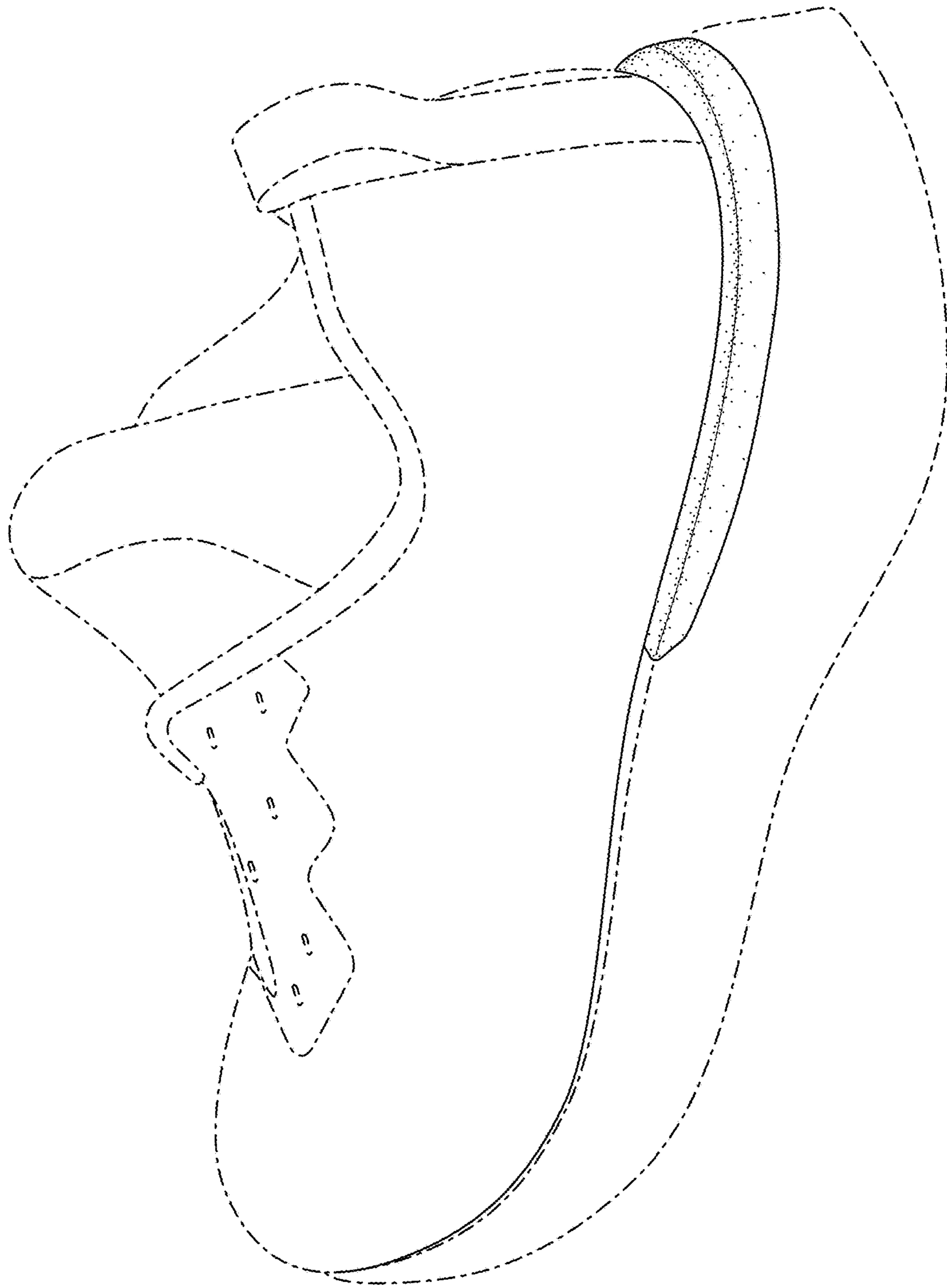

FIG. 1

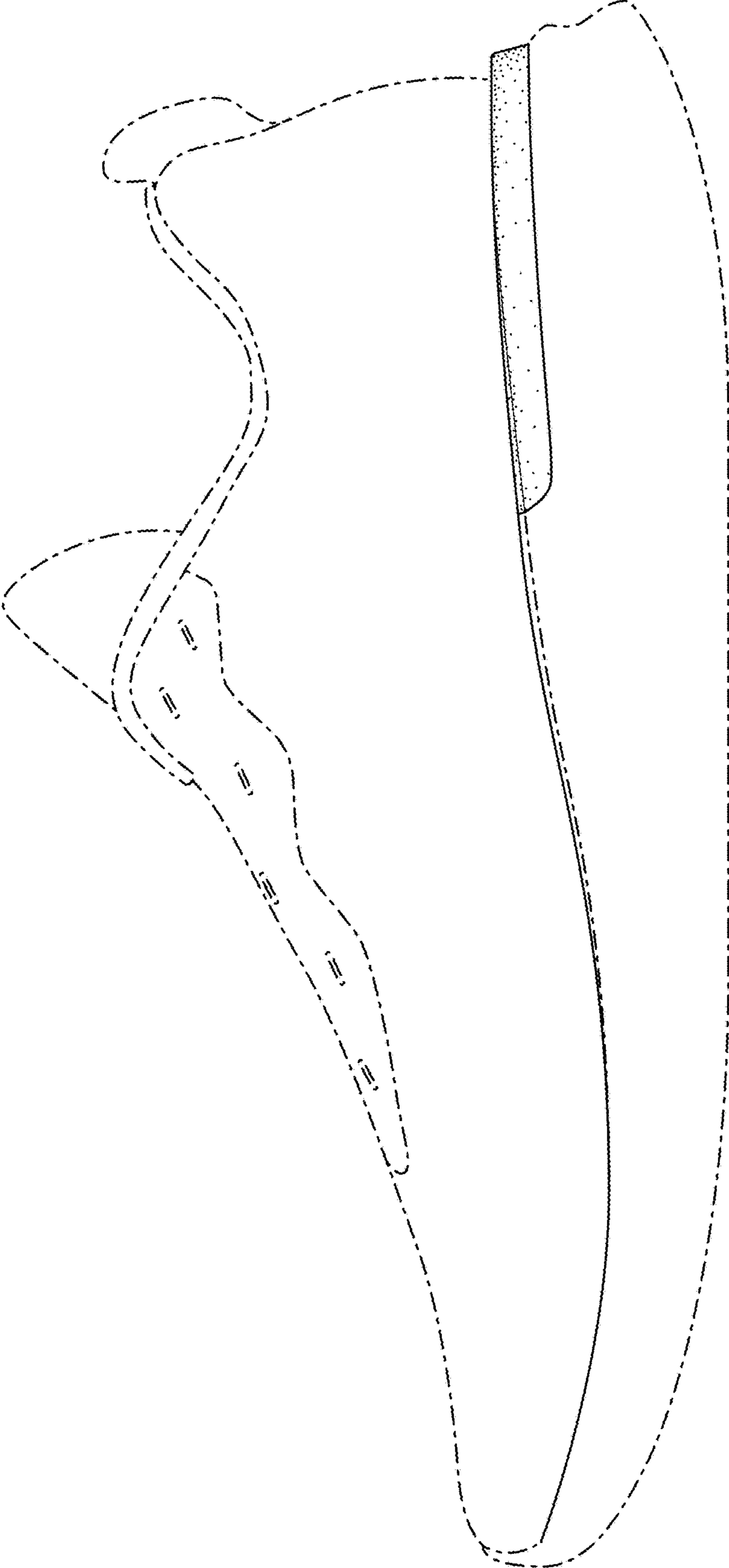

FIG. 2

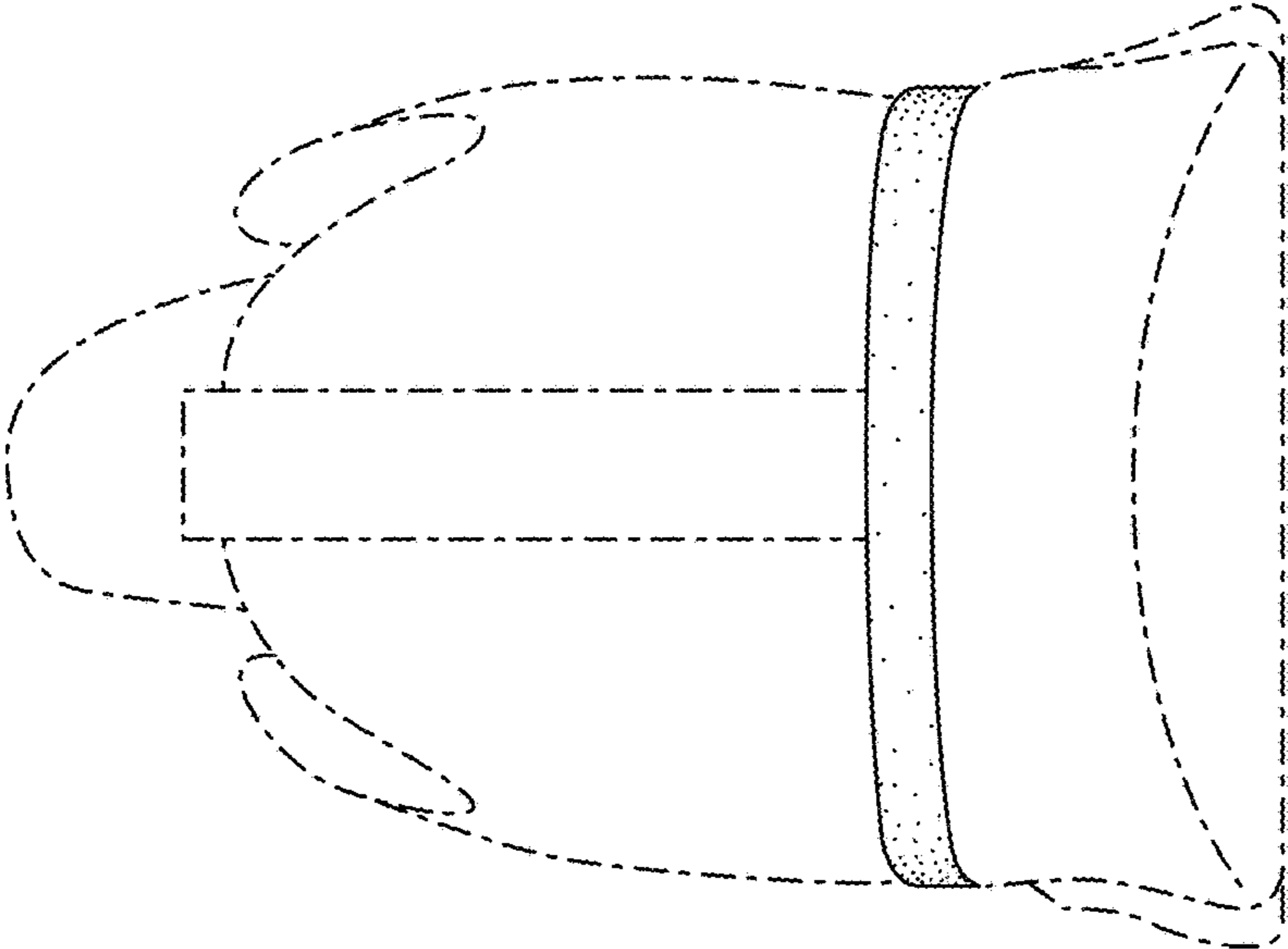

FIG. 3

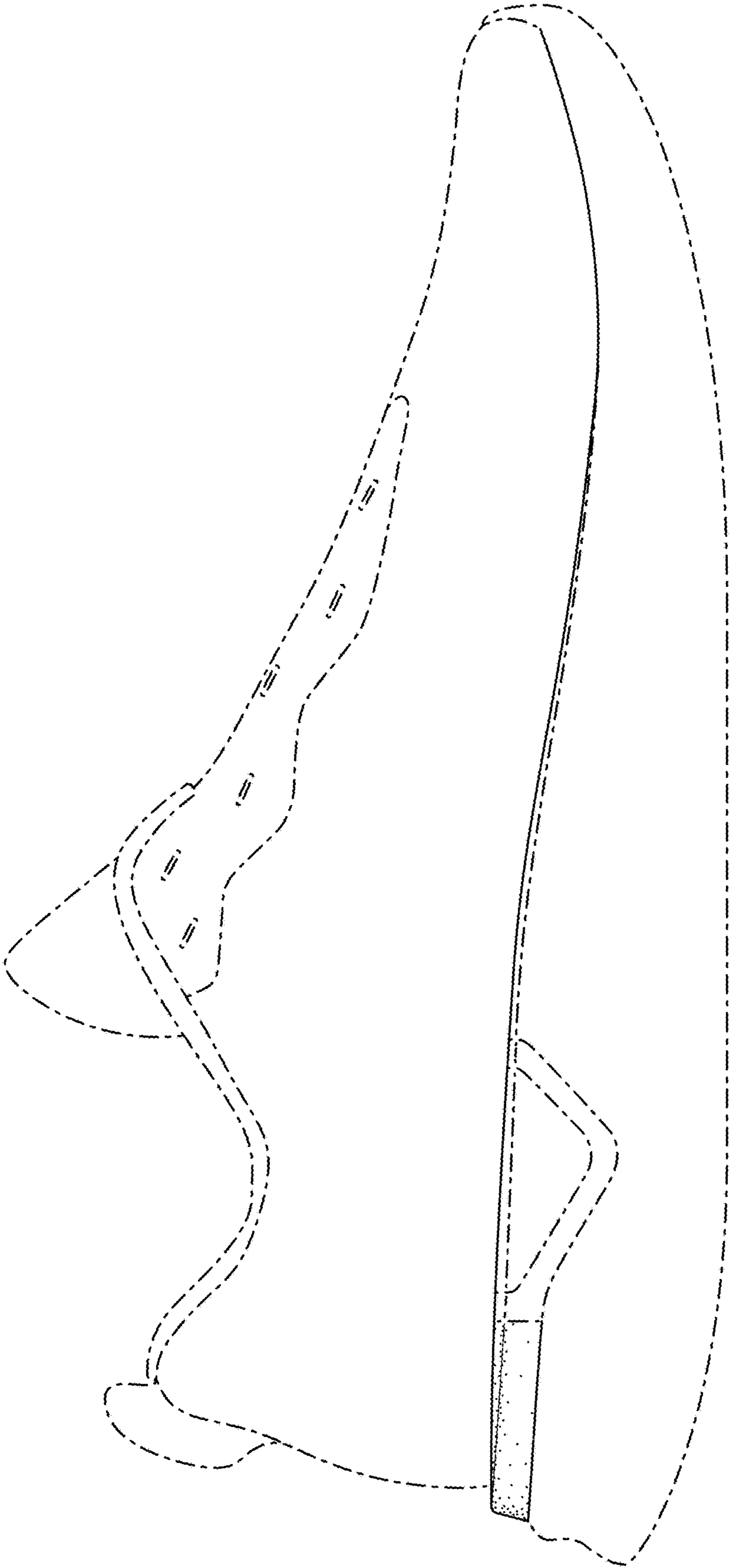

FIG. 4

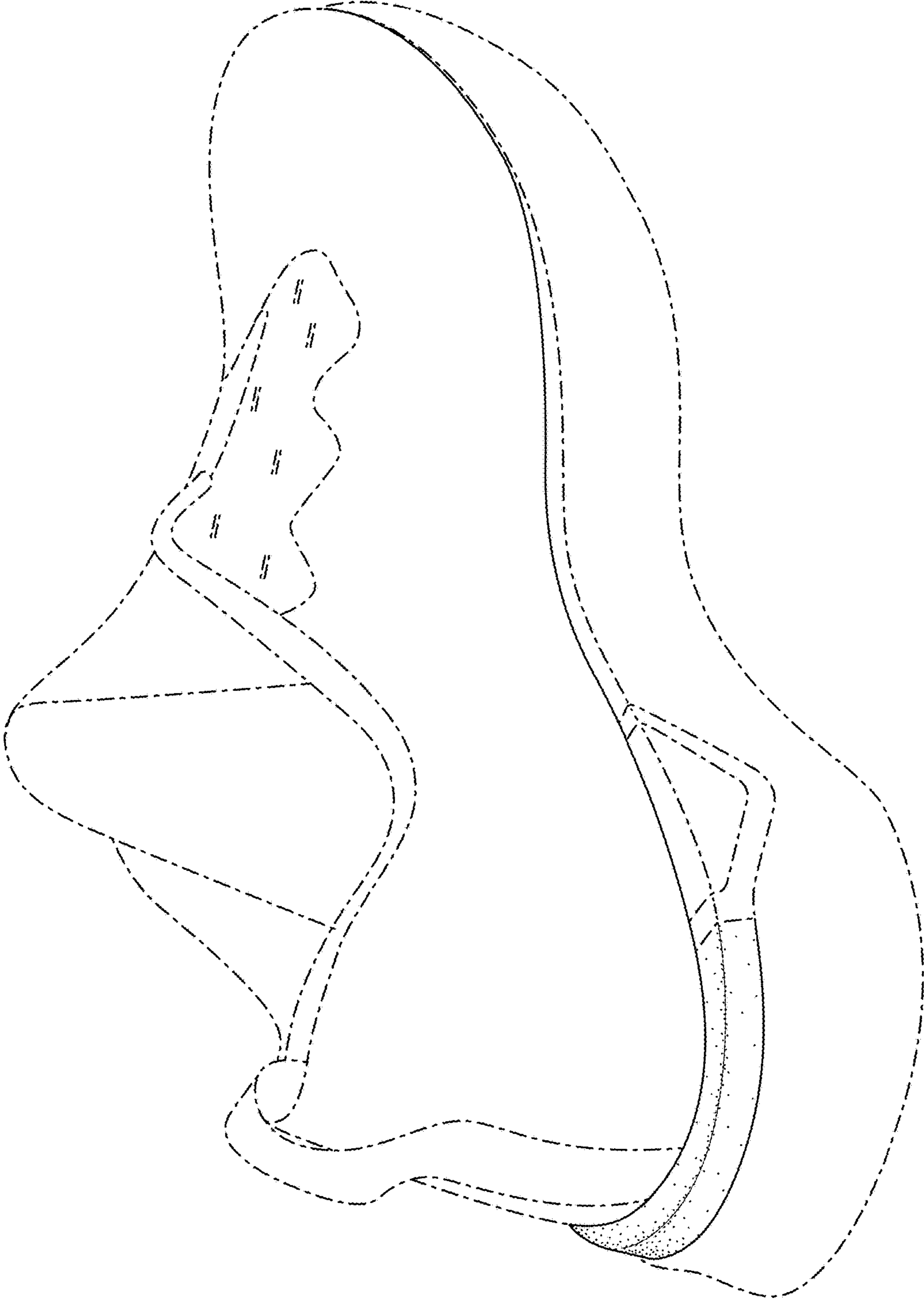

FIG. 5