



US00D819218S

(12) **United States Design Patent** (10) **Patent No.:** **US D819,218 S**  
**Inzer** (45) **Date of Patent:** **\*\* May 29, 2018**

(54) **JOINT SUPPORT WRAP**  
(71) Applicant: **Inzer Advance Designs, Inc.**,  
Longview, TX (US)  
(72) Inventor: **John Inzer**, Longview, TX (US)  
(73) Assignee: **Inzer Advance Designs, Inc.**,  
Longview, TX (US)  
(\*\*) Term: **15 Years**  
(21) Appl. No.: **29/569,170**  
(22) Filed: **Jun. 24, 2016**  
(51) **LOC (11) Cl.** ..... **24-04**  
(52) **U.S. Cl.**  
USPC ..... **D24/189**  
(58) **Field of Classification Search**  
USPC ..... D24/189-192  
CPC ..... A61F 13/023; A61F 13/0203; A61F  
13/0226; A61F 13/00068; A61F  
2013/00817; A61F 2013/00748; A61F  
2013/00868; A61F 13/0259; A61F  
2013/00174; A61F 13/0216; A61F  
13/022; A61F 13/511; A61F 13/085;  
A61F 2013/530007; A61F 2013/530496;  
A61F 2013/0091; A61F 13/533; A61F  
2013/15422; A61F 2013/5304; A61L  
15/58; A61L 15/26; A61L 15/60; A61L  
15/425  
See application file for complete search history.

(56) **References Cited**  
U.S. PATENT DOCUMENTS  
5,139,015 A 8/1992 Morneau  
5,807,292 A \* 9/1998 Delmore ..... A61F 13/04  
602/1  
D403,775 S 1/1999 Davis et al.  
6,358,220 B1 \* 3/2002 Langen ..... A61F 13/04  
602/5

6,595,938 B1 \* 7/2003 Delmore ..... A61F 13/04  
602/1  
D484,986 S 1/2004 Cipra et al.  
D503,806 S 4/2005 Williams  
7,549,967 B2 \* 6/2009 Elsner ..... A61F 13/04  
602/5  
D626,243 S 10/2010 Sagnip et al.  
D662,213 S 6/2012 Quisenberry  
9,011,305 B2 4/2015 Inzer  
D728,804 S \* 5/2015 Hansen ..... D24/190  
2006/0253058 A1 \* 11/2006 Evans ..... A61F 13/0273  
602/41  
2008/0287852 A1 \* 11/2008 Evans ..... A61F 13/041  
602/43

(Continued)

*Primary Examiner* — George D. Kirschbaum  
*Assistant Examiner* — Jennifer Watkins  
(74) *Attorney, Agent, or Firm* — Dinsmore & Shohl LLP

(57) **CLAIM**  
I claim the ornamental design for a joint support wrap, as shown and described.

**DESCRIPTION**

FIG. 1 is a front view of a joint support wrap illustrating my new design;  
FIG. 2 is a rear view thereof;  
FIG. 3 is a left side elevational view thereof, the right side elevational view is a mirror image of FIG. 3;  
FIG. 4 is a front end view thereof, the back end view is a mirror image of FIG. 4;  
FIG. 5 is an enlarged front view showing detail of the ornamental aspects of the design; and,  
FIG. 6 is an enlarged rear view showing detail of the ornamental aspects of the design.  
The broken lines in FIGS. 1 and 2 are for the purpose of illustrating the cut lines of the enlarged views of FIGS. 5 and 6, respectively. Broken lines in the drawings represent portions of the joint support wrap that form no part of the claimed design.

**1 Claim, 3 Drawing Sheets**

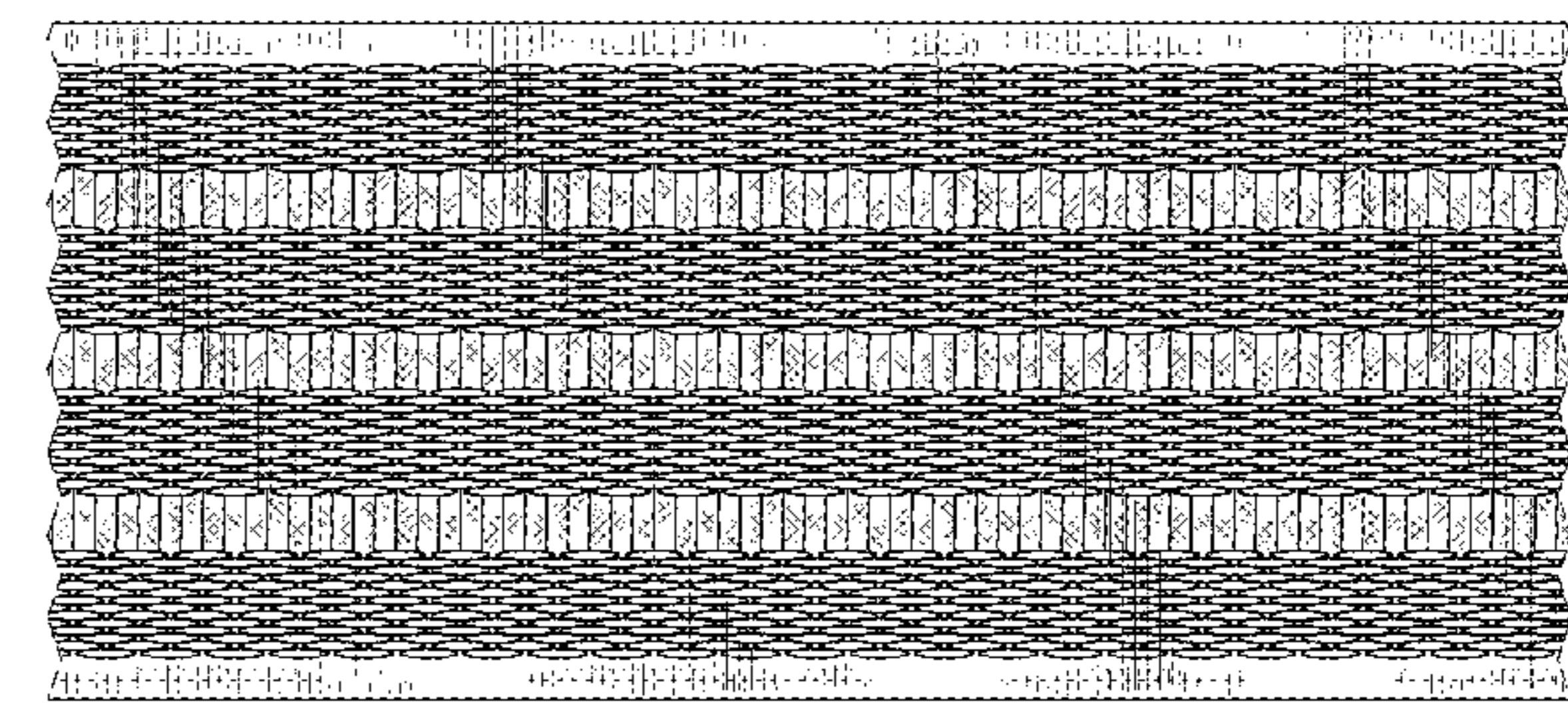
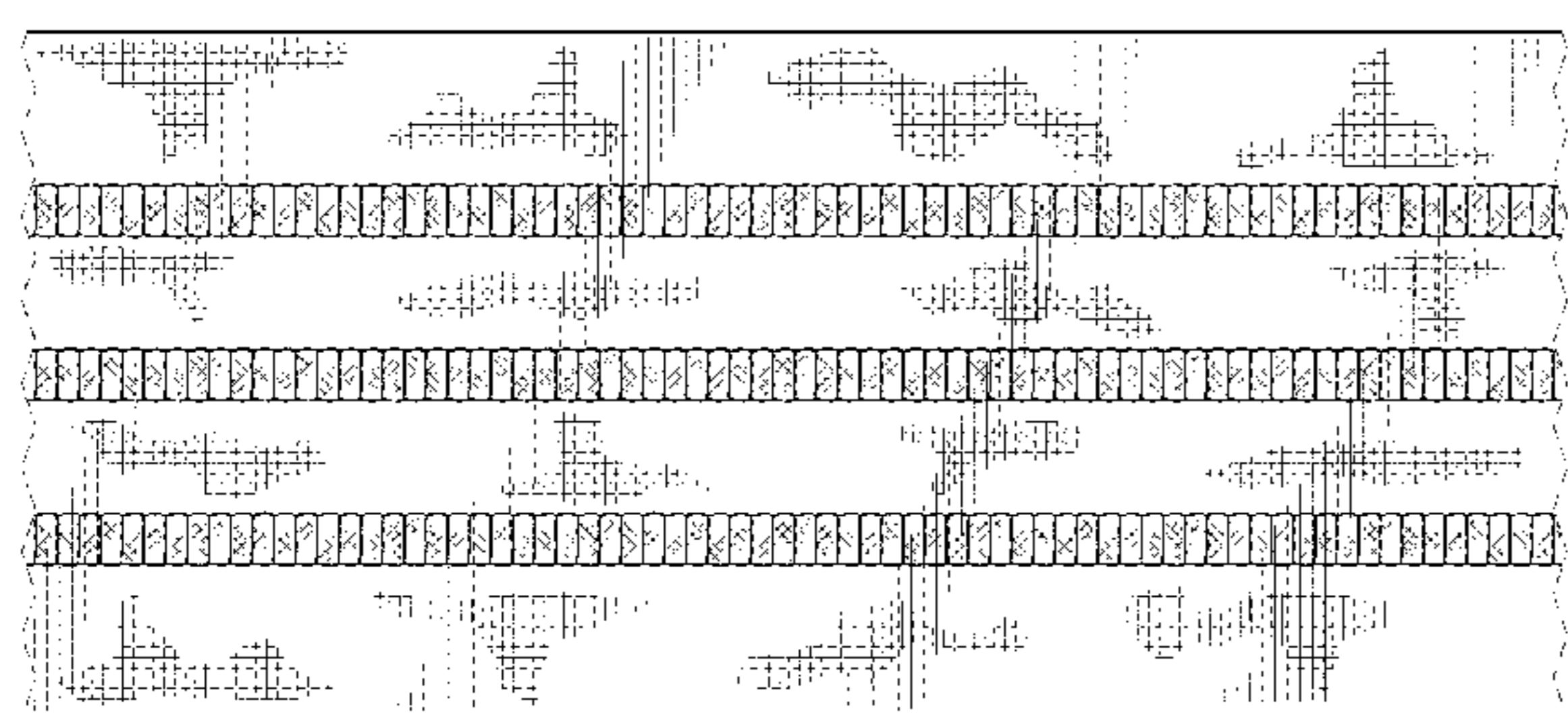

(56)

**References Cited**

U.S. PATENT DOCUMENTS

2009/0043232 A1\* 2/2009 Borschneck ..... A61F 5/0125  
602/5  
2009/0177137 A1\* 7/2009 Evans ..... A61F 13/041  
602/60  
2011/0112453 A1\* 5/2011 Petiot ..... A61F 5/028  
602/19  
2013/0131565 A1\* 5/2013 Dallafor ..... A61F 5/01  
602/5  
2013/0172156 A1\* 7/2013 Inzer ..... A63B 71/1225  
482/93  
2014/0330232 A1\* 11/2014 Schonbeck ..... A61F 13/15699  
604/365  
2016/0158075 A1\* 6/2016 Sheldon ..... A61F 13/5323  
604/382  
2016/0347030 A1\* 12/2016 Yamada ..... B32B 5/022

\* cited by examiner

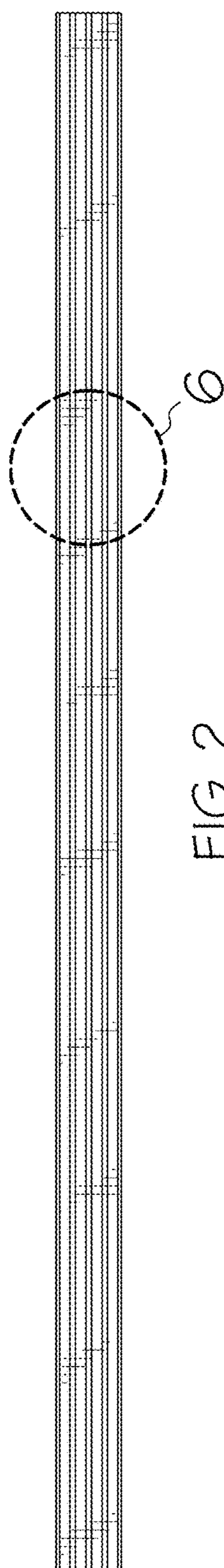
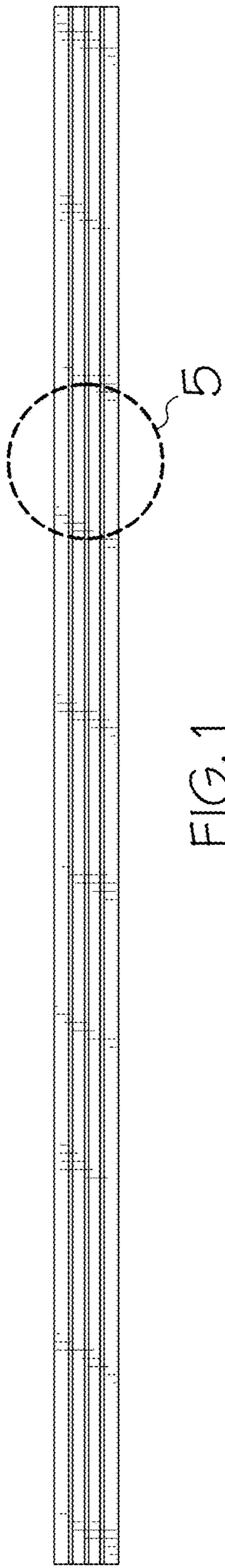

FIG. 3

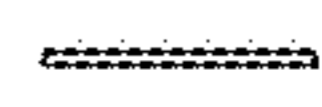

FIG. 4

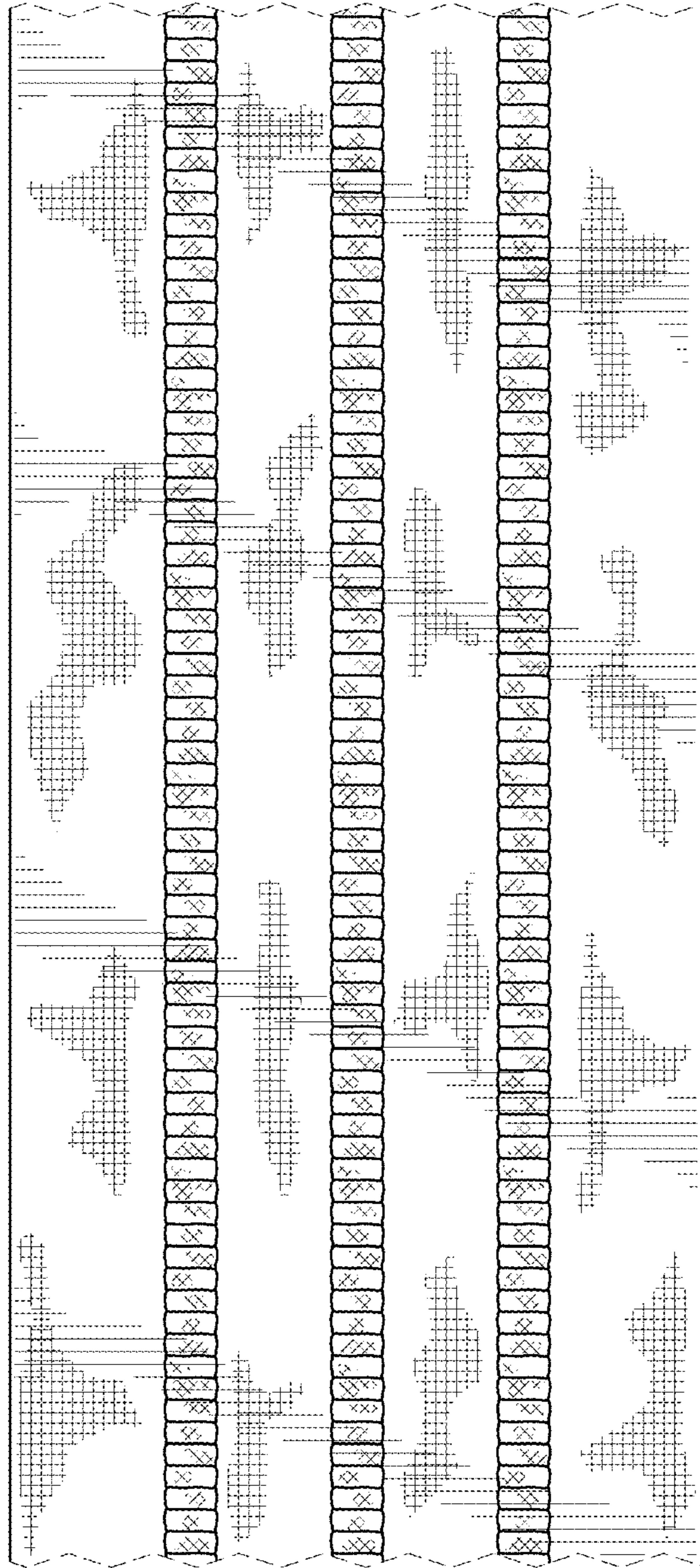

FIG. 5

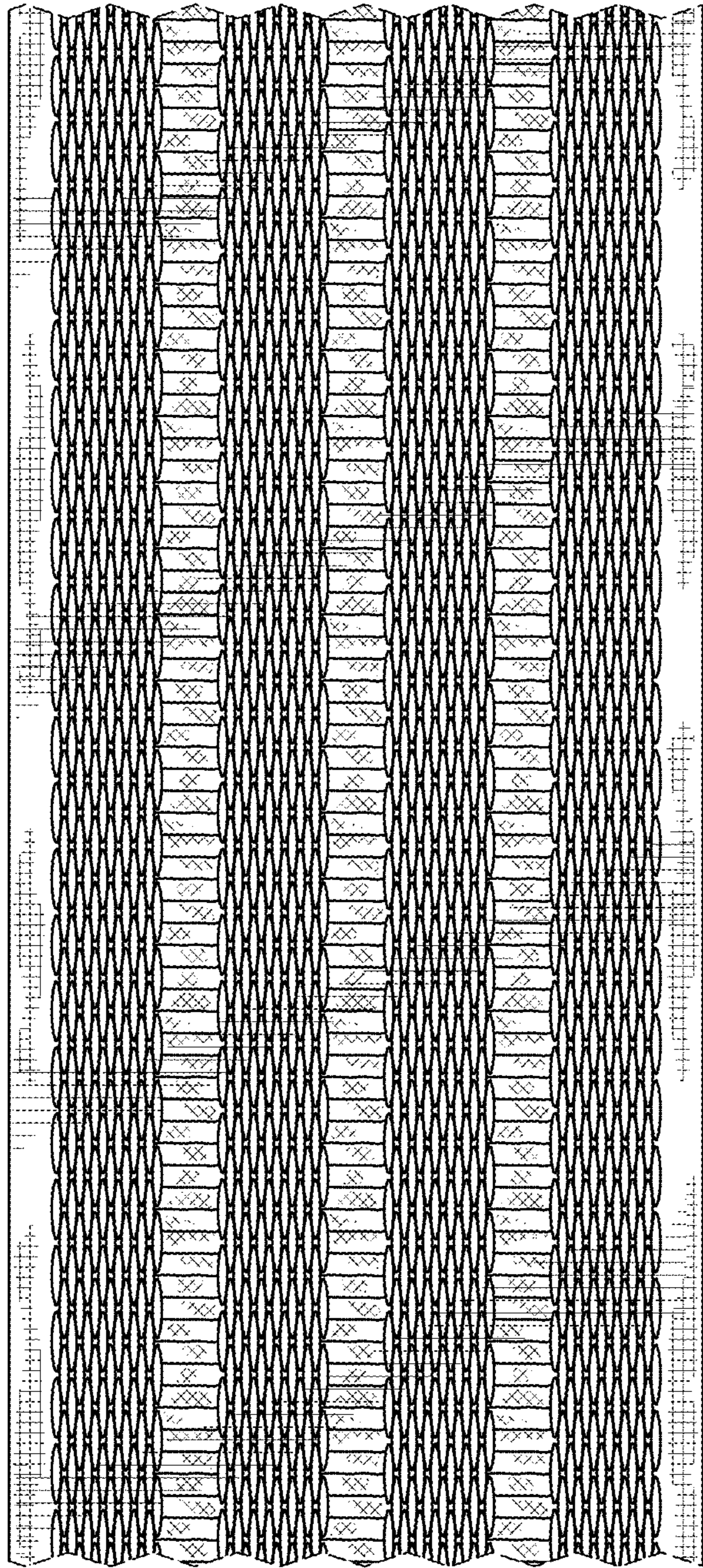

FIG. 6