



US00D819205S

(12) **United States Design Patent** (10) **Patent No.:** **US D819,205 S**  
**Snyder** (45) **Date of Patent:** **\*\* May 29, 2018**

(54) **NASAL DILATOR**

FOREIGN PATENT DOCUMENTS

(71) Applicant: **Raymond Snyder**, Leawood, KS (US)

CA 2952261 A1 \* 12/2015 ..... A61M 29/00  
WO WO 2011104660 A2 \* 9/2011 ..... A61F 5/08

(72) Inventor: **Raymond Snyder**, Leawood, KS (US)

(73) Assignee: **Tru-Breathe, Inc.**, Leawood, KS (US)

(\*\*) Term: **15 Years**

(21) Appl. No.: **29/563,545**

(22) Filed: **May 5, 2016**

(51) **LOC (11) Cl.** ..... **24-02**

(52) **U.S. Cl.**

USPC ..... **D24/135**

(58) **Field of Classification Search**

USPC ..... D24/133, 135, 136, 189

CPC ..... A61F 5/08; A61B 17/0057; A61B 1/233;

A61M 29/00; A61M 29/02

See application file for complete search history.

(56) **References Cited**

U.S. PATENT DOCUMENTS

855,573	A *	6/1907	Heath	.....	A61M 16/0666
					128/206.11
D422,080	S *	3/2000	Vincent	.....	D24/135
D430,667	S *	9/2000	Rome	.....	D24/135
D436,666	S *	1/2001	Hammerlund	.....	D24/176
D438,967	S *	3/2001	Alpers	.....	D24/135
D575,397	S *	8/2008	Noce	.....	D24/135
D652,143	S *	1/2012	Brown	.....	D24/135
D652,518	S *	1/2012	Jensen	.....	D24/135
D670,382	S *	11/2012	Noce	.....	D24/135
D713,031	S *	9/2014	McCormick	.....	D24/135
D753,821	S *	4/2016	Pepper	.....	D24/135
D754,850	S *	4/2016	Pepper	.....	D24/135
D788,913	S *	6/2017	Pepper	.....	D24/135

OTHER PUBLICATIONS

Amazon. <URL: [https://www.amazon.com/WoodyKnows-Anti-Snoring-Solution-Breathing-Alternatives/dp/B00DLYR4MY/ref=pd\\_sim\\_121\\_12?\\_encoding=UTF8&pd\\_rd\\_i=B00DLYR4MY&pd\\_rd\\_r=7AV5TA4RJ0QVWYFPMJ0V&pd\\_rd\\_w=0mAdW&pd\\_rd\\_wg=xqUWO&refRID=7AV5TA4RJ0QVWYFPMJ0V&th=1](https://www.amazon.com/WoodyKnows-Anti-Snoring-Solution-Breathing-Alternatives/dp/B00DLYR4MY/ref=pd_sim_121_12?_encoding=UTF8&pd_rd_i=B00DLYR4MY&pd_rd_r=7AV5TA4RJ0QVWYFPMJ0V&pd_rd_w=0mAdW&pd_rd_wg=xqUWO&refRID=7AV5TA4RJ0QVWYFPMJ0V&th=1)> Mar. 7, 2014. Nasal dilator.\*  
Breathe Right Nasal Strips, <https://www.breatheright.com>, accessed Jul. 13, 2016.

\* cited by examiner

*Primary Examiner* — Bridget L Eland

*Assistant Examiner* — Lauren McVey

(74) *Attorney, Agent, or Firm* — Lathrop Gage L.L.P.

(57) **CLAIM**

The ornamental design for a nasal dilator, as shown and described.

**DESCRIPTION**

FIG. 1 is a perspective view of a nasal dilator, showing my new design;

FIG. 2 is a top plan view thereof;

FIG. 3 is a bottom plan view thereof;

FIG. 4 is a left side elevation view thereof;

FIG. 5 is a right side elevation view thereof;

FIG. 6 is a rear elevation view thereof;

FIG. 7 is a front elevation view thereof; and,

FIG. 8 is another perspective view of the nasal dilator of FIG. 1, shown with environment.

The broken lines are directed to environment; the broken lines form no part of the claimed design.

**1 Claim, 5 Drawing Sheets**

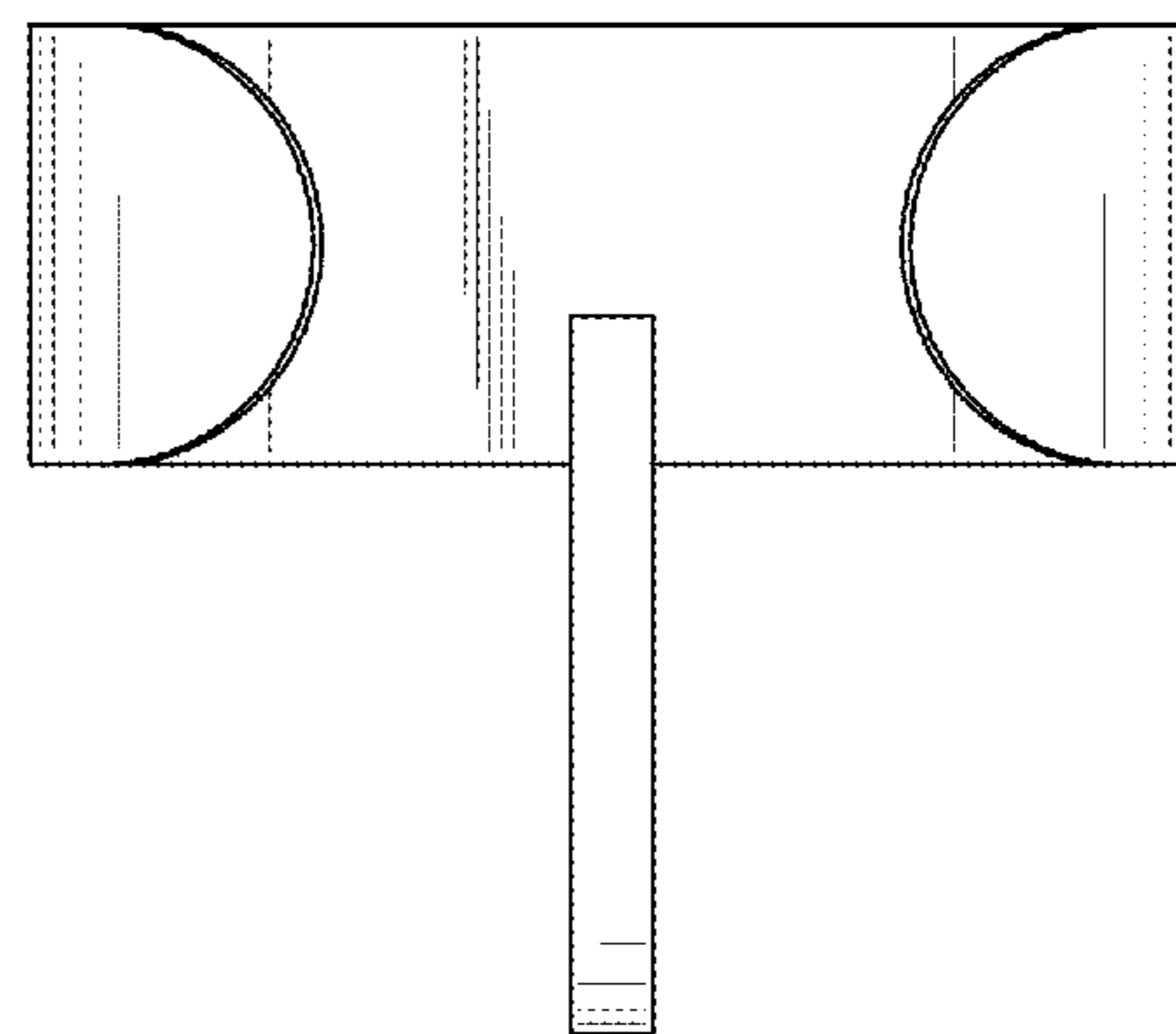
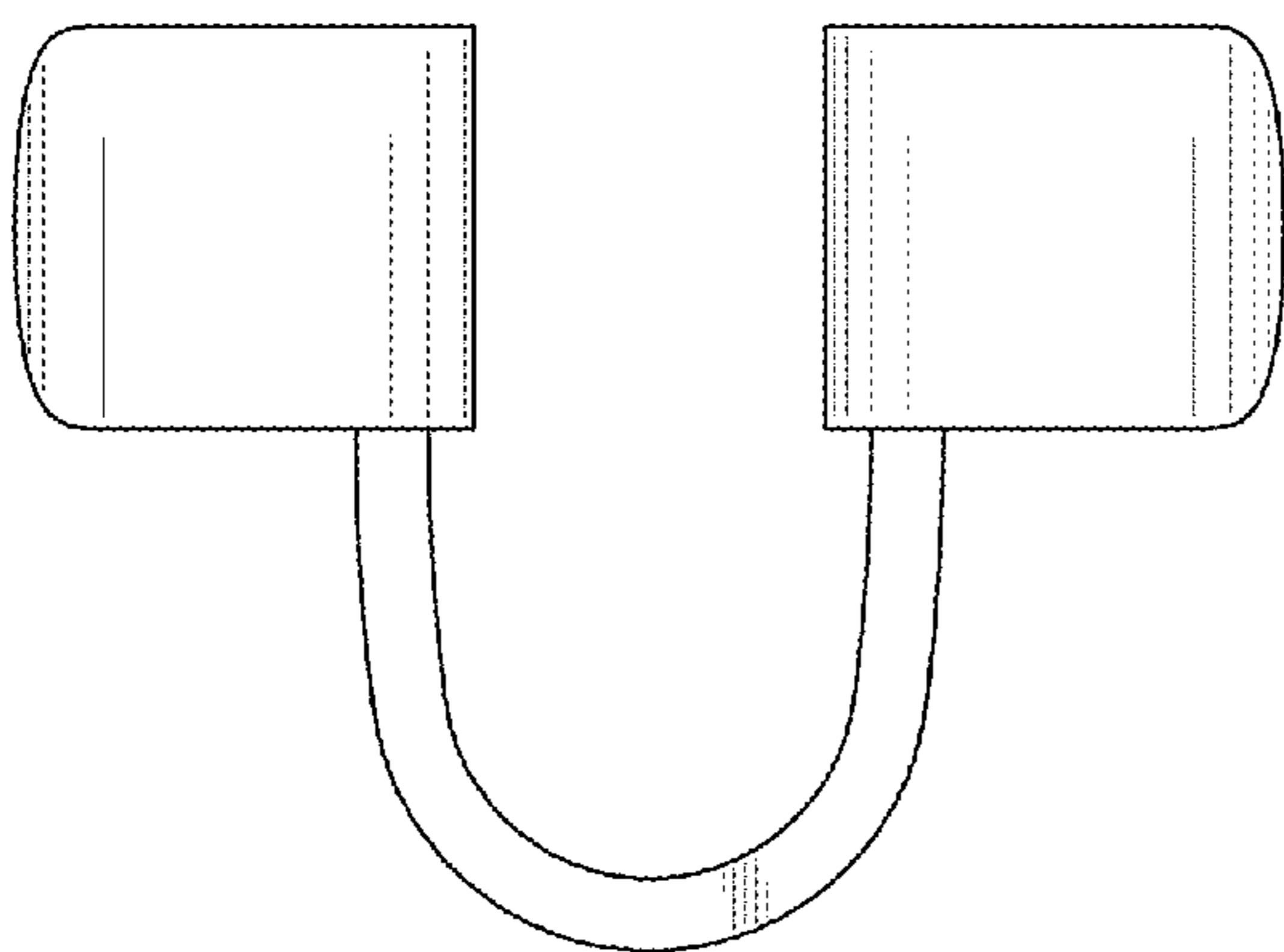

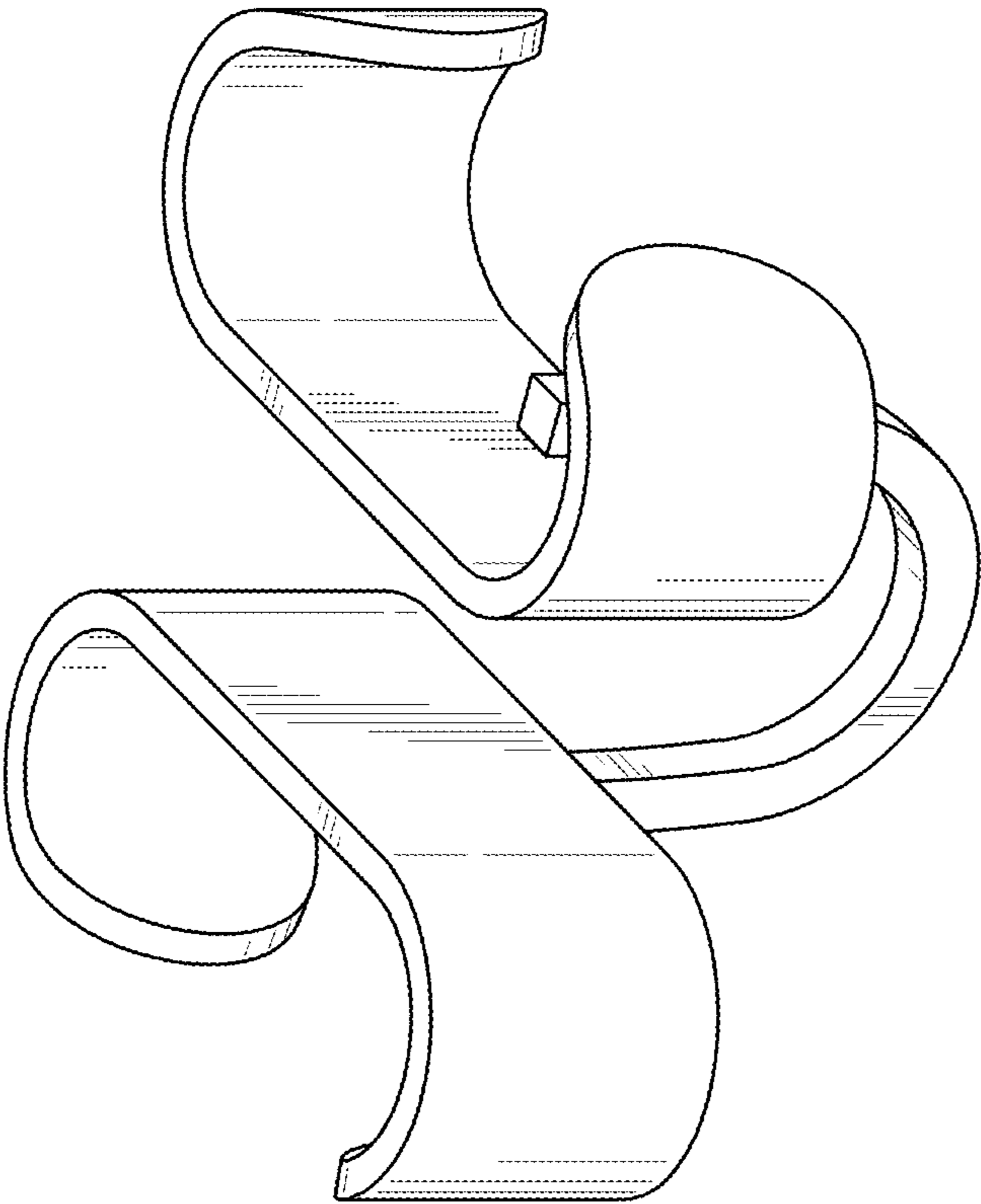

FIG. 1

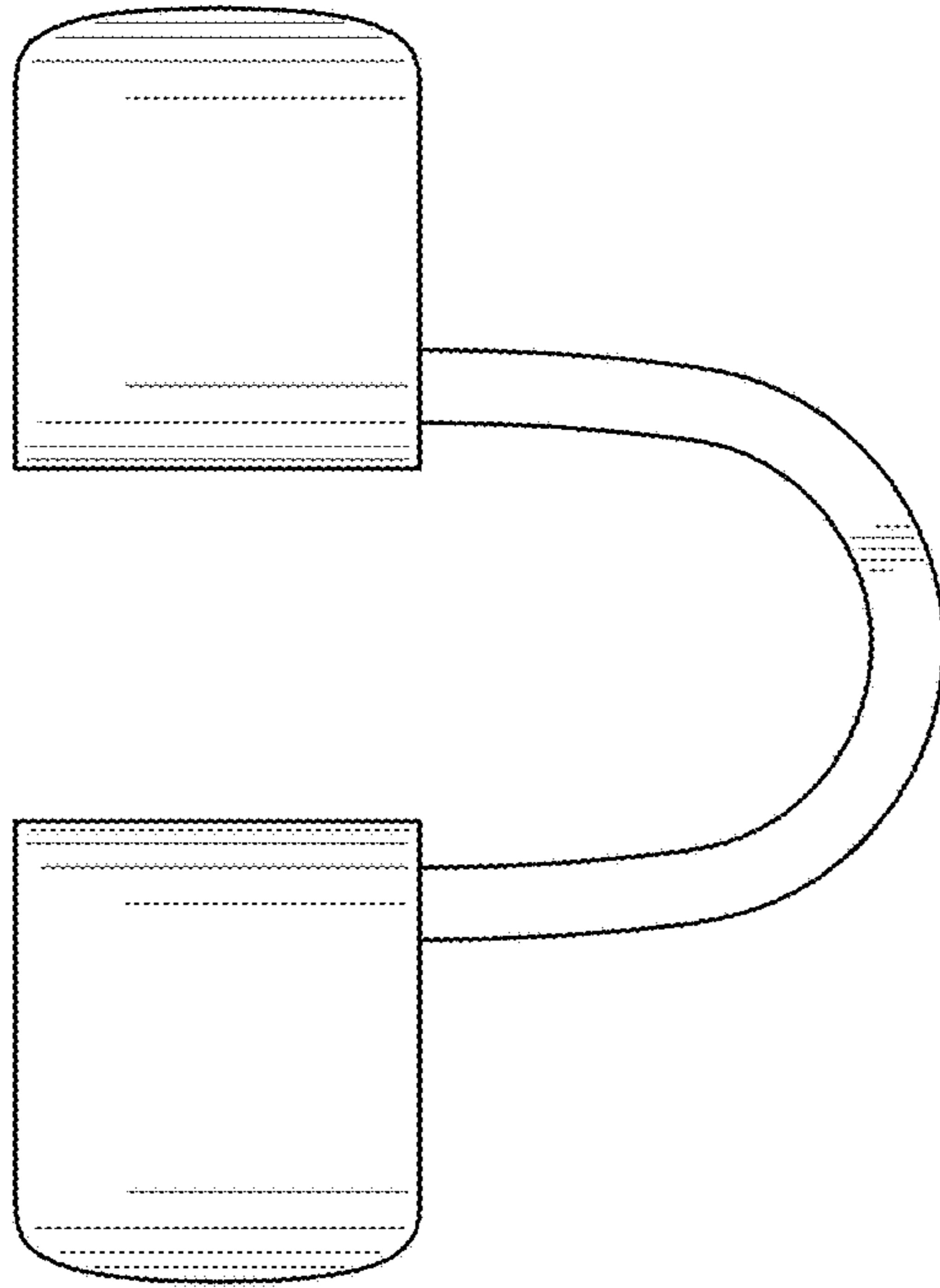

FIG. 3

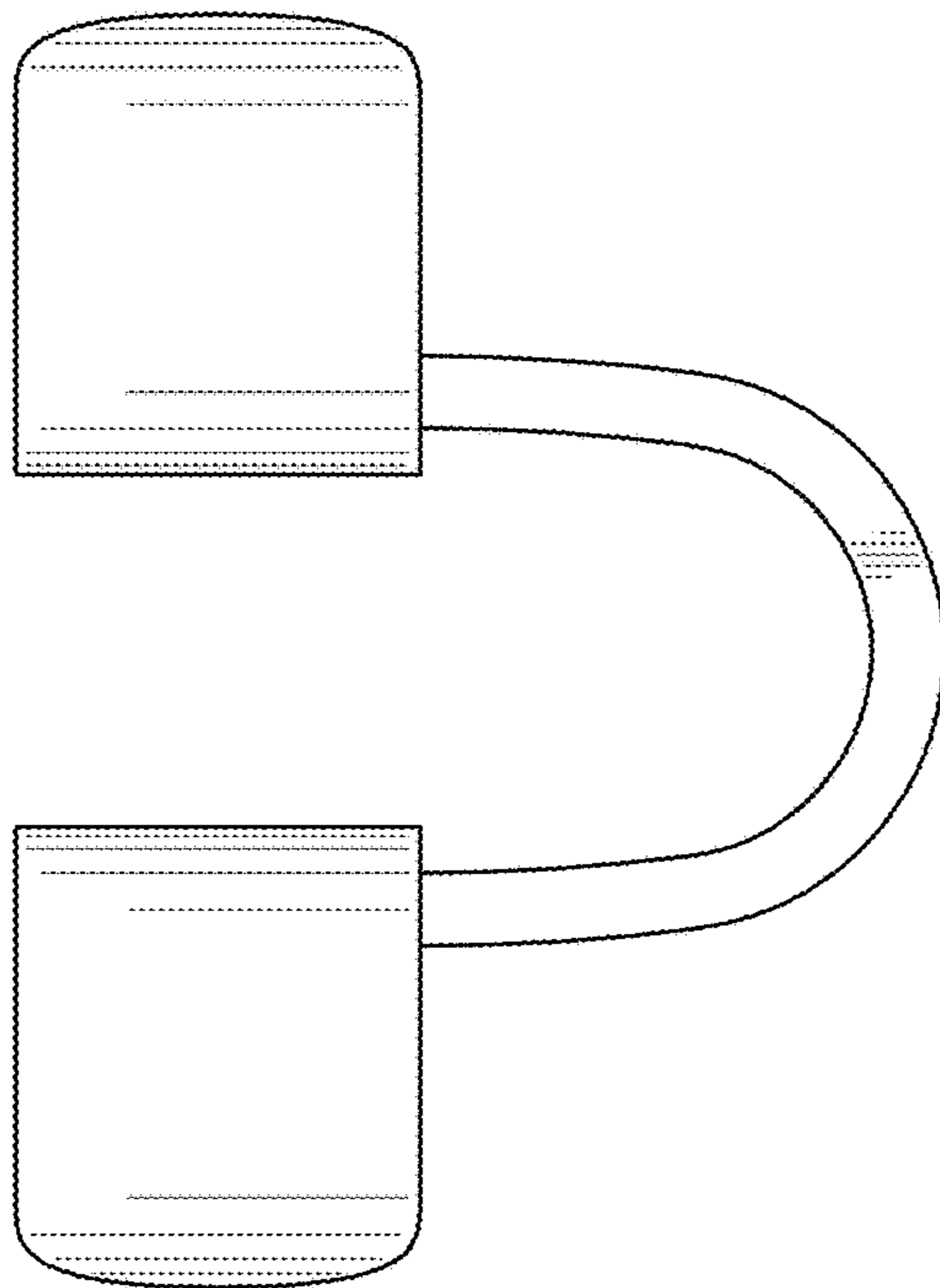

FIG. 2

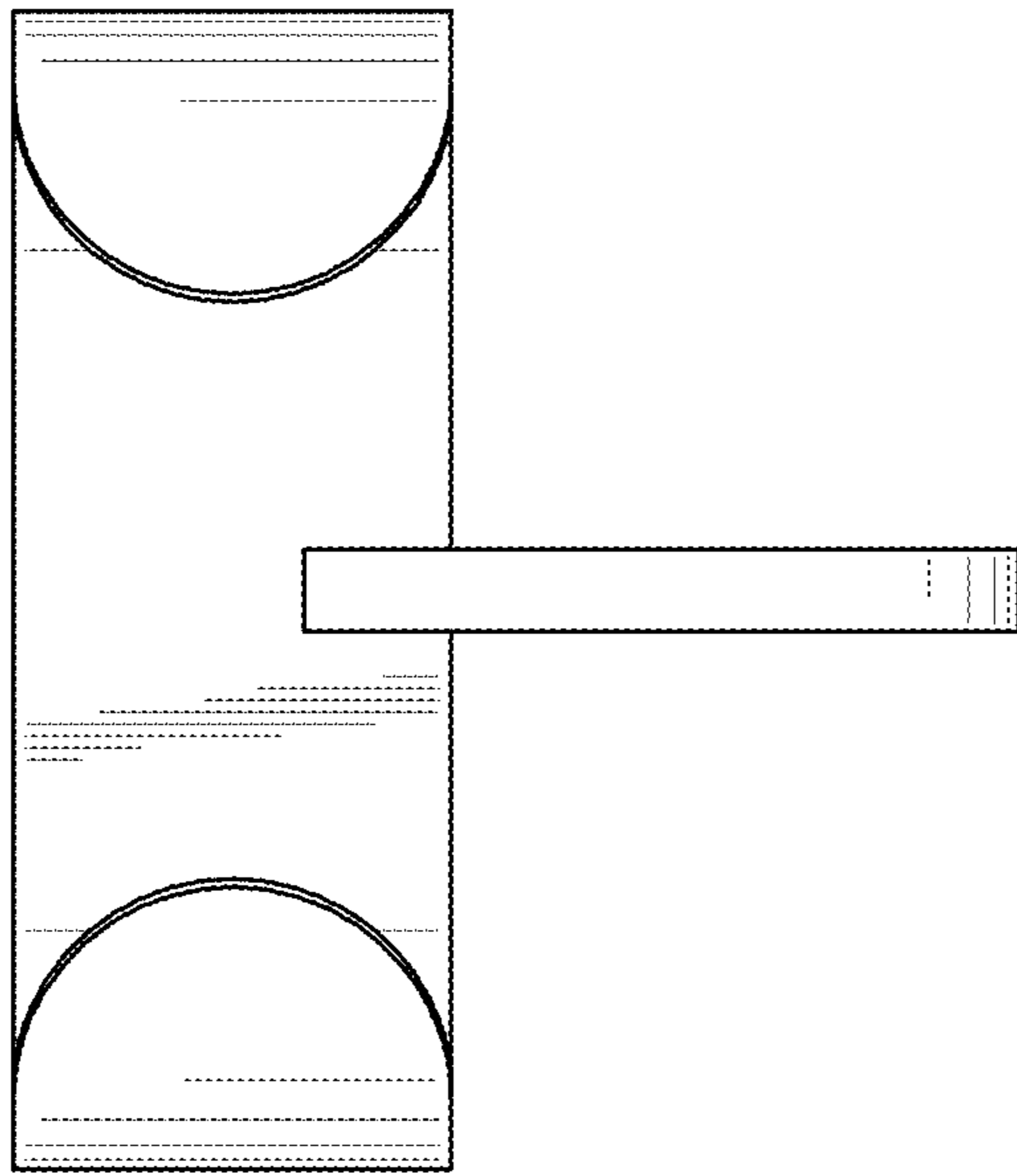

FIG. 5

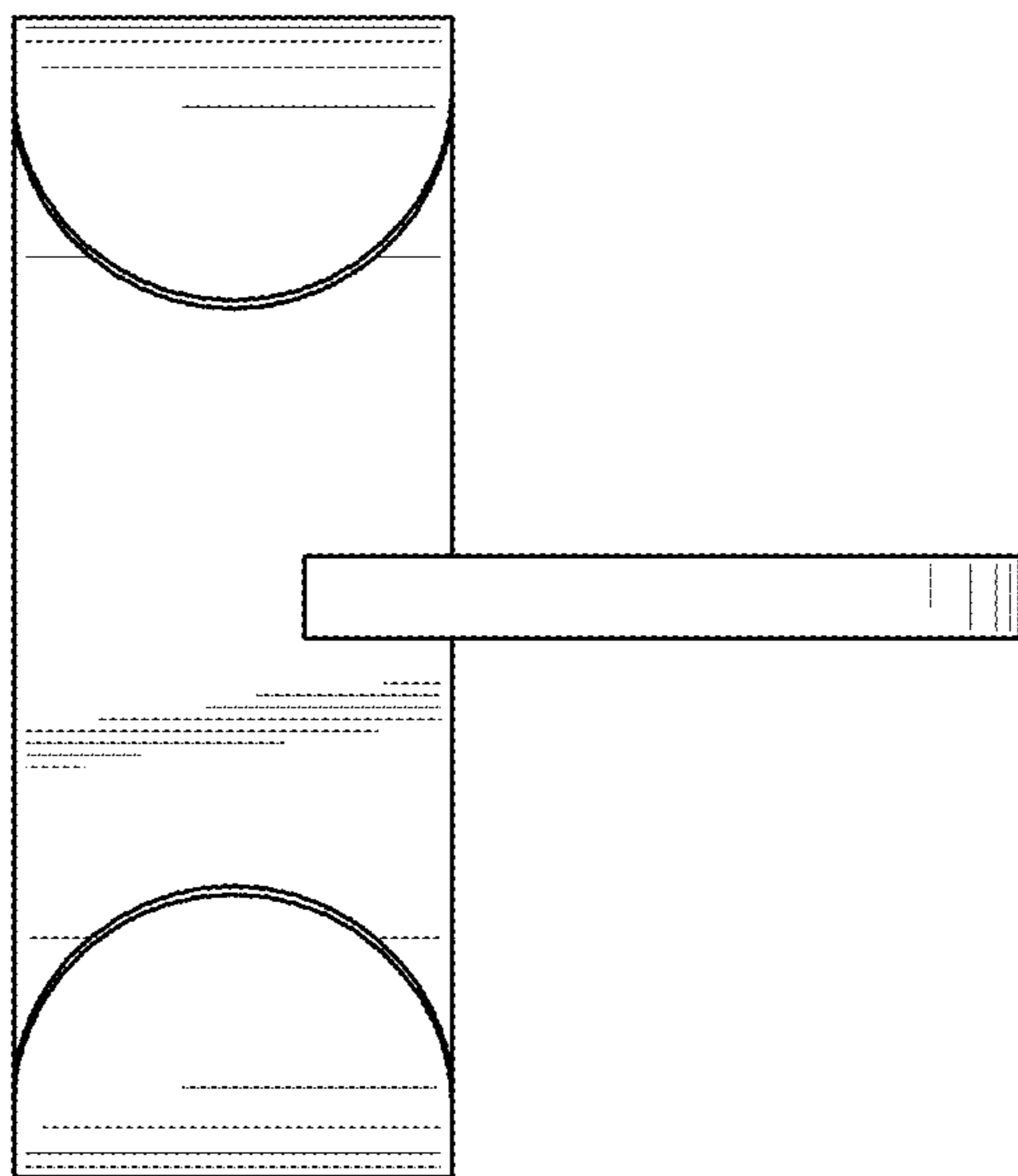

FIG. 4

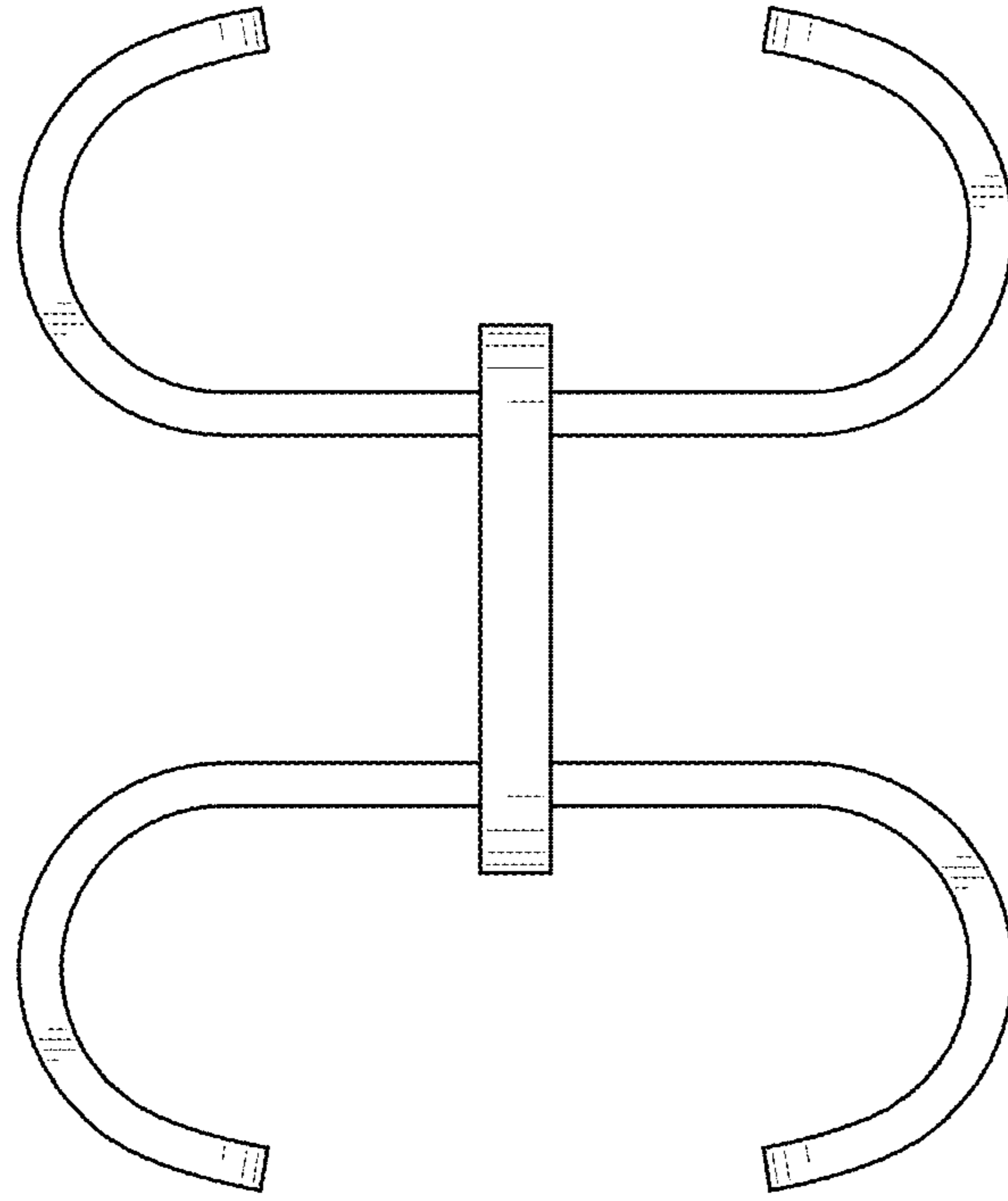

FIG. 7

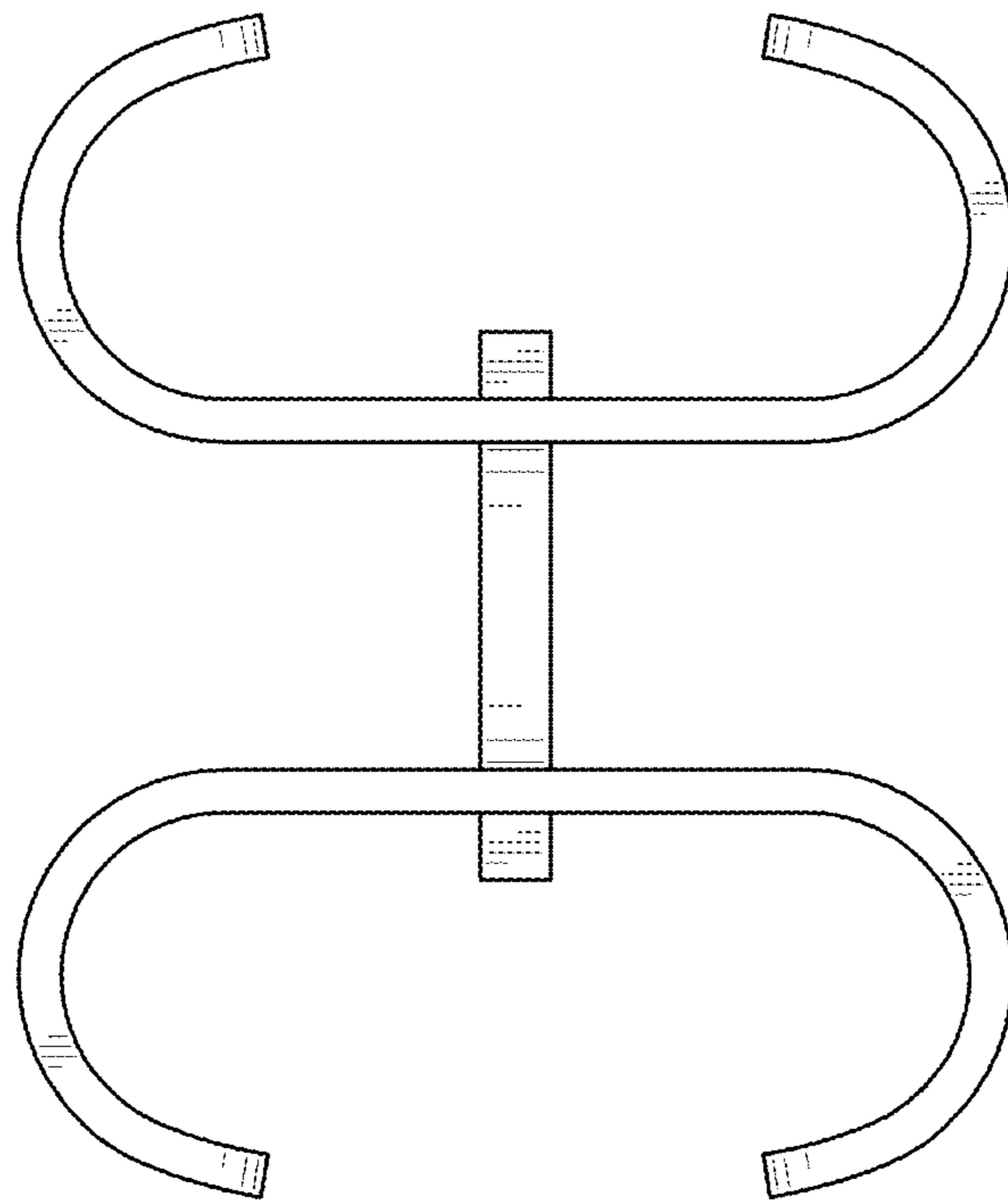

FIG. 6

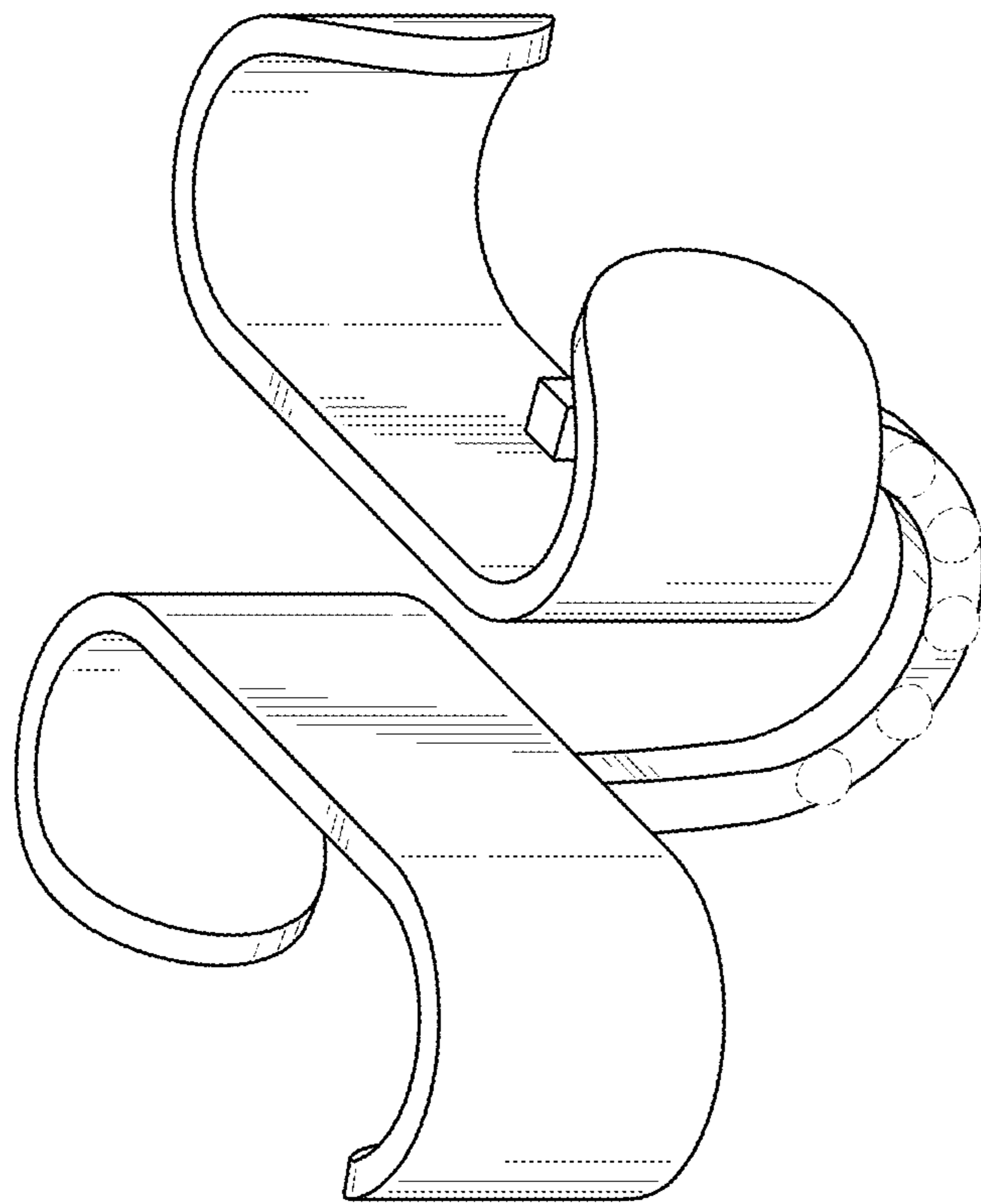

FIG. 8