



US00D819091S

(12) **United States Design Patent** (10) **Patent No.:** **US D819,091 S**
Neill et al. (45) **Date of Patent:** **** May 29, 2018**

(54) **REFRIGERATED EQUIPMENT STAND**

(71) Applicant: **Hoshizaki America, Inc.**, Peachtree City, GA (US)

(72) Inventors: **Jeremy Neill**, Gay, GA (US); **Kevin Huckaby**, Newnan, GA (US); **Rodrick Smalls**, Griffin, GA (US)

(73) Assignee: **Hoshizaki America, Inc.**, Peachtree City, GA (US)

(**) Term: **15 Years**

(21) Appl. No.: **29/591,374**

(22) Filed: **Jan. 19, 2017**

(51) **LOC (11) Cl.** **15-07**

(52) **U.S. Cl.**
USPC **D15/81**

(58) **Field of Classification Search**
USPC D15/79-91; D34/12-27
CPC F25D 23/028; F25D 27/00; F25D 27/005;
F25D 23/062; F25D 23/065; F25D
2323/021; F25D 2323/024; F25D
2327/001; F25D 23/067; F25D 2400/40;
F25D 25/024; F25D 11/00; F25D 11/003;
F25D 15/00; F25D 17/02; F25D 21/04;
F25D 2201/12; F25D 2303/081; F25D
2323/02; F25D 2323/023; F25D 2323/06;
F25D 2323/061; F25D 2323/121; F25D
2325/021; F25D 2325/022; F25D
2331/803; F25D 2331/805; F25D 23/006;
F25D 23/02; F25D 23/06; F25D 23/061;
F25D 23/066; F25D 23/068; F25D 23/08;
F25D 23/126; F25D 2400/04; F25D
2400/28; F25D 2400/32; F25D 2400/36;
F25D 25/02; F25D 25/025; F25D
2700/02; F25D 2700/04; F25D 2700/06;
F25D 2700/16; F25D 29/00; F25D
29/008; F25D 31/002; F25D 31/005;
F25D 31/007; F25D 3/08

See application file for complete search history.

(56) **References Cited**

U.S. PATENT DOCUMENTS

D256,587 S *	8/1980	Tatsumi	D15/83
D368,916 S *	4/1996	Pawlowski	D15/79
D523,607 S *	6/2006	Huguet	D34/21
D535,452 S *	1/2007	Lim	D34/19
D551,259 S *	9/2007	Wilson	D15/79
D566,140 S *	4/2008	Ikeda	D15/79
D596,651 S *	7/2009	Li	D15/79
D598,622 S *	8/2009	Wise	D34/19
D598,623 S *	8/2009	Zang Wentz Pho	D34/20

(Continued)

OTHER PUBLICATIONS

Delfield; Brochure for Equipment Stands, Copyright 2014, 4 pgs.

(Continued)

Primary Examiner — Ian Simmons

Assistant Examiner — Khawaja Anwar

(74) *Attorney, Agent, or Firm* — Taylor English Duma LLP

(57) **CLAIM**

We claim the ornamental design for a refrigerated equipment stand, as shown and described.

DESCRIPTION

FIG. 1 is a perspective view of the claimed design.

FIG. 2 is a front elevation view thereof.

FIG. 3 is a rear elevation view thereof.

FIG. 4 is a left-side elevation view thereof.

FIG. 5 is a right-side elevation view thereof.

FIG. 6 is a top plan view thereof; and,

FIG. 7 is a bottom plan view thereof.

The invention pertains to an ornamental design for a refrigerated equipment stand. The solid lines represent the bounds of the claimed design, whereas those features shown in broken lines form no part of the claimed design.

1 Claim, 7 Drawing Sheets

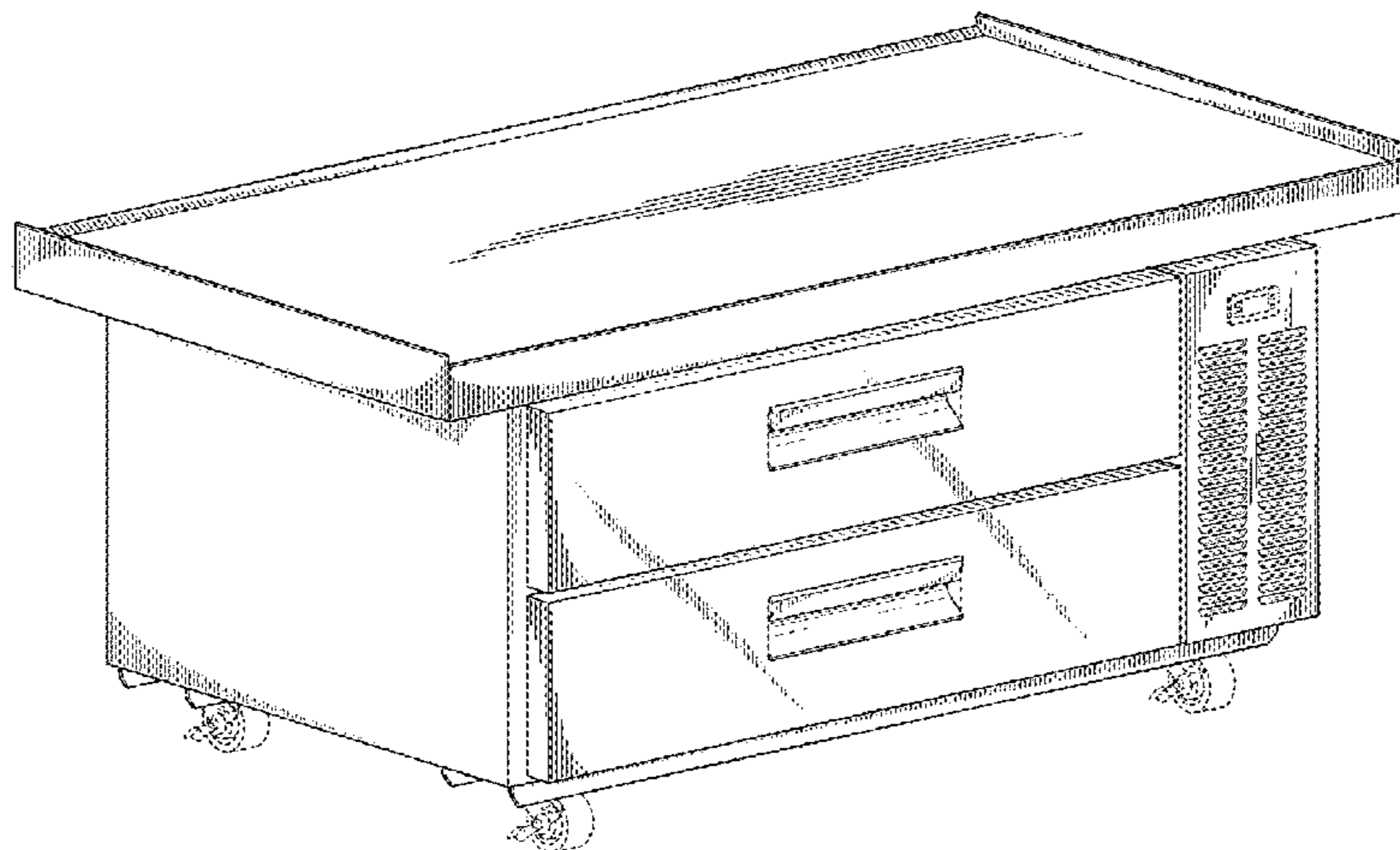

(56)

References Cited

U.S. PATENT DOCUMENTS

D621,569 S	*	8/2010	Linnell, Jr.	D34/19
D672,793 S	*	12/2012	Tang	D15/83
D707,912 S	*	6/2014	Koehler	D34/19
D771,157 S	*	11/2016	Yamada	D15/81
D771,158 S	*	11/2016	Jain	D15/81
D802,029 S	*	11/2017	Li	D15/81

OTHER PUBLICATIONS

Hoshizaki America, Inc.; Product Announcement for CRES72, published Jun. 2, 2015, 7 pgs.

Hoshizaki America, Inc.; Specification Sheet for CRES85—Commercial Series Low-Profile Refrigerated Equipment Stand, describing a product that was disclosed to the public prior to Jan. 19, 2016, 2 pgs.

Hoshizaki America, Inc.; Specification Sheet for CRES98—Commercial Series Low-Profile Refrigerated Equipment Stand, describing a product that was disclosed to the public prior to Jan. 19, 2016, 2 pgs.

Hoshizaki; News Release for CRES49 Refrigerated Equipment Stand, published on Jun. 30, 2015, 5 pgs.

Hoshizaki; News Release for CRES72 Refrigerated Equipment Stand, published Jun. 2, 2015, 2 pgs.

Hoshizaki; News Release for CRES85—Refrigerated Equipment Stand, published on Jan. 18, 2016, 5 pgs.

Hoshizaki; News Release for CRES98—Refrigerated Equipment Stand, published on Dec. 2, 2015, 5 pgs.

Hoshizaki; Specification Sheet for CRES49—Commercial Series Low-Profile Refrigerated Equipment Stand, describing a product that was disclosed to the public prior to Jan. 19, 2016, 2 pgs.

Hoshizaki; Specification Sheet for CRES72—Commercial Series Low-Profile Refrigerated Equipment Stand, describing a product that was disclosed to the public prior to Jan. 19, 2016, 2 pgs.

Maxx Cold; Specification Sheet for Chef Base Units, publicly available prior to Jan. 19, 2017, 2 pgs.

True; Specification Sheet for TRCB-72 Chef Base, publicly available prior to Jan. 19, 2017, 2 pgs.

Turbo Air; Specification Sheet for TCBE-36 Chef Base, publicly available prior to Jan. 19, 2017, 2 pgs.

* cited by examiner

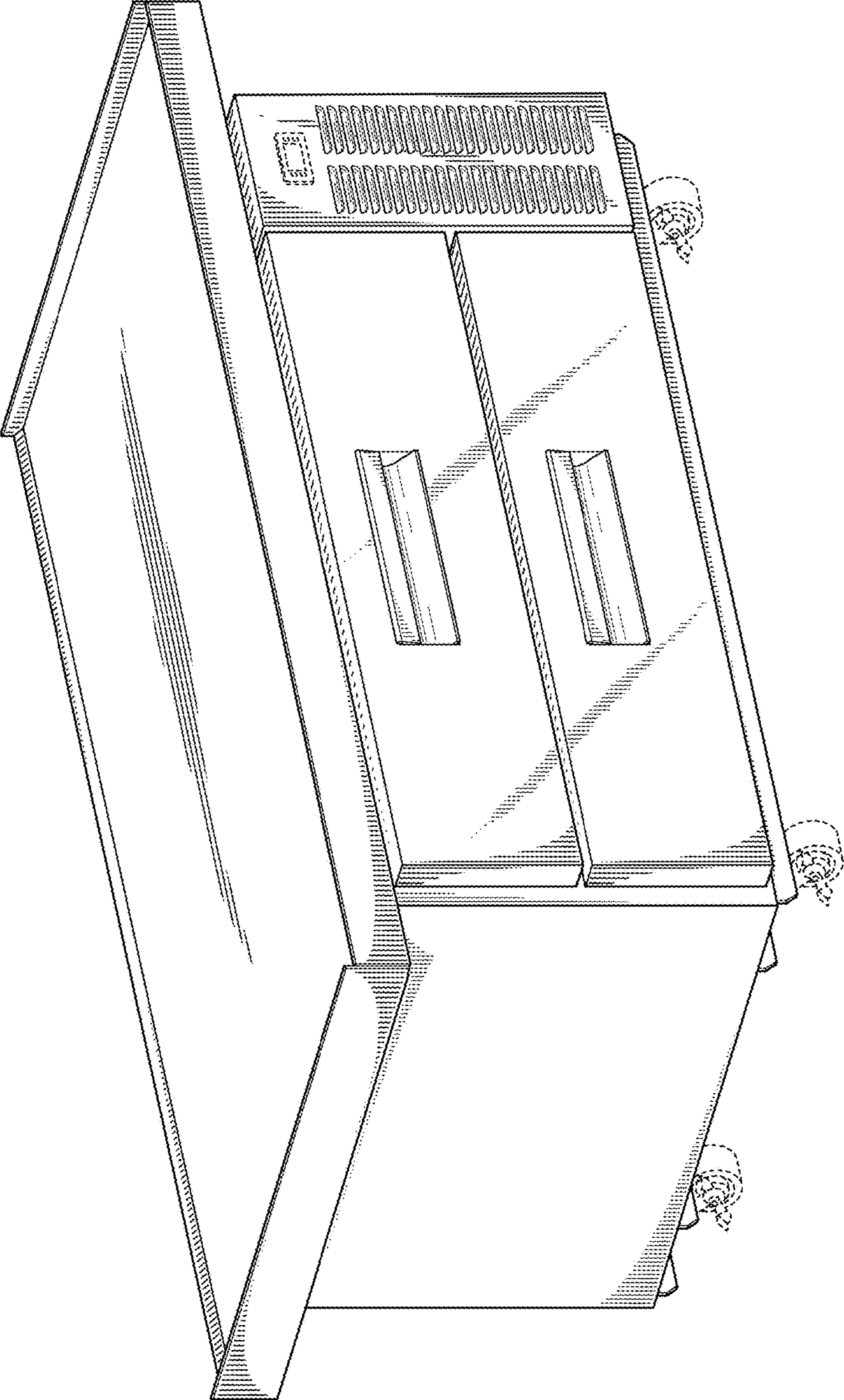

FIG. 1

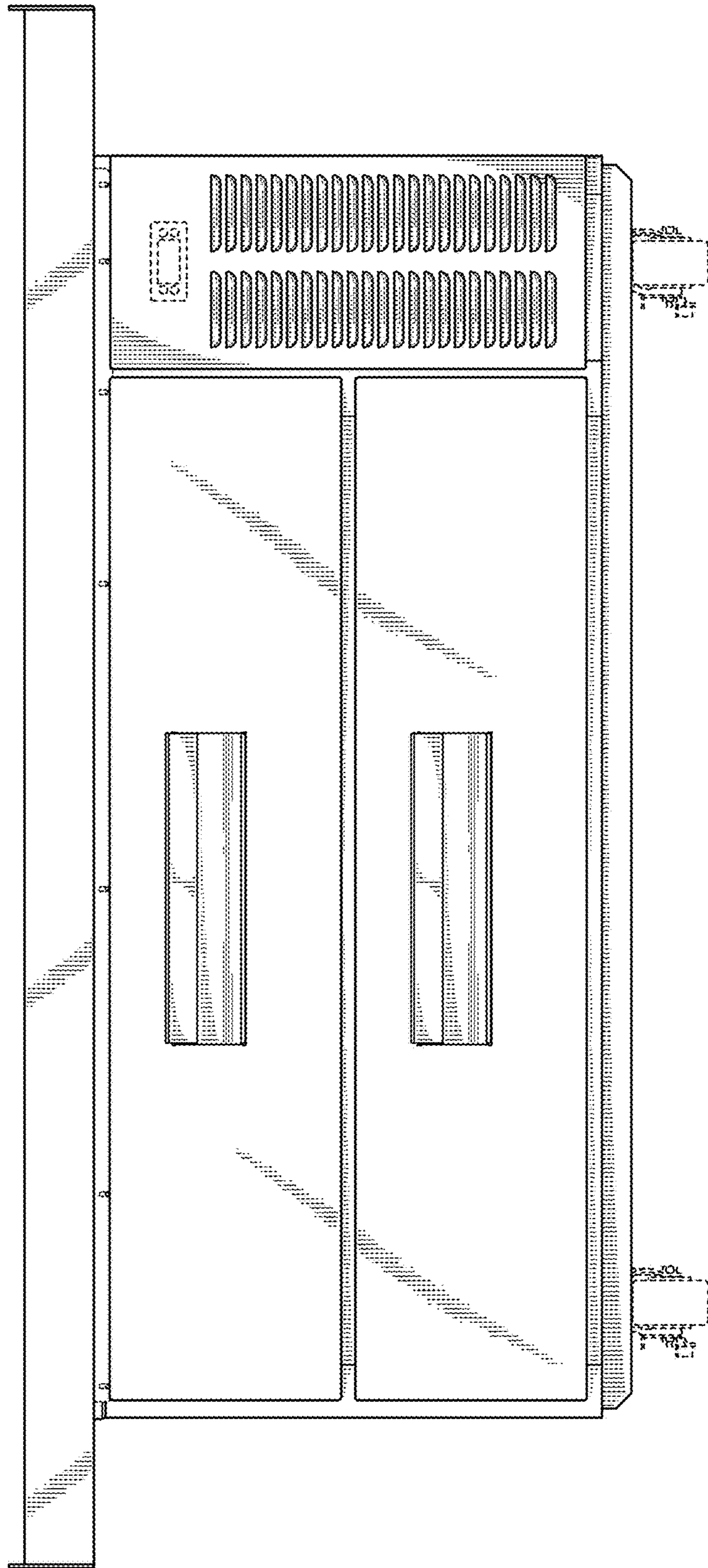

FIG. 2

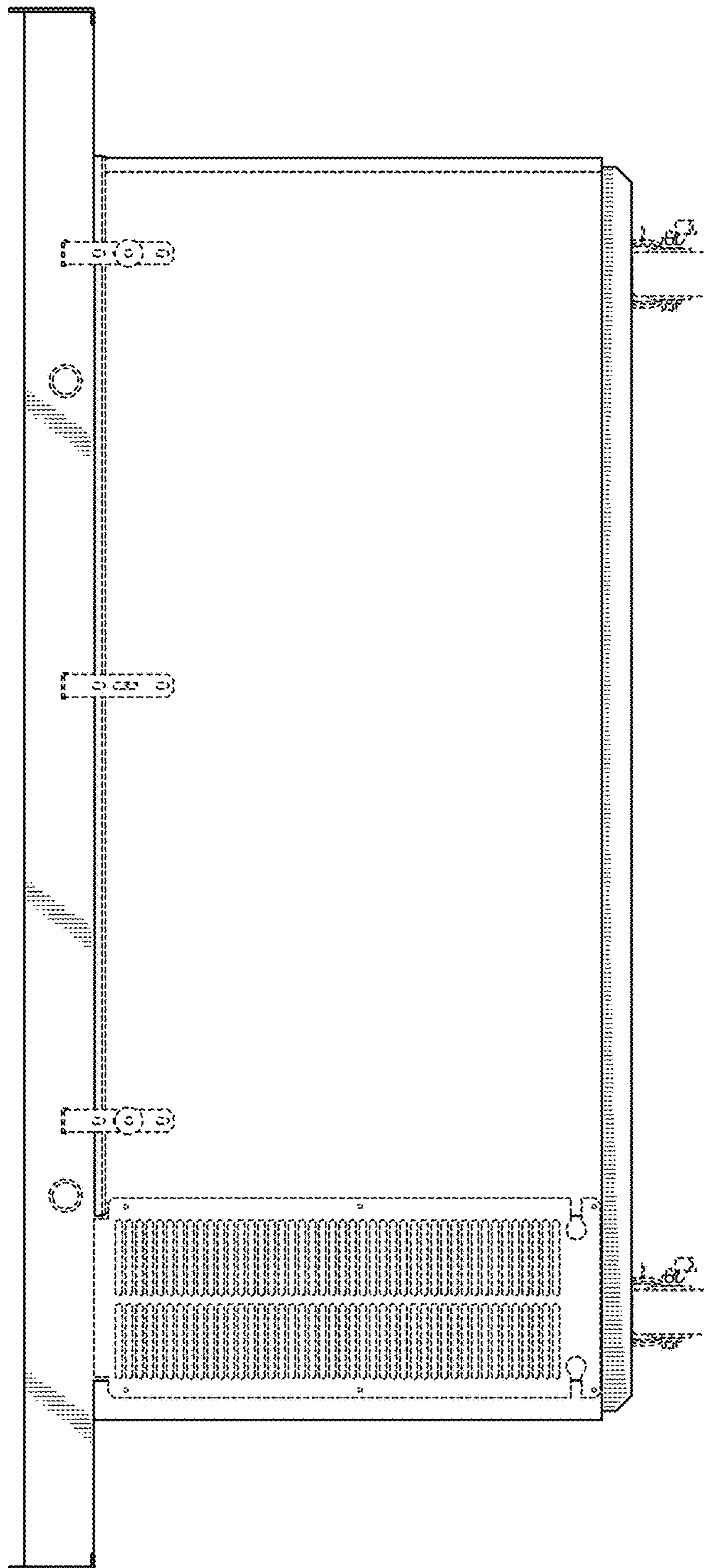

FIG. 3

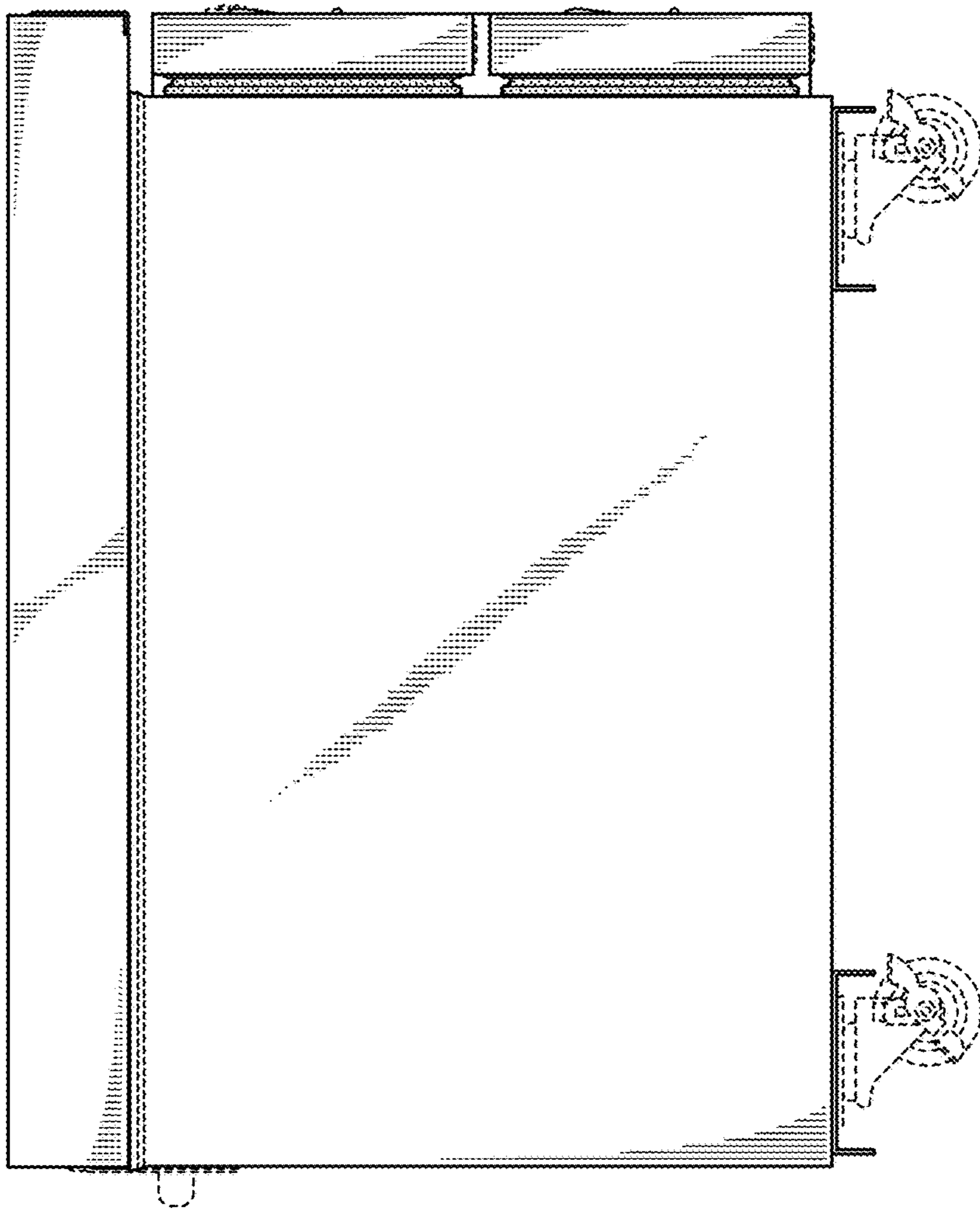

FIG. 4

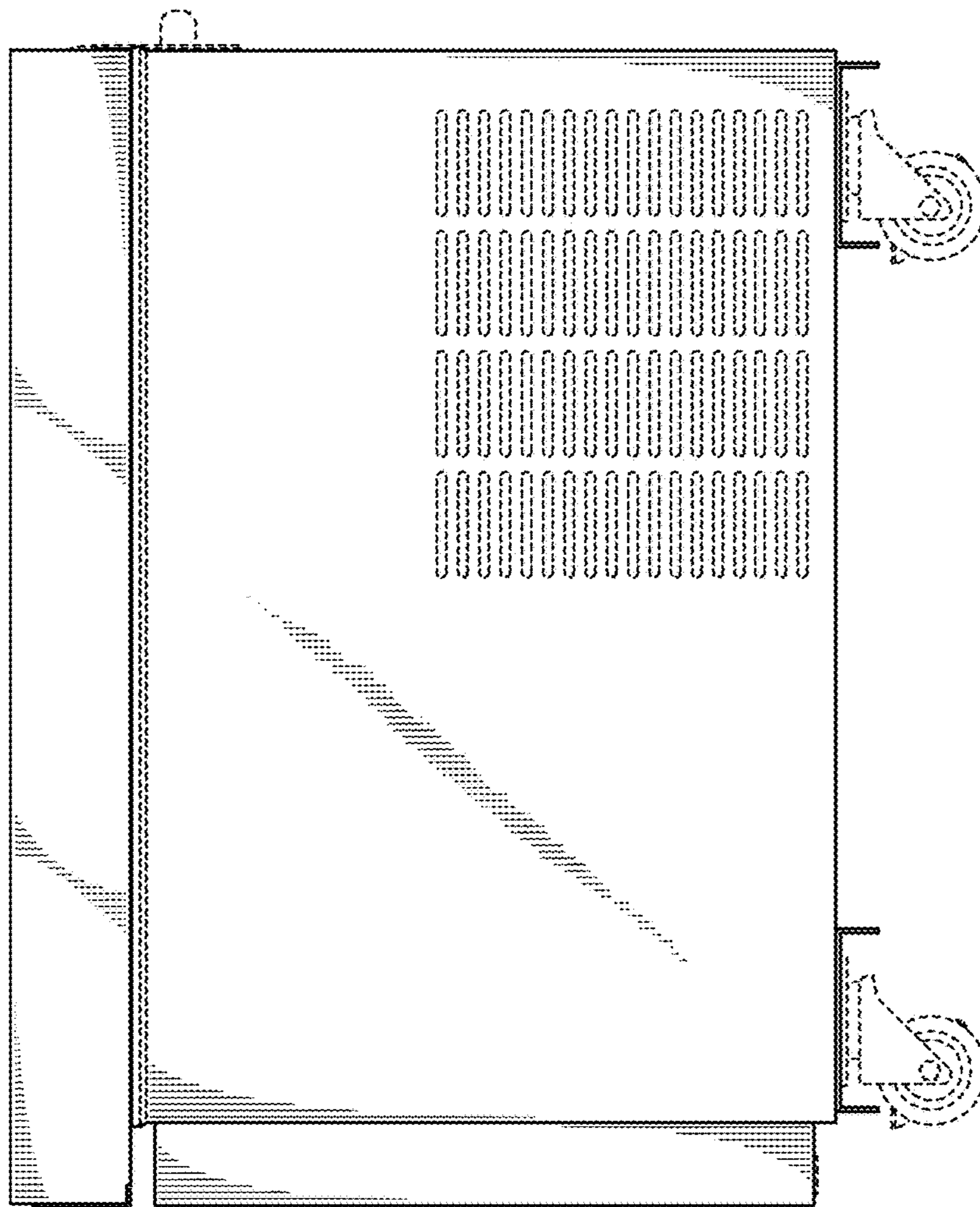

FIG. 5

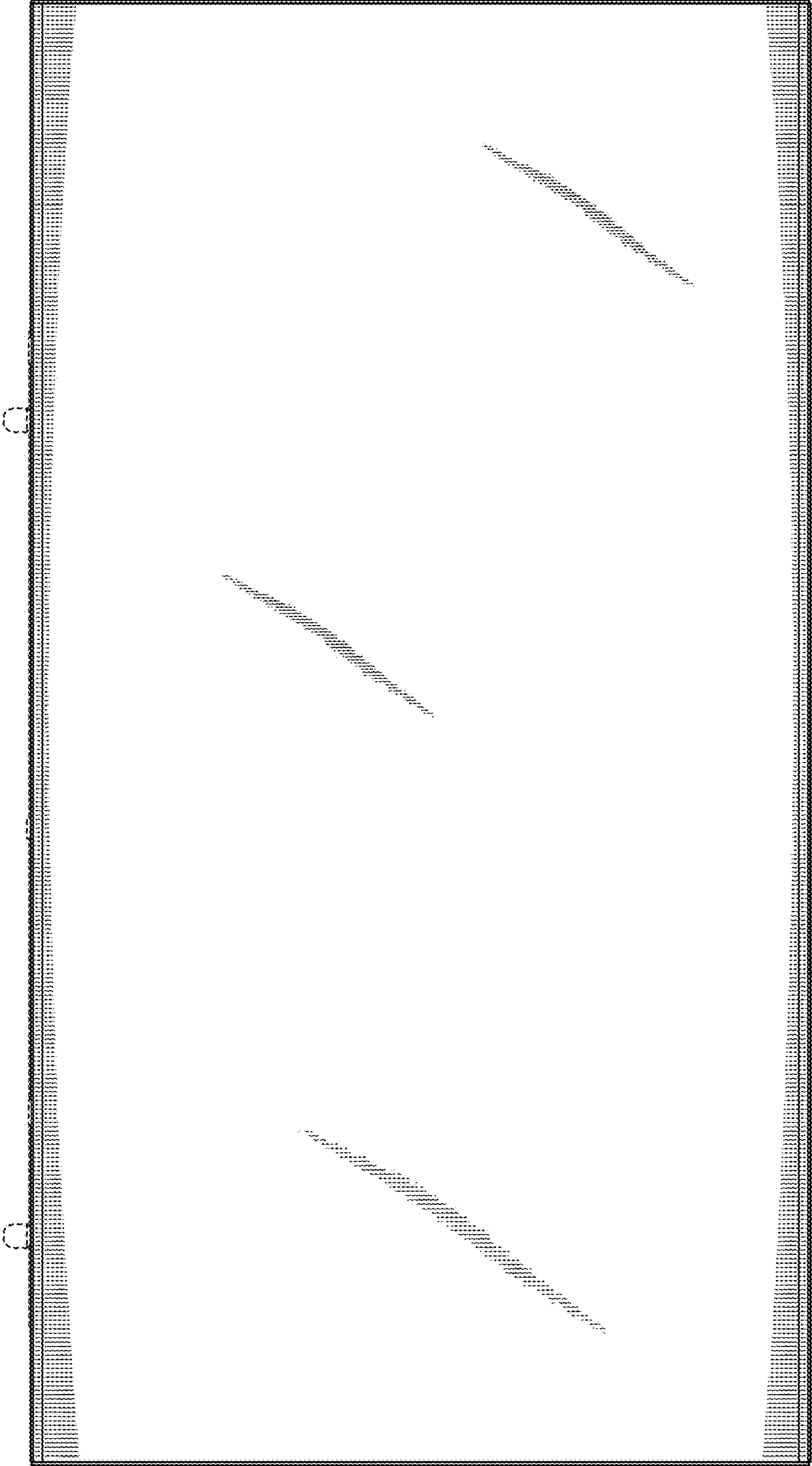

FIG. 6

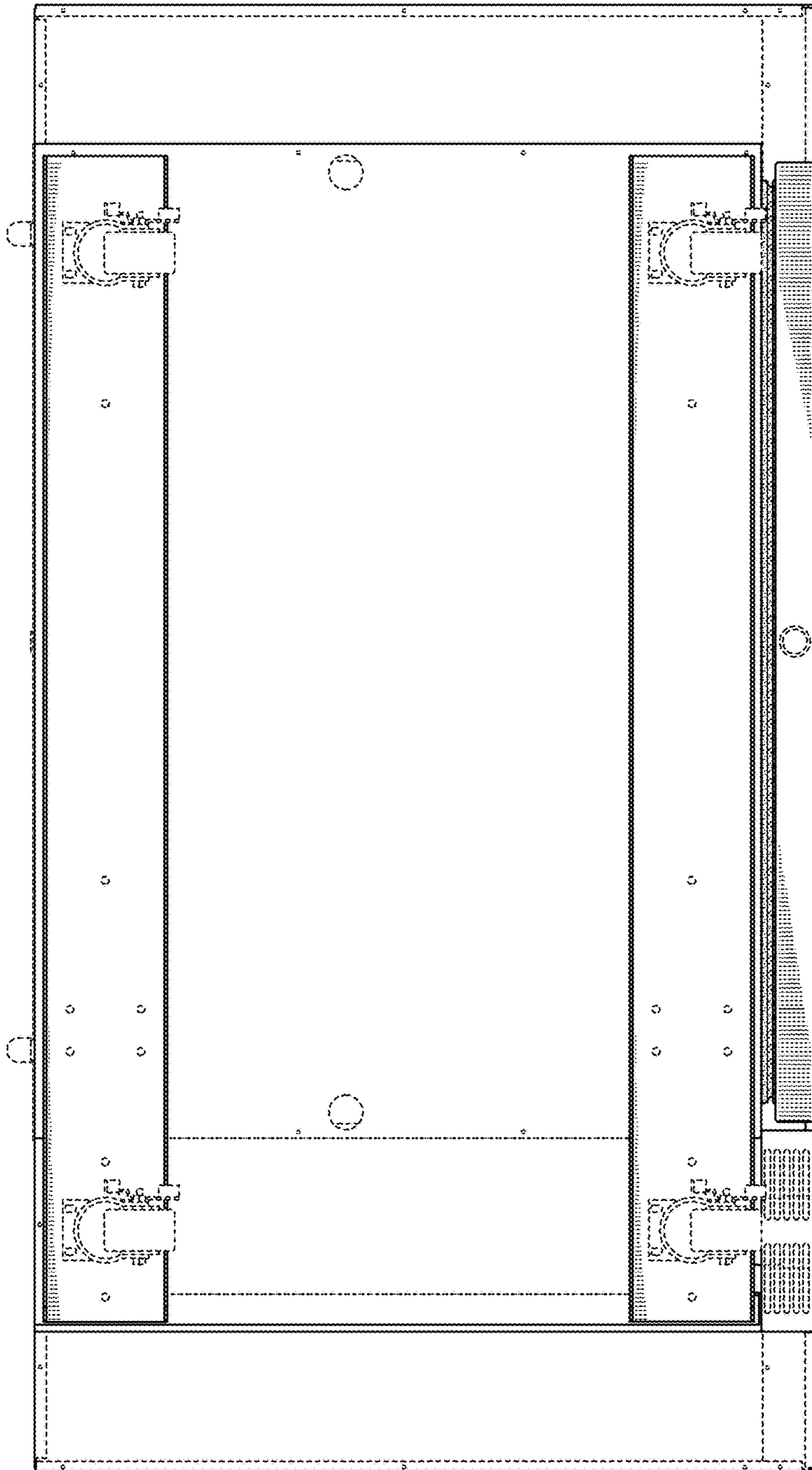

FIG. 7