



US00D818981S

(12) **United States Design Patent**  
**Song**

(10) **Patent No.:** **US D818,981 S**

(45) **Date of Patent:** **\*\* May 29, 2018**

(54) **ELECTRONIC DEVICE**

(71) Applicant: **SAMSUNG ELECTRONICS CO., LTD.**, Suwon-si, Gyeonggi-do (KR)

(72) Inventor: **Junyong Song**, Seongnam-si (KR)

(73) Assignee: **SAMSUNG ELECTRONICS CO., LTD.**, Gyeonggi-Do (KR)

(\*\*) Term: **15 Years**

(21) Appl. No.: **29/562,735**

(22) Filed: **Apr. 28, 2016**

(30) **Foreign Application Priority Data**

Nov. 20, 2015 (KR) ..... 30-2015-0058488

(51) **LOC (11) Cl.** ..... **14-03**

(52) **U.S. Cl.**  
USPC ..... **D14/138 AB**

(58) **Field of Classification Search**  
USPC ..... D14/138 AB, 345, 138 R, 496, 203.4,  
D14/138 G, 138 C; 455/575.3; D21/517  
CPC ..... G06F 1/1616; H04M 1/0216; H04M  
1/0214; H04M 1/03  
See application file for complete search history.

(56) **References Cited**

**U.S. PATENT DOCUMENTS**

- D321,865 S \* 11/1991 Derocher ..... D14/345
- D563,924 S \* 3/2008 Arnold ..... D14/138 AB
- D573,127 S \* 7/2008 Choi ..... D14/138 AB
- D578,501 S \* 10/2008 Seo ..... D14/138 AB
- D578,988 S \* 10/2008 Chung ..... D14/138 AB
- D583,791 S \* 12/2008 Minamide ..... D14/138 AB
- D583,793 S \* 12/2008 Tkachuk ..... D14/138 AB
- D584,276 S \* 1/2009 Kim ..... D14/138 AB
- D588,571 S \* 3/2009 Yasuda ..... D14/138 AB
- D591,260 S \* 4/2009 Kim ..... D14/138 AB
- D591,712 S \* 5/2009 Kim ..... D14/138 AB

- D593,521 S \* 6/2009 Tan ..... D14/138 AB
- D597,990 S \* 8/2009 Lee ..... D14/138 AB
- D603,354 S \* 11/2009 Kim ..... D14/138 AB
- D604,262 S \* 11/2009 Lee ..... D14/138 AB
- D626,931 S \* 11/2010 Kim ..... D14/138 AB
- D627,324 S \* 11/2010 Kim ..... D14/138 AB
- D630,180 S \* 1/2011 Kim ..... D14/138 AB
- D631,451 S \* 1/2011 Kim ..... D14/138 AB
- D635,116 S \* 3/2011 Lee ..... D14/138 AB

(Continued)

**OTHER PUBLICATIONS**

Samsung W2016, posted on phonearena.com on Nov. 4, 2015, [online], [site visited Aug. 21, 2017]. Available from Internet, <URL:https://www.phonearena.com/phones/Samsung-W2016\_id10303>.\*

(Continued)

*Primary Examiner* — Jeffrey D Asch

(74) *Attorney, Agent, or Firm* — Cantor Colburn LLP

(57) **CLAIM**

The ornamental design for a electronic device, as shown and described.

**DESCRIPTION**

FIG. 1 is a front perspective view of an electronic device showing my new design;  
FIG. 2 is a front view thereof;  
FIG. 3 is a rear view thereof;  
FIG. 4 is a left-side view thereof;  
FIG. 5 is a right-side view thereof;  
FIG. 6 is a top view thereof;  
FIG. 7 is a bottom view thereof;  
FIG. 8 is a rear perspective view thereof; and,  
FIG. 9 is another front perspective view thereof as shown in another configuration.  
The broken lines shown in drawings illustrates portions of the electronic device that form no part of the claimed design.

**1 Claim, 7 Drawing Sheets**

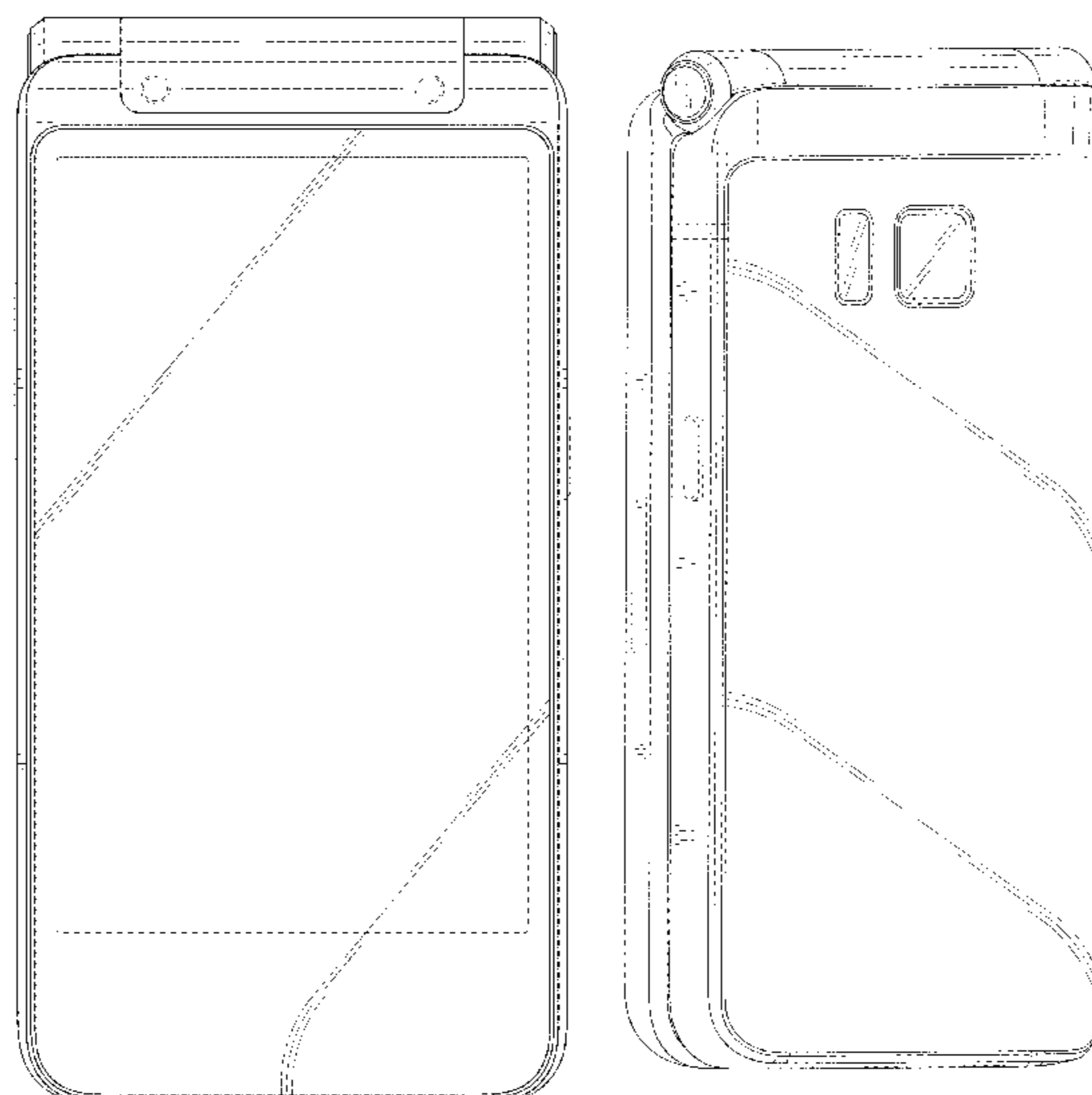

(56)

**References Cited**

U.S. PATENT DOCUMENTS

D640,217	S *	6/2011	Suk	.....	D14/138	AA
D643,010	S *	8/2011	Park	.....	D14/138	AB
D643,011	S *	8/2011	Park	.....	D14/138	AB
D647,867	S *	11/2011	Chung	.....	D14/138	AB
D648,697	S *	11/2011	Castano	.....	D14/138	AB
D649,954	S *	12/2011	Baik	.....	D14/138	AB
8,180,418	B2 *	5/2012	Nakazawa	.....	H04M 1/0216	
					455/550.1	
D770,408	S *	11/2016	Lee	.....	D14/138	G
9,727,299	B2 *	8/2017	Song	.....	G06F 3/1446	
D801,944	S *	11/2017	Kim	.....	D14/138	AB
9,831,928	B2 *	11/2017	Kim	.....	H04B 7/0404	
2008/0125197	A1 *	5/2008	Hongo	.....	H04M 1/0216	
					455/575.3	
2017/0141820	A1 *	5/2017	Kim	.....	H04B 1/40	

OTHER PUBLICATIONS

LG Wine 4, posted on phonearena.com on May 27, 2016, [online], [site visited Aug. 21, 2017]. Available from Internet, <URL:https://www.phonearena.com/phones/LG-Wine-4\_id10072>.\*

Samsung I9230 Galaxy Golden, Released Nov. 2013, [online], [site visited Jun. 5, 2017]. Available from Internet, <URL: http://http://www.gsmarena.com/samsung\_i9230\_galaxy\_golden-5814.php>.\*

Samsung Galaxy Folder, Released Jul. 2015 [online], [site visited Jun. 5, 2017]. Available from Internet, <URL: http://www.gsmarena.com/samsung\_galaxy\_folder-pictures-7453.php>.\*

Sharp 936SH, Released Sep. 2009 [online], [site visited Jun. 5, 2017]. Available from Internet, <URL: http://www.gsmarena.com/sharp\_936sh-3053.php>.\*

Pantech S902, Released Nov. 2010 [online], [site visited Jun. 5, 2017]. Available from Internet, <URL: http://www.gsmarena.com/pantech\_s902-3637.php>.\*

Samsung W999, Released 1st Quarter 2012 [online], [site visited Jun. 5, 2017]. Available from Internet, <URL: http://www.gsmarena.com/samsung\_w999-4660.php>.\*

Samsung E215, Released 1st Quarter 2009 [online], [site visited Jun. 5, 2017]. Available from Internet, <URL: http://http://www.gsmarena.com/samsung\_e215-2502.php>.\*

\* cited by examiner

FIG. 1

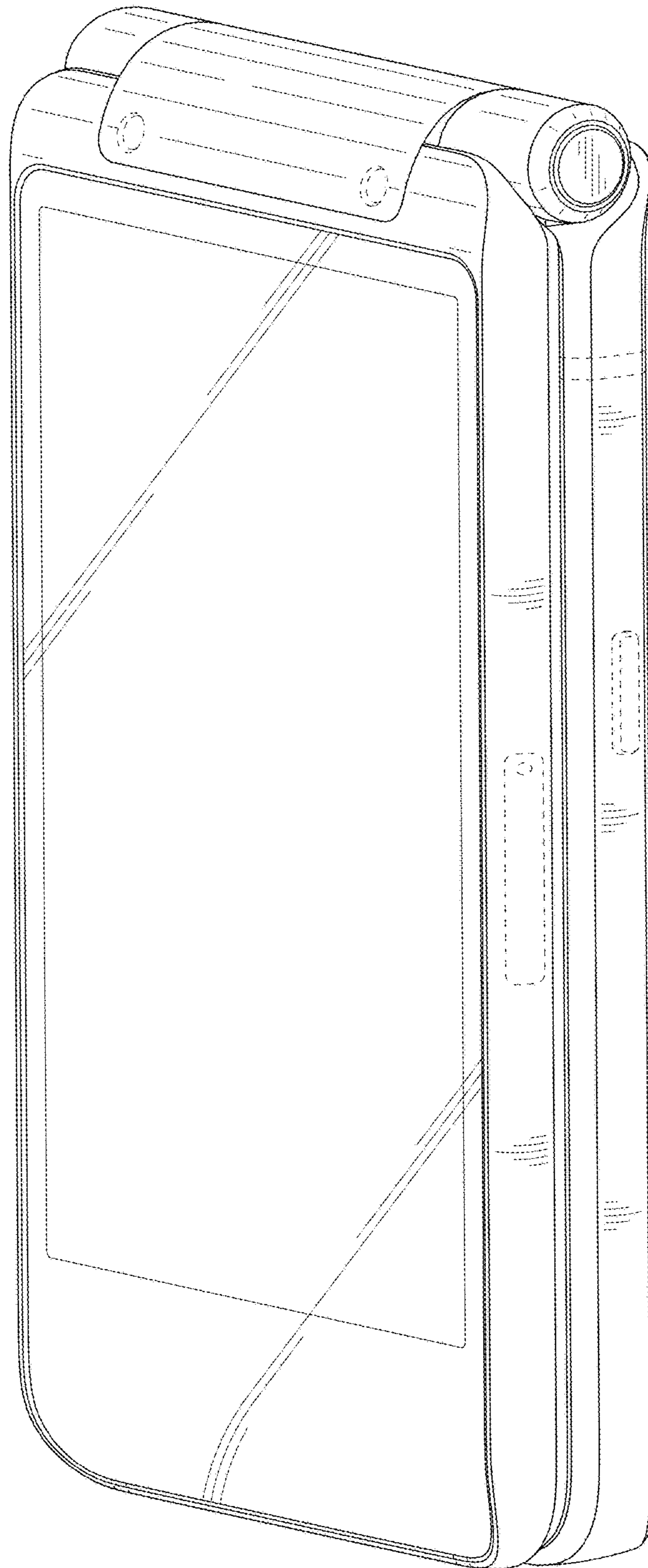

FIG.2

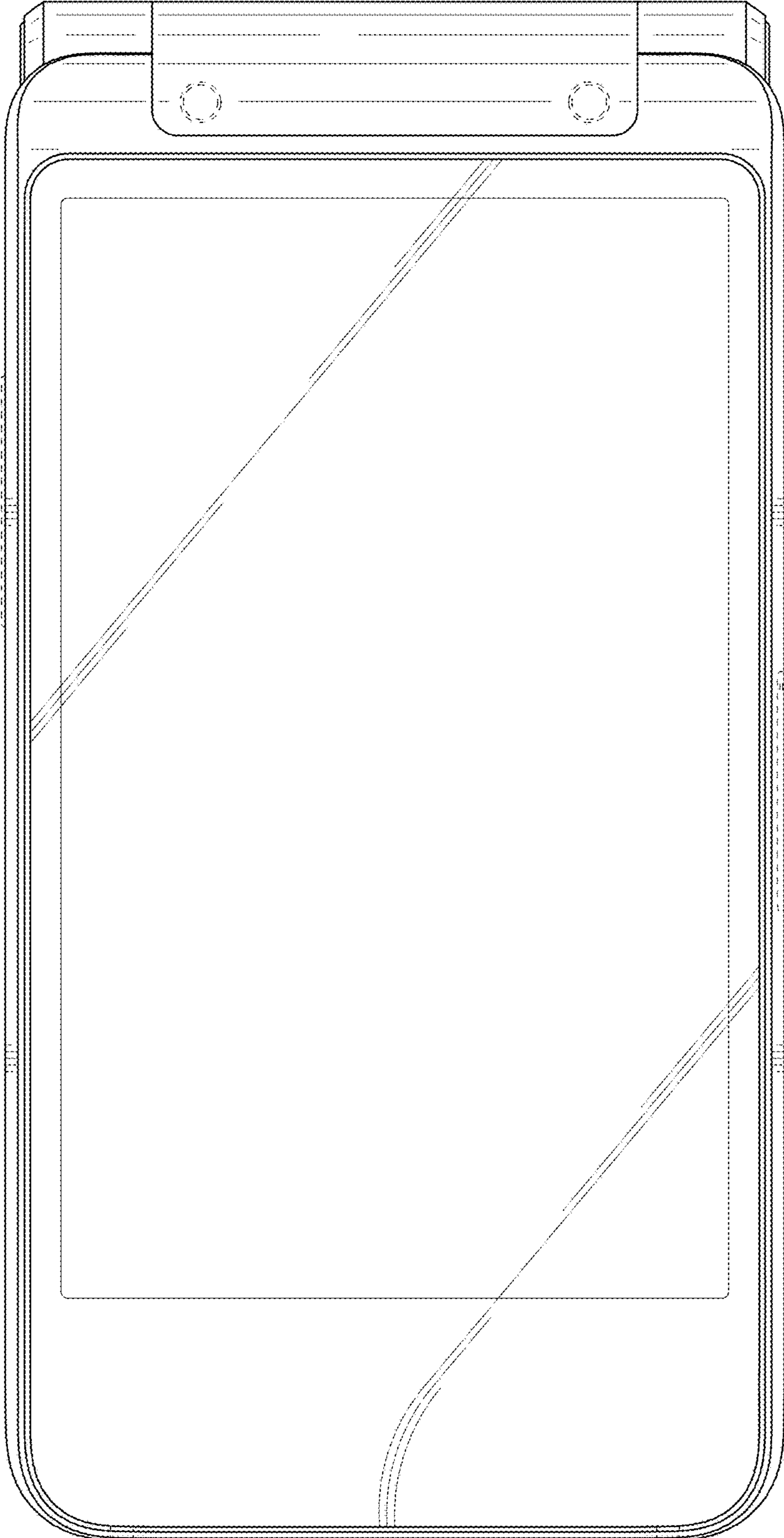



FIG.3

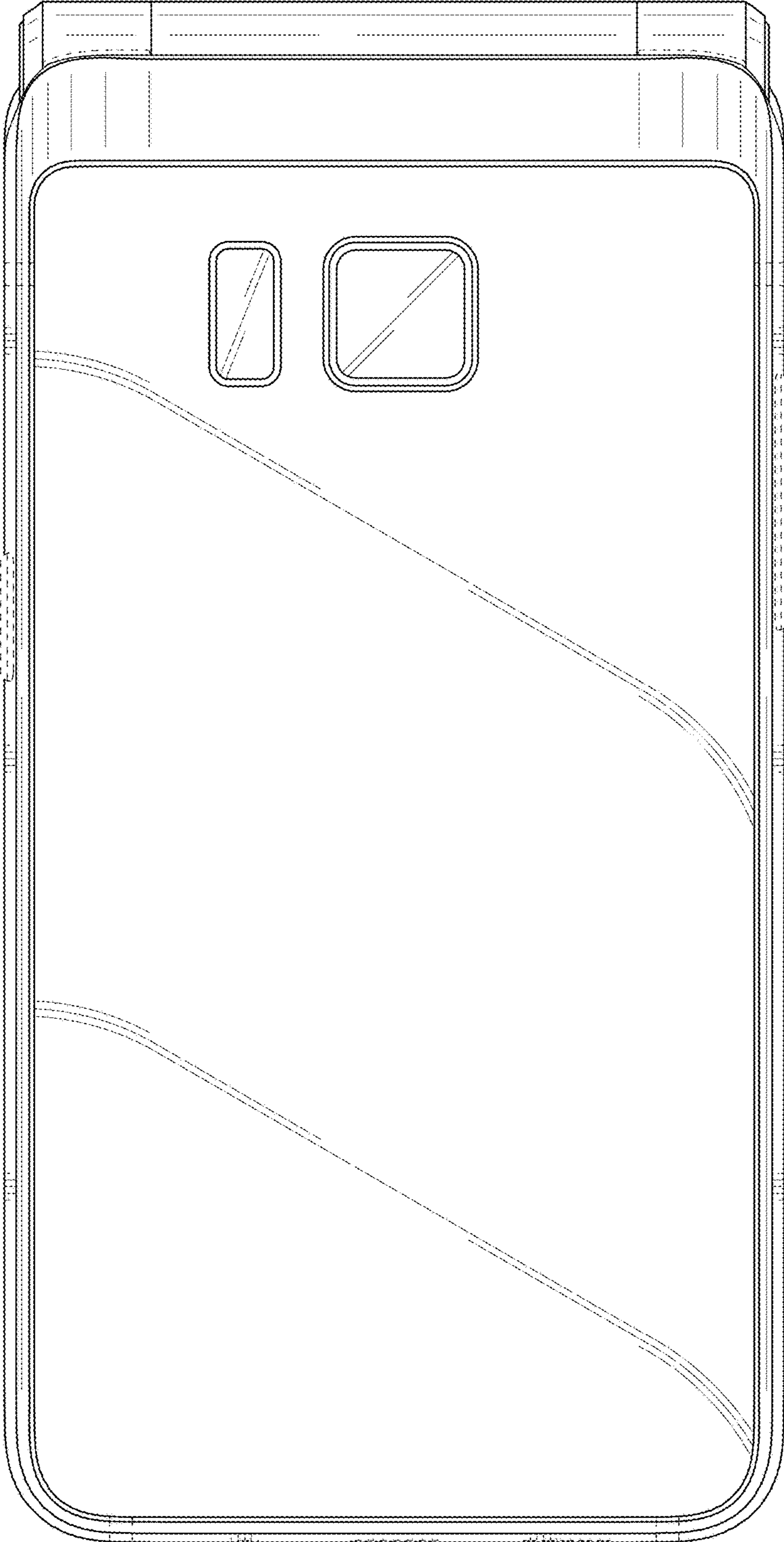

FIG.4

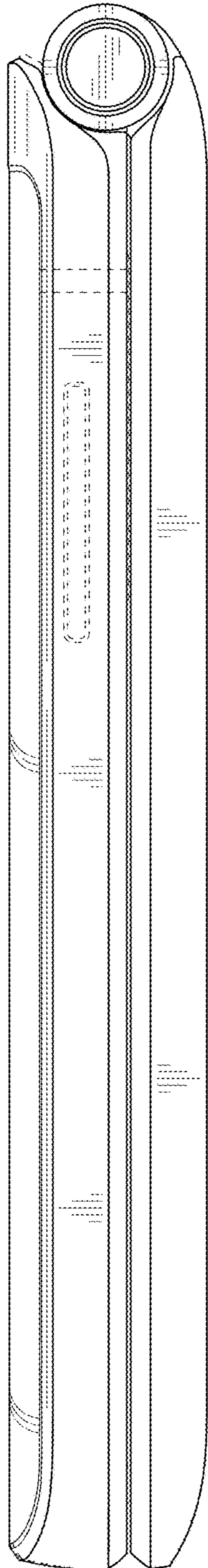

FIG.5

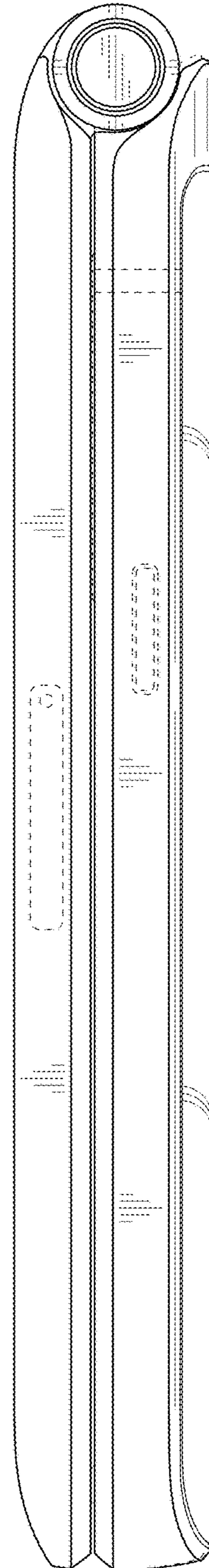

FIG.6

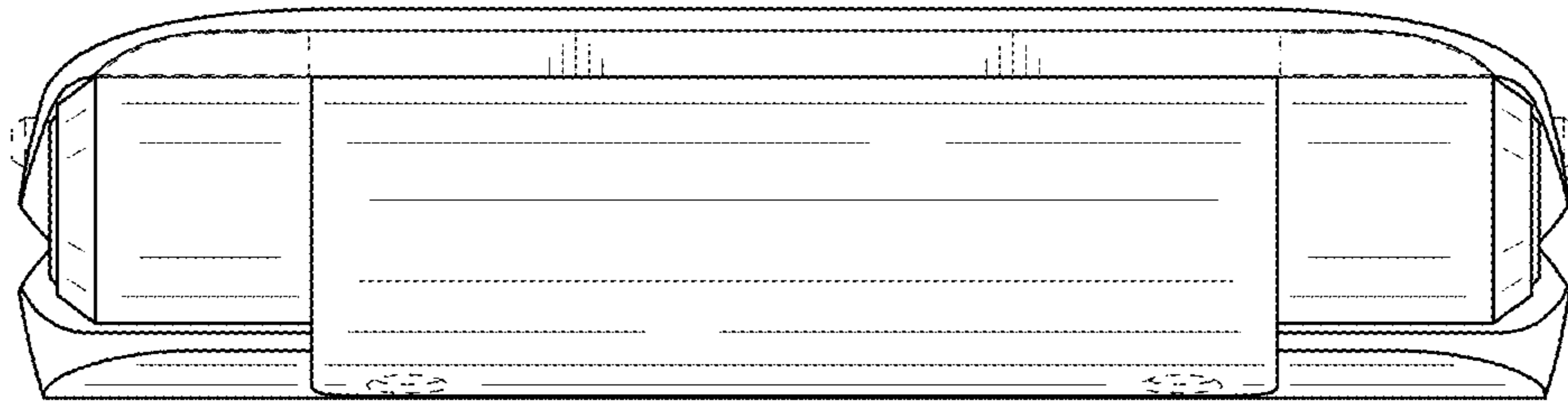

FIG.7

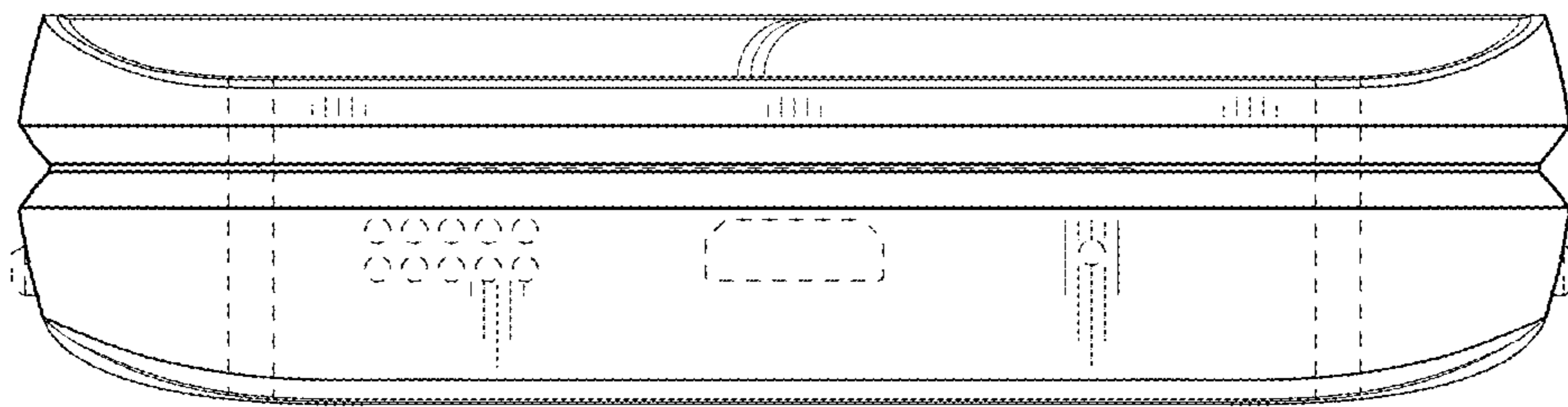

FIG.8

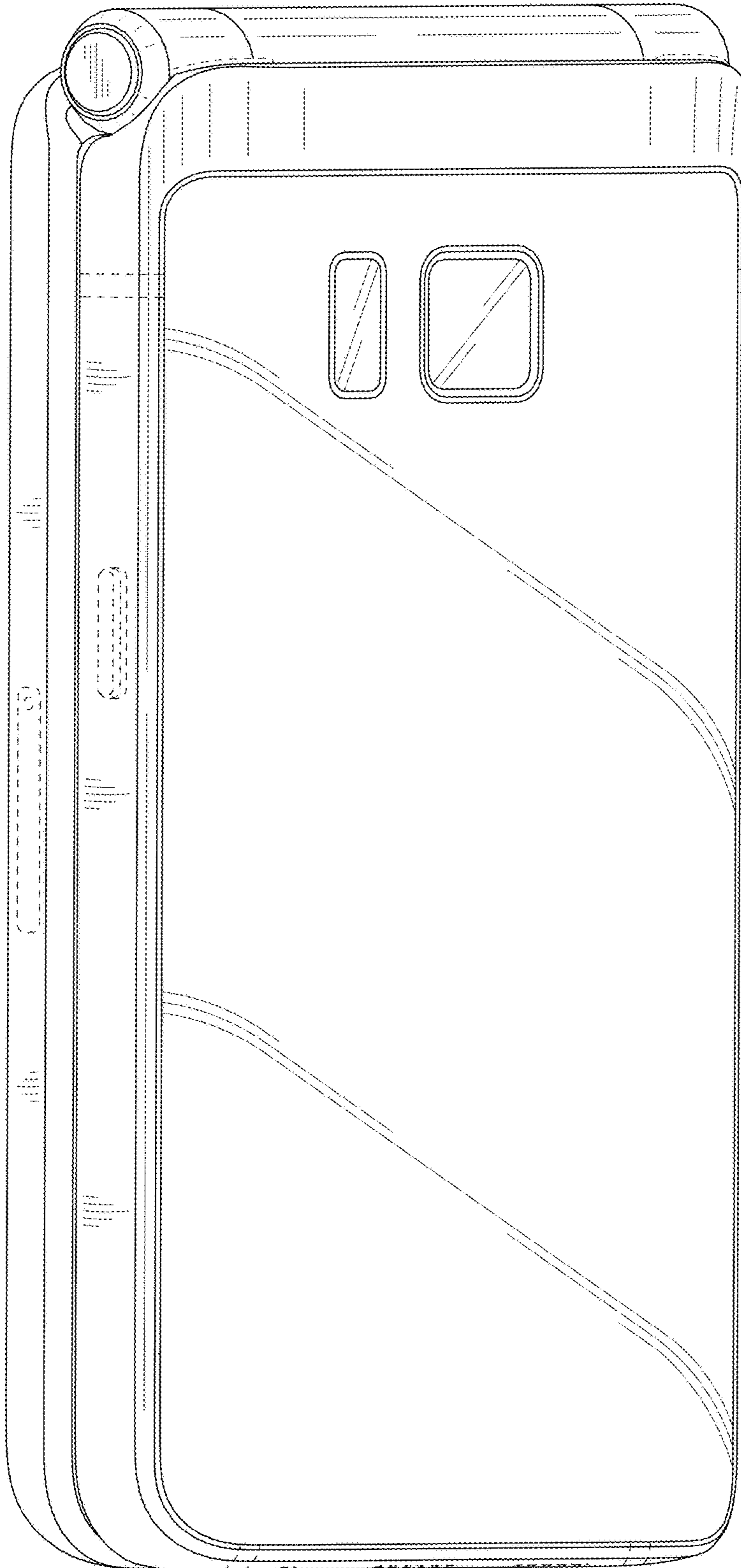



FIG.9

