



US00D818894S

(12) **United States Design Patent** (10) **Patent No.:** **US D818,894 S**
Waterhouse et al. (45) **Date of Patent:** **** May 29, 2018**

(54) **AIR INTAKE GRILLE FOR VEHICLE**
(71) Applicant: **Volvo Lastvagnar AB**, Göteborg (SE)
(72) Inventors: **Miles Waterhouse**, Greensboro, NC (US); **Jeff Cotner**, Greensboro, NC (US)
(73) Assignee: **VOLVO LASTVAGNAR AB**, Gothenburg (SE)
(**) Term: **15 Years**
(21) Appl. No.: **29/600,037**
(22) Filed: **Apr. 10, 2017**
(51) **LOC (11) Cl.** **12-16**
(52) **U.S. Cl.**
USPC **D12/163**
(58) **Field of Classification Search**
USPC D12/163, 169, 196, 86, 90-92, 88
CPC B62D 25/08; B60K 11/08; B60R 19/05
See application file for complete search history.

(56) **References Cited**
U.S. PATENT DOCUMENTS
D425,834 S * 5/2000 Sousamian D12/163
D427,119 S * 6/2000 Sousamian D12/163
D455,984 S * 4/2002 Boulay D12/92
D486,101 S * 2/2004 Sun D12/163
D499,992 S * 12/2004 Chan D12/173
D566,015 S * 4/2008 Beigel D12/163
D567,724 S * 4/2008 Irie D12/169
D571,258 S * 6/2008 Baum D12/92
D597,448 S * 8/2009 Jacob D12/88
D610,040 S * 2/2010 Thompson D12/91
D614,544 S * 4/2010 Ectors D12/163
D626,897 S * 11/2010 Ectors D12/163
D633,832 S * 3/2011 Matei D12/163
D692,350 S * 10/2013 Toriyama D12/92
D710,256 S * 8/2014 Garand D12/91
D718,188 S * 11/2014 Wheel D12/91

D722,920 S * 2/2015 Minami D12/92
D730,775 S * 6/2015 Frenzel D12/91
D737,175 S * 8/2015 Telaak D12/92
D744,903 S * 12/2015 Jelec D12/92
D753,023 S * 4/2016 Villevoye D12/88
D762,526 S * 8/2016 Minami D12/92
D766,134 S * 9/2016 An D12/92
D767,446 S * 9/2016 Stephenson D12/88
D780,063 S * 2/2017 Stephenson D12/88
D784,204 S * 4/2017 Abdallah D12/92
D786,150 S * 5/2017 Carter B60K 11/06
D12/169
D790,412 S * 6/2017 Dunford B60K 11/06
D12/163
9,802,474 B2 * 10/2017 Kawabata B60K 11/06
D801,857 S * 11/2017 Kim D12/88
D801,887 S * 11/2017 Peat D12/169
9,821,742 B2 * 11/2017 Abe B60R 19/52
(Continued)

OTHER PUBLICATIONS

Images of Volvo VNL Truck, released 2002, 2 pages.
Primary Examiner — Robin V Webster
Assistant Examiner — Rachel Voorhies
(74) *Attorney, Agent, or Firm* — Tucker Ellis LLP

(57) **CLAIM**
The ornamental design for an air intake grille for vehicle, as shown and described.

DESCRIPTION

FIG. 1 is a perspective view of an air intake grille for vehicle showing our new design.
FIG. 2 is a front view thereof.
FIG. 3 is a rear view thereof.
FIG. 4 is a right side view thereof.
FIG. 5 is a left side view thereof.
FIG. 6 is a top view thereof; and,
FIG. 7 is a bottom view thereof.

1 Claim, 4 Drawing Sheets

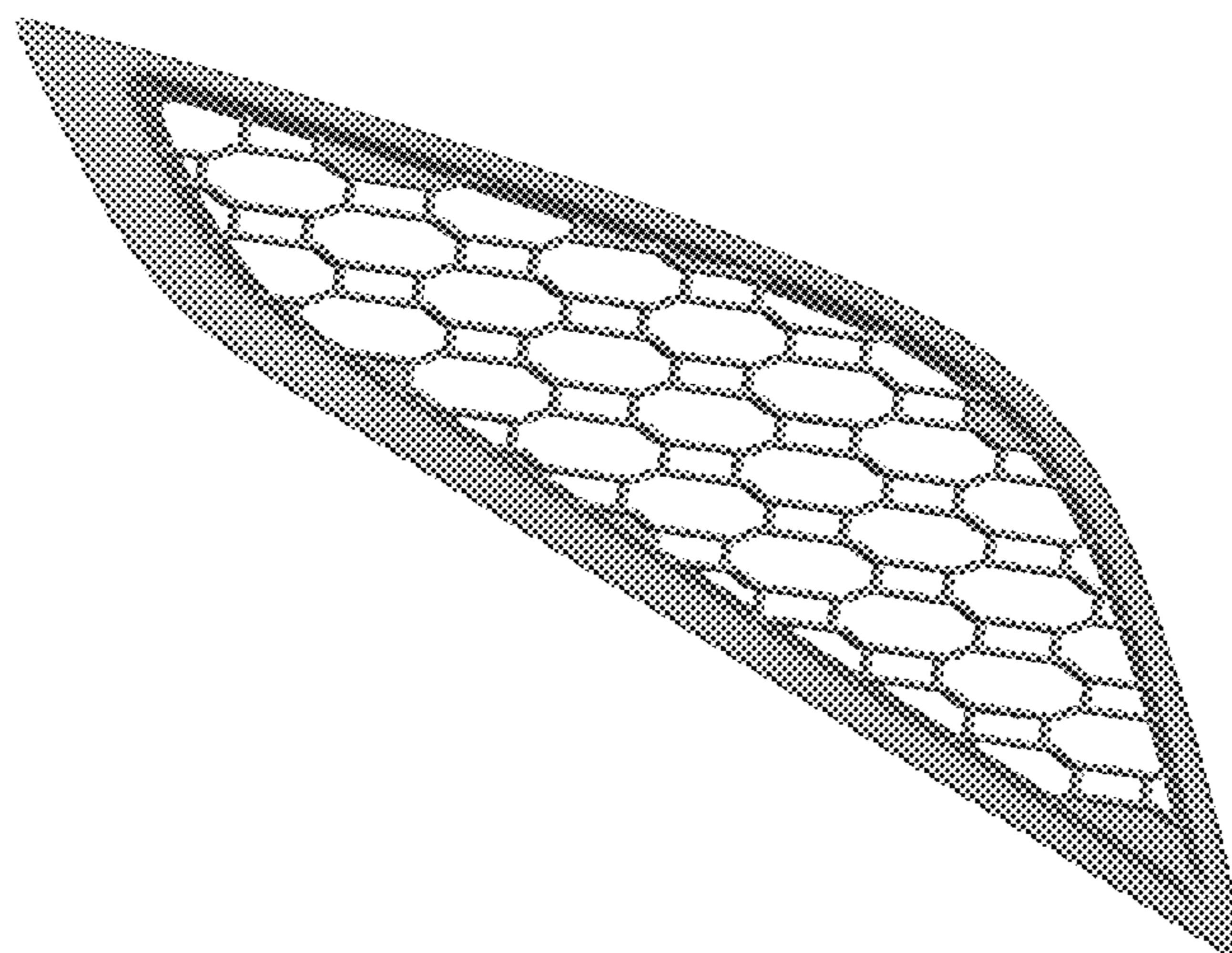

(56)

References Cited

U.S. PATENT DOCUMENTS

D804,355 S * 12/2017 Stephenson D12/88
D805,436 S * 12/2017 Yamashita D12/92
2009/0072556 A1* 3/2009 Kudelko B60R 19/52
293/115
2010/0127535 A1* 5/2010 Barcelo B62D 25/081
296/208
2017/0113537 A1* 4/2017 Kawabata B60K 11/06

* cited by examiner

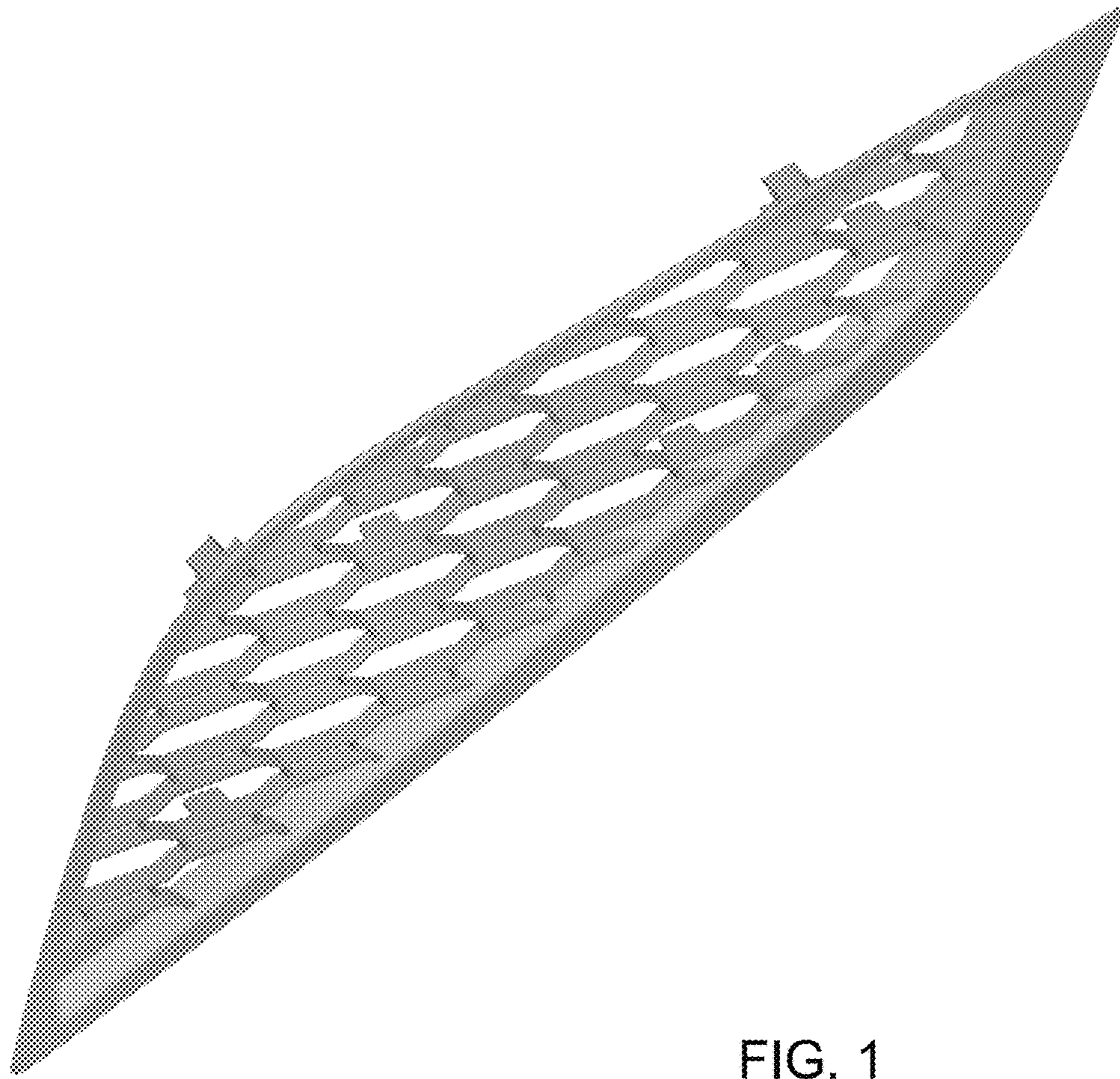

FIG. 1

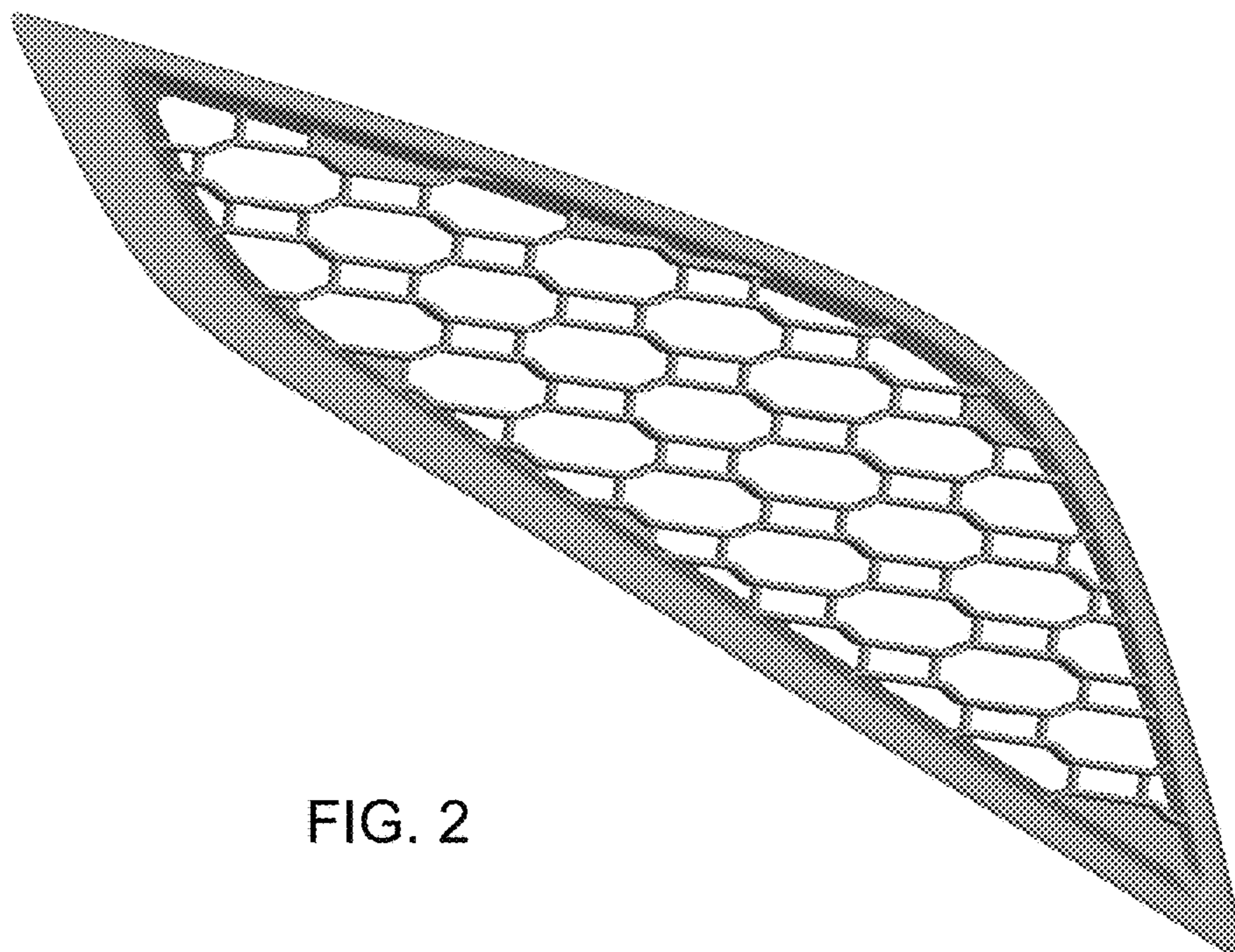

FIG. 2

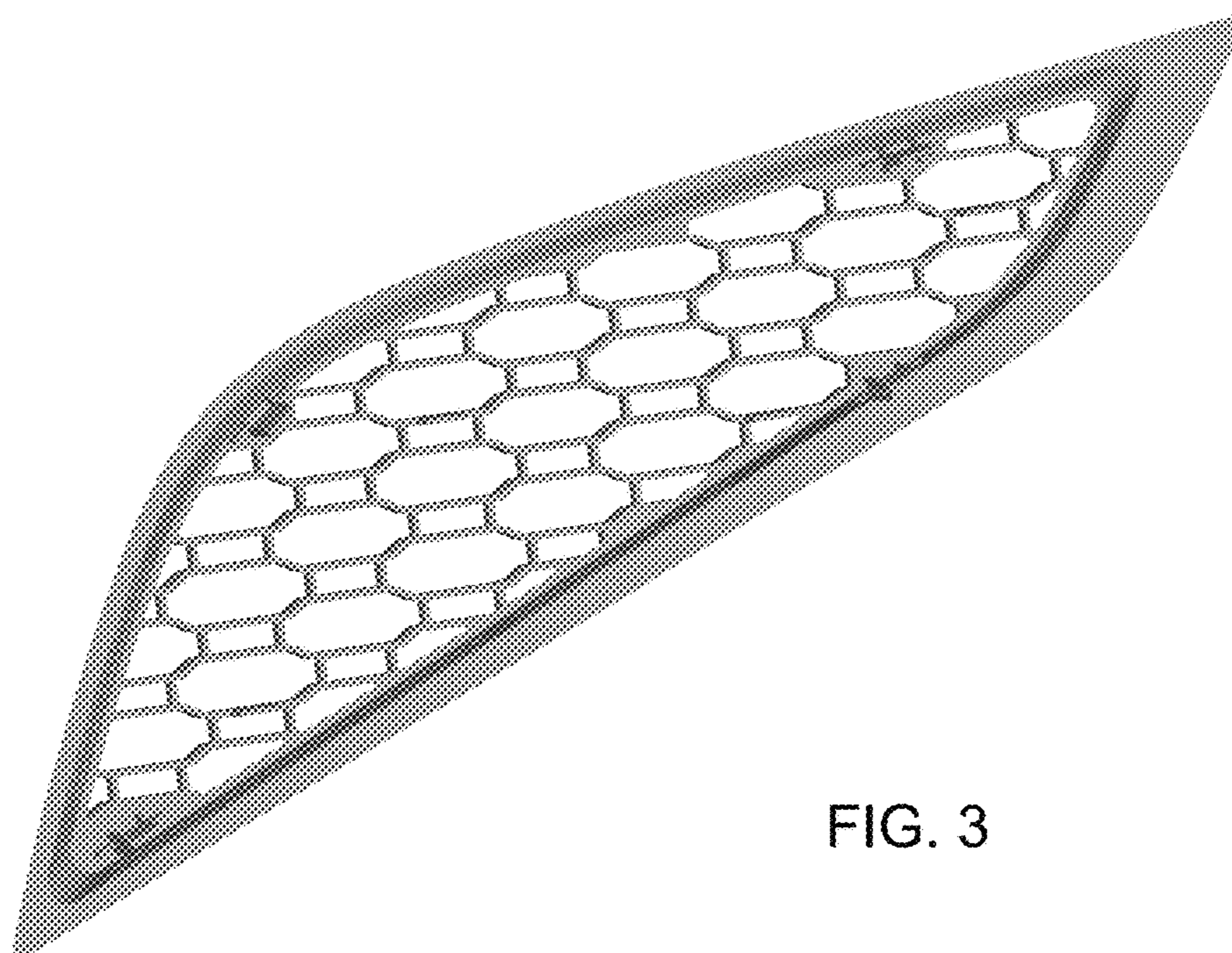

FIG. 3

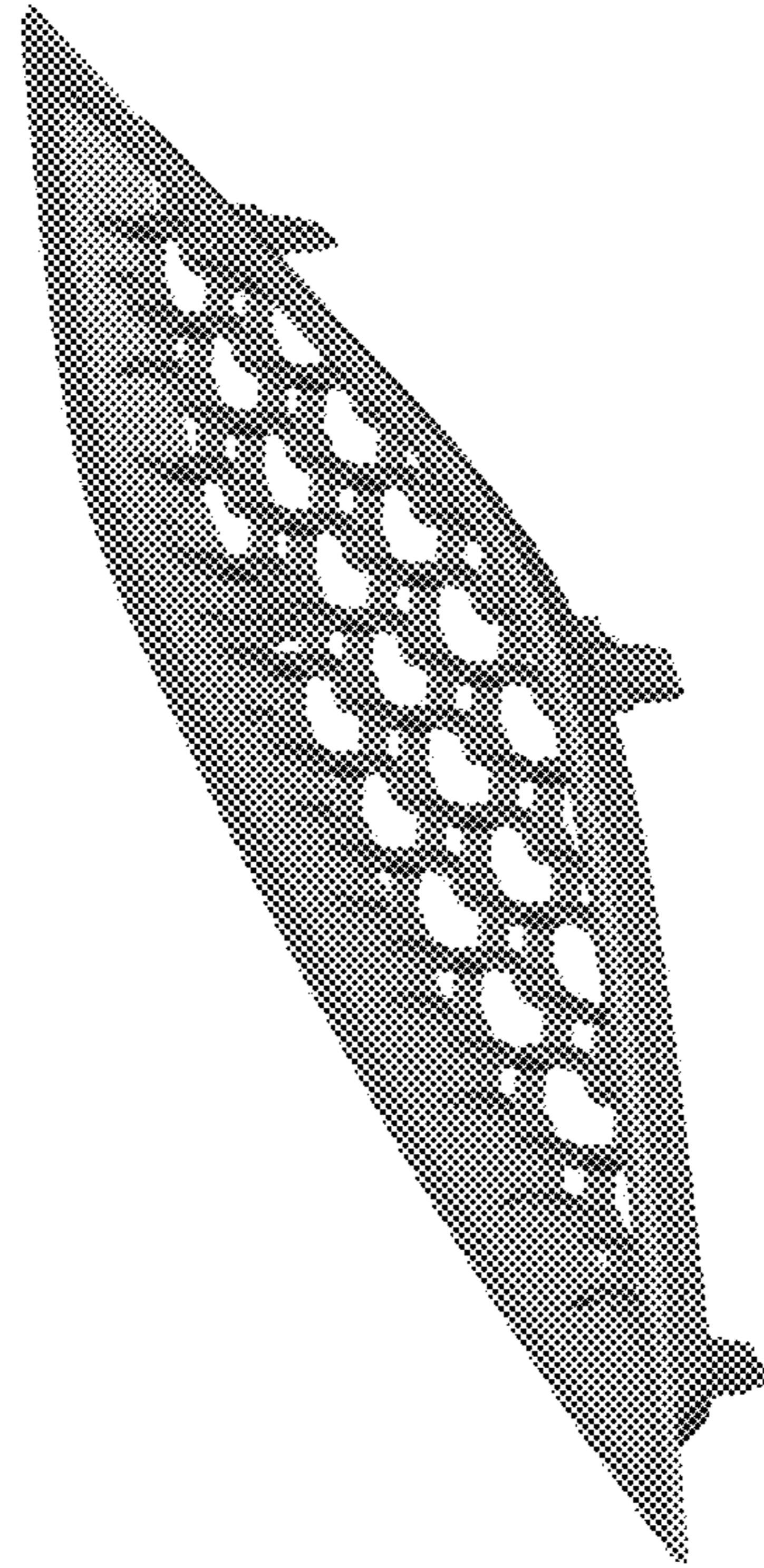

FIG. 4

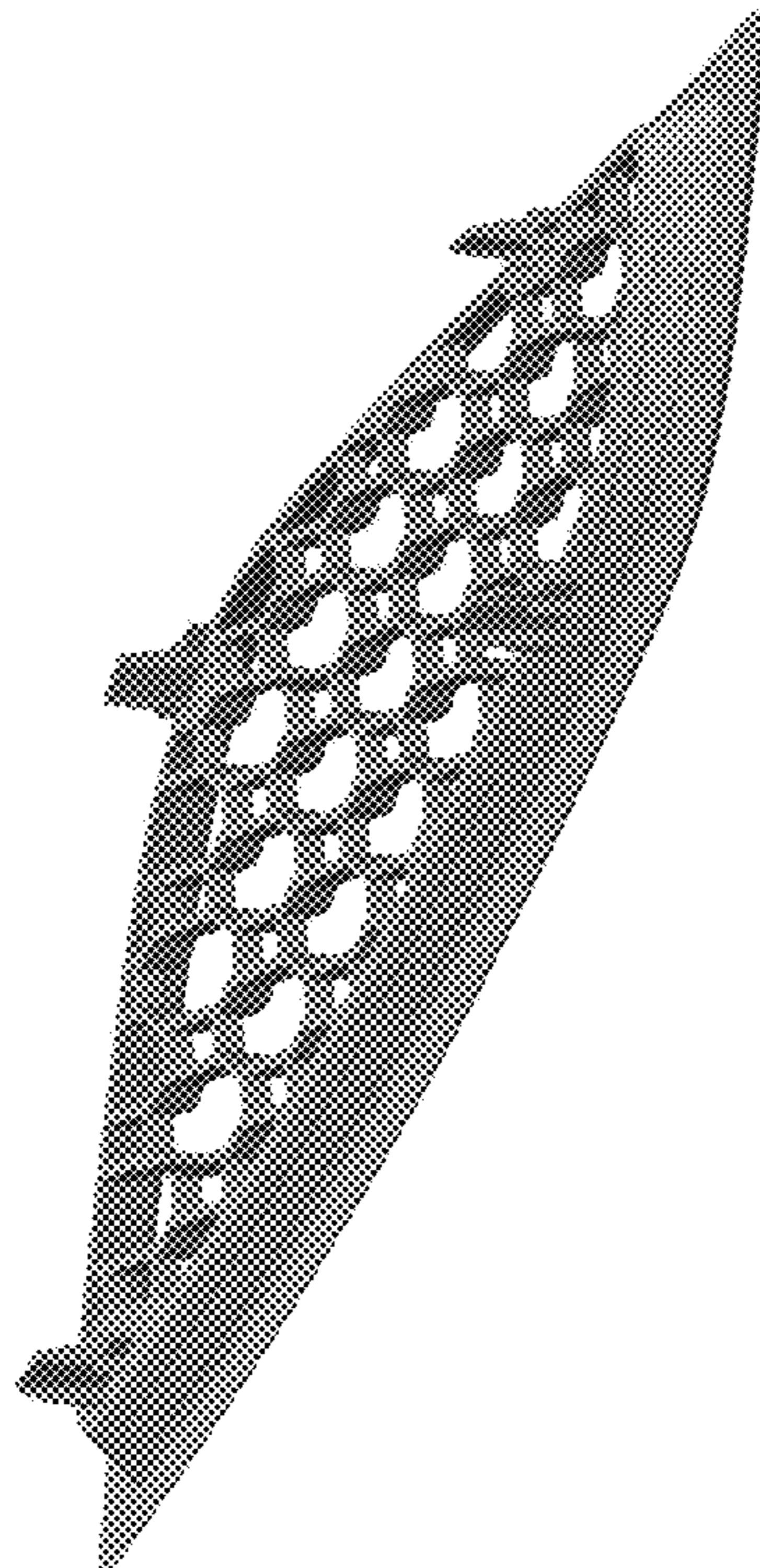

FIG. 5

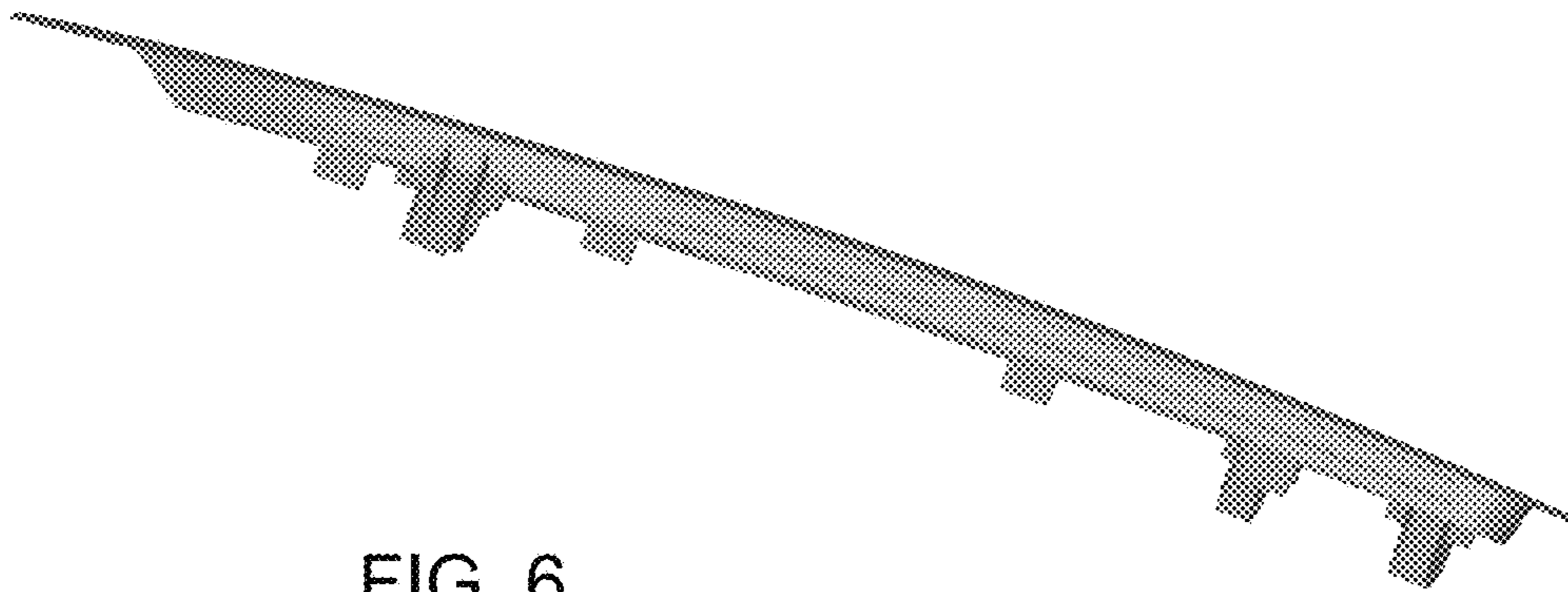

FIG. 6

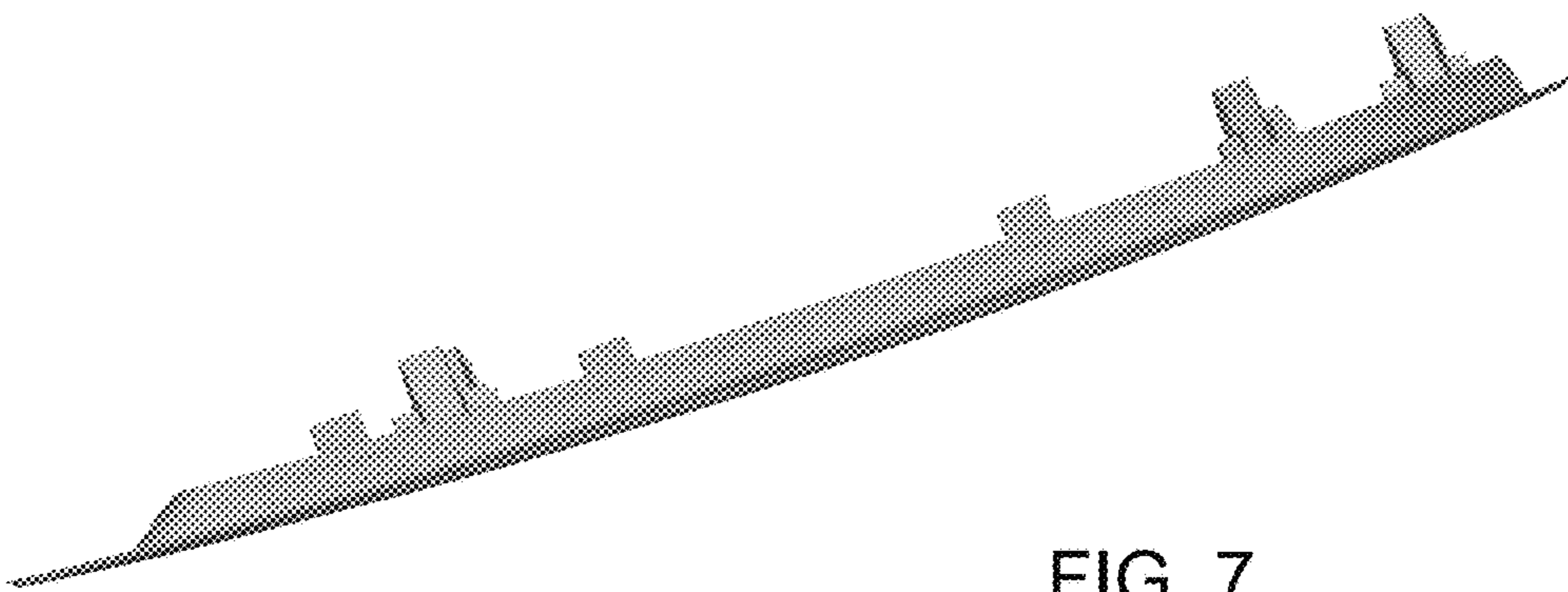

FIG. 7