



US00D818841S

(12) **United States Design Patent**
Newton

(10) **Patent No.:** **US D818,841 S**

(45) **Date of Patent:** **** May 29, 2018**

(54) **BAG FOR A TRAY**

(71) Applicant: **Brian Newton**, Greensboro, NC (US)

(72) Inventor: **Brian Newton**, Greensboro, NC (US)

(**) Term: **15 Years**

(21) Appl. No.: **29/594,608**

(22) Filed: **Feb. 21, 2017**

(51) **LOC (11) Cl.** **09-05**

(52) **U.S. Cl.**
USPC **D9/702**

(58) **Field of Classification Search**

USPC D9/702-714, 499, 120-424, 430-434;
150/154; 229/125.22, 122, 124, 125.01,
229/125.05, 125.12, 125.125, 125.33,
229/125.34; 220/287, 4.21, 376;
206/223; D3/273, 274; D7/601-602,
D7/605, 629; 215/12.1, 13.1, 400;
426/106

CPC B65D 31/00; B65D 33/00; B65D 65/00;
B65D 65/02; B65D 65/10; B65D 71/00;
B65D 71/08; B65D 75/00; B65D 75/02;
B65D 75/04; B65D 75/28; B65D 51/00;
B65D 51/12

See application file for complete search history.

(56) **References Cited**

U.S. PATENT DOCUMENTS

D554,528 S * 11/2007 Brandon D9/705

8,905,258 B2 * 12/2014 Javid A47J 36/06

220/287

2004/0099666 A1 * 5/2004 Ordiway B65D 41/22

220/287

2009/0183807 A1 * 7/2009 Sadlier B65D 41/22

150/154

* cited by examiner

Primary Examiner — Abraham Bahta

(74) *Attorney, Agent, or Firm* — Tuggle Duggins P.A.;
Blake Hurt

(57) **CLAIM**

The ornamental design for a bag for a tray, as shown and described.

DESCRIPTION

FIG. 1 is a top, front, right side perspective view of a bag for a tray showing my new design;

FIG. 2 is a top plan view thereof;

FIG. 3 is a left side elevational view thereof, the right side elevational view being a mirror image thereof;

FIG. 4 is a rear elevational view thereof, the front elevational view being a mirror image thereof;

FIG. 5 is a bottom plan view thereof; and,

FIG. 6 is a bottom, rear, right side perspective view thereof.

The broken lines shown throughout the views depict unclaimed subject matter.

1 Claim, 6 Drawing Sheets

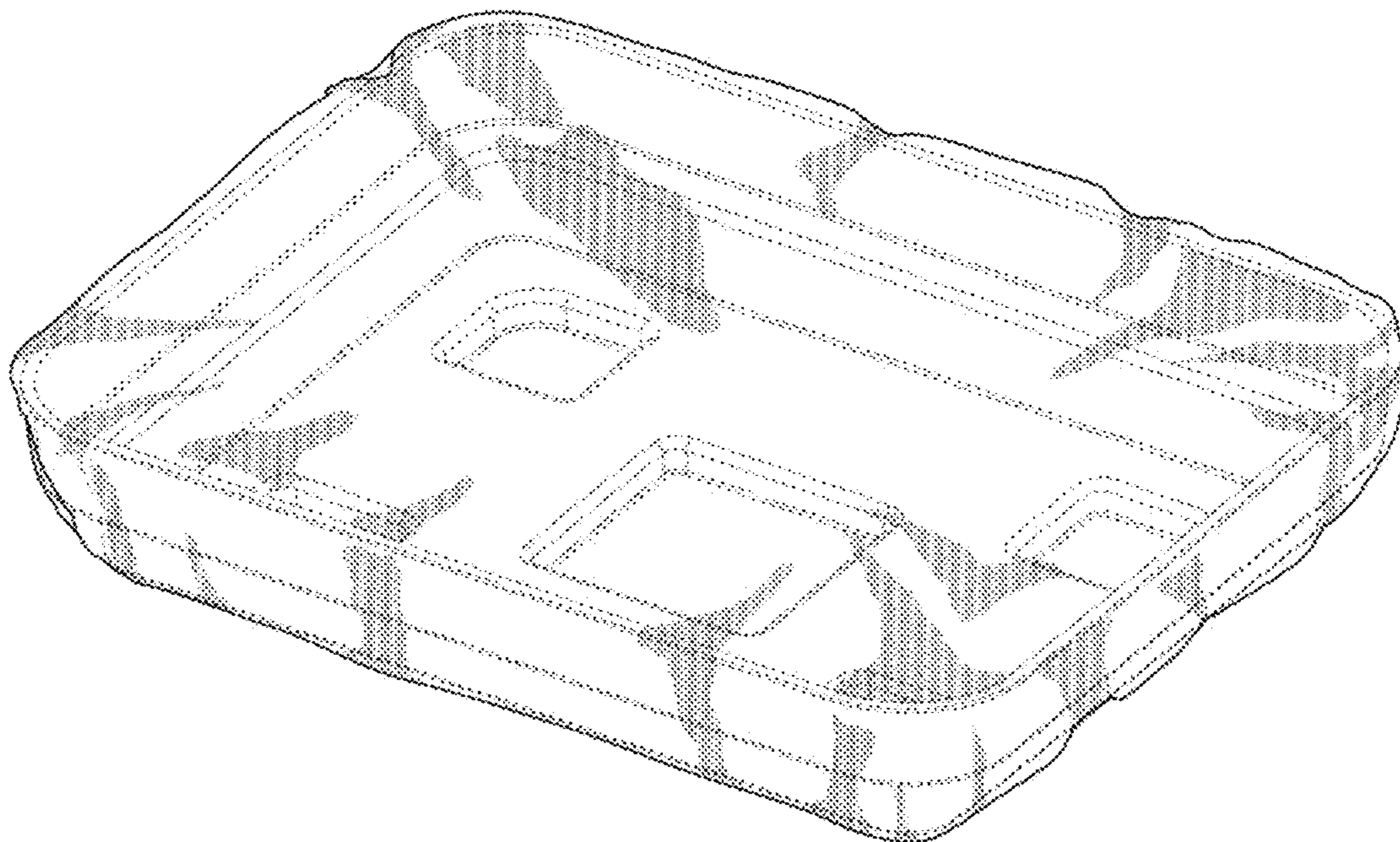

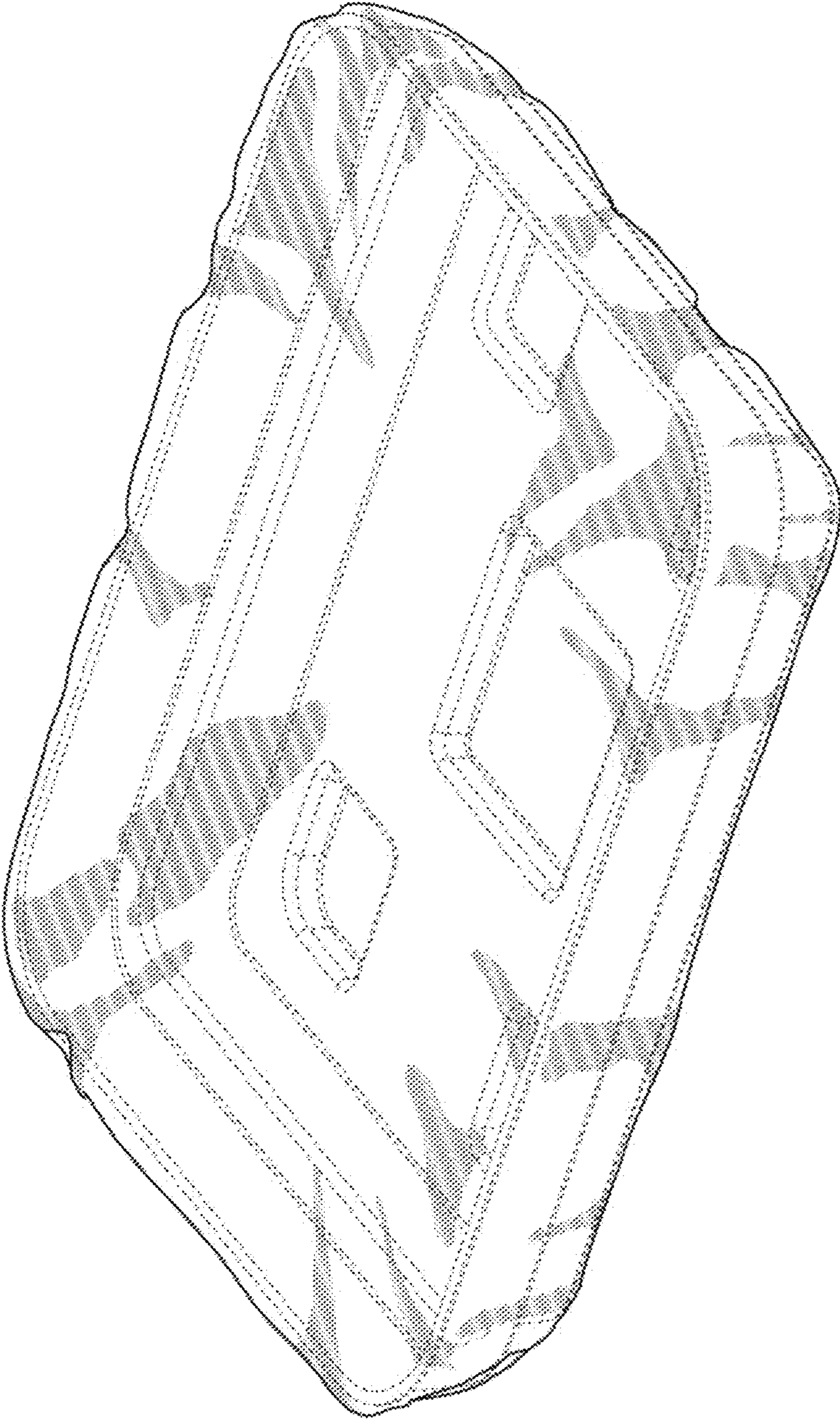

FIG. 1

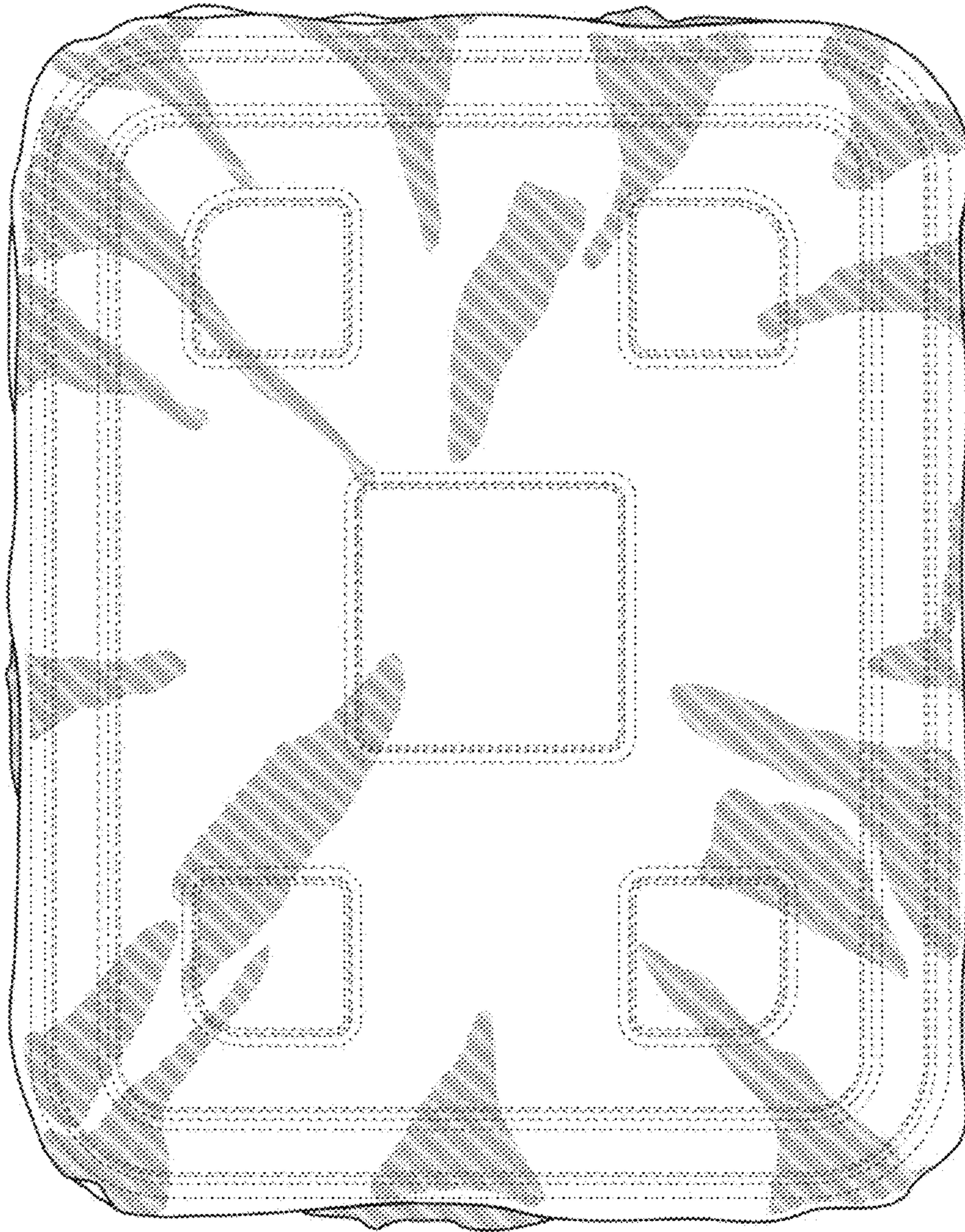

FIG. 2

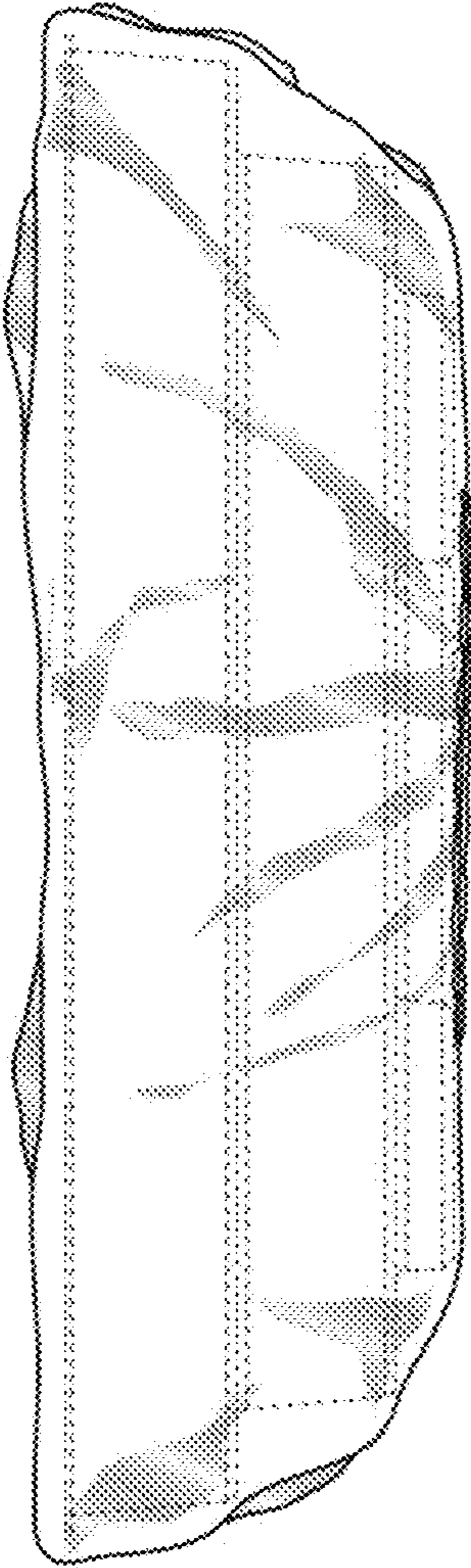

FIG. 3

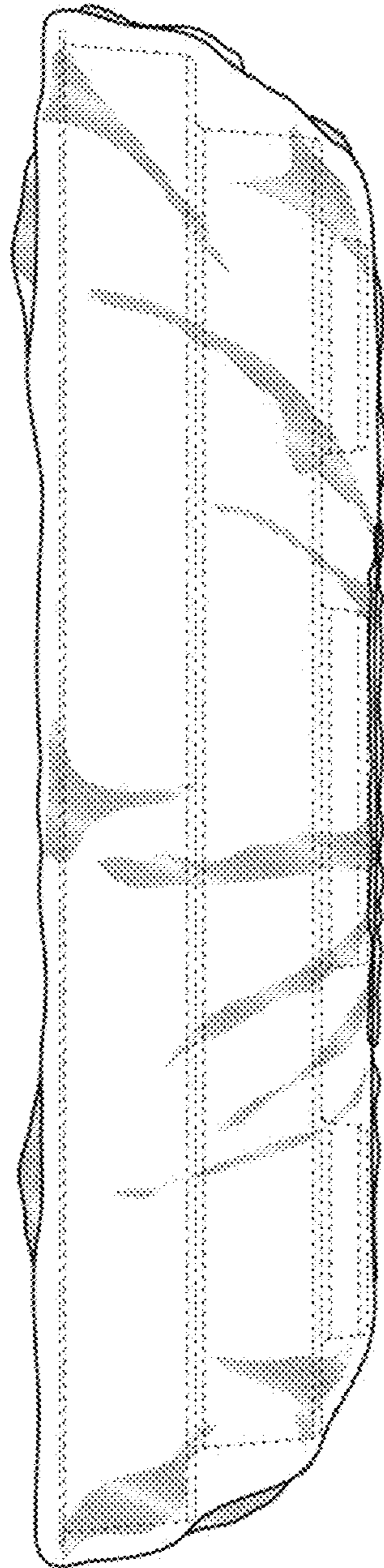

FIG. 4

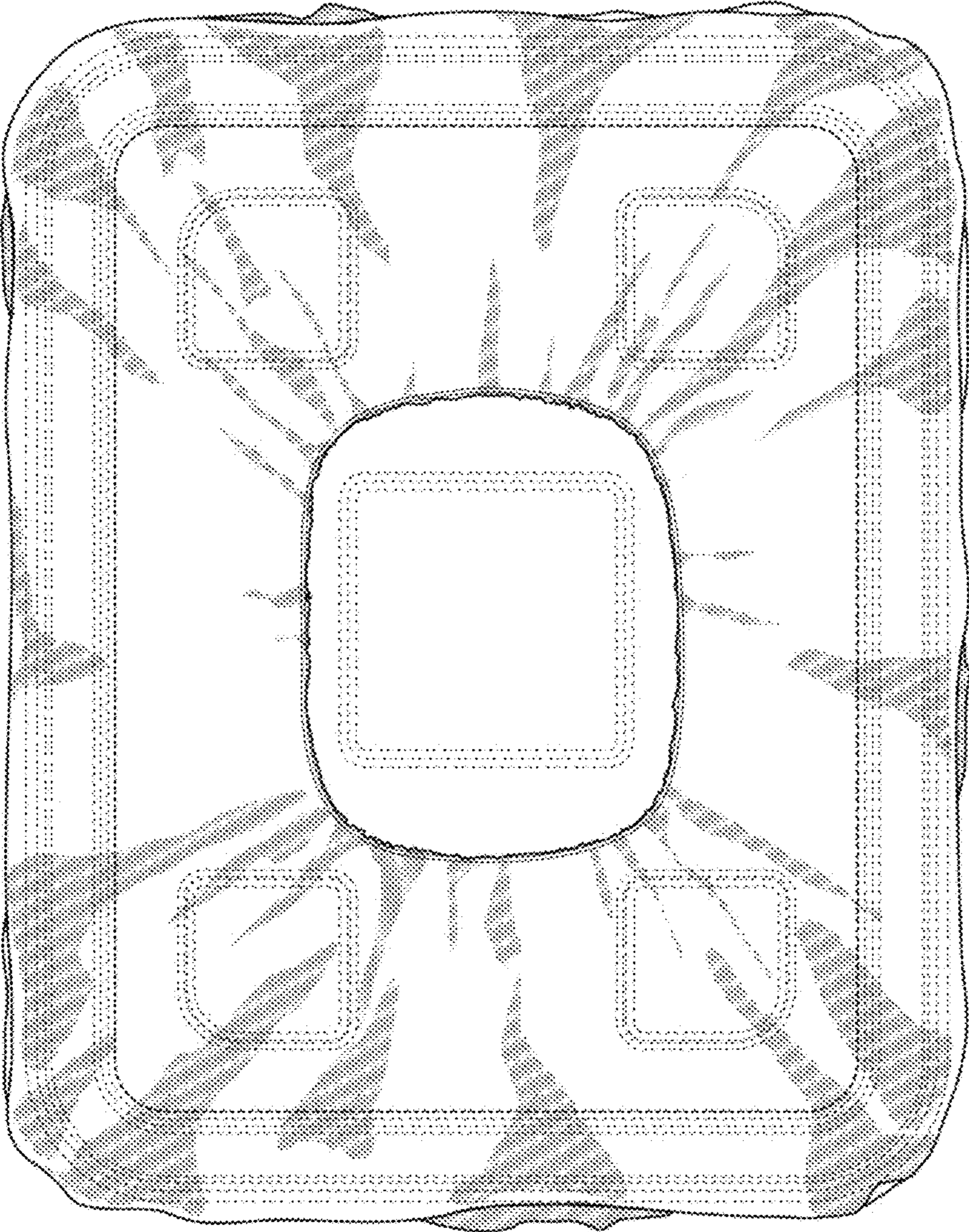

FIG. 5

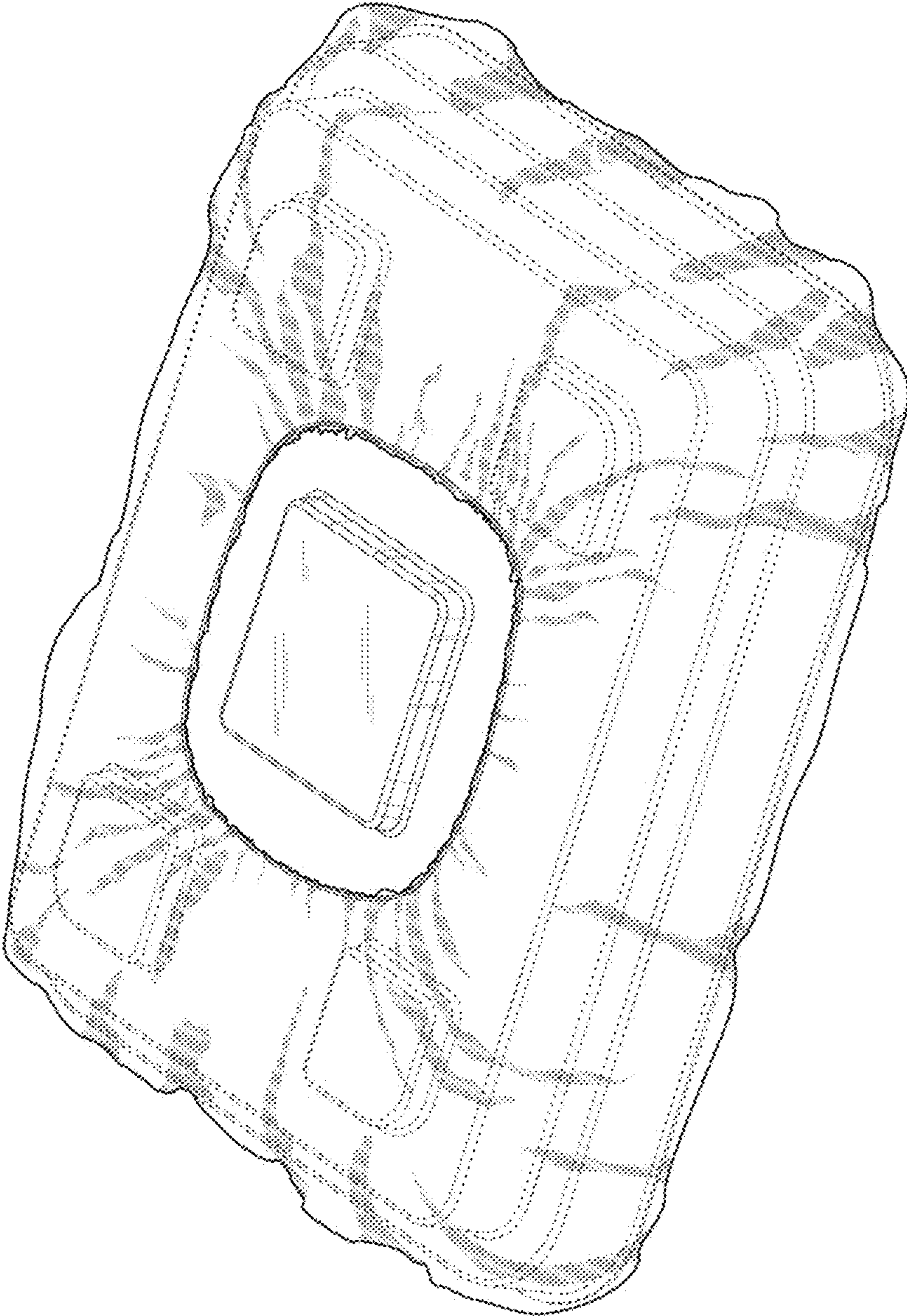

FIG. 6