



US00D818823S

(12) **United States Design Patent** (10) **Patent No.:** **US D818,823 S**
Blachford et al. (45) **Date of Patent:** **** May 29, 2018**

(54) **NOZZLE**
(71) Applicant: **GlaxoSmithKline Consumer Healthcare (UK) IP Limited**, Brentford, Middlesex (GB)
(72) Inventors: **Marcus James Blachford**, Warwickshire (GB); **Alex Brian**, Surrey (GB); **George Cave**, Warwickshire (GB); **James Senior**, Warwickshire (GB)

D286,380 S * 10/1986 Harman D9/447
D295,380 S * 4/1988 Virag D9/447
D383,065 S * 9/1997 Eastling D9/447
D447,949 S * 9/2001 Richardson D9/435
D529,603 S * 10/2006 Knickerbocker D24/110
D535,721 S * 1/2007 Ford D23/213
D575,639 S * 8/2008 Seeuwen D9/439
D595,538 S * 7/2009 Starck D7/396.1

(Continued)

(73) Assignee: **GlaxoSmithKline Consumer Healthcare (UK) IP Limited**, Brentford, Middlesex (GB)

OTHER PUBLICATIONS
NeoPac. News—Better Health, drop by drop. Jun. 1, 2017 [earliest online date], [site visited Dec. 21, 2017]. Available from Internet, <URL: <https://www.neopac.com/en/news-events>>. (Year: 2017).*

(Continued)

(**) Term: **15 Years**

Primary Examiner — Robert M. Spear
Assistant Examiner — Darcey E Heflin
(74) *Attorney, Agent, or Firm* — Roshni A. Sitapara; Joshua C. Sanders

(21) Appl. No.: **29/591,877**

(22) Filed: **Jan. 25, 2017**

(30) **Foreign Application Priority Data**

Jul. 28, 2016 (GB) 4045692

(51) **LOC (11) Cl.** **09-07**

(52) **U.S. Cl.**
USPC **D9/447**

(58) **Field of Classification Search**
USPC D3/202, 203.1, 242; D7/316, 321, 392.1, D7/396.2, 397, 500, 507, 509–511; D9/434–437, 439, 440, 442–445, 447, D9/448, 449, 450, 452–455, 499, 682, D9/685, 694; D23/213, 227, 233, 255, D23/260, 269, 390
CPC B65D 47/06; B65D 83/14; B65D 83/306; B05B 9/01
See application file for complete search history.

(56) **References Cited**

U.S. PATENT DOCUMENTS

884,761 A * 4/1908 Richard B65D 47/265
222/542
D223,339 S * 4/1972 Marg D9/436

(57) **CLAIM**

The ornamental design for a nozzle, as shown and described.

DESCRIPTION

FIG. 1 is a front perspective view from top and left side; FIG. 2 is a front view; FIG. 3 is a back view; FIG. 4 is a left side view; FIG. 5 is a right side view; FIG. 6 is a top view; and, FIG. 7 is a bottom view.
The broken lines shown in the drawings illustrate features of the article to which the design is applied or in which the design is embodied that form no part of the claim.

1 Claim, 4 Drawing Sheets

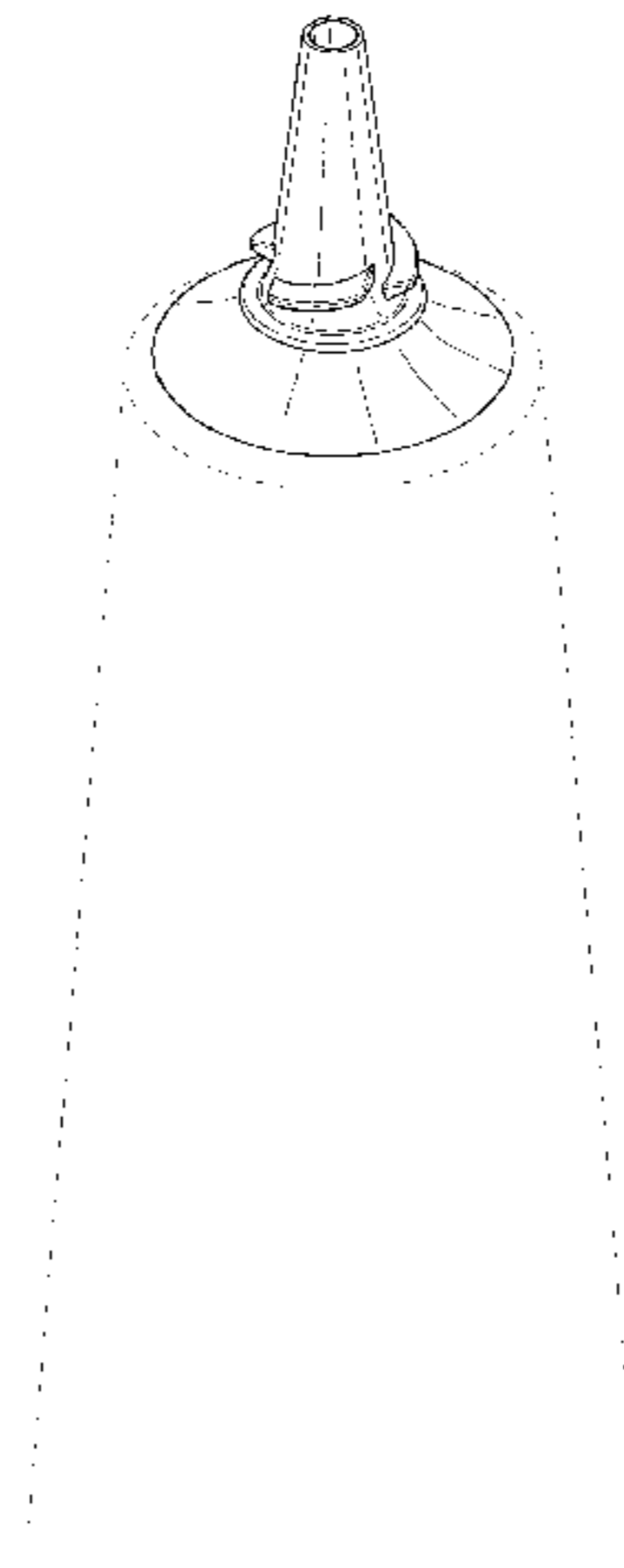

(56)

References Cited

U.S. PATENT DOCUMENTS

D633,384 S * 3/2011 Tanaka D9/447
D703,045 S * 4/2014 Stathos D9/436
D718,128 S * 11/2014 Greathouse D9/440
9,669,970 B2 * 6/2017 Martinez Carregui
..... B65D 47/20
9,790,008 B2 * 10/2017 Martinez Carregui
..... B65D 47/40

OTHER PUBLICATIONS

Monotaro. Eye Drop Bottle C Screw Nozzle. Jun. 4, 2016 [earliest
online date], [site visited Dec. 21, 2017]. Available from Internet,
<URL: <http://www.monotaro.sg/g/00496499/>>. (Year: 2016).*

* cited by examiner

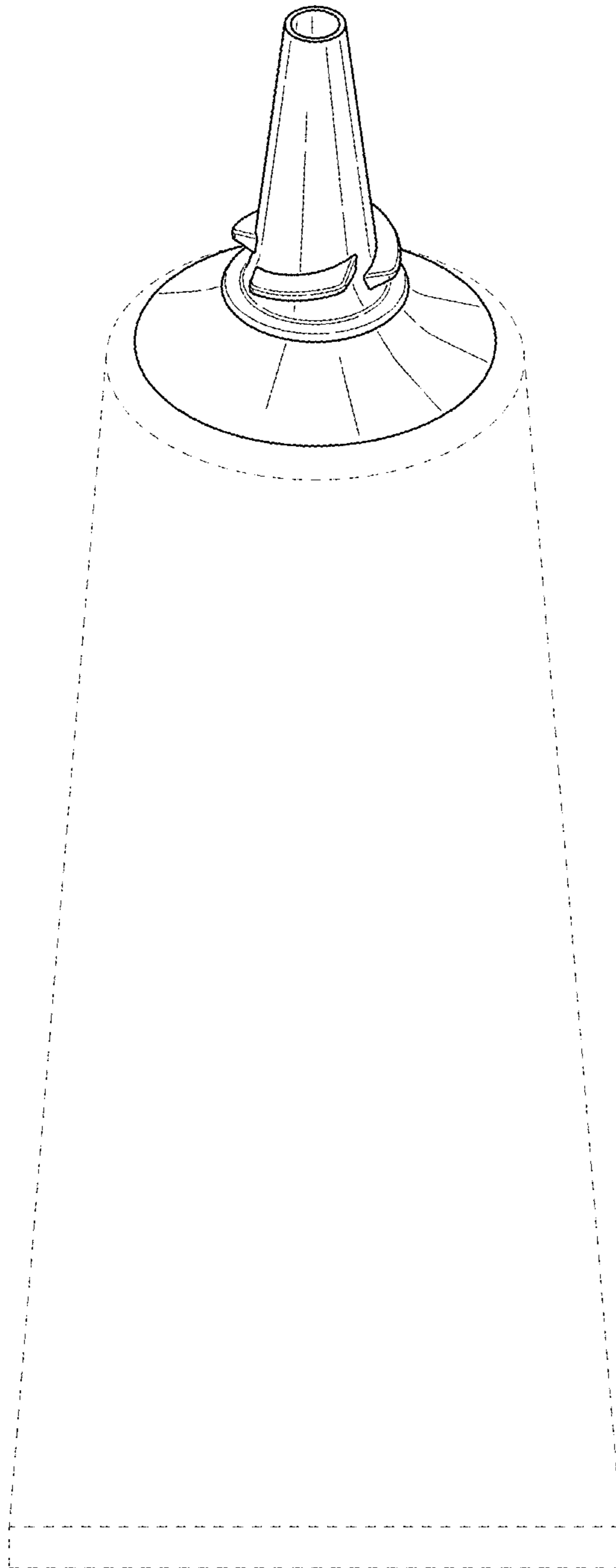

Fig. 1

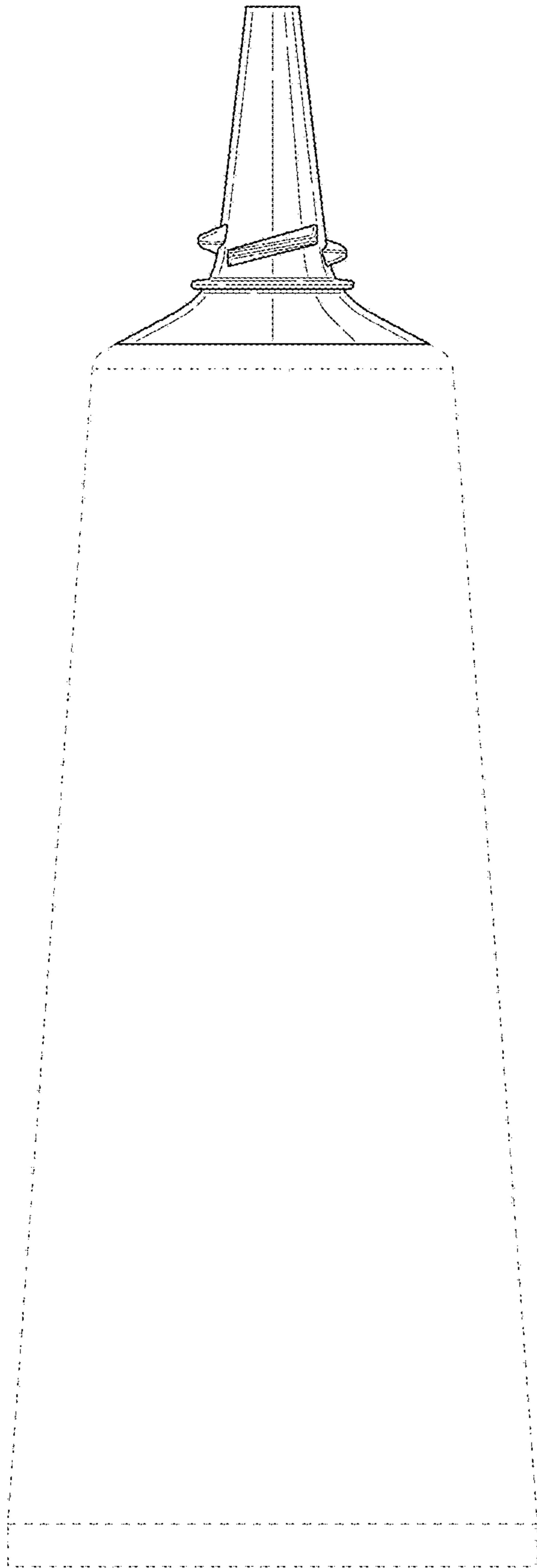

Fig. 2

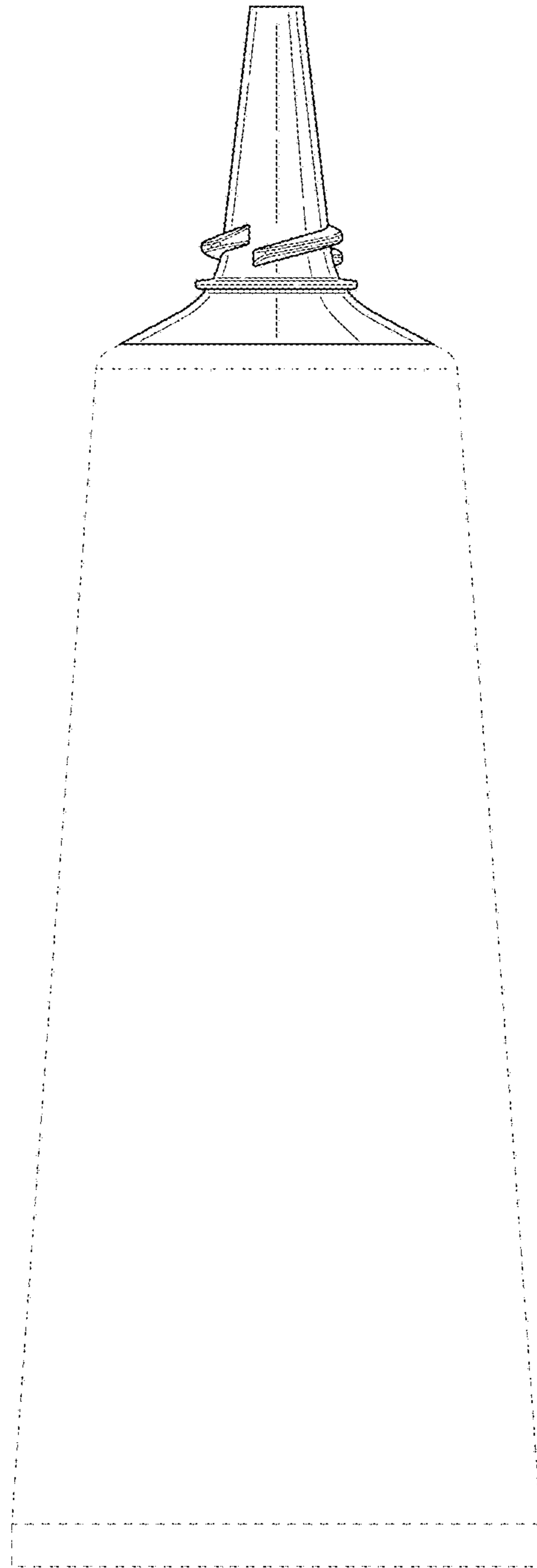

Fig. 3

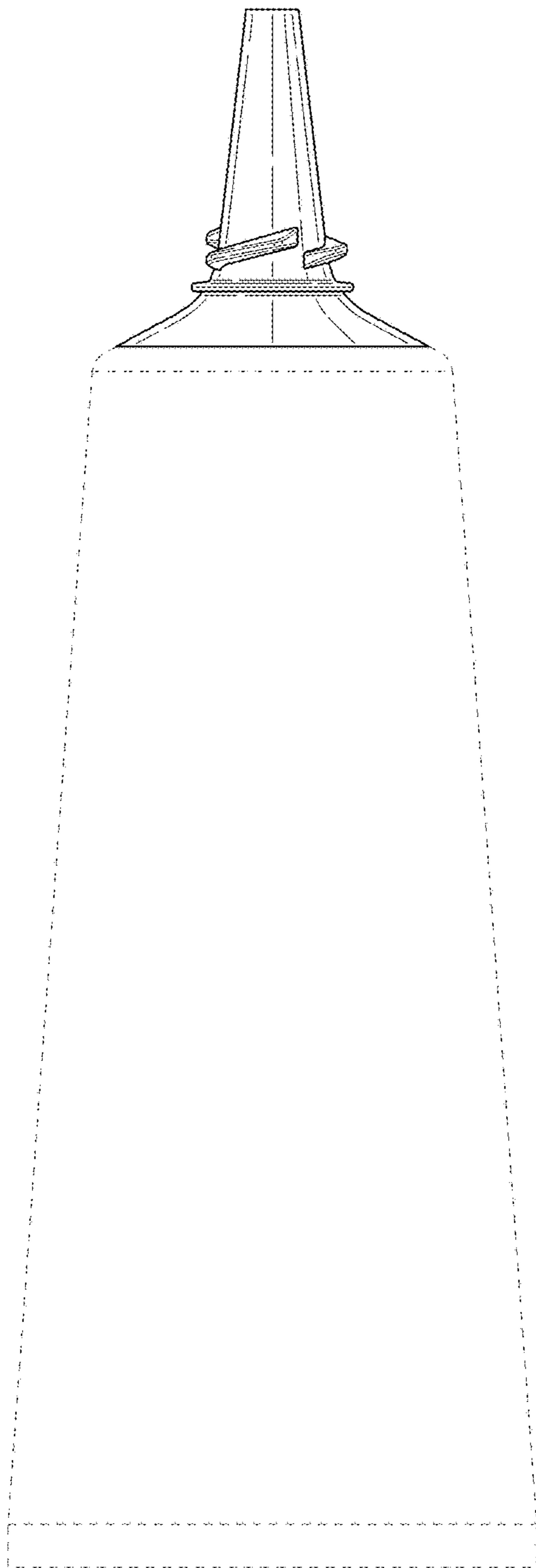

Fig. 4

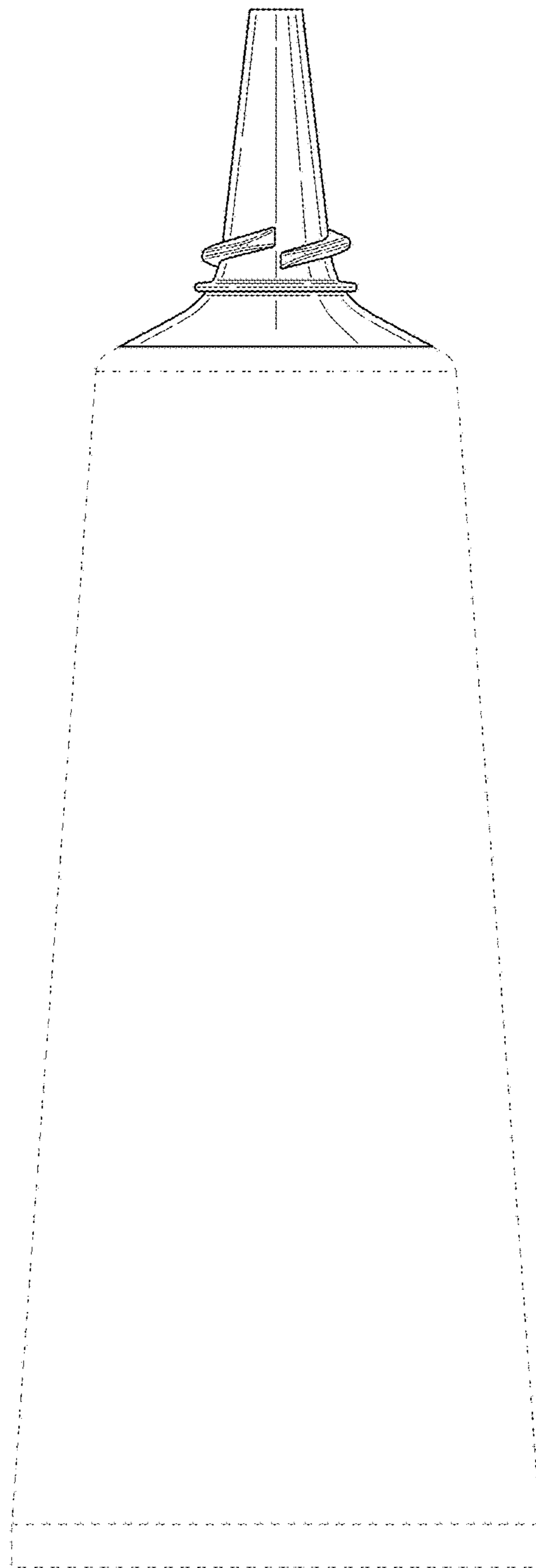

Fig. 5

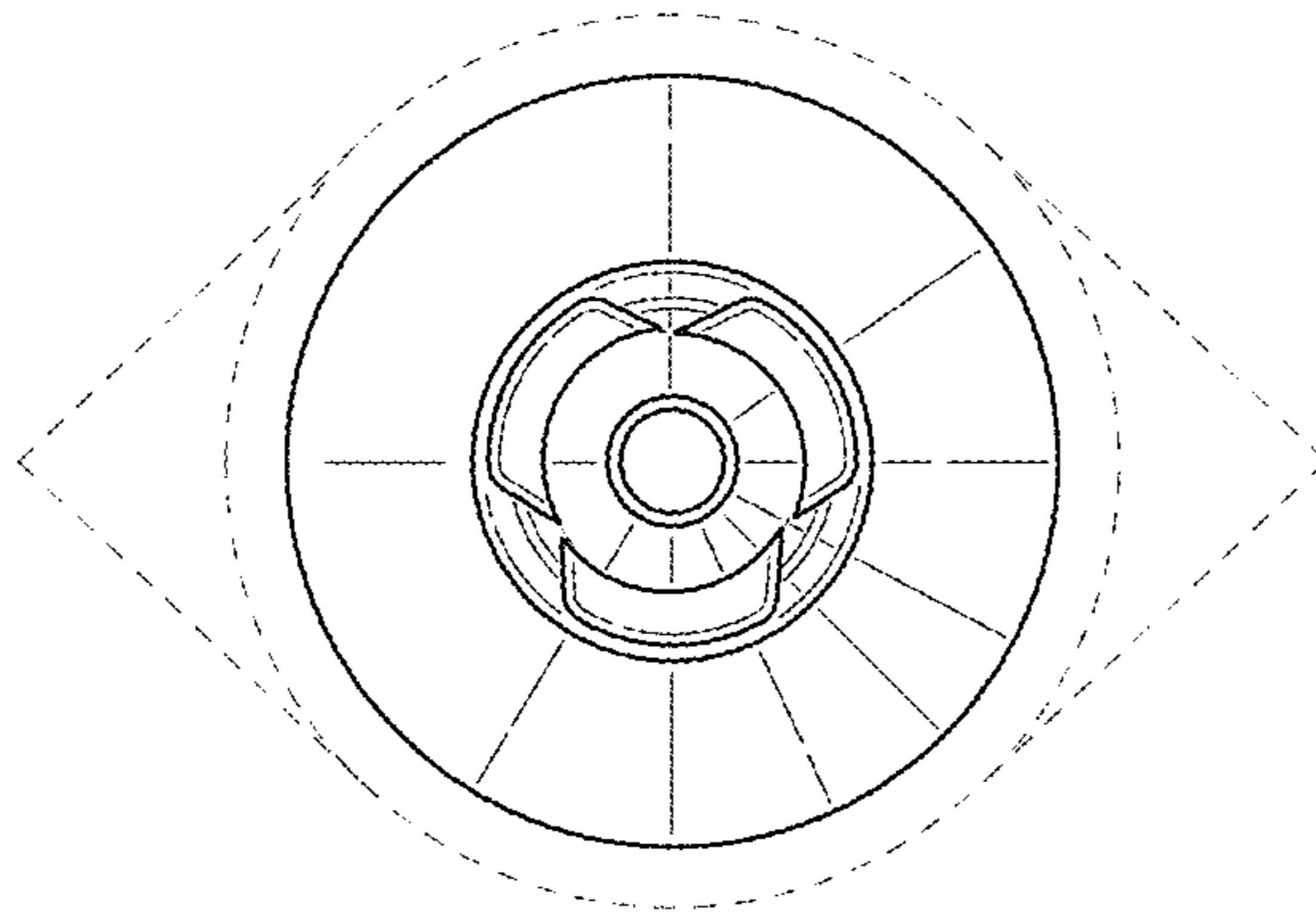

Fig. 6

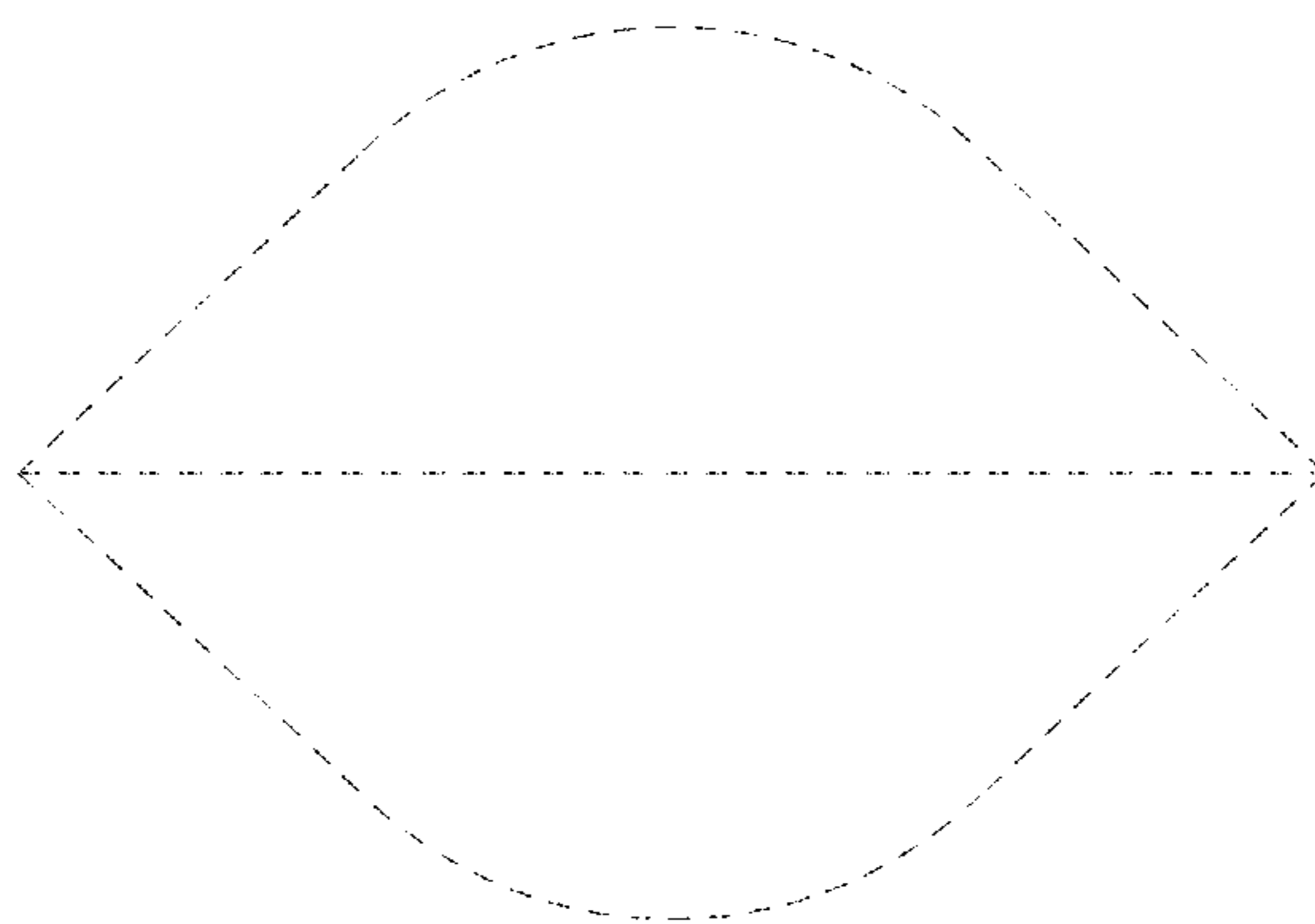

Fig. 7